



# **JBoss Enterprise Application Platform 5**

## **Administration and Configuration Guide**

for JBoss Enterprise Application Platform 5

Edition 5.2.0

Last Updated: 2017-10-12



# JBoss Enterprise Application Platform 5 Administration and Configuration Guide

---

for JBoss Enterprise Application Platform 5  
Edition 5.2.0

JBoss Community

## **Edited by**

Eva Kopalova

Petr Penicka

Russell Dickenson

Scott Mumford

## Legal Notice

Copyright © 2012 Red Hat, Inc.

This document is licensed by Red Hat under the [Creative Commons Attribution-ShareAlike 3.0 Unported License](#). If you distribute this document, or a modified version of it, you must provide attribution to Red Hat, Inc. and provide a link to the original. If the document is modified, all Red Hat trademarks must be removed.

Red Hat, as the licensor of this document, waives the right to enforce, and agrees not to assert, Section 4d of CC-BY-SA to the fullest extent permitted by applicable law.

Red Hat, Red Hat Enterprise Linux, the Shadowman logo, JBoss, OpenShift, Fedora, the Infinity logo, and RHCE are trademarks of Red Hat, Inc., registered in the United States and other countries.

Linux ® is the registered trademark of Linus Torvalds in the United States and other countries.

Java ® is a registered trademark of Oracle and/or its affiliates.

XFS ® is a trademark of Silicon Graphics International Corp. or its subsidiaries in the United States and/or other countries.

MySQL ® is a registered trademark of MySQL AB in the United States, the European Union and other countries.

Node.js ® is an official trademark of Joyent. Red Hat Software Collections is not formally related to or endorsed by the official Joyent Node.js open source or commercial project.

The OpenStack ® Word Mark and OpenStack logo are either registered trademarks/service marks or trademarks/service marks of the OpenStack Foundation, in the United States and other countries and are used with the OpenStack Foundation's permission. We are not affiliated with, endorsed or sponsored by the OpenStack Foundation, or the OpenStack community.

All other trademarks are the property of their respective owners.

## Abstract

This book is a guide to the administration and configuration of JBoss Enterprise Application Platform 5 and its patch releases.

## Table of Contents

<b>PART I. OVERVIEW</b> .....	<b>13</b>
<b>CHAPTER 1. SCOPE OF BOOK</b> .....	<b>14</b>
<b>CHAPTER 2. INTRODUCTION</b> .....	<b>15</b>
2.1. INTEGRATED PROJECTS	15
2.2. ARCHITECTURE	16
2.3. DIRECTORY STRUCTURE	17
2.4. JBOSS ENTERPRISE APPLICATION PLATFORM USE CASES	19
2.5. BOOTSTRAP	19
2.6. HOT DEPLOYMENT	20
2.6.1. Adding a Custom Deploy Folder	21
<b>PART II. JBOSS ENTERPRISE APPLICATION PLATFORM CONFIGURATION</b> .....	<b>23</b>
<b>CHAPTER 3. NETWORK</b> .....	<b>24</b>
3.1. IPV6 SUPPORT	24
<b>CHAPTER 4. JBOSS WEB</b> .....	<b>25</b>
4.1. SYSTEM PROPERTIES	25
4.1.1. Modifying System Properties	29
4.2. CONFIGURING THE JBOSS WEB CONTAINER	29
4.3. THE MAIN CONFIG FILE	29
4.4. TOP-LEVEL ELEMENTS	31
4.4.1. Server	31
4.4.2. Service	31
4.5. CONNECTOR	32
4.5.1. Executor	32
4.6. CONTAINERS	34
4.6.1. Engine	34
4.6.2. Host	35
4.6.2.1. Defining Host Name Aliases	37
4.6.3. Context	38
4.6.3.1. Defining Context	38
Context FAQs	42
Context FAQs	42
4.7. NESTED COMPONENTS	45
4.7.1. Realm	45
4.7.2. Valve	45
4.7.3. GlobalNamingResources	45
<b>CHAPTER 5. ENTERPRISE APPLICATIONS WITH EJB3 SERVICES</b> .....	<b>47</b>
5.1. SESSION BEANS	47
5.2. ENTITY BEANS (A.K.A. JAVA PERSISTENCE API)	49
5.2.1. The persistence.xml file	51
5.2.2. Use Alternative Databases	52
5.2.3. Default Hibernate Options	53
5.3. MESSAGE DRIVEN BEANS	54
5.4. PACKAGE AND DEPLOY EJB3 SERVICES	55
5.4.1. Deploy the EJB3 JAR	55
5.4.2. Deploy EAR with EJB3 JAR	56
<b>CHAPTER 6. LOGGING</b> .....	<b>59</b>

6.1. LOGGING DEFAULTS	59
6.2. COMPONENT-SPECIFIC LOGGING	60
6.2.1. SQL Logging with Hibernate	60
6.2.2. Transaction Service Logging	60
<b>CHAPTER 7. DEPLOYMENT</b>	<b>61</b>
7.1. DEPLOYABLE APPLICATION TYPES	61
7.1.1. Exploded Deployment	63
7.2. STANDARD SERVER PROFILES	63
7.2.1. Changing Profile	64
7.2.2. Creating Your Own Profile	65
7.3. CONTEXT ROOT	65
<b>CHAPTER 8. MICROCONTAINER</b>	<b>67</b>
<b>CHAPTER 9. THE JNDI NAMING SERVICE</b>	<b>68</b>
9.1. AN OVERVIEW OF JNDI	68
9.1.1. Names	68
9.1.2. Contexts	69
9.1.2.1. Obtaining a Context using InitialContext	69
9.2. THE JBOSS NAMING SERVICE ARCHITECTURE	70
9.3. THE NAMING INITIALCONTEXT FACTORIES	72
9.3.1. The standard naming context factory	73
9.3.2. The org.jboss.naming.NamingContextFactory	74
9.3.3. Naming Discovery in Clustered Environments	74
9.3.4. The HTTP InitialContext Factory Implementation	75
9.3.5. The Login InitialContext Factory Implementation	76
9.3.6. The ORBInitialContextFactory	76
9.4. JNDI OVER HTTP	77
9.4.1. Accessing JNDI over HTTP	77
9.4.2. Accessing JNDI over HTTPS	80
9.4.3. Securing Access to JNDI over HTTP	82
9.4.4. Securing Access to JNDI with a Read-Only Unsecured Context	84
9.5. ADDITIONAL NAMING MBEANS	86
9.5.1. JNDI Binding Manager	86
9.5.2. The org.jboss.naming.NamingAlias MBean	88
9.5.3. org.jboss.naming.ExternalContext MBean	88
9.5.4. The org.jboss.naming.JNDIView MBean	90
9.6. J2EE AND JNDI - THE APPLICATION COMPONENT ENVIRONMENT	93
9.6.1. ENC Usage Conventions	94
9.6.1.1. Environment Entries	95
9.6.1.2. EJB References	96
9.6.1.3. EJB References with jboss.xml and jboss-web.xml	98
9.6.1.4. EJB Local References	99
9.6.1.5. Resource Manager Connection Factory References	101
9.6.1.6. Resource Manager Connection Factory References with jboss.xml and jboss-web.xml	102
9.6.1.7. Resource Environment References	103
9.6.1.8. Resource Environment References and jboss.xml, jboss-web.xml	104
<b>CHAPTER 10. WEB SERVICES</b>	<b>106</b>
10.1. THE NEED FOR WEB SERVICES	106
10.2. WHAT WEB SERVICES ARE NOT	106
10.3. DOCUMENT/LITERAL	107
10.4. DOCUMENT/LITERAL (BARE)	107

---

10.5. DOCUMENT/LITERAL (WRAPPED)	108
10.6. RPC/LITERAL	108
10.7. RPC/ENCODED	110
10.8. WEB SERVICE ENDPOINTS	110
10.9. PLAIN OLD JAVA OBJECT (POJO)	110
10.10. THE ENDPOINT AS A WEB APPLICATION	110
10.11. PACKAGING THE ENDPOINT	111
10.12. ACCESSING THE GENERATED WSDL	111
10.13. EJB3 STATELESS SESSION BEAN (SLSB)	111
10.14. ENDPOINT PROVIDER	112
10.15. WEBSERVICECONTEXT	113
10.16. WEB SERVICE CLIENTS	113
10.16.1. Service	113
10.16.1.1. Service Usage	113
10.16.1.2. Handler Resolver	114
10.16.1.3. Executor	115
10.16.2. Dynamic Proxy	115
10.16.3. WebServiceRef	116
10.16.4. Dispatch	117
10.16.5. Asynchronous Invocations	118
10.16.6. Oneway Invocations	118
10.17. COMMON API	119
10.17.1. Handler Framework	119
10.17.1.1. Logical Handler	119
10.17.1.2. Protocol Handler	119
10.17.1.3. Service endpoint handlers	120
10.17.1.4. Service client handlers	120
10.17.2. Message Context	120
10.17.2.1. Accessing the message context	120
10.17.2.2. Logical Message Context	121
10.17.2.3. SOAP Message Context	121
10.17.3. Fault Handling	121
10.18. DATABINDING	121
10.18.1. Using JAXB with non annotated classes	121
10.19. ATTACHMENTS	122
10.19.1. MTOM/XOP	122
10.19.1.1. Supported MTOM parameter types	122
10.19.1.2. Enabling MTOM per endpoint	122
10.19.2. SwaRef	123
10.19.2.1. Using SwaRef with JAX-WS endpoints	123
10.19.2.2. Starting from WSDL	125
10.20. TOOLS	125
10.20.1. Bottom-Up (Using wsprovide)	125
10.20.2. Top-Down (Using wsconsume)	127
10.20.3. Client Side	129
10.20.4. Command-line & Ant Task Reference	132
10.20.5. JAX-WS binding customization	132
10.21. WEB SERVICE EXTENSIONS	132
10.21.1. WS-Addressing	132
10.21.1.1. Specifications	132
10.21.1.2. Addressing Endpoint	132
10.21.1.3. Addressing Client	133
10.21.2. WS-Security	135

---

10.21.2.1. Endpoint configuration	135
10.21.2.2. Server side WSSE declaration (jboss-wsse-server.xml)	135
10.21.2.3. Client side WSSE declaration (jboss-wsse-client.xml)	137
10.21.2.3.1. Client side key store configuration	138
10.21.2.4. Installing the BouncyCastle JCE provider	138
10.21.2.5. Username Token Authentication	139
10.21.2.5.1. Secure Transport	142
10.21.2.6. X509 Certificate Token	142
10.21.2.7. JAAS Integration	146
10.21.2.8. POJO Endpoint Authentication and Authorization	148
10.21.3. XML Registries	149
10.21.3.1. Apache jUDDI Configuration	149
10.21.3.2. JBoss JAXR Configuration	150
10.21.3.3. JAXR Sample Code	151
10.21.3.4. Troubleshooting	154
10.21.3.5. Resources	154
10.22. JBOSSWS EXTENSIONS	154
10.22.1. Proprietary Annotations	154
10.22.1.1. EndpointConfig	154
10.22.1.2. WebContext	155
10.22.1.3. SecurityDomain	156
10.23. WEB SERVICES APPENDIX	157
10.24. REFERENCES	157
<b>CHAPTER 11. ADDITIONAL SERVICES</b>	<b>158</b>
11.1. EXPOSING MBEAN EVENTS VIA SNMP	158
<b>CHAPTER 12. JBOSS AOP</b>	<b>160</b>
12.1. SOME KEY TERMS	160
12.2. CREATING ASPECTS IN JBOSS AOP	161
12.3. APPLYING ASPECTS IN JBOSS AOP	162
12.4. PACKAGING AOP APPLICATIONS	164
12.5. THE JBOSS ASPECTMANAGER SERVICE	165
12.6. LOADTIME TRANSFORMATION IN THE JBOSS ENTERPRISE APPLICATION PLATFORM USING SUN JDK	166
12.7. JROCKIT	166
12.8. IMPROVING LOADTIME PERFORMANCE IN THE JBOSS ENTERPRISE APPLICATION PLATFORM ENVIRONMENT	167
12.9. SCOPING THE AOP TO THE CLASSLOADER	167
12.9.1. Deploying as part of a scoped classloader	167
12.9.2. Attaching to a scoped deployment	168
<b>CHAPTER 13. TRANSACTION MANAGEMENT</b>	<b>169</b>
13.1. OVERVIEW	169
13.2. CONFIGURATION ESSENTIALS	169
13.3. TRANSACTIONAL RESOURCES	172
13.4. LAST RESOURCE COMMIT OPTIMIZATION (LRCO)	173
13.5. TRANSACTION TIMEOUT HANDLING	173
13.6. RECOVERY CONFIGURATION	173
13.7. TRANSACTION SERVICE FAQ	173
13.8. USING THE JTS MODULE	174
13.9. USING THE XTS MODULE	175
13.10. TRANSACTION MANAGEMENT CONSOLE	175
13.11. EXPERIMENTAL COMPONENTS	175



13.12. SOURCE CODE AND UPGRADING	176
<b>CHAPTER 14. REMOTING</b> .....	<b>178</b>
14.1. BACKGROUND	178
14.2. JBOSS REMOTING CONFIGURATION	178
14.2.1. MBeans	178
14.2.2. POJOs	179
14.3. MULTIHOMED SERVERS	180
14.4. ADDRESS TRANSLATION	181
14.5. WHERE ARE THEY NOW?	182
14.6. FURTHER INFORMATION.	182
<b>CHAPTER 15. MESSAGING</b> .....	<b>183</b>
15.1. DEFAULT JMS MESSAGING PROVIDERS	183
15.2. IBM WEBSHERE MQ INTEGRATION	183
15.2.1. Configuring WebSphere MQ Integration	183
15.2.1.1. Using the WebSphere MQ resource adapter in an MDB	186
15.2.1.2. Configuration for XA Transaction Recovery	187
<b>CHAPTER 16. USING PRODUCTION DATABASES WITH JBOSS ENTERPRISE APPLICATION PLATFORM</b>	<b>192</b>
16.1. HOW TO USE PRODUCTION DATABASES	192
16.2. INSTALLING JDBC DRIVERS	192
16.2.1. Special Notes on Sybase	193
16.2.1.1. Enable JAVA services	193
16.2.1.2. CMP Configuration	193
16.2.1.3. Installing Java Classes	194
16.2.1.4. Increase @@textsize Default for Sybase v15.0.3	194
16.2.2. Configuring JDBC DataSources	194
16.3. SWITCHING TO A PRODUCTION DATABASE	194
16.4. COMMON DATABASE-RELATED TASKS	196
16.4.1. Security and Pooling	196
16.4.2. Change Database for the JMS Services	196
16.4.3. Support Foreign Keys in CMP Services	196
16.4.4. Specify Database Dialect for Java Persistence API	197
16.4.5. Change Other JBoss Enterprise Application Platform Services to use the External Database	197
16.4.5.1. The Easy Way	197
16.4.5.2. The More Flexible Way	198
16.4.6. A Special Note About Oracle Databases	198
<b>CHAPTER 17. DATASOURCE CONFIGURATION</b> .....	<b>200</b>
17.1. TYPES OF DATASOURCES	200
17.2. DATASOURCE PARAMETERS	201
17.3. DATASOURCE EXAMPLES	207
17.3.1. Generic Datasource Example	207
17.3.2. Configuring a DataSource for Remote Usage	209
17.3.3. Configuring a Datasource to Use Login Modules	210
<b>CHAPTER 18. POOLING</b> .....	<b>212</b>
18.1. STRATEGY	212
18.2. WORKAROUND FOR ORACLE'S JDK	212
18.3. POOL ACCESS	212
18.4. POOL FILLING	213
18.5. IDLE CONNECTIONS	213
18.6. DEAD CONNECTIONS	213

18.6.1. Valid connection checking	213
18.6.2. Errors during SQL queries	214
18.6.3. Changing, Closing or Flushing the pool	214
18.6.4. Using Third Party Pools	214
<b>PART III. CLUSTERING GUIDE</b>	<b>216</b>
<b>CHAPTER 19. INTRODUCTION AND QUICK START</b>	<b>217</b>
19.1. QUICK START GUIDE	217
19.1.1. Initial Preparation	217
19.1.2. Launching a JBoss Enterprise Application Platform Cluster	219
19.1.3. Web Application Clustering Quick Start	221
19.1.4. EJB Session Bean Clustering Quick Start	221
19.1.5. Entity Clustering Quick Start	222
<b>CHAPTER 20. CLUSTERING CONCEPTS</b>	<b>224</b>
20.1. CLUSTER DEFINITION	224
20.2. SERVICE ARCHITECTURES	225
20.2.1. Client-side interceptor architecture	225
20.2.2. External Load Balancer Architecture	226
20.3. LOAD BALANCING POLICIES	227
20.3.1. Client-side interceptor architecture	227
20.3.2. External load balancer architecture	228
<b>CHAPTER 21. CLUSTERING BUILDING BLOCKS</b>	<b>229</b>
21.1. GROUP COMMUNICATION WITH JGROUPS	230
21.1.1. The Channel Factory Service	230
21.1.1.1. Standard Protocol Stack Configurations	230
21.1.1.2. Changing the Protocol Stack Configuration	232
21.1.1.3. Changing the Protocol Stack Configuration of JBoss Messaging	232
21.1.2. The JGroups Shared Transport	233
21.2. DISTRIBUTED CACHING WITH JBOSS CACHE	234
21.2.1. The JBoss Enterprise Application Platform CacheManager Service	235
21.2.1.1. Standard Cache Configurations	235
21.2.1.2. Cache Configuration Aliases	237
21.3. THE HAPARTITION SERVICE	238
21.3.1. DistributedReplicantManager Service	240
21.3.2. DistributedState Service	241
21.3.3. Custom Use of HAPartition	241
<b>CHAPTER 22. CLUSTERED JNDI SERVICES</b>	<b>242</b>
22.1. HOW IT WORKS	242
22.2. CLIENT CONFIGURATION	244
22.2.1. For clients running inside the Enterprise Application Platform	244
22.2.1.1. Accessing HA-JNDI Resources from EJBs and WARs -- Environment Naming Context	245
22.2.1.2. Why do this programmatically and not just put this in a jndi.properties file?	246
22.2.1.3. How can I tell if things are being bound into HA-JNDI that should not be?	246
22.2.2. For clients running outside the Enterprise Application Platform	246
22.3. JBOSS CONFIGURATION	247
22.3.1. Adding a Second HA-JNDI Service	251
<b>CHAPTER 23. CLUSTERED SESSION EJBs</b>	<b>253</b>
23.1. STATELESS SESSION BEAN IN EJB 3.0	253
23.2. STATEFUL SESSION BEANS IN EJB 3.0	254
23.2.1. The EJB application configuration	254

23.2.2. Optimize state replication	256
23.2.3. CacheManager service configuration	256
23.3. STATELESS SESSION BEAN IN EJB 2.X	259
23.4. STATEFUL SESSION BEAN IN EJB 2.X	260
23.4.1. The EJB application configuration	260
23.4.2. Optimize state replication	260
23.4.3. The HASessionStateService configuration	261
23.4.4. Handling Cluster Restart	261
23.4.5. JNDI Lookup Process	262
23.4.6. SingleRetryInterceptor	263
<b>CHAPTER 24. CLUSTERED ENTITY EJBS</b>	<b>264</b>
24.1. ENTITY BEAN IN EJB 3.0	264
24.1.1. Configure the distributed cache	264
24.1.2. Configure the entity beans for cache	267
24.1.3. Query result caching	269
24.2. ENTITY BEANS IN EJB 2.X	272
<b>CHAPTER 25. HTTP SERVICES</b>	<b>274</b>
<b>CHAPTER 26. JBOSS MESSAGING CLUSTERING NOTES</b>	<b>275</b>
<b>CHAPTER 27. CLUSTERED DEPLOYMENT OPTIONS</b>	<b>276</b>
27.1. CLUSTERED SINGLETON SERVICES	276
27.1.1. HASingleton Deployment Options	277
27.1.1.1. HASingletonDeployer service	277
27.1.1.2. POJO deployments using HASingletonController	278
27.1.1.3. HASingleton deployments using a Barrier	279
27.1.2. Determining the master node	280
27.1.2.1. HA singleton election policy	281
27.2. FARMING DEPLOYMENT	281
<b>CHAPTER 28. JGROUPS SERVICES</b>	<b>284</b>
28.1. CONFIGURING A JGROUPS CHANNEL'S PROTOCOL STACK	284
28.1.1. Common Configuration Properties	286
28.1.2. Transport Protocols	287
28.1.2.1. UDP configuration	287
28.1.2.2. TCP configuration	290
28.1.2.3. TUNNEL configuration	291
28.1.3. Discovery Protocols	292
28.1.3.1. PING	292
28.1.3.2. TCPGOSSIP	293
28.1.3.3. TCPPING	293
28.1.3.4. MPING	294
28.1.4. Failure Detection Protocols	295
28.1.4.1. FD	295
28.1.4.2. FD_SOCK	295
28.1.4.3. VERIFY_SUSPECT	296
28.1.4.4. FD versus FD_SOCK	296
28.1.5. Reliable Delivery Protocols	297
28.1.5.1. UNICAST	297
28.1.5.2. NAKACK	298
28.1.6. Group Membership (GMS)	298
28.1.7. Flow Control (FC)	299

28.2. FRAGMENTATION (FRAG2)	301
28.3. STATE TRANSFER	301
28.4. DISTRIBUTED GARBAGE COLLECTION (STABLE)	302
28.5. MERGING (MERGE2)	302
28.6. OTHER CONFIGURATION ISSUES	303
28.6.1. Binding JGroups Channels to a Particular Interface	303
28.6.2. Isolating JGroups Channels	304
28.6.2.1. Isolating Sets of JBoss Enterprise Application Platform Instances from Each Other	304
28.6.2.2. Isolating Channels for Different Services on the Same Set of JBoss Enterprise Application Platform Instances	304
28.6.2.2.1. Changing the Group Name	305
28.6.2.2.2. Changing the multicast address and port	305
28.6.2.2.3. Changing the Multicast Port	306
28.6.2.3. Improving UDP Performance by Configuring OS UDP Buffer Limits	306
28.6.3. JGroups Troubleshooting	307
28.6.3.1. Nodes do not form a cluster	307
28.6.3.2. Causes of missing heartbeats in FD	308
<b>CHAPTER 29. JBOSS CACHE CONFIGURATION AND DEPLOYMENT</b>	<b>309</b>
29.1. KEY JBOSS CACHE CONFIGURATION OPTIONS	309
29.1.1. Editing the CacheManager Configuration	309
29.1.2. Cache Mode	314
29.1.3. Transaction Handling	315
29.1.4. Concurrent Access	315
29.1.5. JGroups Integration	316
29.1.6. Eviction	317
29.1.7. Cache Loaders	317
29.1.7.1. CacheLoader Configuration for Web Session and SFSB Caches	318
29.1.8. Buddy Replication	319
29.2. DEPLOYING YOUR OWN JBOSS CACHE INSTANCE	320
29.2.1. Deployment Via the CacheManager Service	321
29.2.1.1. Accessing the CacheManager	321
29.2.2. Deployment Via a -service.xml File	323
29.2.3. Deployment Via a -jboss-beans.xml File	324
<b>PART IV. LEGACY EJB SUPPORT</b>	<b>327</b>
<b>CHAPTER 30. EJBS ON JBOSS</b>	<b>328</b>
The EJB Container Configuration and Architecture	328
30.1. THE EJB CLIENT SIDE VIEW	328
30.1.1. Specifying the EJB Proxy Configuration	331
30.2. THE EJB SERVER SIDE VIEW	335
30.2.1. Detached Invokers - The Transport Middlemen	335
30.2.2. The HA JRMPInvoker - Clustered RMI/JRMP Transport	339
30.2.3. The HA HttpInvoker - Clustered RMI/HTTP Transport	339
30.3. THE EJB CONTAINER	341
30.3.1. EJBDeployer MBean	341
30.3.1.1. Verifying EJB deployments	342
30.3.1.2. Deploying EJBS Into Containers	342
30.3.1.3. Container configuration information	343
30.3.1.3.1. The container-name element	347
30.3.1.3.2. The call-logging element	347
30.3.1.3.3. The invoker-proxy-binding-name element	347
30.3.1.3.4. The sync-on-commit-only element	347

30.3.1.3.5. insert-after-ejb-post-create	347
30.3.1.3.6. call-ejb-store-on-clean	347
30.3.1.3.7. The container-interceptors Element	347
30.3.1.3.8. The instance-pool element	348
30.3.1.3.9. The container-pool-conf element	348
30.3.1.3.10. The instance-cache element	348
30.3.1.3.11. The container-cache-conf element	349
30.3.1.3.12. The persistence-manager element	350
30.3.1.3.13. The web-class-loader Element	351
30.3.1.3.14. The locking-policy element	351
30.3.1.3.15. The commit-option and optiond-refresh-rate elements	351
30.3.1.3.16. The security-domain element	352
30.3.1.3.17. cluster-config	352
30.3.1.3.18. The depends element	353
30.3.2. Container Plug-in Framework	353
30.3.2.1. org.jboss.ejb.ContainerPlugin	354
30.3.2.2. org.jboss.ejb.Interceptor	354
30.3.2.3. org.jboss.ejb.InstancePool	355
30.3.2.4. org.jboss.ebj.InstanceCache	356
30.3.2.5. org.jboss.ejb.EntityPersistenceManager	357
30.3.2.6. The org.jboss.ejb.EntityPersistenceStore interface	361
30.3.2.7. org.jboss.ejb.StatefulSessionPersistenceManager	364
30.4. ENTITY BEAN LOCKING AND DEADLOCK DETECTION	365
30.4.1. Why JBoss Needs Locking	365
30.4.2. Entity Bean Lifecycle	365
30.4.3. Default Locking Behavior	366
30.4.4. Pluggable Interceptors and Locking Policy	366
30.4.5. Deadlock	367
30.4.5.1. Deadlock Detection	368
30.4.5.2. Catching ApplicationDeadlockException	368
30.4.5.3. Viewing Lock Information	369
30.4.6. Advanced Configurations and Optimizations	369
30.4.6.1. Short-lived Transactions	370
30.4.6.2. Ordered Access	370
30.4.6.3. Read-Only Beans	370
30.4.6.4. Explicitly Defining Read-Only Methods	370
30.4.6.5. Instance Per Transaction Policy	371
30.4.7. Running Within a Cluster	372
30.4.8. Troubleshooting	372
30.4.8.1. Locking Behavior Not Working	372
30.4.8.2. IllegalStateException	372
30.4.8.3. Hangs and Transaction Timeouts	372
30.5. EJB TIMER CONFIGURATION	372
<b>CHAPTER 31. THE CMP ENGINE .....</b>	<b>375</b>
31.1. EXAMPLE CODE	375
31.1.1. Enabling CMP Debug Logging	376
31.1.2. Running the examples	377
31.2. THE JBOSSCMP-JDBC STRUCTURE	378
31.3. ENTITY BEANS	379
31.3.1. Entity Mapping	382
31.4. CMP FIELDS	385
31.4.1. CMP Field Declaration	385

31.4.2. CMP Field Column Mapping	386
31.4.3. Read-only Fields	388
31.4.4. Auditing Entity Access	388
31.4.5. Dependent Value Classes (DVCs)	389
31.5. CONTAINER MANAGED RELATIONSHIPS	393
31.5.1. CMR-Field Abstract Accessors	394
31.5.2. Relationship Declaration	394
31.5.3. Relationship Mapping	395
31.5.3.1. Relationship Role Mapping	397
31.5.3.2. Foreign Key Mapping	399
31.5.3.3. Relation table Mapping	400
31.6. QUERIES	401
31.6.1. Finder and select Declaration	402
31.6.2. EJB-QL Declaration	402
31.6.3. Overriding the EJB-QL to SQL Mapping	403
31.6.4. JBossQL	404
31.6.5. DynamicQL	405
31.6.6. DeclaredSQL	406
31.6.6.1. Parameters	410
31.6.7. EJBQL 2.1 and SQL92 queries	410
31.6.8. BMP Custom Finders	411
31.7. OPTIMIZED LOADING	411
31.7.1. Loading Scenario	412
31.7.2. Load Groups	413
31.7.3. Read-ahead	414
31.7.3.1. on-find	414
31.7.3.1.1. Left join read ahead	415
31.7.3.1.2. D#findByPrimaryKey	416
31.7.3.1.3. D#findAll	416
31.7.3.1.4. A#findAll	417
31.7.3.1.5. A#findMeParentGrandParent	418
31.7.3.2. on-load	419
31.7.3.3. none	420
31.8. LOADING PROCESS	421
31.8.1. Commit Options	421
31.8.2. Eager-loading Process	422
31.8.3. Lazy loading Process	423
31.8.3.1. Relationships	424
31.8.4. Lazy loading result sets	427
31.9. TRANSACTIONS	427
31.10. OPTIMISTIC LOCKING	429
31.11. ENTITY COMMANDS AND PRIMARY KEY GENERATION	433
31.11.1. Existing Entity Commands	434
31.12. DEFAULTS	436
31.12.1. A sample jbosscmp-jdbc.xml defaults declaration	438
31.13. DATASOURCE CUSTOMIZATION	439
31.13.1. Type Mapping	439
31.13.2. Function Mapping	442
31.13.3. Mapping	442
31.13.4. User Type Mappings	443
<b>PART V. APPENDICES</b> .....	<b>445</b>

---

<b>APPENDIX A. SERVER DIRECTORY STRUCTURE</b> .....	<b>446</b>
A.1. SERVER PROFILE DIRECTORY STRUCTURE	447
A.1.1. The default Server Profile File Set	448
A.1.1.1. Contents of conf directory	449
A.1.1.2. Contents of deployers directory	450
A.1.1.3. Contents of deploy directory	451
A.1.2. The all Server Profile File Set	455
A.1.3. EJB3 Services	455
<b>APPENDIX B. VENDOR-SPECIFIC DATASOURCE DEFINITIONS</b> .....	<b>457</b>
B.1. DEPLOYER LOCATION AND NAMING	457
B.2. DB2	457
B.3. ORACLE	461
B.3.1. Changes in Oracle 10g JDBC Driver	464
B.3.2. Type Mapping for Oracle 10g	464
B.3.3. Retrieving the Underlying Oracle Connection Object	464
B.3.4. Limitations of Oracle 11g	464
B.4. SYBASE	465
B.4.1. Sybase Limitations	465
B.5. MICROSOFT SQL SERVER	466
B.5.1. Microsoft JDBC Drivers	468
B.5.2. JSQL Drivers	469
B.5.3. jTDS JDBC Driver	469
B.5.4. "Invalid object name 'JMS_SUBSCRIPTIONS' Exception	471
B.6. MYSQL DATASOURCE	472
B.6.1. Installing the Driver	472
B.6.2. MySQL Local-TX Datasource	472
B.6.3. MySQL Using a Named Pipe	473
B.7. POSTGRESQL	473
B.8. INGRES	475
<b>APPENDIX C. LOGGING INFORMATION AND RECIPES</b> .....	<b>476</b>
C.1. LOG LEVEL DESCRIPTIONS	476
C.2. SEPARATE LOG FILES PER APPLICATION	477
C.3. REDIRECTING CATEGORY OUTPUT	478
<b>APPENDIX D. REVISION HISTORY</b> .....	<b>479</b>





## PART I. OVERVIEW

## CHAPTER 1. SCOPE OF BOOK

The Administration and Configuration Guide explains how to administer and configure JBoss Enterprise Application Platform 5 components. It focuses both internal and implementation-specific details of JBoss Enterprise Application Platform.

This book is intended for JBoss administrators and developers, and attempts to provide the understanding needed to build, deploy, and debug JEE applications. It does not serve as an introduction to Java Enterprise Edition (JEE) or to creating JEE applications (refer to JEE specifications).

## CHAPTER 2. INTRODUCTION

JBoss Enterprise Application Platform 5 is an open-source JEE-based middleware solution. It is built on top of the consolidated JBoss Application Server 5 called JBoss Enterprise Application Server, which introduces the new JBoss Microcontainer.

The JBoss Microcontainer is a lightweight container that supports direct deployment, configuration, and lifecycle of plain old Java objects (POJOs). It replaces the JBoss JMX Microkernel used in the 4.x JBoss Enterprise Application Platforms.

JBoss Enterprise Application Platform also includes the following supported components:

- JBoss HTTP Connector for load balancing
- PicketLink framework for identity management
- RESTEasy framework for RESTful web services
- Seam framework for development

The JBoss Microcontainer integrates with the JBoss Aspect Oriented Programming framework (JBoss AOP, refer to [Chapter 12, JBoss AOP](#)). Support for JMX in JBoss Enterprise Application Platform 5 remains strong and MBean services written against the old Microkernel are expected to work.

### 2.1. INTEGRATED PROJECTS

JBoss Enterprise Application Platform 5 integrates the following standalone JBoss projects:

#### JBoss EJB

JBoss EJB3 provides the implementation of the Enterprise Java Beans (EJB) specification. EJB 3.0 is a deep overhaul and simplification of the EJB specification.

#### JBoss Transactions

JBoss Transactions is the default transaction manager compliant with JTA, JTS and Web Services standards.

#### JBoss Web

JBoss Web is the Web container component based on Apache Tomcat that includes the Apache Portable Runtime (APR) and Tomcat native technologies.

#### JBoss Messaging (JMS)

JBoss Messaging is the default messaging provider. It is also the backbone of the JBoss enterprise service bus (ESB) infrastructure. JBoss Messaging substitutes JBossMQ, which is the default JMS provider for JBoss Enterprise Application Platform 4.2.

#### JBoss Cache

JBoss Cache provides two types of transactional cache: a traditional tree-structured node-based cache; and a PojoCache, an in-memory, transactional, and replicated cache system that allows users to operate on simple POJOs transparently without active user management of either replication or persistency aspects.



## IMPORTANT

JBoss Cache is deprecated and substituted by Infinispan in the next major JBoss Enterprise Application Platform release.

### JBossWS 3.x

JBossWS 3.x is the web service stack that provides Java EE compatible web services.

## 2.2. ARCHITECTURE

JBoss Enterprise Application Platform is a JBoss product based on the JBoss Enterprise Application Server with the following additional components:

- JBoss HTTP Connector for load balancing
- Picketlink framework for identity management
- RESTEasy framework for RESTful web services
- Seam framework for development of web application

The heart of JBoss Enterprise Application Platform is the JBoss Enterprise Application Server, which is a consolidated JBoss Application Server. [Figure 2.1, “Components”](#) contains a schema of the JBoss Enterprise Application Server and its components. The entire JBoss Enterprise Application Server rests on a JVM (Java Virtual Machine) to allow the execution of the Java code.

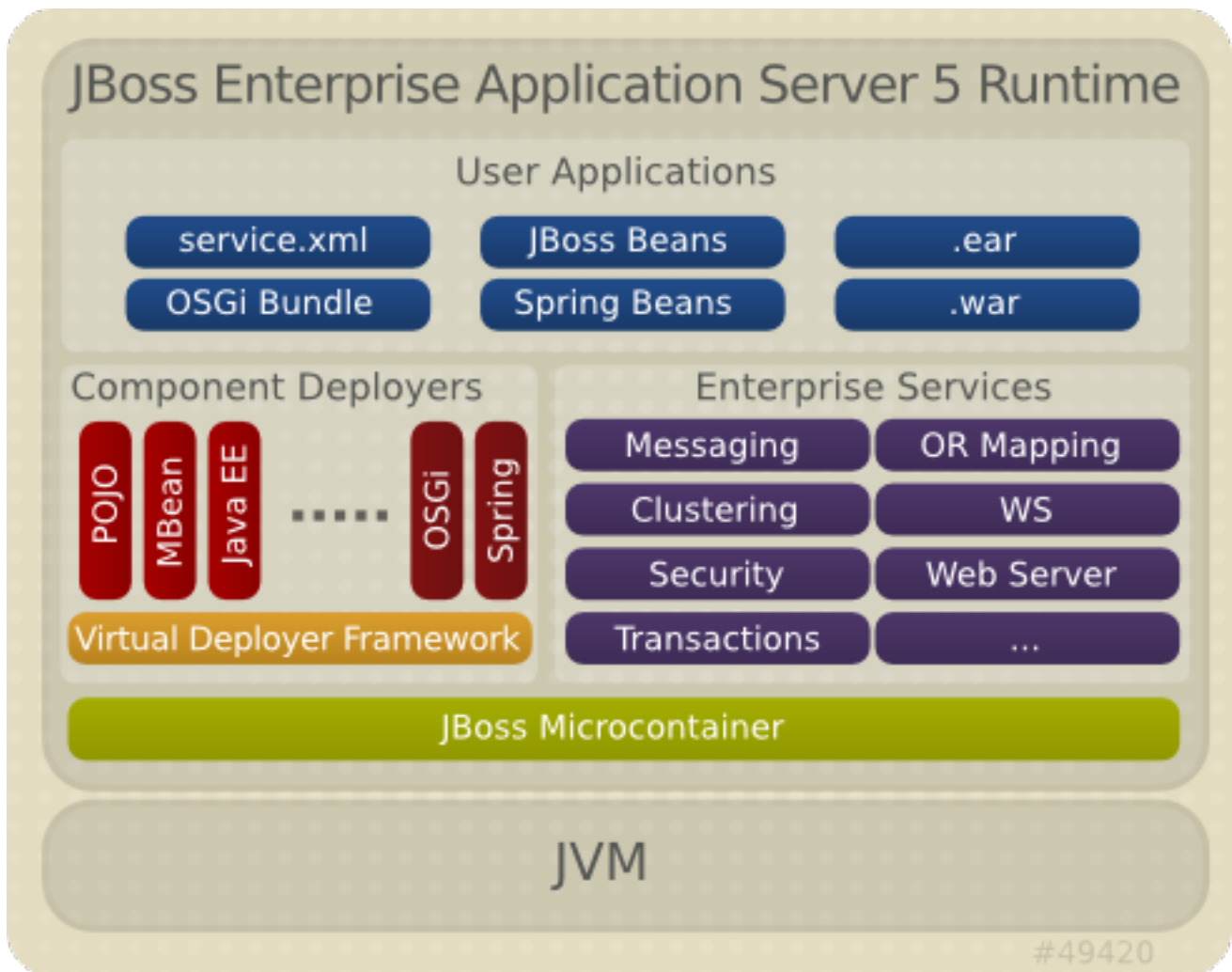

Figure 2.1. Components

### JBoss Microcontainer kernel

is the execution core of JBoss Enterprise Application Platform. It loads the bootstrap beans so as to connect to the deployed services. JBoss Microcontainer substitutes JMX (Java Management Extension). However, MCBans and legacy MBean deployments are still included so as to support legacy services.

### Component Deployers

cover the loading of the deployed resources.

### Enterprise Services

include all services of the JBoss Enterprise Application Platform.

## 2.3. DIRECTORY STRUCTURE

The directory structure resembles the architecture of the 4.x series with minor differences. Note that JBoss Enterprise Application Platform now contains the HTTP Connector (in the `mod_cluster` directory), Picketlink (in the `picketlink` directory), and RESTeasy (in the `resteasy` directory).

The JBoss Enterprise Application Server directory now contains the `common` directory, which has been added to accommodate the libraries common for all server profiles and prevent the library duplication in the directory structure.

The JBoss Enterprise Application Platform basic directory structure is as follows:

- **jboss-as** – JBoss Enterprise Application Server home directory
  - **bin** – start and shutdown scripts, other useful scripts
  - **client** – client JAR files
  - **common** – static JAR files shared by all server profiles
- **mod\_cluster** – JBoss HTTP Connector
- **picketlink** – the PicketLink project
- **resteasy** – RESTEasy implementation (JSR-311, JAX-RS)
- **seam** – JBoss Seam application framework home directory

This directory has been added to prevent duplicated copying of common libraries into individual server profile directories.

- **docs** – schemas/dtds, examples
- **lib** – core bootstrap JAR files
  - **endorsed** – directory on the server JVM `java.endorsed.dirs` path
- **server** – server profile directories

Note that JBoss Enterprise Application Platform 4.3 contained two seam directories: **seam1** and **seam2**. The **seam1** directory contained Seam 1.2.1 that was delivered originally with JBoss Enterprise Application Platform 4. It contained the **drools**, **embedded-ejb**, and **hibernate** directories with libraries. Now, these are in the **lib** directory. Also, the mail resource adapter has been moved for the **mail** directory to **extras** and **buni-meldware**, external mail and groupware server intended for presentation purposes, has been removed.

The **seam2** directory contained the 2.0.2FP version of the Seam delivered with JBoss Enterprise Application Platform Feature Pack and the structure has not undergone any significant changes.

- **bootstrap** – JBoss Embedded configuration for the Seam integration testsuite (refer to the S
- **lib** – library directory
- **seam-gen** – command-line utility for generating simple skeletal Seam project to allow a quick project start
- **build** – configuration and resources for building
- **examples** – examples demonstrating uses of Seam's features
- **extras** – mail resource adapter; JsUnit testing
- **ui** – sources for the Seam UI module

Refer to [Section 7.2, “Standard Server Profiles”](#) for details of the server profiles included in this release. Also refer to [Appendix A, \*Server Directory Structure\*](#).

## 2.4. JBOSS ENTERPRISE APPLICATION PLATFORM USE CASES

JBoss Enterprise Application Platform is typically used for the following web application types and scenarios:

- Most web applications involving a database
- Web applications likely to be clustered
- Simple web applications with JSPs/Servlets upgrades to JBoss Enterprise Application Platform with Tomcat Embedded
- Intermediate web applications with JSPs/Servlets using a web framework such as Struts, Java Server Faces, Cocoon, Tapestry, Spring, Espresso, Avalon, Turbine
- Complex web applications with JSPs/Servlets, Seam, Enterprise Java Beans (EJB), Java Messaging (JMS), caching etc.
- Cross-application middleware (JMS, Corba, JMX, etc.)



### NOTE

This distribution comes with multiple sample applications including the Seam Booking Application located in `$EAP_HOME/seam/examples/booking/`. The application is a Java EE 5 application that makes use of the following technologies:

- EJB3
- Stateful Session Beans
- Stateless Session Beans
- JPA (w/ Hibernate validation)
- JSF
- Facelets
- Ajax4JSF
- Seam

## 2.5. BOOTSTRAP

The JBoss Enterprise Application Platform 5 bootstrap is similar to the bootstrap in JBoss Enterprise Application Platform 4 in that the `org.jboss.Main` entry point loads an `org.jboss.system.server.Server` implementation. In JBoss Enterprise Application Platform 4 this was a JMX-based microkernel. In JBoss Enterprise Application Platform 5, this is a JBoss Microcontainer.

The default JBoss Enterprise Application Platform 5 `org.jboss.system.server.Server` implementation is `org.jboss.bootstrap.microcontainer.ServerImpl`. This implementation is

an extension of the kernel basic bootstrap that boots the MC from the bootstrap beans declared in `{jboss.server.config.url}/bootstrap.xml` descriptors using a `BasicXMLDeployer`. In addition, the `ServerImpl` registers install callbacks for any beans that implement the `org.jboss.bootstrap.spi.Bootstrap` interface. The `bootstrap/profile*.xml` configurations include a `ProfileServiceBootstrap` bean that implements the `Bootstrap` interface.

The `org.jboss.system.server.profileservice.ProfileServiceBootstrap` is an implementation of the `org.jboss.bootstrap.spi.Bootstrap` interface that loads the deployments associated with the current server profile. The `<PROFILE>` is the name of the server profile being loaded and corresponds to the `server -c` command line argument. The default `<PROFILE>` is `default`.

## 2.6. HOT DEPLOYMENT

Hot deployment in JBoss Enterprise Application Platform 5 is controlled by the `Profile` implementations associated with the `ProfileService`. The `HDScanner` bean deployed via the `deploy/hdscanner-jboss-beans.xml` MC deployment, queries the profile service for changes in application directory contents and redeploys updated content, undeploys removed content, and adds new deployment content to the current server profile via the `ProfileService`.

If you want to disable hot deployment, temporarily or permanently, use either of the following methods. The second method is best used if you are disabling hot deployment only temporarily, since it's the easiest to undo.

- Remove the `hdscanner-jboss-beans.xml` file from deployment;
- Edit the `hdscanner-jboss-beans.xml` file, add the `scanEnabled` attribute (if it's not already present) and set its value to `false`.

Below is an extract of a `hdscanner-jboss-beans.xml` file in which hot deployment has been disabled.

```
<?xml version="1.0" encoding="UTF-8"?>
<!--
  Hot deployment scanning

  $Id: hdscanner-jboss-beans.xml 98983 2010-01-04 13:35:41Z emuckenhuber
  $
-->
<deployment xmlns="urn:jboss:bean-deployer:2.0">

  <!-- Hotdeployment of applications -->
  <bean name="HDScanner"
class="org.jboss.system.server.profileservice.hotdeploy.HDScanner">
    <property name="deployer"><inject
bean="ProfileServiceDeployer"/></property>
    <property name="profileService"><inject
bean="ProfileService"/></property>
    <property name="scanPeriod">5000</property>
    <property name="scanThreadName">HDScanner</property>
    <property name="scanEnabled">>false</property>
  </bean>
```



```
...(snip)...
```

```
</deployment>
```

### 2.6.1. Adding a Custom Deploy Folder

JBoss Enterprise Application Platform, by default, looks for deployments under the `<JBOSS_HOME>/jboss-as/server/<PROFILE>/deploy` folder. However you can configure the server to even include your custom folder for scanning deployments. This can be done by configuring the `BootstrapProfileFactory` MC bean in `<JBOSS_HOME>/jboss-as/server/<PROFILE>/conf/bootstrap/profile.xml` file. The `applicationURIs` property of the `BootstrapProfileFactory` accepts a list of URLs which will be scanned for applications. You can add your custom deploy folder to this list. For example, if you want `/home/me/myapps` to be scanned for deployments, then you can add the following:

```
<bean name="BootstrapProfileFactory"
class="org.jboss.system.server.profileservice.repository.
StaticProfileFactory">
...
  <property name="applicationURIs">
    <list elementClass="java.net.URI">
      <value>${jboss.server.home.url}deploy</value>
      <value>file:///home/me/myapps</value>
    </list>
  </property>
...

```



#### IMPORTANT

Modifying the `<JBOSS_HOME>/jboss-as/server/<PROFILE>/conf/bootstrap/profile.xml` requires a server restart, for the changes to take effect.

For performance reasons, adding a new deployment folder to the `BootstrapProfileFactory` also requires the same URL to be added to the `VFSCache` MC bean configuration in `<JBOSS_HOME>/jboss-as/server/<PROFILE>/conf/bootstrap/vfs.xml`. For example:

```
<bean name="VFSCache">
...
  <property name="permanentRoots">
    <map keyClass="java.net.URL"
valueClass="org.jboss.virtual.spi.ExceptionHandler">
      ...
      <entry>
        <key>file:///home/me/myapps</key>
        <value><inject bean="VfsNamesExceptionHandler"/></value>
      </entry>
    </map>
  </property>
...

```

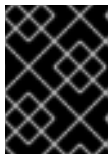

## IMPORTANT

Not adding the custom deployment folder to **VFSCache** might result in growing disk space usage by the server, over a period of time.

## **PART II. JBOSS ENTERPRISE APPLICATION PLATFORM CONFIGURATION**

## CHAPTER 3. NETWORK

### 3.1. IPV6 SUPPORT

JBoss Enterprise Application Platform 5 does not include support for IPv6, although this support is planned for the future.

## CHAPTER 4. JBOSS WEB

The most common technologies for creating Java web applications are JSPs and servlets, the standard Java EE web component technologies. To allow deployment of JSPs and servlets, JBoss comes with the JBoss Web container. JBoss Web represents the web tier of JBoss Enterprise Application Platform, and provides the servlet container and HTTP web server based on Apache Tomcat for the deployment of JSPs and servlets.

JBoss Web supports the Apache Portable Runtime (APR) library, which allows use of native connectors such as `mod_jk`, `mod_cluster`, and `mod_proxy`.

### 4.1. SYSTEM PROPERTIES

The following system properties modify the JBoss Web server behavior:

#### General Properties

##### `catalina.useNaming`

override for the `useNaming` element of the `Context` element

Set to `false` to override the `useNaming` attribute of all `Context` elements.

##### `catalina.config`

URL of the `catalina.properties` configuration file

##### `jvmRoute`

used if an `Engine` element does not define its `jvmRoute` attribute

##### `org.apache.catalina.loader.WebappClassLoader.ENABLE_CLEAR_REFERENCES`

activation or deactivation of clearing static or final fields from loaded classes (set to `true` by default)

Set to `true` to null out static or final fields from the loaded classes when a web application is stopped. This setting provides a workaround for garbage collection bugs and application coding errors.

##### `org.apache.tomcat.util.buf.StringCache.byte.enabled`

enabling the String cache for `ByteChunk` (set to `false` by default)

Set to `true` to enable the String cache for `ByteChunk`.

##### `org.apache.tomcat.util.buf.StringCache.char.enabled`

enabling the String cache for `CharChunk` (set to `false` by default)

Set to `true` to enable the String cache for `CharChunk`.

##### `org.apache.tomcat.util.buf.StringCache.trainThreshold`

call limit for the String cache activation (set to `2000` by default)

The limit defines the number of times the `toString()` method must be called before the String cache is activated.

**`org.apache.tomcat.util.buf.StringCache.cacheSize`**

size of the String cache (set to 200 entries by default)

**`org.apache.tomcat.util.buf.StringCache.maxStringSize`**

maximum length of a cached String (set to 128 characters by default)

**`org.apache.tomcat.util.http.FastDateFormat.CACHE_SIZE`**

size of the cache used for parsing and formatting of date values (2000 entries by default)

**`org.apache.catalina.core.StandardService.DELAY_CONNECTOR_STARTUP`**

disabling automatic connector start-up (To prevent the connector from starting up automatically, set to `true`.)

**`org.apache.catalina.connector.Request.SESSION_ID_CHECK`**

enabling session verification (If enabled, that is set to `true`, the Servlet container verifies if a session with the specified session ID exists in a context before creating a session with that ID.)

**`org.apache.coyote.USE_CUSTOM_STATUS_MSG_IN_HEADER`**

enabling custom HTTP status messages in HTTP headers (If enabled, that is set to `true`, custom HTTP status messages are allowed in HTTP headers.)



**IMPORTANT**

Ensure that any such message uses only the ISO-8859-1 characters to prevent a possible XSS vulnerability. The property is set to `false` by default.

**`org.apache.tomcat.util.http.ServerCookie.VERSION_SWITCH`**

activates automatic usage of v1 cookies (set to `true` by default)

The v1 cookies are used automatically if the servlet container is using v0 cookies and cookie values which have to be quoted to be valid.

**`org.apache.el.parser.COERCE_TO_ZERO`**

sets if "" and null numbers become 0

This is the desired behavior defined in the specification and therefore the property is set to `true` by default.

## JSP Configuration Properties

**`org.apache.jasper.compiler.Generator.VAR_EXPRESSIONFACTORY`**

the variable used as the expression language expression factory (if unspecified the `_el_expressionfactory` is used)

**org.apache.jasper.compiler.Generator.VAR\_INSTANCEMANAGER**

The name of the variable to use for the instance manager factory. If not specified, the default value of `_jsp_instancemanager` will be used.

**org.apache.jasper.compiler.Parser.STRICT\_QUOTE\_ESCAPING**

If false the requirements for escaping quotes in JSP attributes will be relaxed so that a missing required quote will not cause an error. If not specified, the specification compliant default of true will be used.

**org.apache.jasper.runtime.JspFactoryImpl.USE\_POOL**

If true, a ThreadLocal PageContext pool will be used. If not specified, the default value of true will be used.

**org.apache.jasper.runtime.JspFactoryImpl.POOL\_SIZE**

The size of the ThreadLocal PageContext. If not specified, the default value of 8 will be used.

**org.apache.jasper.Constants.JSP\_SERVLET\_BASE**

The base class of the Servlets generated from the JSPs. If not specified, the default value of `org.apache.jasper.runtime.HttpJspBase` will be used.

**org.apache.jasper.Constants.SERVICE\_METHOD\_NAME**

The name of the service method called by the base class. If not specified, the default value of `_jspService` will be used.

**org.apache.jasper.Constants.SERVLET\_CLASSPATH**

The name of the ServletContext attribute that provides the classpath for the JSP. If not specified, the default value of `org.apache.catalina.jsp_classpath` will be used.

**org.apache.jasper.Constants.JSP\_FILE**

The name of the request attribute for `<jsp-file>` element of a servlet definition. If present on a request, this overrides the value returned by `request.getServletPath()` to select the JSP page to be executed. If not specified, the default value of `org.apache.catalina.jsp_file` will be used.

**org.apache.jasper.Constants.PRECOMPILE**

The name of the query parameter that causes the JSP engine to just pre-generate the servlet but not invoke it. If not specified, the default value of `org.apache.catalina.jsp_precompile` will be used.

**org.apache.jasper.Constants.JSP\_PACKAGE\_NAME**

The default package name for compiled jsp pages. If not specified, the default value of `org.apache.jsp` will be used.

**org.apache.jasper.Constants.TAG\_FILE\_PACKAGE\_NAME**

The default package name for tag handlers generated from tag files. If not specified, the default value of `org.apache.jsp.tag` will be used.

**org.apache.jasper.Constants.ALT\_DD\_ATTR**

The servlet context attribute under which the alternate deployment descriptor for this web application is stored. If not specified, the default value of `org.apache.catalina.deploy.alt_dd` will be used.

**org.apache.jasper.Constants.TEMP\_VARIABLE\_NAME\_PREFIX**

Prefix to use for generated temporary variable names. If not specified, the default value of `_jspx_temp` will be used.

**org.apache.jasper.Constants.USE\_INSTANCE\_MANAGER\_FOR\_TAGS**

If true, the instance manager is used to obtain tag handler instances. If not specified, false will be used.

**org.apache.jasper.Constants.USE\_INSTANCE\_MANAGER\_FOR\_TAGS**

If true, annotations specified in tags will be processed and injected. This can have a performance impact when using simple tags, or if tag pooling is disabled. If not specified, true will be used.

**Security Configuration Properties****org.apache.catalina.connector.RECYCLE\_FACADES**

If this is true or if a security manager is in use a new facade object will be created for each request. If not specified, the default value of false will be used.

**org.apache.catalina.connector.CoyoteAdapter.ALLOW\_BACKSLASH**

If this is true the `\` character will be permitted as a path delimiter. If not specified, the default value of false will be used.

**org.apache.tomcat.util.buf.UDecoder.ALLOW\_ENCODED\_SLASH**

If this is true `'%2F'` and `'%5C'` will be permitted as path delimiters. If not specified, the default value of false will be used.

**Properties Required by Specification****org.apache.catalina.STRICT\_SERVLET\_COMPLIANCE**

If set to `true`, then the following applies:

- any wrapped request or response object passed to an application dispatcher is checked to ensure that it has wrapped the original request or response. (SRV.8.2 / SRV.14.2.5.1)
- a call to `Response.getWriter()` if no character encoding has been specified will result in subsequent calls to `Response.getCharacterEncoding()` returning ISO-8859-1 and the Content-Type response header will include a `charset=ISO-8859-1` component. (SRV.15.2.22.1)
- every request that is associated with a session will cause the session's last accessed time to be updated regardless of whether or not the request explicitly accesses the session. (SRV.7.6)

**org.apache.catalina.core.StandardWrapperValve.SERVLET\_STATS**

If true or if `org.apache.catalina.STRICT_SERVLET_COMPLIANCE` is true, the wrapper will collect the JSR-77 statistics for individual servlets. If not specified, the default value of false will be used.

**org.apache.catalina.session.StandardSession.ACTIVITY\_CHECK**

If this is true or if `org.apache.catalina.STRICT_SERVLET_COMPLIANCE` is true Tomcat will track the



number of active requests for each session. When determining if a session is valid, any session with at least one active request will always be considered valid. If not specified, the default value of false will be used.

### 4.1.1. Modifying System Properties

You can modify the system properties either in the `JBOSS_HOME/bin/run.conf` or in the form of a `-D` option on server start-up (refer to the Getting Started Guide).

## 4.2. CONFIGURING THE JBOSS WEB CONTAINER

The JBoss Web container configuration defines how the container handles the execution and deployment of web application. The configuration is loaded and applied on the server startup; therefore, changes made to the configuration are not applied to the running server.

The JBoss Web behavior can be configured using Tag Library Descriptor (TLD) configuration files:

#### `server.xml`

The `server.xml` is the main JBoss Web server configuration file (for further details refer to [Section 4.3, “The Main Config File”](#) )

#### `web.xml`

The `web.xml` file is a deployment descriptor defining URL mappings to servlets (defines how web applications are executed)

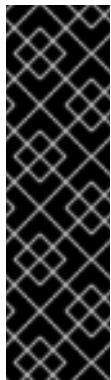

### IMPORTANT

There are two types of `web.xml`: the global `web.xml` valid for the entire server and the local `web.xml` valid for a web application. The local file overrides the global `server.xml` file for the given web application.

The global `web.xml` file is located in `$JBOSS_SERVER_HOME/deployers/jbossweb.deployer/` directory, while the web-application specific file is located in the `WEB-INF/` directory of the web application.

## 4.3. THE MAIN CONFIG FILE

The main JBoss Web server configuration file is the TLD `server.xml` file located in the `$JBOSS_SERVER_HOME/PROFILE/deploy/jbossweb.sar/` directory. The file defines the JBoss Web server configuration with a set of XML configuration elements and their attributes.

The elements must follow the nesting depicted in [Figure 4.1, “The server.xml file schema”](#).

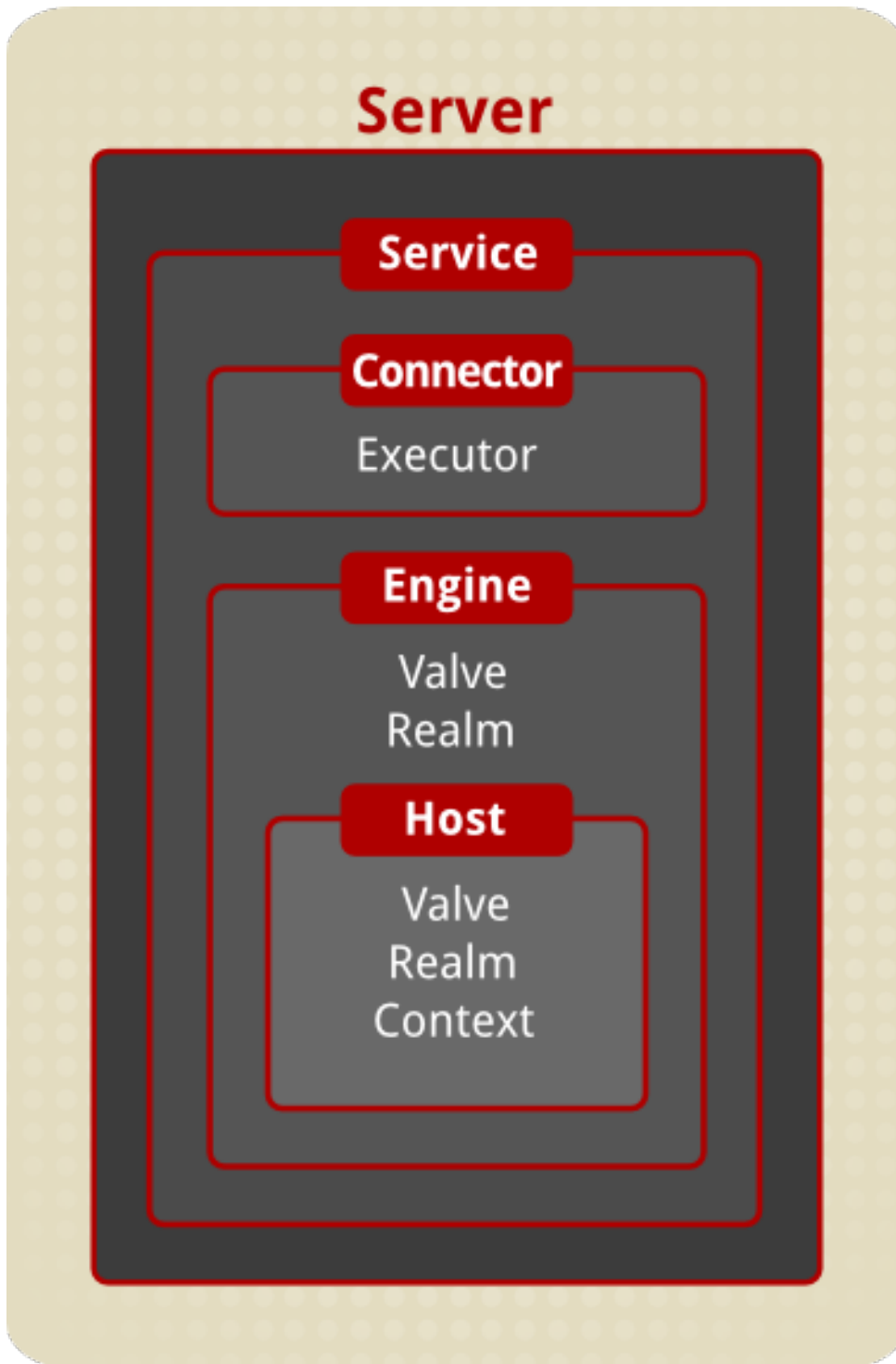

Figure 4.1. The `server.xml` file schema

The elements can be divided in the following categories:

- top-level elements: contain any other elements (`<Server>` and `<Service>`);
- connectors: represent interface between clients and the service that receives the clients' requests;
- containers: represent components, which process incoming requests (`<Engine>`, `<Host>`, and `<Context>`);
- nested components: represent entities that provide further functionalities to their parent elements or intercept the request processing;

## 4.4. TOP-LEVEL ELEMENTS

The TLD `server.xml` file contains the `<Server>` top-element, which contains the `<Service>` elements. Any other elements are nested in these two elements.

### 4.4.1. Server

The `Server` is a container element that represents the entire servlet container and is the only parent of any other element, that is, it is the only top-level element.

It can contain multiple `Service`, `GlobalNamingResources` and `Listener` elements.



#### NOTE

The `Server` element in the JBoss Web's `server.xml` file contains multiple `Listener` elements. Amongst others, the `org.apache.catalina.core.AprLifecycleListener` and the `org.apache.catalina.core.JasperListener`. If the `mod_cluster` load balancer is enabled for the profile, also the `org.jboss.web.tomcat.service.deployers.MicrocontainerIntegrationLifecycleListener` is required.

The `AprLifecycleListener` and the `JasperListener` are used to start up and shut down APR and initialize Jasper. Removing the `Listener` elements is therefore discouraged just as removing the `MicrocontainerIntegrationLifecycleListener`.

Table 4.1. Server Element Attributes

Attribute	Description
<code>className</code>	class implementing the <code>Server</code>  The defined class must implement the <code>org.apache.catalina.Server</code> interface. If no class is specified, the standard implementation is used, that is, <code>org.apache.catalina.core.StandardServer</code> .
<code>port</code>	TCP/IP port number on which the server expects the shutdown command  <b>The connection must be initiated from the server computer that runs the JBoss Web server instance.</b>
<code>shutdown</code>	string that the server must receive on the port specified in the <code>port</code> property to shutdown

### 4.4.2. Service

The `Service` element serves as a container for `Connectors` that share a single `Engine` component. There can be multiple `Service` components in one `Server` element and the `Service` component can contain multiple `Connector` elements followed by exactly one `Engine` element.

Table 4.2. Service Element Attributes

Attribute	Description
className	<p>class implementing the Service</p> <p>The class must implement the <code>org.apache.catalina.Service</code> interface. If no className is specified, the standard <code>org.apache.catalina.core.StandardService</code> implementation is used.</p>
name	Service name unique within the <b>Server</b> element (the name is used for log purposes)

## 4.5. CONNECTOR

The **Connector** element represents an interface between clients and the Service; the element defines how client requests are transported.

There are multiple optional connectors available with JBoss Web: JK2 (`mod_jk`), `mod_cluster`. By default, the connector for HTTP and for AJP are defined.



### NOTE

Further details about configuration of individual connectors are available in the HTTP Connectors Load Balancing Guide on the [Red Hat Documentation website](#).

### 4.5.1. Executor

The **Executor** represents a thread pool that can be shared among components (primarily among connectors).

Every Executor must implement the `org.apache.catalina.Executor` interface.

**Table 4.3. Element Attributes**

Attribute	Description
className	<p>class implementing the Executor</p> <p>The class must implement the <code>org.apache.catalina.Executor</code> interface. If no className is specified, the standard <code>org.apache.catalina.core.StandardThreadExecutor</code> implementation is used.</p>
name	Executor name (the name must be unique within the <b>Server</b> element)

**Table 4.4. Additional Element Attributes of the Standard Executor Implementation (`org.apache.catalina.core.StandardThreadExecutor`)**

Attribute	Description
-----------	-------------

Attribute	Description
threadPriority	thread priority for threads in the executor ( <code>Thread.NORM_PRIORITY</code> by default)
daemon	enabling/disabling daemon threads ( <code>true</code> by default)
namePrefix	name prefix for each thread created by the executor (the thread name takes the form <code>namePrefix+threadNumber</code> )
maxThreads	maximum number of active threads in the thread pool ( <b>200</b> by default)
minSpareThreads	minimum number of threads kept alive ( <b>25</b> by default)
maxIdleTime	number of milliseconds before the idle thread is shut down (applied only if the number of active threads is higher than the <code>minSpareThreads</code> value; <b>60.000</b> by default)

## Defining Executor for Multiple Components

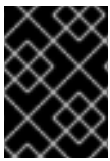

### IMPORTANT

Previously, it was possible to define the Executor for a single Connector in the `server.xml` file. Such Executor definitions are now ignored.

To define an Executor, do the following:

1. Open the `$JBOSS_SERVER_HOME/PROFILE/deploy/jbossweb.sar/META-INF/jboss-beans.xml` file.
2. Add the Executor bean definition to the file (see [Example 4.1, “Executor bean definition”](#)).

#### Example 4.1. Executor bean definition

```
<bean name="Executor"
class="org.apache.catalina.core.StandardThreadExecutor">
<property name="maxThreads">300</property>
<property name="minSpareThreads">25</property>
</bean>
```

3. Set the `executor` property for the `TomcatService` bean.

```
<bean name="WebServer"
class="org.jboss.web.tomcat.service.deployers.TomcatService">

<annotation>@org.jboss.aop.microcontainer.aspects.jmx.JMX(name="jboss.web:service=WebServer",
exposedInterface=org.jboss.web.tomcat.service.deployers.TomcatServiceMBean.class,registerDirectly=true)</annotation>
```

```

:
<!--This is the executor property you need to add.-->
<property name="executor"><inject bean="Executor"/></property>
</bean>

```

## 4.6. CONTAINERS

Containers represent components, which process incoming requests (<Engine>, <Host>, and <Context>).

### 4.6.1. Engine

The Engine represents the entity that processes the requests received by the parent Service; that is, the engine accepts requests from all Connectors defined for the Service, processes them, and returns them to the appropriate Connector.

To define the virtual host of the server that the engine can use, nest multiple **Host** elements inside the Engine element; each **Host** element represents one virtual host. You need to define at least one **Host** element and one of the Hosts *must* have a name that matches the `defaultHost` value defined in the parent Engine element.

The **Engine** element can contain at most one **Realm** element. The **Realm** element represents a database of users and their roles: the user information defined in the respective resource is shared across all Hosts and Contexts nested inside the Engine. Realm setting in the Engine element can be overridden by another **Realm** element defined in a lower-level element; that is, a Host or Context element.

**Table 4.5. Engine Element Attributes**

Attribute	Description
<code>backgroundProcessorDelay</code>	<p>delay between the invocation of the <b>backgroundProcess</b> method on the engine and the invocation of the <b>backgroundProcess</b> method on the child containers of the Engine (Engine's Hosts and Contexts; <b>10</b> by default, that is 10 seconds)</p> <p>If set to a positive value, the engine produces a thread. The thread waits for the specified amount of time and then invokes the <b>backgroundProcess</b> method on the engine and all its child containers.</p> <p>Host and Context containers can also define the <code>backgroundProcessorDelay</code> attribute. If the delay of a child container is not negative, the child container is using its own processing thread.</p>
<code>className</code>	<p>class implementing the Engine</p> <p>The class must implement the <code>org.apache.catalina.Engine</code> interface. If not specified, the standard value <b><code>org.apache.catalina.core.StandardEngine</code></b> is used.</p>

Attribute	Description
defaultHost	<p>name of the default host name</p> <p>The default Host processes requests directed to host names on the server that are not configured in the <code>server.xml</code> configuration file. The defaultHost must match the name attribute of a Host element nested immediately inside the Engine element.</p>
jvmRoute	<p>identifier used in load balancing scenarios to enable session affinity (so-called "sticky sessions")</p> <p>The identifier must be unique across all JBoss Web servers which participate in the cluster. It is appended to the generated session identifier so that a front-end proxy can always forward a particular session to the same JBoss Web instance.</p>
name	<p>logical name of the Engine used in log and error messages</p> <p>When using multiple Service elements in the same Server, each Engine <i>must</i> be assigned a unique name.</p>

**NOTE**

Make sure the Engine element is located *after* all its connectors as connectors defined after the Engine element are ignored.

**4.6.2. Host**

The **Host** element represents a virtual host on the Engine. It allows you to associate a network name with the server, that is, to change the domains or the hostname of the Server.

**NOTE**

The network name needs to be registered in the Domain Name Service (DNS) server that manages your Internet domain (contact your Network Administrator for more information).

One **Engine** can contain multiple virtual hosts, that is the Engine element can have several **Host** elements nested. The Host element can contain **Context** elements for individual web applications associated with the virtual host. Exactly one of the Hosts in every Engine *must* have a name matching the defaultHost attribute of the Engine.

A **Host** element can contain multiple **Alias** elements to allow the virtual host to use multiple hostnames (refer to [Section 4.6.2.1, “Defining Host Name Aliases”](#)).

The **Host** element can contain at most one **Realm** element. A **Realm** element in a Host represents a database of users and their roles used by the virtual host. If the **Realm** element is nested in the **Host** element, the user information is shared across all Contexts nested inside the Host unless overridden by another **Realm** element defined for a child **Context** element.

**Table 4.6. Host Element Attributes**

Attribute	Description
appBase	<p>Application Base directory for the virtual host</p> <p>The Application Base directory is the pathname of a directory that contains web applications to be deployed on the virtual host. The property value can be defined as an absolute path to the directory or a path relative to the <code>\$JBOSS_SERVER_HOME</code> directory.</p>
autoDeploy	<p>automatic deployment of web applications dropped in the Application Base directory while the JBoss Web server is running (<b>true</b> by default)</p> <div style="display: flex; align-items: flex-start;">  <div> <p><b>NOTE</b></p> <p>Note that the default deployment directory is <code>\$JBOSS_SERVER_HOME/server/\$PROFILE/deploy/</code> directory.</p> </div> </div>
backgroundProcessorDelay	<p>delay between the invocation of the <b>backgroundProcess</b> method on the host and the invocation of the <b>backgroundProcess</b> method on the child containers of the Host (such as Contexts; set to <b>-1</b> by default, that is the Host uses the background processing thread of its Engine)</p> <p>If set to a positive value, the Host produces a thread. The thread waits for the specified amount of time and then invokes the <b>backgroundProcess</b> method on the virtual host and all its child containers.</p> <p>Context containers can also define the <code>backgroundProcessorDelay</code> attribute. If the delay of a child Context is not negative, the Context uses its own processing thread.</p>
className	<p>class implementing the Host</p> <p>The defined class must implement the <code>org.apache.catalina.Host</code> interface. If no class is specified, the standard implementation is used, that is, <code>org.apache.catalina.core.StandardHost</code>.</p>
deployOnStartup	<p>automatic deployment of web applications from the Host (<b>true</b> by default)</p>
name	<p>network name of the virtual host as registered in your Domain Name Service server</p> <p>One of the Hosts nested in the Engine <i>must</i> have a name that matches the <code>defaultHost</code> setting for the parent Engine.</p>

**Table 4.7. Additional Element Attributes of the Standard Host Element Implementation (`org.apache.catalina.core.StandardHost`)**

Attribute	Description
-----------	-------------



Attribute	Description
deployXML	<p>applying the <code>context.xml</code> file located inside the web application (that is, <code>/META-INF/context.xml</code>; <code>true</code> by default)</p> <p>If set to <code>false</code> to parsing of the <code>context.xml</code> file is disabled. In security conscious environments, set to <code>false</code> to prevent applications from interacting with the container's configuration and provide an external context configuration file to the <code>\$JBOSS_SERVER_HOME/conf/enginename/hostname/</code> directory.</p>
errorReportValveClass	<p>class implementing the error reporting valve used by the Host</p> <p>The defined class must implement the <code>org.apache.catalina.Valve</code> interface. If no class is specified, the <code>org.apache.catalina.valves.ErrorReportValve</code> implementation is used.</p> <p>The valve defines the output error reports. This property allows you to customize the look of the error pages generated by JBoss Web.</p>
unpackWARs	<p>automatic unpacking of deployer WAR files (<code>false</code> by default)</p> <p>If set to <code>true</code>, web applications that are placed in the <code>appBase</code> directory in the form of a web application archive (WAR) file are unpacked into a corresponding disk directory structure. If set to <code>false</code>, such a web application is run from the WAR file.</p>
workDir	<p>pathname to a scratch directory used by applications on the Host (if not specified, a suitable directory under <code>\$JBOSS_SERVER_HOME/work/</code> is used)</p> <p>Each application has its own sub-directory with temporary read-write use. The directory can be made visible for servlets in the web application using the <code>javax.servlet.context.tempdir</code> servlet context attribute of type <code>java.io.File</code> as described in the Servlet Specification.</p> <p>If a child Context defines the <code>workDir</code> property, the Host's <code>workDir</code> is overridden.</p>

#### 4.6.2.1. Defining Host Name Aliases

If more than one network name in the Domain Name Service server are resolved to the IP address of the same server, use the Host's `Alias` element to define such network name resolution.

```
<Host name="www.company.com" ...>
  ...
  <Alias>company.com</Alias>
  ...
</Host>
```

Make sure the network names involved are registered in your DNS server and resolve to the same computer with the JBoss Web instance.

### 4.6.3. Context

The **Context** element represents a web application, which runs within a particular virtual host.

The web application used to process a particular HTTP request is selected based on matching the longest possible prefix of the Request URI against the context path of every Context. Once selected, the Context selects the appropriate servlet to process the incoming request as defined by servlet mappings in the web application deployment descriptor file (`/WEB-INF/web.xml` in the web application directory hierarchy).

You may define an arbitrary number of Context elements; however, each Context *must* have a unique context path. In addition, one Context with an empty context path (zero-length string) must be defined. This Context is used as the default web application for the virtual host and processes any requests with an unmatched context path.

#### 4.6.3.1. Defining Context

Contexts can be specified with explicitly defined Context elements or they can be created automatically.

To specify the context explicitly, define the **Context** element in some of the following locations depending on the desired behavior:

- `$JBOSS_SERVER_HOME/conf/context.xml`: the Context element is loaded by all web applications on the server.
- `$JBOSS_SERVER_HOME/conf/enginename/hostname/context.xml` file: the Context element is loaded by all web applications on the host.
- `$JBOSS_SERVER_HOME/conf/enginename/hostname/` directory as individual files with the `xml` extension: The name of the `xml` file is used as the context path. To define a multi-level context path, separate the domains with the hash sign (that is, #); for example, the `foo#bar.xml` file will be resolved as the context path `/foo/bar`. Define the default web application file as the `ROOT.xml` file.
- `/META-INF/context.xml` in the web application: this context definition is applied only if there is no context file for the application in the `$JBOSS_SERVER_HOME/conf/enginename/hostname/` directory.

If the web application is deployed as a WAR archive, its `/META-INF/context.xml` file is copied to `$JBOSS_SERVER_HOME/conf/enginename/hostname/` directory and renamed to match the application's context path. Mind that the file will not be replaced if a new WAR with a newer `/META-INF/context.xml` file is placed in the host's appBase.

- In a **Host** element in the main `server.xml` file.



#### IMPORTANT

It is not recommended to place the `<Context>` element in the `server.xml` file. Such context definitions require more invasive approach when modifying the Context configuration since the main `$JBOSS_SERVER_HOME/conf/server.xml` file cannot be reloaded without restarting the JBoss Web server.

Table 4.8. Context Element Attributes

Attribute	Description
backgroundProcessorDelay	<p>Delay between the invocation of the <b>backgroundProcess</b> method on the context and the invocation of the <b>backgroundProcess</b> method on the child containers of the context (-1 by default and the context relies therefore on the background processing of its parent host)</p> <p>If set to a positive value, the context produces a thread. The thread waits for the specified amount of time and then invokes the <b>backgroundProcess</b> method on the context and all its child containers.</p> <p>If the delay of a child container is not negative, the child container is using its own processing thread.</p> <p>A context uses background processing to perform session expiration and class monitoring for reloading.</p>
className	<p>Class implementing the Context</p> <p>This class must implement the <code>org.apache.catalina.Context</code> interface. If not specified, the <b>org.apache.catalina.core.StandardContext</b> standard value is used.</p>
cookies	<p>Use cookies for session identifier communication if supported by the client (<b>true</b> by default)</p> <p>Set to <b>false</b> if you want to disable the feature. The server relies then only on URL rewriting performed by the application.</p>
crossContext	<p>Returning of the context to other web applications (defines the response sent to the <code>ServletContext.getContext()</code> call; set to <b>false</b> by default and the request dispatcher is filled with the NULL value)</p> <p>If set to <b>true</b>, the context returns the request dispatcher with the <code>ServletContext</code> value to the requesting web application. The requesting web application must run on the same virtual host.</p>
docBase	<p>Document Base, that is the Context Root directory, of the web application or the pathname to the web application archive file</p> <p>You can define the <code>docBase</code> value as an absolute pathname to the directory or WAR file, or as a pathname relative to the <code>appBase</code> directory of the parent Host.</p>
override	<p>Overriding of explicit settings in the Context element by the corresponding settings in the global or host default contexts (set to use the default context setting)</p> <p>Set to <b>true</b> to activate the overriding.</p> <p>If the <code>docBase</code> value is defined as a symbolic link, changes to the symbolic link take effect only after the JBoss Web server is restarted or after the context is undeployed and then re-deployed: context reload is not sufficient.</p>

Attribute	Description
privileged	<p>Enabling/disabling the context to use container servlets, such as the manager servlet</p> <p>The <b>privileged</b> attribute changes the context's parent class loader to the Server class loader rather than the Shared class loader (the Common class loader is used for the Server and the Shared class loaders by default).</p> <p>Set to <b>true</b> to allow the context to use container servlets.</p>
path	<p>Context path of the web application.</p> <p>The path is matched against the beginning of each request URI to select the appropriate web application for the request processing. Therefore all context paths within a particular host must be unique.</p> <p>To use the context as the default web application for the host, specify the context path as an empty string (""). The default web application processes any requests, which could not be assigned to any other Context.</p> <p><b>Do not set the value of this field unless you want to define the context statically in <code>server.xml</code> as its value is inferred from the file names used for the <code>xml</code> context file or <code>thdocBase</code> property.</b></p>
reloadable	<p>Enabling/disabling the monitoring of class changes in <code>/WEB-INF/classes/</code> and <code>/WEB-INF/lib</code> and automatic reloading of the web application if a change is detected (<b>false</b> by default).</p> <p>Note that this feature requires significant runtime overhead and is not recommended for production applications (to reload deployed applications, use the Manager web application).</p>
WrapperClass	<p>Class implementing the <code>org.apache.catalina.Wrapper</code> interface used for servlets in this context</p> <p>If no value is specified, the standard default value is used.</p>

**Table 4.9. Additional Element Attributes of the Standard Context Element Implementation (`org.apache.catalina.core.StandardContext`)**

Attribute	Description
allowLinking	<p>Enabling/disabling the usage of symlinks inside the web application if the symlinks point to resources outside of the web application Base directory (set to <b>false</b> by default)</p> <p>Set to <b>true</b> to allow such symlinks in the web application.</p> <p>This property <b>must not</b> be set to <b>true</b> on Windows platforms or any other operating systems with case-insensitive file systems as this can result in various security problem, such as disabling of case sensitivity checks and possible disclosure of JSP source code.</p>

Attribute	Description
antiJARLocking	<p>Enabling/disabling extra measures for keeping JAR files unlocked even if being accessed through URLs (<b>false</b> by default)</p> <p>Enabling this feature prolongs the start time of applications.</p>
antiResourceLocking	<p>Enabling/disabling file locking by JBoss Web (<b>false</b> by default)</p> <p>Enabling this features allows full hot deploy and undeploy on platforms or configurations where file locking can occur. However, enabling this feature significantly impacts the start time of applications along with other side effects, such as disabling of JSP reloading in a running server and application deletion on JBoss Web shutdown if the application is outside of the appBase for the Host (in the <b>webapps</b> directory by default).</p>
cacheMaxSize	<p>Defines the maximum size of the static resource cache in kilobytes (set to <b>10240</b>, that is 10 megabytes by default)</p>
cacheTTL	<p>Defines the amount of time in milliseconds between cache entries revalidation (set to <b>5000</b>, that is 5 seconds, by default)</p>
cachingAllowed	<p>Enabling the usage of the cache for static resources (set to <b>true</b> by default)</p>
caseSensitive	<p>Enabling case sensitivity checks (set to <b>false</b> by default)</p> <p>Set to <b>false</b> to disable all case sensitivity checks.</p> <p><b>Do not set the property false on Windows platforms or any operating systems that do not have a case sensitive file system as this might result in various security issues including JSP source code disclosure.</b></p>
processTlds	<p>Enabling processing of tag library descriptors (TLD) on context start up (set to <b>true</b> by default)</p> <p>Set to <b>false</b> if TLDs are not part of the web application.</p>
swallowOutput	<p>Enabling redirection of System.out and System.err output to the web application logger (<b>false</b> by default)</p> <p>Set to <b>true</b> to redirect the output to the web application logger.</p>
tldNamespaceAware	<p>Enabling the TLD files XML validation to be namespace-aware (<b>false</b> by default)</p> <p>The feature is usually enabled along with tldValidation.</p>
tldValidation	<p>Enabling the TLD files XML validation on context start up (<b>false</b> by default)</p>

Attribute	Description
unloadDelay	Amount of time (in ms) the container waits for servlets to unload ( <b>2000</b> ms by default)
unpackWAR	Enabling unpacking of compressed web applications before they are run ( <b>true</b> by default)
useNaming	Enabling a JNDI InitialContext that is compatible with Java Enterprise Edition (JEE) conventions ( <b>true</b> by default)
workDir	<p>Path to a directory provided by this Context for temporary read-write use to the servlets in the associated web application</p> <p>The directory is visible for servlets in the web application through the <code>javax.servlet.context.tempdir</code> servlet context attribute (of type <code>java.io.File</code>) named as described in the Servlet Specification. If not specified, a suitable directory under <code>\$JBOSS_SERVER_HOME/work/</code> is provided.</p>

### Context FAQs

#### Context FAQs

**Q: What is context.xml?**

**A: context.xml** is a Tomcat configuration file that is used to configure many webapp settings on a per-webapp basis.

Recent versions of JBoss Enterprise Application Platform allow you to place a `context.xml` file in the `WEB-INF` directory of your WAR archive.

The JBoss Enterprise Application Platform distribution comes with some in-place `context.xml` files. They can be found at

`<JBOSS_HOME>/server/<PROFILE>/deploy/management/console-mgr.sar/web-console.war/WEB-INF/context.xml` and  
`<JBOSS_HOME>/server/<PROFILE>/deploy/jbossweb.sar/context.xml`.

**Q: Why is context.xml placed in WEB-INF in JBoss deployments but META-INF in Tomcat?**

**A: The justification for this is that a WAR archive does not require a META-INF directory however a WEB-INF directory is required.**

**Q: What is the difference between jboss-web.xml and context.xml?**

**A: Because there is some overlap between jboss-web.xml and context.xml, there is some confusion over how and when context.xml should be used.**

The general rule is that if you can set a parameter in `jboss-web.xml` then the `context.xml` equivalent is ignored.

**Q: Why is context.xml needed at all?**

**A:** The reason we need `context.xml` is that there are some things that are used to configure Tomcat as opposed to the JBoss wrapper around Tomcat. Some examples of ways you would use `context.xml` are found here:

<https://community.jboss.org/wiki/ExtendedFormAuthenticator>

<https://community.jboss.org/wiki/DisableSessionPersistence>

<https://community.jboss.org/wiki/LimitAccessToCertainClients>

**Q:** Why is not `context.xml` usage better documented?

**A:** Partially because `context.xml` has no DTD. There is no exhaustive list of possible elements and overlaps with `jboss-web.xml`.

The *path* attribute is the most commonly cited overlap `jboss-web.xml`. You should set the *context-root* in `jboss-web.xml`.

**Q:** How do I remove the `jsessionid` from URLs?

**A:** To have the `jsessionids` removed from URLs, do the following:

1. Create the following `JsessionIdRemoveFilter.java` in your code base:

```
import java.io.IOException;

import javax.servlet.Filter;
import javax.servlet.FilterChain;
import javax.servlet.FilterConfig;
import javax.servlet.ServletException;
import javax.servlet.ServletRequest;
import javax.servlet.ServletResponse;
import javax.servlet.http.HttpServletRequest;
import javax.servlet.http.HttpServletResponse;
import javax.servlet.http.HttpServletResponseWrapper;

public class JsessionIdRemoveFilter implements Filter {

    public void doFilter(ServletRequest req, ServletResponse
res, FilterChain chain)
        throws IOException, ServletException {

        if (!(req instanceof HttpServletRequest)) {
            chain.doFilter(req, res);
            return;
        }

        HttpServletRequest request = (HttpServletRequest) req;
        HttpServletResponse response = (HttpServletResponse)
res;

        // Redirect requests with JSESSIONID in URL to clean
version (old links bookmarked/stored by bots)
        // This is ONLY triggered if the request did not also
```

```

    contain a JSESSIONID cookie! Which should be fine for bots...
    if (request.isRequestedSessionIdFromURL()) {
        String url = request.getRequestURL()
            .append(request.getQueryString() !=
null ? "?" + request.getQueryString() : "")
            .toString();
        response.setHeader("Location", url);

response.sendError(HttpServletResponse.SC_MOVED_PERMANENTLY);
        return;
    }

    // Prevent rendering of JSESSIONID in URLs for all
outgoing links
    HttpServletResponseWrapper wrappedResponse =
        new HttpServletResponseWrapper(response) {
            @Override
            public String encodeRedirectUrl(String url) {
                return url;
            }

            @Override
            public String encodeRedirectURL(String url) {
                return url;
            }

            @Override
            public String encodeUrl(String url) {
                return url;
            }

            @Override
            public String encodeURL(String url) {
                return url;
            }
        };
    chain.doFilter(req, wrappedResponse);
}

public void destroy() {
}

public void init(FilterConfig arg0) throws
ServletException {
}
}

```

2. Add the following to the `web.xml` file to have the filter deployed:

```

<filter>
  <filter-name>JsessionIdRemoveFilter</filter-name>
  <filter-class>com.example.JsessionIdRemoveFilter</filter-
class>
</filter>
<filter-mapping>

```



```

    <filter-name>JsessionIdRemoveFilter</filter-name>
    <url-pattern>/*</url-pattern>
</filter-mapping>

```

As this disables URL rewriting, the site no longer works without cookies and an additional cookie check might be needed.

## 4.7. NESTED COMPONENTS

Nested components are optional elements nested in other elements while not nesting any elements themselves.

Nested element are **Realm**, **Valve**, **Resources**, **Manager**, **Loader**, and **GlobalNamingResources**.

### 4.7.1. Realm

The **Realm** element can be defined either in the **Engine** element or in the **Host** element. It defines the security applied to the received requests and thus integrates the JBoss Web server into JBoss SX.

The **Realm** element supports the following attributes: TBD

### 4.7.2. Valve

The **Valve** element "catches" requests before they are received by the respective container and executes the code defined. The element is nested in the **Container** element, which represents the container to catch the requests from; that is **Engine**, **Host**, or **Context** container.

Valves have been provided as an alternative to filters and are the recommended solution.

### 4.7.3. GlobalNamingResources

The **GlobalNamingResources** element defines the global JNDI resources for the Server.

The global JNDI resources are listed in the server's global JNDI resource context. The resources defined in this element are not visible in the per-web-application contexts unless you explicitly link them with `__ResourceLink__` elements.

You can configure named values that will be visible to all web applications as environment entry resources in the **Environment** element nested in the **GlobalNamingResources** element.

```

<GlobalNamingResources ...>
...
<Environment name="maxExemptions" value="10"
    type="java.lang.Integer" override="false"/>
...
</GlobalNamingResources>

```

The **Environment** element supports the following attributes:

- **description**: optional human-readable description of the element

- **name:** name of the environment entry to be created relative to the `java:comp/env` context
- **override:** Set this to `false` if you do not want an `__env-entry__` for the same environment entry name, found in the web application deployment descriptor, to override the value specified here. By default, overrides are allowed.
- **type:** The fully qualified Java class name expected by the web application for this environment entry. Must be one of the legal values for `__env-entry-type__` in the web application deployment descriptor: `java.lang.Boolean`, `java.lang.Byte`, `java.lang.Character`, `java.lang.Double`, `java.lang.Float`, `java.lang.Integer`, `java.lang.Long`, `java.lang.Short`, or `java.lang.String`.
- **value:** The parameter value that will be presented to the application when requested from the JNDI context. This value must be convertible to the Java type defined by the `type` attribute.

## CHAPTER 5. ENTERPRISE APPLICATIONS WITH EJB3 SERVICES

EJB3 (Enterprise Java Bean 3.0) provides the core component model for Java EE 5 applications. An EJB3 bean is a managed component that is automatically wired to take advantage of all services the Java EE 5 server container provides, such as transaction, security, persistence, naming, dependency injection, etc. The managed component allows developers to focus on the business logic, and leave the cross-cutting concerns to the container as configurations. As an application developer, you need not create or destroy the components yourself. You only need to ask for an EJB3 bean from the Java EE container by its name, and then you can call its methods with all configured container services applied. You can get access to an EJB3 bean from either inside or outside of the Java EE container.

JBoss Enterprise Application Platform 5 supports EJB3 out of the box. Note that JBoss Enterprise Application Platform 4.2 is a J2EE server, so it does not support the full EJB3 feature set.

The details of the EJB3 component programming model is beyond the scope of this guide. Most EJB3 interfaces and annotations are part of the Java EE 5 standard and hence they are the same for all Java EE 5 compliant application servers. Interested readers should refer to the EJB3 specification or numerous EJB3 books to learn more about EJB3 programming.

In this chapter, we only cover EJB3 configuration issues that are specific to the JBoss Enterprise Application Platform. For instance, we discuss the JNDI naming conventions for EJB3 components inside the JBoss Enterprise Application Platform, the optional configurations for the Hibernate persistence engine for entity beans, as well as custom options in the JBoss EJB3 deployer.

### 5.1. SESSION BEANS

Session beans are widely used to provide transactional services for local and remote clients. To write a session bean, you need an interface and an implementation class.

```
@Local
public interface MyBeanInt {
    public String doSomething (String para1, int para2);
}

@Stateless
public class MyBean implements MyBeanInt {

    public String doSomething (String para1, int para2) {
        ... implement the logic ...
    }
}
```

When you invoke a session bean method, the method execution is automatically managed by the transaction manager and the security manager in the server. You can specify the transactional or security properties for each method using annotations on the method. A session bean instance can be reused by many clients.

Depending on whether or not the server maintains the bean's internal state between multiple invocations coming from the same client, the session bean can be stateless or stateful. If the bean has a remote business interface clients outside of the current JVM can call the EJB3 bean. All these are

configurable via standard annotations on the beans. Note that the transactional or security properties are only active when the bean is called through a business interface.

After you define a session bean, how does the client get a reference to it? As we discussed, the client does not create or destroy EJB3 components, it merely asks the server for a reference of an existing instance managed by the server. That is done via JNDI. In JBoss Enterprise Application Platform, the default local JNDI name for a session bean is dependent on the deployment packaging of the bean class.

- If the bean is deployed in a standalone JAR file in the `<JBOSS_HOME>/default/deploy` directory, the bean is accessible via local JNDI name `MyBean/local`, where `MyBean` is the implementation class name of the bean as we showed earlier. The "local" JNDI in JBoss Enterprise Application Platform means that the JNDI name is relative to `java:comp/env/`.
- If the JAR file containing the bean is packaged in an EAR file, the local JNDI name for the bean is `myapp/MyBean/local`, where `myapp` is the root name of the EAR archive file (e.g., `myapp.ear`, see later for the EAR packaging of EJB3 beans).

Of course, you should change `local` to `remote` if the bean interface is annotated with `@Remote` and the bean is accessed from outside of the server it is deployed on. Below is the code snippet to get a reference of the `MyBean` bean in a web application (e.g., in a servlet or a JSF backing bean) packaged in `myapp.ear`, and then invoke a managed method.

```
try {
    InitialContext ctx = new InitialContext();
    MyBeanInt bean = (MyBeanInt) ctx.lookup("myapp/MyBean/local");
} catch (Exception e) {
    e.printStackTrace ();
}

... ..

String result = bean.doSomething("have fun", 1);

... ..
```

What the client gets from the JNDI is essentially a "stub" or "proxy" of the bean instance. When the client invokes a method, the proxy figures out how to route the request to the server and marshal together the response.

If you do not like the default JNDI names, you can always specify your own JNDI binding for any bean via the `@LocalBinding` annotation on the bean implementation class. The JNDI binding is always "local" under the `java:comp/env/` space. For instance, the following bean class definition results in the bean instances available under JNDI name `java:comp/env/MyService/MyOwnName`.

```
@Stateless
@LocalBinding (jndiBinding="MyService/MyOwnName")
public class MyBean implements MyBeanInt {

    public String doSomething (String para1, int para2) {
        ... implement the logic ...
    }
}
```

}

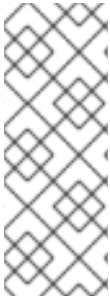
**NOTE**

Java EE 5 allows you to inject EJB3 bean instances directly into the web application via annotations without explicit JNDI lookup. This behavior is not yet supported in JBoss Enterprise Application Platform 5.2. However, the JBoss Enterprise Platform provides an integration framework called JBoss Seam. JBoss Seam brings EJB3 / JSF integration to new heights far beyond what Java EE 5 provides. Please see more details in the *JBoss Seam Reference Guide* bundled with the platform.

## 5.2. ENTITY BEANS (A.K.A. JAVA PERSISTENCE API)

EJB3 session beans allow you to implement data accessing business logic in transactional methods. To actually access the database, you will need EJB3 entity beans and the entity manager API. They are collectively called the Java Persistence API (JPA).

EJB3 Entity Beans are Plain Old Java Objects (POJOs) that map to relational database tables. For instance, the following entity bean class maps to a relational table named customer. The table has three columns: name, age, and signupdate. Each instance of the bean corresponds to a row of data in the table.

```
@Entity
public class Customer {

    String name;

    public String getName () {
        return name;
    }

    public void setName (String name) {
        this.name = name;
    }

    int age;

    public int getAge () {
        return age;
    }

    public void setAge (int age) {
        this.age = age;
    }

    Date signupdate;

    public Date getSignupdate () {
        return signupdate;
    }

    public void setSignupdate (Date signupdate) {
```

```
        this.signupdate = signupdate;
    }
}
```

Besides simple data properties, the entity bean can also contain references to other entity beans with relational mapping annotations such as `@OneToOne`, `@OneToMany`, `@ManyToMany` etc. The relationships of those entity objects will be automatically set up in the database as foreign keys. For instance, the following example shows that each record in the Customer table has one corresponding record in the Account table, multiple corresponding records in the Order table, and each record in the Employee table has multiple corresponding records in the Customer table.

```
@Entity
public class Customer {

    ... ..

    Account account;

    @OneToOne
    public Account getAccount () {
        return account;
    }

    public void setAccount (Account account) {
        this.account = account;
    }

    Employee salesRep;

    @ManyToOne
    public Employee getSalesRep () {
        return salesRep;
    }

    public void setSalesRep (Employee salesRep) {
        this.salesRep = salesRep;
    }

    Vector <Order> orders;

    @OneToMany
    public Vector <Order> getOrders () {
        return orders;
    }

    public void setOrders (Vector <Order> orders) {
        this.orders = orders;
    }
}
```

Using the EntityManager API, you can create, update, delete, and query entity objects. The EntityManager transparently updates the underlying database tables in the process. You can obtain an EntityManager object in your EJB3 session bean via the `@PersistenceContext` annotation.

```

@PersistenceContext
EntityManager em;

Customer customer = new Customer ();
// populate data in customer

// Save the newly created customer object to DB
em.persist (customer);

// Increase age by 1 and auto save to database
customer.setAge (customer.getAge() + 1);

// delete the customer and its related objects from the DB
em.remove (customer);

// Get all customer records with age > 30 from the DB
List <Customer> customers = em.query (
    "select c from Customer as c where c.age > 30");

```

The detailed use of the EntityManager API is beyond the scope of this book. Interested readers should refer to the JPA documentation or Hibernate EntityManager documentation.

### 5.2.1. The persistence.xml file

The EntityManager API is great, but how does the server know which database it is supposed to save / update / query the entity objects? How do we configure the underlying object-relational-mapping engine and cache for better performance and trouble shooting? The persistence.xml file gives you complete flexibility to configure the EntityManager.

The persistence.xml file is a standard configuration file in JPA. It has to be included in the META-INF directory inside the JAR file that contains the entity beans. The persistence.xml file must define a persistence-unit with a unique name in the current scoped classloader. The provider attribute specifies the underlying implementation of the JPA EntityManager. In JBoss Enterprise Application Platform, the default and only supported / recommended JPA provider is Hibernate. The jta-data-source points to the JNDI name of the database this persistence unit maps to. The java:/DefaultDS here points to the HSQL DB embedded in the JBoss Enterprise Application Platform. Please refer to [Chapter 16, Using Production Databases with JBoss Enterprise Application Platform](#) on how to setup alternative databases for JBoss Enterprise Application Platform.

```

<persistence>
  <persistence-unit name="myapp">
    <provider>org.hibernate.ejb.HibernatePersistence</provider>
    <jta-data-source>java:/DefaultDS</jta-data-source>
    <properties>
      ... ..
    </properties>
  </persistence-unit>
</persistence>

```

**NOTE**

Since you might have multiple instances of persistence-unit defined in the same application, you typically need to explicitly tell the `@PersistenceContext` annotation which unit you want to inject. For instance, `@PersistenceContext(name="myapp")` injects the `EntityManager` from the persistence-unit named "myapp".

However, if you deploy your EAR application in its own scoped classloader and have only one persistence-unit defined in the whole application, you can omit the "name" on `@PersistenceContext`. See later in this chapter for EAR packaging and deployment.

The properties element in the persistence.xml can contain any configuration properties for the underlying persistence provider. Since JBoss Enterprise Application Platform uses Hibernate as the EJB3 persistence provider, you can pass in any Hibernate options here. Please refer to the Hibernate and Hibernate EntityManager documentation for more details. Here we will just give an example to set the SQL dialect of the persistence engine to HSQL, and to create tables from the entity beans when the application starts and drop those tables when the application stops.

```
<persistence>
  <persistence-unit name="myapp">
    <provider>org.hibernate.ejb.HibernatePersistence</provider>
    <jta-data-source>java:/DefaultDS</jta-data-source>
    <properties>
      property name="hibernate.dialect"
        value="org.hibernate.dialect.HSQLDialect"/>
      <property name="hibernate.hbm2ddl.auto" value="create-drop"/>
    </properties>
  </persistence-unit>
</persistence>
```

### 5.2.2. Use Alternative Databases

To use an alternative database other than the built-in HSQL DB to back your entity beans, you need to first define the data source for the database and register it in the JNDI. This is done via the `*-ds.xml` files in the deploy directory. Examples of `*-ds.xml` files for various databases are available in `<JBOSS_HOME>/docs/examples/jca` directory in the server.

Then, in the persistence.xml, you need to change the `jta-data-source` attribute to point to the new data source in JNDI (e.g., `java:/MysqlDS` if you are using the default `mysql-ds.xml` to setup a MySQL external database).

In most cases, Hibernate tries to automatically detect the database it connects to and then automatically selects an appropriate SQL dialect for the database. However, we have found that this detection does not always work, especially for less used database servers. We recommend you to set the `hibernate.dialect` property explicitly in persistence.xml. Here are the Hibernate dialect for database servers officially supported on the JBoss platform.

- Oracle 9i and 10g: `org.hibernate.dialect.Oracle9Dialect`
- Microsoft SQL Server 2005: `org.hibernate.dialect.SQLServerDialect`
- PostgreSQL 8.1: `org.hibernate.dialect.PostgreSQLDialect`



- MySQL 5.0: org.hibernate.dialect.MySQL5Dialect
- DB2 8.0: org.hibernate.dialect.DB2Dialect
- Sybase ASE 12.5: org.hibernate.dialect.SybaseDialect

### 5.2.3. Default Hibernate Options

Hibernate has many configuration properties. JBoss Enterprise Application Platform uses default values for the properties that you do not specify in the `persistence.xml` file. The default Hibernate property values are specified in the `PersistenceUnitDeployer` bean definition in the `JBOSS_HOME/server/PROFILE/deployers/ejb3.deployer/META-INF/jpa-deployers-jboss-beans.xml` file. Below is the code of the bean used in JBoss Enterprise Application Platform 5. Notice the options that are commented out. These are the properties available in the `persistence.xml` file.

```
<bean name="PersistenceUnitDeployer"
class="org.jboss.jpa.deployers.PersistenceUnitDeployer">
  <property name="defaultPersistenceProperties">
    <map keyClass="java.lang.String" valueClass="java.lang.String">
      <entry>
        <key>hibernate.transaction.manager_lookup_class</key>
        <value>org.hibernate.transaction.JBossTransactionManagerLookup</value>
      </entry>
      <!--entry>
        <key>hibernate.connection.release_mode</key>
        <value>after_statement</value>
      </entry-->
      <!--entry>
        <key>hibernate.transaction.flush_before_completion</key>
        <value>>false</value>
      </entry-->
      <!--entry>
        <key>hibernate.transaction.auto_close_session</key>
        <value>>false</value>
      </entry-->
      <!--entry>
        <key>hibernate.query.factory_class</key>
        <value>org.hibernate.hql.ast.ASTQueryTranslatorFactory</value>
      </entry-->
      <!--entry>
        <key>hibernate.hbm2ddl.auto</key>
        <value>create-drop</value>
      </entry-->
      <entry>
        <key>hibernate.cache.provider_class</key>
        <value>org.hibernate.cache.HashtableCacheProvider</value>
      </entry>
      <!-- Clustered cache with JBoss Cache -->
      <!--entry>
        <key>hibernate.cache.region.factory_class</key>
        <value>org.hibernate.cache.jbc2.JndiMultiplexedJBossCacheRegionFactory</value>
      </entry>
```

```

<entry>
<key>hibernate.cache.region.jbc2.cachefactory</key>
<value>java:CacheManager</value>
</entry>
<entry>
<key>hibernate.cache.region.jbc2.cfg.entity</key>
<value>pessimistic-entity</value>
</entry>
<entry>
<key>hibernate.cache.region.jbc2.cfg.query</key>
<value>local-query</value>
</entry-->
<!--entry-->
<key>hibernate.dialect</key>
<value>org.hibernate.dialect.HSQLDialect</value>
</entry-->
<entry>
<key>hibernate.jndi.java.naming.factory.initial</key>
<value>org.jnp.interfaces.NamingContextFactory</value>
</entry>
<entry>
<key>hibernate.jndi.java.naming.factory.url.pkgs</key>
<value>org.jboss.naming:org.jnp.interfaces</value>
</entry>
<entry>
<key>hibernate.bytecode.use_reflection_optimizer</key>
<value>>false</value>
</entry>
<entry>
<key>hibernate.bytecode.provider</key>
<value>javassist</value>
</entry>
</map>
</property>
</bean>

```

### 5.3. MESSAGE DRIVEN BEANS

Message driven beans are specialized EJB3 beans that receive service requests via JMS messages instead of proxy method calls from the "stub". So, a crucial configuration parameter for the message driven bean is to specify which JMS message queue it listens to. When there is an incoming message in the queue, the server invokes the bean's `onMessage()` method, and passes in the message itself for processing. The bean class specifies the JMS queue it listens to in the `@MessageDriven` annotation. The queue is registered under the local JNDI `java:comp/env/` name space.

```

@MessageDriven(activationConfig =
{
    @ActivationConfigProperty(propertyName="destinationType",
        propertyValue="javax.jms.Queue"),
    @ActivationConfigProperty(propertyName="destination",
        propertyValue="queue/MyQueue")
})
public class MyJmsBean implements MessageListener {

```

```

public void onMessage (Message msg) {
    // ... do something with the msg ...
}

// ... ..
}

```

When a message driven bean is deployed, its incoming message queue is automatically created if it does not exist already. To send a message to the bean, you can use the standard JMS API.

```

try {
    InitialContext ctx = new InitialContext();
    queue = (Queue) ctx.lookup("queue/MyQueue");
    QueueConnectionFactory factory =
        (QueueConnectionFactory) ctx.lookup("ConnectionFactory");
    cnn = factory.createQueueConnection();
    sess = cnn.createQueueSession(false,
        QueueSession.AUTO_ACKNOWLEDGE);
} catch (Exception e) {
    e.printStackTrace ();
}

TextMessage msg = sess.createTextMessage(...);

sender = sess.createSender(queue);
sender.send(msg);

```

Please refer to the JMS specification or books to learn how to program in the JMS API.

## 5.4. PACKAGE AND DEPLOY EJB3 SERVICES

EJB3 bean classes are packaged in regular JAR files. The standard configuration files, such as `ejb-jar.xml` for session beans, and `persistence.xml` for entity beans, are in the `META-INF` directory inside the JAR. You can deploy EJB3 beans as standalone services in JBoss Enterprise Application Platform or as part of an enterprise application (i.e., in an EAR archive). In this section, we discuss those two deployment options.

### 5.4.1. Deploy the EJB3 JAR

When you drop JAR files into the `<JBOSS_HOME>/server/<JBOSS_HOME>/deploy/` directory, it will be automatically picked up and processed by the server. All the EJB3 beans defined in the JAR file will then be available to other applications deployed inside or outside of the server via JNDI names like `MyBean/localhost`, where `MyBean` is the implementation class name for the session bean. The deployment is done via the JBoss EJB3 deployer in `<JBOSS_HOME>/server/<PROFILE>/ejb3.deployer/`. The `META-INF/persistence.properties` file we discussed earlier to configure the default behavior of EJB3 entity manager is located in the EJB3 deployer.

The EJB3 deployer automatically scans JARs on the classpath to look for EJB3 annotations. When it finds classes with EJB3 annotations, it would deploy them as EJB3 services. However, scanning all

JARs on the classpath could be very time-consuming if you have large applications with many JARs deployed. In the `<JBoss_HOME>/server/<JBoss_HOME>/deployers/ejb3.deployer/META-INF/ejb3-deployers-jboss-beans.xml` file, you can tell the EJB3 deployer to ignore JARs you know do not contain EJB3 beans. The non-EJB3 JAR files shipped with the JBoss Enterprise Application Platform are already listed in the `jboss.ejb3:service=JarsIgnoredForScanning` MBean service:

```

... ..
<mbean code="org.jboss.ejb3.JarsIgnoredForScanning"
      name="jboss.ejb3:service=JarsIgnoredForScanning">
  <attribute name="IgnoredJars">
    snmp-adaptor.jar,
    otherimages.jar,
    applet.jar,
    jcommon.jar,
    console-mgr-classes.jar,
    jfreechart.jar,
    juddi-service.jar,
    wsdl4j.jar,
    ... ..
    servlets-webdav.jar
  </attribute>
</mbean>
... ..

```

You can add any non-EJB3 JARs from your application to this list so that the server do not have to waste time scanning them. This could significantly improve the application start time in some cases.

#### 5.4.2. Deploy EAR with EJB3 JAR

Most Java EE applications are deployed as EAR archives. An EAR archive is a JAR file that typically contains a WAR archive for the web pages, servlets, and other web-related components, one or several EJB3 JARs that provide services (e.g., data access and transaction) to the WAR components, and some other support library JARs required by the application. An EAR file also have deployment descriptors such as `application.xml` and `jboss-app.xml`. Below is the basic structure of a typical EAR application.

```

myapp.ear
├── META-INF/
│   ├── application.xml
│   └── jboss-app.xml
├── myapp.war/
│   ├── web pages and JSP /JSF pages
│   └── WEB-INF
│       ├── web.xml
│       ├── jboss-web.xml
│       ├── faces-config.xml
│       ├── ...
│       ├── lib/
│       │   └── tag library JARs
│       └── classes/
│           └── servlets and other classes used by web pages
└── myapp.jar/

```

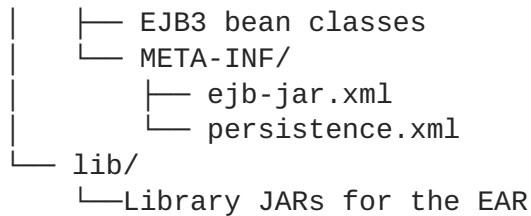

Notice that in JBoss Enterprise Application Platform, unlike in many other application servers, you do not need to declare EJB references in the web.xml file in order for the components in the WAR file to access EJB3 services. You can obtain the references directly via JNDI as we discussed earlier in the chapter.

A typical application.xml file is as follows. It declares the WAR and EJB3 JAR archives in the EAR, and defines the web content root for the application. Of course, you can have multiple EJB3 modules in the same EAR application. The application.xml file could also optionally define a shared classpath for JAR files used in this application. The JAR file location defaults to lib in JBoss Enterprise Application Platform -- but it might be different in other application servers.

```

<application>
  <display-name>My Application</display-name>

  <module>
    <web>
      <web-uri>myapp.war</web-uri>
      <context-root>/myapp</context-root>
    </web>
  </module>

  <module>
    <ejb>myapp.jar</ejb>
  </module>

  <library-directory>lib</library-directory>

</application>

```

The jboss-app.xml file provides JBoss-specific deployment configuration for the EAR application. For instance, it can specify the deployment order of modules in the EAR, deploy JBoss-specific application modules in the EAR, such as SARs (Service ARchive for MBeans) and HARs (Hibernate ARchive for Hibernate objects), provide security domain and JMX MBeans that can be used with this application, etc. You can learn more about the possible attributes in jboss-app.xml in its DTD: [http://www.jboss.org/j2ee/dtd/jboss-app\\_4\\_2.dtd](http://www.jboss.org/j2ee/dtd/jboss-app_4_2.dtd).

A common use case for jboss-app.xml is to configure whether this EAR file should be deployed in its own scoped classloader to avoid naming conflicts with other applications. If your EAR application is deployed in its own scoped classloader and it only has one persistence-unit defined in its EJB3 JARs, you will be able to use @PersistenceContext EntityManager to inject EntityManager to session beans without worrying about passing the persistence unit name to the @PersistenceContext annotation. The following jboss-app.xml specifies a scoped classloader myapp:archive=myapp.ear for the EAR application.

```

<jboss-app>
  <loader-repository>

```

```

    myapp:archive=myapp.ear
  </loader-repository>
</jboss-app>

```

The EAR deployment is configured by the `<JBOSS_HOME>/server/<PROFILE>/deploy/ear-deploy.xml` file. This file contains three attributes as follows.

```

<server>
  <mbean code="org.jboss.deployment.EARDeployer"
    name="jboss.j2ee:service=EARDeployer">
    <!--
      A flag indicating if ear deployments should
      have their own scoped class loader to isolate
      their classes from other deployments.
    -->
    <attribute name="Isolated">false</attribute>

    <!--
      A flag indicating if the ear components should
      have in VM call optimization disabled.
    -->
    <attribute name="CallByValue">false</attribute>

    <!--
      A flag the enables the default behavior of
      the ee5 library-directory. If true, the lib
      contents of an ear are assumed to be the default
      value for library-directory in the absence of
      an explicit library-directory. If false, there
      must be an explicit library-directory.
    -->
    <attribute name="EnablelibDirectoryByDefault">true</attribute>
  </mbean>
</server>

```

If you set the `Isolated` parameter to true, all EAR deployment will have scoped classloaders by default. There will be no need to define the classloader in `jboss-app.xml`. The `CallByValue` attribute specifies whether we should treat all EJB calls as remote calls. Remote calls have a large additional performance penalty compared with local call-by-reference calls, because objects involved in remote calls have to be serialized and de-serialized. For most of our applications, the WAR and EJB3 JARs are deployed on the same server, hence this value should be default to false and the server uses local call-by-reference calls to invoke EJB methods in the same JVM. The `EnablelibDirectoryByDefault` attribute specifies whether the lib directory in the EAR archive should be the default location for shared library JARs.

## CHAPTER 6. LOGGING

Logging is the most important tool to troubleshoot errors and monitor the status of the components of the Platform. `log4j` provides a familiar, flexible framework, familiar to Java developers.

[Section 6.1, “Logging Defaults”](#) contains information about customizing the default logging behavior for the Platform. See [Section 6.2, “Component-Specific Logging”](#) for additional customization.

[Appendix C, \*Logging Information and Recipes\*](#) provides some logging *recipes*, which you can customize to your needs.

### 6.1. LOGGING DEFAULTS

The `log4j` configuration is loaded from the `<JBOSS_HOME>/server/<PROFILE>/conf/jboss-log4j.xml` deployment descriptor. `log4j` uses *appenders* to control its logging behavior. An appender is a directive for where to log information, and how to do it. The `jboss-log4j.xml` file contains many sample appenders, including FILE, CONSOLE, and SMTP.

**Table 6.1. Common log4j Configuration Directives**

Configuration Option	Description
<code>appender</code>	The main appender. Gives the name and the implementing class.
<code>errorHandler</code>	Delegates an external class to handle exceptions passed to the logger, especially if the appender cannot write the log for some reason.
<code>param</code>	Options specific to the type of appender. In this instance, the <code>&lt;param&gt;</code> is the name of the file that stores the logs for the FILE appender.
<code>layout</code>	Controls the logging format. Tweak this to work with your log-parsing software of choice.

#### Example 6.1. Sample Appender

```
<appender name="FILE"
class="org.jboss.logging.appender.DailyRollingFileAppender">
  <errorHandler class="org.jboss.logging.util.OnlyOnceErrorHandler"/>
  <param name="File" value="{jboss.server.log.dir}/server.log"/>
  <param name="Append" value="true"/>
  <!-- In AS 5.0.x the server log threshold was set by a system
property.
In 5.1 and later, the system property sets the priority on the root
logger (see <root/> below)
  <param name="Threshold" value="{jboss.server.log.threshold}"/> -->

  <!-- Rollover at midnight each day -->
  <param name="DatePattern" value="'.'yyyy-MM-dd"/>
  <layout class="org.apache.log4j.PatternLayout">
  <!-- The default pattern: Date Priority [Category] (Thread) Message\n
-->
```

```
<param name="ConversionPattern" value="%d %-5p [%c] (%t) %m%n"/>
</layout>
</appender>
```

For more information on configuring **log4j**, see <http://logging.apache.org/log4j/1.2/>.

## 6.2. COMPONENT-SPECIFIC LOGGING

Some Platform components have extra logging options available, or extra mechanisms for customizing logging.

### 6.2.1. SQL Logging with Hibernate

Hibernate has two ways to enable logging of SQL statements. These statements are most useful during the testing and debugging phases of application development.

The first way is to explicitly enable it in your code.

```
SessionFactory sf = new Configuration()
    .setProperty("hibernate.show_sql", "true")
    // ...
    .buildSessionFactory();
```

Alternately, you can configure Hibernate to send all SQL messages to **log4j**, using a specific facility:

```
log4j.logger.org.hibernate.SQL=DEBUG, SQL_APPENDER
log4j.additivity.org.hibernate.SQL=false
```

The **additivity** option controls whether these log messages are propagated upward to parent handlers, and is a matter of preference.

### 6.2.2. Transaction Service Logging

The **TransactionManagerService** included with the Enterprise Platform handles logging differently than the stand-alone **Transaction Service**. Specifically, it overrides the value of the `com.arjuna.common.util.logger` property given in the `jbosstata-properties.xml` file, forcing use of the **log4j\_releveler** logger. All **INFO** level messages in the transaction code behave as **DEBUG** messages. Therefore, these messages are only present in log files if the filter level is **DEBUG**. All other log messages behave as normal.



## CHAPTER 7. DEPLOYMENT

Deploying applications on JBoss Enterprise Application Platform is achieved by copying the application into the `<JBOSS_HOME>/server/<PROFILE>/deploy` directory. Replace *default* with different server profiles such as *all* or *minimal* (server profiles are covered later in this guide). The JBoss Enterprise Application Platform constantly scans the deploy directory to pick up new applications or any changes to existing applications. This enables *hot deployment* of applications on the fly, while JBoss Enterprise Application Platform is still running.

### 7.1. DEPLOYABLE APPLICATION TYPES

With JBoss Enterprise Application Platform 4.x, a deployer existed to handle a specified deployment type and that was the only deployer that processed the deployment. In JBoss Enterprise Application Platform 5, multiple deployers transform the metadata associated with a deployment until it is processed by a deployer that creates a runtime component from the metadata.

Deployment has to contain a descriptor that causes the component metadata to be added to the deployment. The types of deployments for which deployers exist by default in the JBoss Enterprise Application Platform include:

#### WAR

The WAR application archive (e.g., `myapp.war`) packages Java EE web applications in a JAR file. It contains servlet classes, view pages, libraries, and deployment descriptors in `WEB-INF` such as `web.xml`, `faces-config.xml`, and `jboss-web.xml` etc..

#### EAR

The EAR application archive (e.g., `myapp.ear`) packages a Java EE enterprise application in a JAR file. It typically contains a WAR file for the web module, JAR files for EJB modules, as well as `META-INF` deployment descriptors such as `application.xml` and `jboss-app.xml` etc.

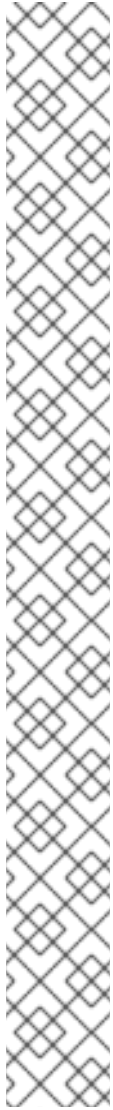

## NOTE

According to EJB3 specification, deployment of a persistence unit into an EAR should fail when the unit is outside of the EAR file and the bean attempting to inject the persistence unit is within the EAR. To follow the specification, you need to deploy the persistence unit packaged within the EAR file.

However, JBoss Enterprise Application Platform persistence units can exist outside of their EARs. To allow this behavior, modify the bean class of the **PersistenceUnitDependencyResolver** bean in the file **deployers/ejb3.deployer/META-INF/jpa-deployer-jboss-beans.xml** under the respective JBoss Enterprise Application Platform server profile:

```
<!--
Can be DefaultPersistenceUnitDependencyResolver for spec
compliant resolving,
InterApplicationPersistenceUnitDependencyResolver for
resolving beyond EARs,
or DynamicPersistenceUnitDependencyResolver which
allows configuration via JMX.
-->
<bean name="PersistenceUnitDependencyResolver"
class="org.jboss.jpa.resolvers.DynamicPersistenceUnitDependen
cyResolver"/>
```

The bean default value is **DynamicPersistenceUnitDependencyResolver**. This resolver allows you to specify the specification-compliant behavior, which can be additionally monitored through an MBean in the JMX Console. To use the spec-noncompliant JBoss variant, set the bean to **InterApplicationPersistenceUnitDependencyResolver**.

## JBoss Microcontainer

The JBoss Microcontainer (MC) beans archive (typical suffixes include, .beans, .deployer) packages a POJO deployment in a JAR file with a **META-INF/jboss-beans.xml** descriptor. This format is commonly used by the JBoss Enterprise Application Platform component deployers.

You can deploy **\*-jboss-beans.xml** files with MC beans definitions. If you have the appropriate JAR files available in the **deploy** or **lib** directories, the MC beans can be deployed using such a standalone XML file.

## SAR

The SAR application archive (e.g., **myservice.sar**) packages a JBoss service in a JAR file. It is mostly used by JBoss Enterprise Application Platform internal services that have not been updated to support MC beans style deployments.

You can deploy **\*-service.xml** files with MBean service definitions. If you have the appropriate JAR files available in the **deploy** or **lib** directories, the MBeans specified in the XML files will be started. This is the way you deploy many JBoss Enterprise Application Platform internal services that have not been updated to support POJO style deployment, such as the JMS queues.

## DataSource

The **\*-ds.xml** file defines connections to external databases. The data source can then be reused by all applications and services in JBoss Enterprise Application Platform via the internal JNDI.

## HAR

The HAR file defines Hibernate objects for an application. It resembles a SAR file but it contains the Hibernate class and mapping files, and a \*-hibernate.xml deployment descriptor in its META-INF directory.



### NOTE

The \*-hibernate.xml takes the same form as jboss-service.xml.

#### Example 7.1. A Hibernate deployment descriptor (\*-hibernate.xml)

```
<hibernate-configuration xmlns="urn:jboss:hibernate-
  deployer:1.0">
  <session-factory name="java:/hibernate/SessionFactory"
  bean="jboss.test.har:service=Hibernate, testcase=TimersUnitT
  estCase">
    <property name="datasourceName">OracleDS</property>
    <property
  name="dialect">org.hibernate.dialect.OracleDialect</propert
  y>
    <depends>jboss:service=Naming</depends>
    <depends>jboss:service=TransactionManager</depends>
  </session-factory>
</hibernate-configuration>
```

## \*AR

You can also deploy JAR files containing EJBs or other service objects directly in JBoss Enterprise Application Platform. The list of suffixes that are recognized as JAR files is specified in the `conf/bootstrap/deployers.xml` JARStructure bean constructor set.

### 7.1.1. Exploded Deployment

The WAR, EAR, MC beans and SAR deployment packages are JAR files with special XML deployment descriptors in directories like META-INF and WEB-INF. JBoss Enterprise Application Platform allows you to deploy the archives also as expanded directories instead of JAR files. This is called exploded deployment and allows you to make application changes on the fly, that is without re-deploying the entire application. If you need to re-deploy an exploded directory without restart the server, just **touch** the deployment descriptors (that is the `WEB-INF/web.xml` in a WAR and the `META-INF/application.xml` in an EAR) to update their timestamps.

## 7.2. STANDARD SERVER PROFILES

The JBoss Enterprise Application Platform ships with six server profiles. Each server profile is contained in a directory named `<JBOSS_HOME>/server/<PROFILE>/`. You can look into each server profile's directory to see the services, applications, and libraries included in the server profile.

**NOTE**

The exact contents of the `<JBoss_HOME>/server/<PROFILE>` directory depends on the server profile service implementation and is subject to change as the management layer and embedded server evolve.

**all**

The **all** profile provides clustering support and other enterprise extensions.

**production**

The *production* server profile is based on the **all** server profile and provides configuration optimized for production environments.

**minimal**

Starts the core server container without any of the enterprise services. Use the **minimal** server profile as a base to build a customized version of JBoss Enterprise Application Platform that only contains the services you need.

**default**

The **default** server profile is mostly used by application developers. It supports the standard Java EE 5.0 programming APIs (e.g., Annotations, JPA, and EJB3).

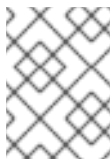
**NOTE**

The **default** server profile is used if a profile is not specified via the command-line or in a configuration file.

**standard**

The *standard* server profile is the server profile that has been tested for Java EE compliance. The major differences with the existing server profiles is that call-by-value and deployment isolation are enabled by default, along with support for **rmiiop** and **juddi** (taken from the *all* config).

**web**

The *web* server profile is an experimental, lightweight configuration created around JBoss Web that will follow the developments of the Java EE 6 web server profile. Except for the **servlet/jsp** container, it provides support for JTA/JCA and JPA. It also limits itself to allowing access to the server only through the http port. Please note that this server profile is not Java EE certified and will most likely change in the following releases.

The detailed services and APIs supported in each of those server profiles will be discussed throughout.

## 7.2.1. Changing Profile

If you want to change the profile used by the server, the method depends on whether the server was started at the command line or as a service.

If the server is being started at the command line, specify the required profile with the `-c` parameter: **run.sh -c profile**. For example, **run.sh -c all** on Red Hat Enterprise Linux or **run.bat -c all** command on Microsoft Windows starts the server in the *all* server profile.

If the server is being started as a service, reconfigure the profile used by the service then stop and restart the service. Refer to the *Run the Enterprise Application Platform as a Service* section of the *Installation Guide* for details of where the profile is specified.



### IMPORTANT

There is no `Server Started` message shown at the console when the server is started using the `production` profile. This message can be found in the `server.log` file located in the `<JBoss_HOME>/jboss-as/server/production/logs/log` subdirectory.

## 7.2.2. Creating Your Own Profile

When creating your own server profile, copy the profile that is closest to your needs and modify the contents.

### Example 7.2. Example: Create a New Server Profile

The following procedure is an example of how you might create a new server profile that does not require the `messaging` service:

#### Procedure 7.1.

1. Copy a suitable profile directory (`production`, for instance).
2. Rename the copied directory as desired (`myconfig`, for example).
3. Remove the `messaging` subdirectory from the `deploy` folder.
4. Start JBoss with the new profile using the command:

```
run -c myconfig
```



### NOTE

The `default` configuration is the one used if you do not specify another when starting up the server.

## 7.3. CONTEXT ROOT

The context root determines the URL of a deployed application. By default, the context root is identical with the application directory or archive structure; for example, if you deploy an `application.war` archive, which contains JSP pages in a `hello` directory, the JSPs in the `hello` directory will be available under `/application/hello/`.

### Procedure 7.2. Rewriting the Default Context Root

You can change the context root if required. To rewrite the context root, you need to define the new context root and allow the server to use the new context.

1. To define a new context root, add the `context-root` element with the new value to the deployment descriptor of the application:

- o To change the context root of a web application, add the context-root element to the `jboss-web.xml` file.

**Example 7.3. Example `jboss-web.xml` with a context root defined**

```
<?xml version="1.0"?>
<jboss-web>
  <context-root>/application-root</context-root>
</jboss-web>
```

The URL address for the application on localhost is  
`http://localhost:8080/application-root`

- o To change the context root of a servlet, change the url-pattern element in the `web.xml` file.

**Example 7.4. Example `web.xml` with a context root defined**

```
<?xml version="1.0"?>
<servlet-mapping>
  <servlet-name>MapRenderer</servlet-name>
  <url-pattern>/servlet-root</url-pattern>
</servlet-mapping>
```

The URL address for the servlet on localhost is  
`http://localhost:8080/application-root/servlet-root`

2. To start the server with the `REWRITE_CONTEXT_CHECK` variable set to `false`, run the following command: `run.sh -Dorg.apache.catalina.connector.Response.REWRITE_CONTEXT_CHECK=false`

## CHAPTER 8. MICROCONTAINER

JBoss Enterprise Application Platform 5.0 uses the Microcontainer to integrate enterprise services together with a Servlet/JSP container, EJB container, deployers and management utilities in order to provide a standard Java EE environment. If you need additional services, you can deploy these on top of Java EE to provide the functionality you need. Likewise any services that you do not need can be removed by changing the server profile configuration. You can even use the Microcontainer to do this in other environments such as Tomcat and GlassFish by plugging in different classloading models during the service deployment phase.

Since JBoss Microcontainer is very lightweight and deals with POJOs, it can also be used to deploy services into a Java ME runtime environment. This opens up new possibilities for mobile applications that can now take advantage of enterprise services without requiring a full JEE application server. As with other lightweight containers, JBoss Microcontainer uses dependency injection to wire individual POJOs together to create services. Configuration is performed using either annotations or XML depending on where the information is best located. Unit testing is made extremely simple thanks to a helper class that extends JUnit to setup the test environment, allowing you to access POJOs and services from your test methods using just a few lines of code.



### NOTE

For detailed information regarding the Microcontainer architecture, refer to the Microcontainer User Guide hosted on [docs.redhat.com](https://docs.redhat.com).

## CHAPTER 9. THE JNDI NAMING SERVICE

The naming service plays a key role in enterprise Java applications, providing the core infrastructure that is used to locate objects or services in an application server. It is also the mechanism that clients external to the application server use to locate services inside the application server. Application code, whether it is internal or external to the JBoss Enterprise Application Platform instance, needs only know that it needs to talk to the a message queue named `queue/IncomingOrders` and need not worry about any of the queue's configuration details.

In a clustered environment, naming services are even more valuable. A client of a service must be able to look up a `ProductCatalog` session bean from the cluster without needing to know which machine it resides on. Whether it is a large clustered service, a local resource or an application component that is needed, the JNDI naming service provides the glue that lets code find the objects in the system by name.

### 9.1. AN OVERVIEW OF JNDI

JNDI is a standard Java API that is bundled with the Java Development Kit. JNDI provides a common interface to a variety of existing naming services: DNS, LDAP, Active Directory, RMI registry, COS registry, NIS, and file systems. The JNDI API is divided logically into a client API that is used to access naming services, and a service provider interface (SPI) that allows the user to create JNDI implementations for naming services.

The SPI layer is an abstraction that naming service providers must implement to enable the core JNDI classes to expose the naming service using the common JNDI client interface. An implementation of JNDI for a naming service is referred to as a *JNDI provider*. JBoss naming is an example JNDI implementation, based on the SPI classes. Note that the JNDI SPI is not needed by J2EE component developers.

The main JNDI API package is the `javax.naming` package. It contains five interfaces, 10 classes, and several exceptions. There is one key class, `InitialContext`, and two key interfaces, `Context` and `Name`

#### 9.1.1. Names

The notion of a name is of fundamental importance in JNDI. The naming system determines the syntax that the name must follow. The syntax of the naming system allows the user to parse string representations of names into its components. A name is used with a naming system to locate objects. In the simplest sense, a naming system is just a collection of objects with unique names. To locate an object in a naming system you provide a name to the naming system, and the naming system returns the object store under the name.

As an example, consider the Unix file system's naming convention. Each file is named from its path relative to the root of the file system, with each component in the path separated by the forward slash character ("/"). The file's path is ordered from left to right. The pathname `/usr/jboss/readme.txt`, for example, names a file `readme.txt` in the directory `jboss`, under the directory `usr`, located in the root of the file system. JBoss Enterprise Application Platform naming uses a Unix-style namespace as its naming convention.

The `javax.naming.Name` interface represents a generic name as an ordered sequence of components. It can be a composite name (one that spans multiple namespaces), or a compound name (one that is used within a single hierarchical naming system). The components of a name are numbered. The indexes of a name with N components range from 0 up to, but not including, N. The most significant component is at index 0. An empty name has no components.



A composite name is a sequence of component names that span multiple namespaces. An example of a composite name would be the hostname and file combination commonly used with Unix commands like `scp`. For example, the following command copies `localfile.txt` to the file `remotefile.txt` in the `tmp` directory on host `ahost.someorg.org`:

```
scp localfile.txt ahost.someorg.org:/tmp/remotefile.txt
```

A compound name is derived from a hierarchical namespace. Each component in a compound name is an atomic name, meaning a string that cannot be parsed into smaller components. A file pathname in the Unix file system is an example of a compound name.

`ahost.someorg.org:/tmp/remotefile.txt` is a composite name that spans the DNS and Unix file system namespaces. The components of the composite name are `ahost.someorg.org` and `/tmp/remotefile.txt`. A component is a string name from the namespace of a naming system. If the component comes from a hierarchical namespace, that component can be further parsed into its atomic parts by using the `javax.naming.CompoundName` class. The JNDI API provides the `javax.naming.CompositeName` class as the implementation of the `Name` interface for composite names.

## 9.1.2. Contexts

The `javax.naming.Context` interface is the primary interface for interacting with a naming service. The `Context` interface represents a set of name-to-object bindings. Every context has an associated naming convention that determines how the context parses string names into `javax.naming.Name` instances. To create a name-to-object binding you invoke the `bind` method of a `Context` and specify a name and an object as arguments. The object can later be retrieved using its name using the `Context` lookup method. A `Context` will typically provide operations for binding a name to an object, unbinding a name, and obtaining a listing of all name-to-object bindings. The object you bind into a `Context` can itself be of type `Context`. The `Context` object that is bound is referred to as a subcontext of the `Context` on which the `bind` method was invoked.

As an example, consider a file directory with a pathname `/usr`, which is a context in the Unix file system. A file directory named relative to another file directory is a subcontext (commonly referred to as a subdirectory). A file directory with a pathname `/usr/jboss` names a `jboss` context that is a subcontext of `usr`. In another example, a DNS domain, such as `org`, is a context. A DNS domain named relative to another DNS domain is another example of a subcontext. In the DNS domain `jboss.org`, the DNS domain `jboss` is a subcontext of `org` because DNS names are parsed right to left.

### 9.1.2.1. Obtaining a Context using InitialContext

All naming service operations are performed on some implementation of the `Context` interface. Therefore, you need a way to obtain a `Context` for the naming service you are interested in using. The `javax.naming.InitialContext` class implements the `Context` interface, and provides the starting point for interacting with a naming service.

When you create an `InitialContext`, it is initialized with properties from the environment. JNDI determines each property's value by merging the values from the following two sources, in order.

- The first occurrence of the property from the constructor's environment parameter and (for appropriate properties) the applet parameters and system properties.
- All `jndi.properties` resource files found on the classpath.

For each property found in both of these two sources, the property's value is determined as follows. If the property is one of the standard JNDI properties that specify a list of JNDI factories, all of the values

are concatenated into a single colon-separated list. For other properties, only the first value found is used. The preferred method of specifying the JNDI environment properties is through a `jndi.properties` file, which allows your code to externalize the JNDI provider specific information so that changing JNDI providers will not require changes to your code or recompilation.

The `Context` implementation used internally by the `InitialContext` class is determined at runtime. The default policy uses the environment property `java.naming.factory.initial`, which contains the class name of the `javax.naming.spi.InitialContextFactory` implementation. You obtain the name of the `InitialContextFactory` class from the naming service provider you are using.

[Example 9.1, “A sample jndi.properties file”](#) gives a sample `jndi.properties` file a client application would use to connect to a JBossNS service running on the local host at port 1099. The client application would need to have the `jndi.properties` file available on the application classpath. These are the properties that the JBossNS JNDI implementation requires. Other JNDI providers will have different properties and values.

#### Example 9.1. A sample `jndi.properties` file

```
### JBossNS properties
java.naming.factory.initial=org.jnp.interfaces.NamingContextFactory
java.naming.provider.url=jnp://localhost:1099
java.naming.factory.url.pkgs=org.jboss.naming:org.jnp.interfaces
```

## 9.2. THE JBOSS NAMING SERVICE ARCHITECTURE

The JBoss Naming Service (JBossNS) architecture is a Java socket/RMI based implementation of the `javax.naming.Context` interface. It is a client/server implementation that can be accessed remotely. The implementation is optimized so that access from within the same VM in which the JBossNS server is running does not involve sockets. Same VM access occurs through an object reference available as a global singleton. [Figure 9.1, “Key components in the JBoss Naming Service architecture.”](#) illustrates some of the key classes in the JBossNS implementation and their relationships.

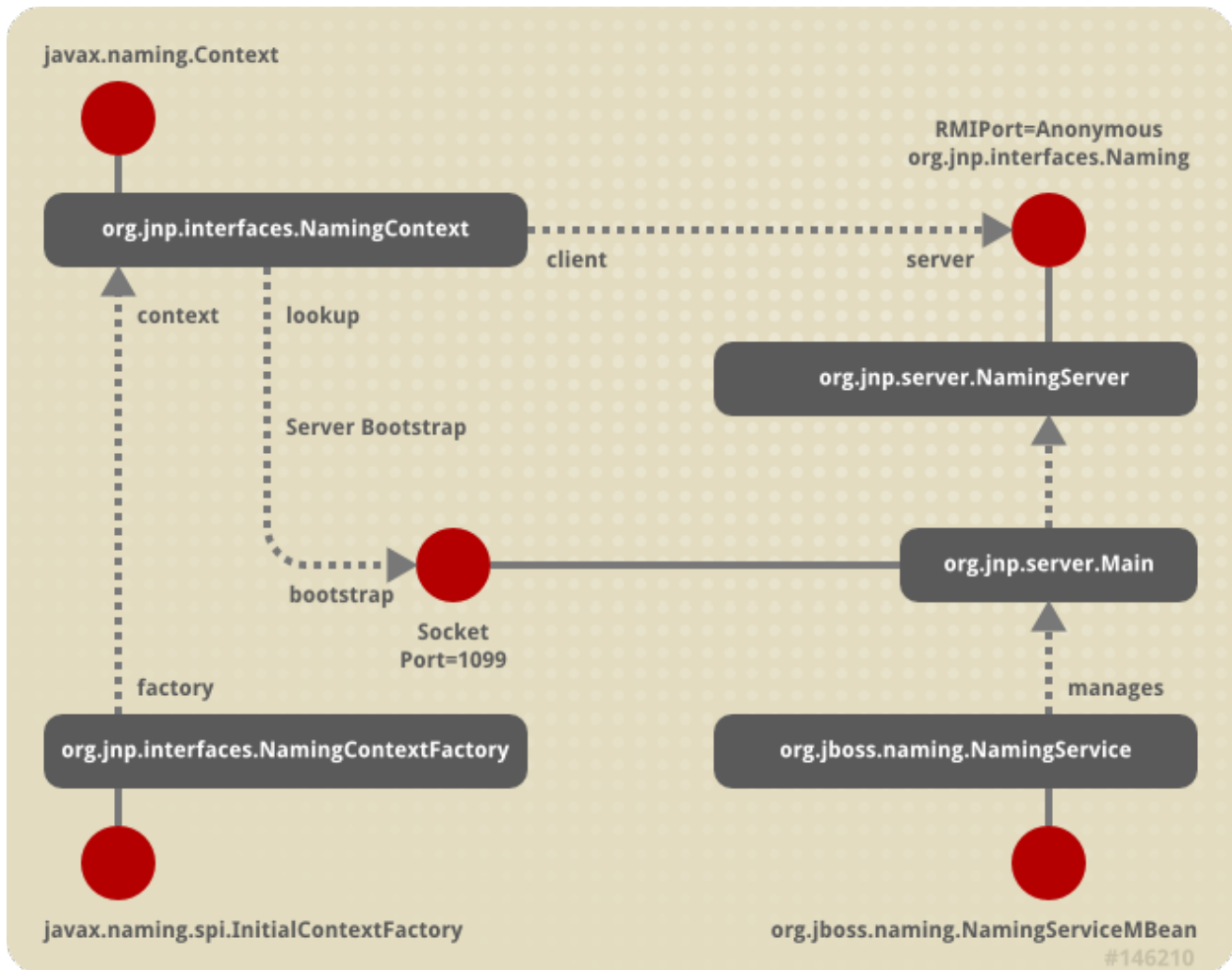

Figure 9.1. Key components in the JBoss Naming Service architecture.

We will start with the `NamingService` MBean. The `NamingService` MBean provides the JNDI naming service. This is a key service used pervasively by the J2EE technology components. The configurable attributes for the `NamingService` are as follows.

- **Port:** The jnp protocol listening port for the `NamingService`. If not specified default is 1099, the same as the RMI registry default port.
- **RmiPort:** The RMI port on which the RMI Naming implementation will be exported. If not specified the default is 0 which means use any available port.
- **BindAddress:** The specific address the `NamingService` listens on. This can be used on a multi-homed host for a `java.net.ServerSocket` that will only accept connect requests on one of its addresses.
- **RmiBindAddress:** The specific address the RMI server portion of the `NamingService` listens on. This can be used on a multi-homed host for a `java.net.ServerSocket` that will only accept connect requests on one of its addresses. If this is not specified and the `BindAddress` is, the `RmiBindAddress` defaults to the `BindAddress` value.
- **Backlog:** The maximum queue length for incoming connection indications (a request to connect) is set to the `backLog` parameter. If a connection indication arrives when the queue is full, the connection is refused.

- **ClientSocketFactory**: An optional custom `java.rmi.server.RMIClientSocketFactory` implementation class name. If not specified the default `RMIClientSocketFactory` is used.
- **ServerSocketFactory**: An optional custom `java.rmi.server.RMIServerSocketFactory` implementation class name. If not specified the default `RMIServerSocketFactory` is used.
- **JNPServerSocketFactory**: An optional custom `javax.net.ServerSocketFactory` implementation class name. This is the factory for the `ServerSocket` used to bootstrap the download of the JBoss Naming Service `Naming` interface. If not specified the `javax.net.ServerSocketFactory.getDefault()` method value is used.

The `NamingService` also creates the `java:comp` context such that access to this context is isolated based on the context class loader of the thread that accesses the `java:comp` context. This provides the application component private ENC that is required by the J2EE specs. This segregation is accomplished by binding a `javax.naming.Reference` to a context that uses the `org.jboss.naming.ENCFactory` as its `javax.naming.ObjectFactory`. When a client performs a lookup of `java:comp`, or any subcontext, the `ENCFactory` checks the thread context `ClassLoader`, and performs a lookup into a map using the `ClassLoader` as the key.

If a context instance does not exist for the class loader instance, one is created and associated with that class loader in the `ENCFactory` map. Thus, correct isolation of an application component's ENC relies on each component receiving a unique `ClassLoader` that is associated with the component threads of execution.

The `NamingService` delegates its functionality to an `org.jnp.server.Main` MBean. The reason for the duplicate MBeans is because JBoss Naming Service started out as a stand-alone JNDI implementation, and can still be run as such. The `NamingService` MBean embeds the `Main` instance into the server so that usage of JNDI with the same VM as the server does not incur any socket overhead. The configurable attributes of the `NamingService` are really the configurable attributes of the JBoss Naming Service `Main` MBean. The setting of any attributes on the `NamingService` MBean simply set the corresponding attributes on the `Main` MBean the `NamingService` contains. When the `NamingService` is started, it starts the contained `Main` MBean to activate the JNDI naming service.

In addition, the `NamingService` exposes the `Naming` interface operations through a JMX detyped invoke operation. This allows the naming service to be accessed via JMX adaptors for arbitrary protocols. We will look at an example of how HTTP can be used to access the naming service using the invoke operation later in this chapter.

When the `Main` MBean is started, it performs the following tasks:

- Instantiates an `org.jnp.naming.NamingService` instance and sets this as the local VM server instance. This is used by any `org.jnp.interfaces.NamingContext` instances that are created within the server VM to avoid RMI calls over TCP/IP.
- Exports the `NamingServer` instance's `org.jnp.interfaces.Naming` RMI interface using the configured `RmiPort`, `ClientSocketFactory`, `ServerSocketFactory` attributes.
- Creates a socket that listens on the interface given by the `BindAddress` and `Port` attributes.
- Spawns a thread to accept connections on the socket.

## 9.3. THE NAMING INITIALCONTEXT FACTORIES

The JBoss JNDI provider currently supports several different `InitialContext` factory implementations.

### 9.3.1. The standard naming context factory

The most commonly used factory is the `org.jnp.interfaces.NamingContextFactory` implementation. Its properties include:

- **java.naming.factory.initial:** The name of the environment property for specifying the initial context factory to use. The value of the property should be the fully qualified class name of the factory class that will create an initial context. If it is not specified, a `javax.naming.NoInitialContextException` will be thrown when an `InitialContext` object is created.
- **java.naming.provider.url:** The name of the environment property for specifying the location of the JBoss JNDI service provider the client will use. The `NamingContextFactory` class uses this information to know which JBossNS server to connect to. The value of the property should be a URL string. For JBossNS the URL format is `jnp://host:port/[jndi_path]`. The `jnp:` portion of the URL is the protocol and refers to the socket/RMI based protocol used by JBoss. The `jndi_path` portion of the URL is an optional JNDI name relative to the root context, for example, `apps` or `apps/tmp`. Everything but the host component is optional. The following examples are equivalent because the default port value is 1099.
  - `jnp://www.jboss.org:1099/`
  - `www.jboss.org:1099`
  - `www.jboss.org`
- **java.naming.factory.url.pkgs:** The name of the environment property for specifying the list of package prefixes to use when loading in URL context factories. The value of the property should be a colon-separated list of package prefixes for the class name of the factory class that will create a URL context factory. For the JBoss JNDI provider this must be `org.jboss.naming:org.jnp.interfaces`. This property is essential for locating the `jnp:` and `java:` URL context factories of the JBoss JNDI provider.
- **jnp.socketFactory:** The fully qualified class name of the `javax.net.SocketFactory` implementation to use to create the bootstrap socket. The default value is `org.jnp.interfaces.TimedSocketFactory`. The `TimedSocketFactory` is a simple `SocketFactory` implementation that supports the specification of a connection and read timeout. These two properties are specified by:
  - **jnp.timeout:** The connection timeout in milliseconds. The default value is 0 which means the connection will block until the VM TCP/IP layer times out.
  - **jnp.sotimeout:** The connected socket read timeout in milliseconds. The default value is 0 which means reads will block. This is the value passed to the `Socket.setSoTimeout` on the newly connected socket.

When a client creates an `InitialContext` with these JBossNS properties available, the `org.jnp.interfaces.NamingContextFactory` object is used to create the `Context` instance that will be used in subsequent operations. The `NamingContextFactory` is the JBossNS implementation of the `javax.naming.spi.InitialContextFactory` interface. When the `NamingContextFactory` class is asked to create a `Context`, it creates an `org.jnp.interfaces.NamingContext` instance with the `InitialContext` environment and

name of the context in the global JNDI namespace. It is the `NamingContext` instance that actually performs the task of connecting to the JBossNS server, and implements the `Context` interface. The `Context.PROVIDER_URL` information from the environment indicates from which server to obtain a `NamingServer` RMI reference.

The association of the `NamingContext` instance to a `NamingServer` instance is done in a lazy fashion on the first `Context` operation that is performed. When a `Context` operation is performed and the `NamingContext` has no `NamingServer` associated with it, it looks to see if its environment properties define a `Context.PROVIDER_URL`. A `Context.PROVIDER_URL` defines the host and port of the JBossNS server the `Context` is to use. If there is a provider URL, the `NamingContext` first checks to see if a `Naming` instance keyed by the host and port pair has already been created by checking a `NamingContext` class static map. It simply uses the existing `Naming` instance if one for the host port pair has already been obtained. If no `Naming` instance has been created for the given host and port, the `NamingContext` connects to the host and port using a `java.net.Socket`, and retrieves a `Naming` RMI stub from the server by reading a `java.rmi.MarshalledObject` from the socket and invoking its `get` method. The newly obtained `Naming` instance is cached in the `NamingContext` server map under the host and port pair. If no provider URL was specified in the JNDI environment associated with the context, the `NamingContext` simply uses the in VM `Naming` instance set by the `Main` MBean.

The `NamingContext` implementation of the `Context` interface delegates all operations to the `Naming` instance associated with the `NamingContext`. The `NamingServer` class that implements the `Naming` interface uses a `java.util.Hashtable` as the `Context` store. There is one unique `NamingServer` instance for each distinct JNDI Name for a given JBossNS server. There are zero or more transient `NamingContext` instances active at any given moment that refers to a `NamingServer` instance. The purpose of the `NamingContext` is to act as a `Context` to the `Naming` interface adaptor that manages translation of the JNDI names passed to the `NamingContext`. Because a JNDI name can be relative or a URL, it needs to be converted into an absolute name in the context of the JBossNS server to which it refers. This translation is a key function of the `NamingContext`.

### 9.3.2. The `org.jboss.naming.NamingContextFactory`

This version of the `InitialContextFactory` implementation is a simple extension of the `jnp` version which differs from the `jnp` version in that it stores the last configuration passed to its `InitialContextFactory.getInitialContext(Hashtable env)` method in a public thread local variable. This is used by EJB handles and other JNDI sensitive objects like the `UserTransaction` factory to keep track of the JNDI context that was in effect when they were created. If you want this environment to be bound to the object even after its serialized across vm boundaries, then you should use the `org.jboss.naming.NamingContextFactory`. If you want the environment that is defined in the current VM `jndi.properties` or system properties, then you should use the `org.jnp.interfaces.NamingContextFactory` version.

### 9.3.3. Naming Discovery in Clustered Environments

When running in a clustered JBoss environment, you can choose not to specify a `Context.PROVIDER_URL` value and let the client query the network for available naming services. This only works with servers running with the `all` server profile, or an equivalent server profile that has `org.jboss.ha.framework.server.ClusterPartition` and `org.jboss.ha.jndi.HANamingService` services deployed. The discovery process consists of sending a multicast request packet to the discovery address/port and waiting for any node to respond. The response is a HA-RMI version of the `Naming` interface. The following `InitialContext` properties affect the discovery configuration:

- **jnp.partitionName:** The cluster partition name discovery should be restricted to. If you are running in an environment with multiple clusters, you may want to restrict the naming discovery to a particular cluster. There is no default value, meaning that any cluster response will be accepted.
- **jnp.discoveryGroup:** The multicast IP/address to which the discovery query is sent. The default is 230.0.0.4.
- **jnp.discoveryPort:** The port to which the discovery query is sent. The default is 1102.
- **jnp.discoveryTimeout:** The time in milliseconds to wait for a discovery query response. The default value is 5000 (5 seconds).
- **jnp.disableDiscovery:** A flag indicating if the discovery process should be avoided. Discovery occurs when either no `Context.PROVIDER_URL` is specified, or no valid naming service could be located among the URLs specified. If the `jnp.disableDiscovery` flag is true, then discovery will not be attempted.

### 9.3.4. The HTTP InitialContext Factory Implementation

The JNDI naming service can be accessed over HTTP. From a JNDI client's perspective this is a transparent change as they continue to use the JNDI `Context` interface. Operations through the `Context` interface are translated into HTTP posts to a servlet that passes the request to the `NamingService` using its JMX invoke operation. Advantages of using HTTP as the access protocol include better access through firewalls and proxies setup to allow HTTP, as well as the ability to secure access to the JNDI service using standard servlet role based security.

To access JNDI over HTTP you use the `org.jboss.naming.HttpNamingContextFactory` as the factory implementation. The complete set of support `InitialContext` environment properties for this factory are:

- **java.naming.factory.initial:** The name of the environment property for specifying the initial context factory, which must be `org.jboss.naming.HttpNamingContextFactory`.
- **java.naming.provider.url (or Context.PROVIDER\_URL):** This must be set to the HTTP URL of the JNDI factory. The full HTTP URL would be the public URL of the JBoss servlet container plus `/invoker/JNDIFactory`. Examples include:
  - `http://www.jboss.org:8080/invoker/JNDIFactory`
  - `http://www.jboss.org/invoker/JNDIFactory`
  - `https://www.jboss.org/invoker/JNDIFactory`

The first example accesses the servlet using the port 8080. The second uses the standard HTTP port 80, and the third uses an SSL encrypted connection to the standard HTTPS port 443.

- **java.naming.factory.url.pkgs:** For all JBoss JNDI provider this must be `org.jboss.naming:org.jnp.interfaces`. This property is essential for locating the `jnp:` and `java:` URL context factories of the JBoss JNDI provider.

The JNDI `Context` implementation returned by the `HttpNamingContextFactory` is a proxy that delegates invocations made on it to a bridge servlet which forwards the invocation to the `NamingService` through the JMX bus and marshals the reply back over HTTP. The proxy needs to know what the URL of the bridge servlet is in order to operate. This value may have been bound on the

server side if the JBoss web server has a well known public interface. If the JBoss web server is sitting behind one or more firewalls or proxies, the proxy cannot know what URL is required. In this case, the proxy will be associated with a system property value that must be set in the client VM. For more information on the operation of JNDI over HTTP see [Section 9.4.1, “Accessing JNDI over HTTP”](#).



## NOTE

If a cluster partition uses the default partition name, the discovery process ignores other clusters. Therefore, make sure to specify unique partition names:  
`props.put("jnp.partitionName", "ClusterBPartition")` when using several clusters.

### 9.3.5. The Login InitialContext Factory Implementation

JAAS is the preferred method for authenticating a remote client to JBoss. However, for simplicity and to ease the migration from other application server environment that do not use JAAS, JBoss allows you the security credentials to be passed through the `InitialContext`. JAAS is still used under the covers, but there is no manifest use of the JAAS interfaces in the client application.

The factory class that provides this capability is the `org.jboss.security.jndi.LoginInitialContextFactory`. The complete set of support `InitialContext` environment properties for this factory are:

- `java.naming.factory.initial`: The name of the environment property for specifying the initial context factory, which must be `org.jboss.security.jndi.LoginInitialContextFactory`.
- `java.naming.provider.url`: This must be set to a `NamingContextFactory` provider URL. The `LoginInitialContext` is really just a wrapper around the `NamingContextFactory` that adds a JAAS login to the existing `NamingContextFactory` behavior.
- `java.naming.factory.url.pkgs`: For all JBoss JNDI provider this must be `org.jboss.naming:org.jnp.interfaces`. This property is essential for locating the `jnp:` and `java:` URL context factories of the JBoss JNDI provider.
- `java.naming.security.principal` (or `Context.SECURITY_PRINCIPAL`): The principal to authenticate. This may be either a `java.security.Principal` implementation or a string representing the name of a principal.
- `java.naming.security.credentials` (or `Context.SECURITY_CREDENTIALS`), The credentials that should be used to authenticate the principal, e.g., password, session key, etc.
- `java.naming.security.protocol`: (`Context.SECURITY_PROTOCOL`) This gives the name of the JAAS login module to use for the authentication of the principal and credentials.

### 9.3.6. The ORBInitialContextFactory

When using Sun's CosNaming it is necessary to use a different naming context factory from the default. CosNaming looks for the ORB in JNDI instead of using the ORB configured in `deploy/iiop-service.xml?`. It is necessary to set the global context factory to `org.jboss.iiop.naming.ORBInitialContextFactory`, which sets the ORB to JBoss's ORB. This is done in the `conf/jndi.properties` file:

```
# DO NOT EDIT THIS FILE UNLESS YOU KNOW WHAT YOU ARE DOING
#
```



```
java.naming.factory.initial=org.jboss.iiop.naming.ORBInitialContextFactory
java.naming.factory.url.pkgs=org.jboss.naming:org.jnp.interfaces
```

It is also necessary to use **ORBInitialContextFactory** when using **CosNaming** in an application client.

## 9.4. JNDI OVER HTTP

In addition to the legacy RMI/JRMP with a socket bootstrap protocol, JBoss provides support for accessing its JNDI naming service over HTTP.

### 9.4.1. Accessing JNDI over HTTP

This capability is provided by `http-invoker.sar`. The structure of the `http-invoker.sar` is:

```

http-invoker.sar
├── invoker.war
│   ├── WEB-INF
│   │   ├── classes
│   │   │   ├── org
│   │   │   │   ├── jboss
│   │   │   │   │   ├── invocation
│   │   │   │   │   │   ├── http
│   │   │   │   │   │   │   ├── servlet
│   │   │   │   │   │   │   │   ├── InvokerServlet.class
│   │   │   │   │   │   │   │   └──
│   │   │   │   │   │   └──
│   │   │   │   │   └──
│   │   │   │   └──
│   │   │   └──
│   │   └──
│   │       ├── InvokerServlet$GetCredentialAction.class
│   │       ├── InvokerServlet$GetPrincipalAction.class
│   │       ├── NamingFactoryServlet.class
│   │       └── ReadOnlyAccessFilter.class
│   ├── jboss-web.xml
│   └── web.xml
└── META-INF
    └── jboss-service.xml

```

The `jboss-service.xml` descriptor defines the **HttpInvoker** and **HttpInvokerHA** MBeans. These services handle the routing of methods invocations that are sent via HTTP to the appropriate target MBean on the JMX bus.

The `http-invoker.war` web application contains servlets that handle the details of the HTTP transport. The **NamingFactoryServlet** handles creation requests for the JBoss JNDI naming service `javax.naming.Context` implementation. The **InvokerServlet** handles invocations made by RMI/HTTP clients. The **ReadOnlyAccessFilter** allows one to secure the JNDI naming service while making a single JNDI context available for read-only access by unauthenticated clients.

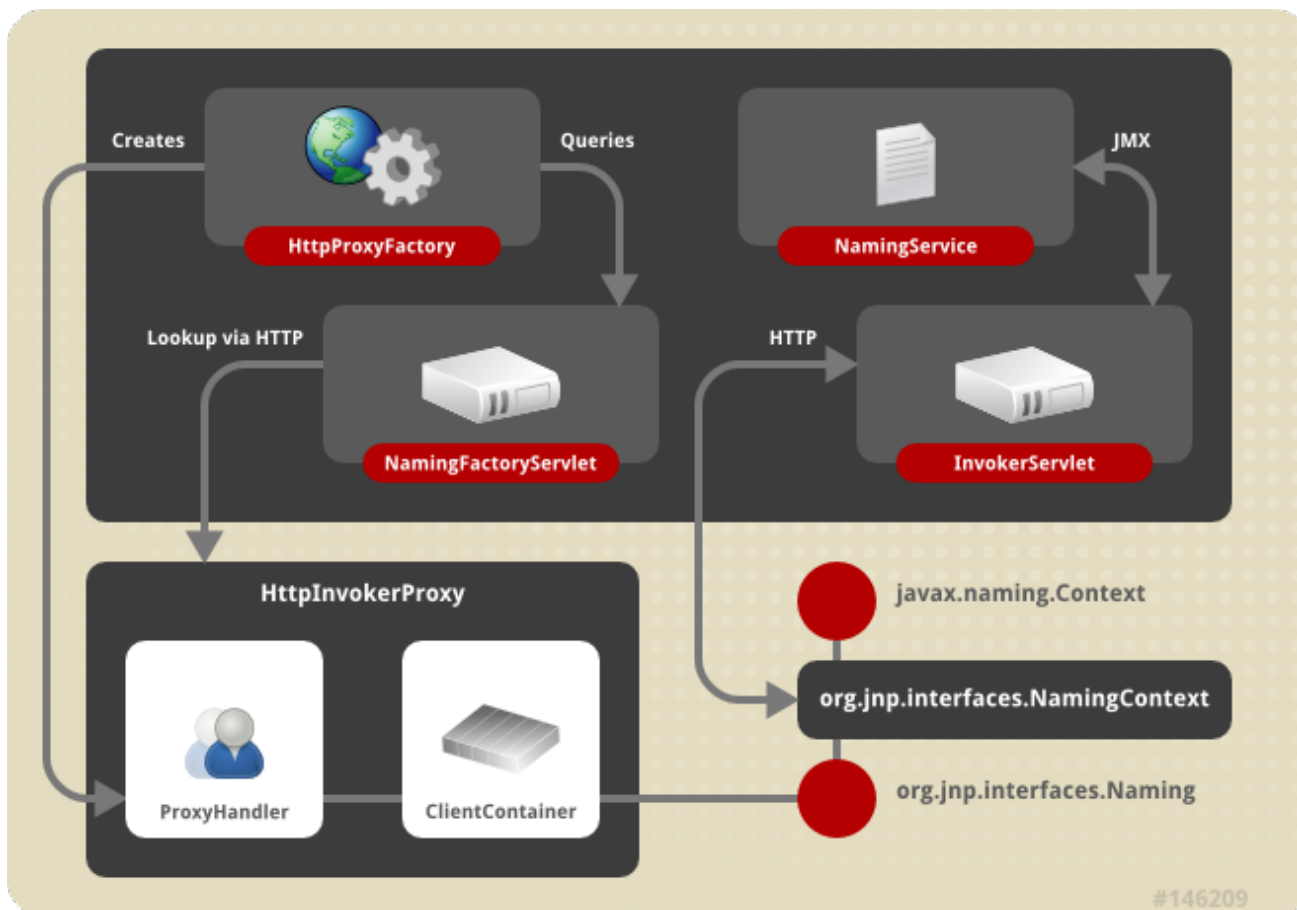

Figure 9.2. The HTTP invoker proxy/server structure for a JNDI Context

Before looking at the configurations let us look at the operation of the `http-invoker` services. Figure 9.2, “The HTTP invoker proxy/server structure for a JNDI Context” shows a logical view of the structure of a JBoss JNDI proxy and its relationship to the server side components of the `http-invoker`. The proxy is obtained from the `NamingFactoryServlet` using an `InitialContext` with the `Context.INITIAL_CONTEXT_FACTORY` property set to `org.jboss.naming.HttpNamingContextFactory`, and the `Context.PROVIDER_URL` property set to the HTTP URL of the `NamingFactoryServlet`. The resulting proxy is embedded in an `org.jnp.interfaces.NamingContext` instance that provides the `Context` interface implementation.

The proxy is an instance of `org.jboss.invocation.http.interfaces.HttpInvokerProxy`, and implements the `org.jnp.interfaces.Naming` interface. Internally the `HttpInvokerProxy` contains an invoker that marshals the `Naming` interface method invocations to the `InvokerServlet` via HTTP posts. The `InvokerServlet` translates these posts into JMX invocations to the `NamingService`, and returns the invocation response back to the proxy in the HTTP post response.

There are several configuration values that need to be set to tie all of these components together and Figure 9.3, “The relationship between configuration files and JNDI/HTTP component” illustrates the relationship between configuration files and the corresponding components.

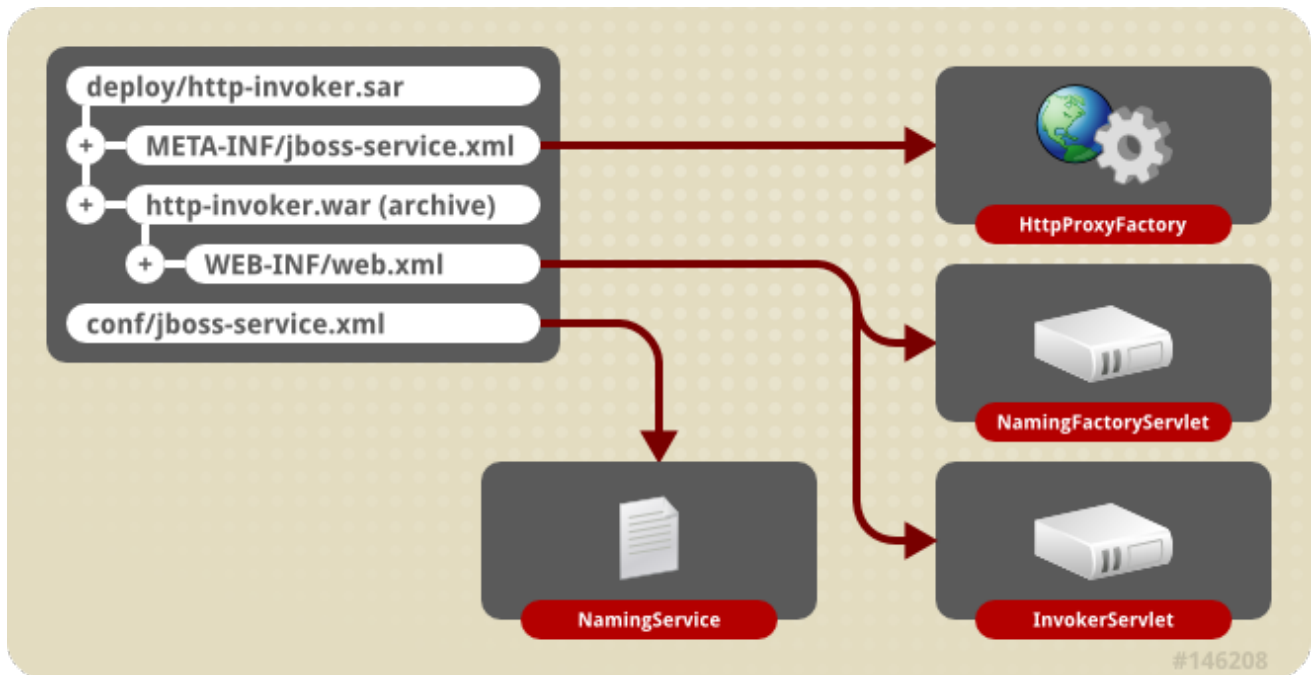

Figure 9.3. The relationship between configuration files and JNDI/HTTP component

The `http-invoker.sar/META-INF/jboss-service.xml` descriptor defines the `HttpProxyFactory` that creates the `HttpInvokerProxy` for the `NamingService`. The attributes that need to be configured for the `HttpProxyFactory` include:

- **InvokerName:** The JMX `ObjectName` of the `NamingService` defined in the `conf/jboss-service.xml` descriptor. The standard setting used in the JBoss distributions is `jboss:service=Naming`.
- **InvokerURL or InvokerURLPrefix + InvokerURLSuffix + UseHostName.** You can specify the full HTTP URL to the `InvokerServlet` using the `InvokerURL` attribute, or you can specify the hostname independent parts of the URL and have the `HttpProxyFactory` fill them in. An example `InvokerURL` value would be `http://jboss-host1.dot.com:8080/invoker/JMXInvokerServlet`. This can be broken down into:
  - **InvokerURLPrefix:** the URL prefix prior to the hostname. Typically this will be `http://` or `https://` if SSL is to be used.
  - **InvokerURLSuffix:** the URL suffix after the hostname. This will include the port number of the web server as well as the deployed path to the `InvokerServlet`. For the example `InvokerURL` value the `InvokerURLSuffix` would be `:8080/invoker/JMXInvokerServlet` without the quotes. The port number is determined by the web container service settings. The path to the `InvokerServlet` is specified in the `http-invoker.sar/invoker.war/WEB-INF/web.xml` descriptor.
  - **UseHostName:** a flag indicating if the hostname should be used in place of the host IP address when building the hostname portion of the full `InvokerURL`. If true, `InetAddress.getLocalHost().getHostName` method will be used. Otherwise, the `InetAddress.getLocalHost().getHostAddress()` method is used.
- **ExportedInterface:** The `org.jnp.interfaces.Naming` interface the proxy will expose to clients. The actual client of this proxy is the JBoss JNDI implementation `NamingContext` class, which JNDI client obtain from `InitialContext` lookups when using the JBoss JNDI provider.

- **JndiName:** The name in JNDI under which the proxy is bound. This needs to be set to a blank/empty string to indicate the interface should not be bound into JNDI. We can not use the JNDI to bootstrap itself. This is the role of the **NamingFactoryServlet**.

The `http-invoker.sar/invoker.war/WEB-INF/web.xml` descriptor defines the mappings of the **NamingFactoryServlet** and **InvokerServlet** along with their initialization parameters. The configuration of the **NamingFactoryServlet** relevant to JNDI/HTTP is the **JNDIFactory** entry which defines:

- A **namingProxyMBean** initialization parameter that maps to the **HttpProxyFactory** MBean name. This is used by the **NamingFactoryServlet** to obtain the **Naming** proxy which it will return in response to HTTP posts. For the default `http-invoker.sar/META-INF/jboss-service.xml` settings the name `jboss:service=invoker,type=http,target=Naming`.
- A proxy initialization parameter that defines the name of the **namingProxyMBean** attribute to query for the **Naming** proxy value. This defaults to an attribute name of **Proxy**.
- The servlet mapping for the **JNDIFactory** configuration. The default setting for the unsecured mapping is `/JNDIFactory/*`. This is relative to the context root of the `http-invoker.sar/invoker.war`, which by default is the WAR name minus the `.war` suffix.

The configuration of the **InvokerServlet** relevant to JNDI/HTTP is the **JMXInvokerServlet** which defines:

- The servlet mapping of the **InvokerServlet**. The default setting for the unsecured mapping is `/JMXInvokerServlet/*`. This is relative to the context root of the `http-invoker.sar/invoker.war`, which by default is the WAR name minus the `.war` suffix.

## 9.4.2. Accessing JNDI over HTTPS

To be able to access JNDI over HTTP/SSL you need to enable an SSL connector on the web container. The details of this are covered in the Integrating Servlet Containers for Tomcat. We will demonstrate the use of HTTPS with a simple example client that uses an HTTPS URL as the JNDI provider URL. We will provide an SSL connector configuration for the example, so unless you are interested in the details of the SSL connector setup, the example is self contained.

We also provide a configuration of the **HttpProxyFactory** setup to use an HTTPS URL. The following example shows the section of the `http-invoker.sar/jboss-service.xml` descriptor that the example installs to provide this configuration. All that has changed relative to the standard HTTP configuration are the **InvokerURLPrefix** and **InvokerURLSuffix** attributes, which setup an HTTPS URL using the 8443 port.

```
<!-- Expose the Naming service interface via HTTPS -->
<mbean code="org.jboss.invocation.http.server.HttpProxyFactory"
  name="jboss:service=invoker,type=https,target=Naming">
  <!-- The Naming service we are proxying -->
  <attribute name="InvokerName">jboss:service=Naming</attribute>
  <!-- Compose the invoker URL from the cluster node address -->
  <attribute name="InvokerURLPrefix">https://</attribute>
  <attribute name="InvokerURLSuffix">:8443/invoker/JMXInvokerServlet
</attribute>
  <attribute name="UseHostName">>true</attribute>
  <attribute name="ExportedInterface">org.jnp.interfaces.Naming
</attribute>
  <attribute name="JndiName"/>
```

```

    <attribute name="ClientInterceptors">
        <interceptors>
            <interceptor>org.jboss.proxy.ClientMethodInterceptor
        </interceptor>
            <interceptor>org.jboss.proxy.SecurityInterceptor
        </interceptor>

        <interceptor>org.jboss.naming.interceptors.ExceptionInterceptor
        </interceptor>
            <interceptor>org.jboss.invocation.InvokerInterceptor
        </interceptor>
        </interceptors>
    </attribute>
</mbean>

```

At a minimum, a JNDI client using HTTPS requires setting up a HTTPS URL protocol handler. We will be using the Java Secure Socket Extension (JSSE) for HTTPS. The JSSE documentation does a good job of describing what is necessary to use HTTPS, and the following steps were needed to configure the example client shown in [Example 9.2, “A JNDI client that uses HTTPS as the transport”](#) :

- A protocol handler for HTTPS URLs must be made available to Java. The JSSE release includes an HTTPS handler in the `com.sun.net.ssl.internal.www.protocol` package. To enable the use of HTTPS URLs you include this package in the standard URL protocol handler search property, `java.protocol.handler.pkgs`. We set the `java.protocol.handler.pkgs` property in the Ant script.
- The JSSE security provider must be installed in order for SSL to work. This can be done either by installing the JSSE jars as an extension package, or programmatically. We use the programmatic approach in the example since this is less intrusive. Line 18 of the `ExClient` code demonstrates how this is done.
- The JNDI provider URL must use HTTPS as the protocol. Lines 24-25 of the `ExClient` code specify an HTTP/SSL connection to the localhost on port 8443. The hostname and port are defined by the web container SSL connector.
- The validation of the HTTPS URL hostname against the server certificate must be disabled. By default, the JSSE HTTPS protocol handler employs a strict validation of the hostname portion of the HTTPS URL against the common name of the server certificate. This is the same check done by web browsers when you connect to secured web site. We are using a self-signed server certificate that uses a common name of "Chapter 8 SSL Example" rather than a particular hostname, and this is likely to be common in development environments or intranets. The `JBoss HttpInvokerProxy` will override the default hostname checking if a `org.jboss.security.ignoreHttpsHost` system property exists and has a value of true. We set the `org.jboss.security.ignoreHttpsHost` property to true in the Ant script.

### Example 9.2. A JNDI client that uses HTTPS as the transport

```

package org.jboss.chap3.ex1;

import java.security.Security;
import java.util.Properties;
import javax.naming.Context;
import javax.naming.InitialContext;

public class ExClient

```

```

{
    public static void main(String args[]) throws Exception
    {
        Properties env = new Properties();
        env.setProperty(Context.INITIAL_CONTEXT_FACTORY,
            "org.jboss.naming.HttpNamingContextFactory");
        env.setProperty(Context.PROVIDER_URL,
            "https://localhost:8443/invoker/JNDIFactorySSL");

        Context ctx = new InitialContext(env);
        System.out.println("Created InitialContext, env=" + env);

        Object data = ctx.lookup("jmx/invoker/RMIAdaptor");
        System.out.println("lookup(jmx/invoker/RMIAdaptor): " + data);
    }
}

```

To test the client, first build the chapter 3 example to create the `chap3` configuration fileset.

```
[examples]$ ant -Dchap=naming config
```

Next, start the server using the `naming` configuration fileset:

```
[bin]$ sh run.sh -c naming
```

And finally, run the `ExClient` using:

```

[examples]$ ant -Dchap=naming -Dex=1 run-example
...
run-example1:

[java] Created InitialContext, env={java.naming. \
provider.url=https://localhost:8443/invoker/JNDIFactorySSL, java.naming. \
factory.initial=org.jboss.naming.HttpNamingContextFactory}
    [java] lookup(jmx/invoker/RMIAdaptor): org.jboss.invocation.jrmp. \
    interfaces.JRMPInvokerP
roxy@cac3fa

```

### 9.4.3. Securing Access to JNDI over HTTP

One benefit to accessing JNDI over HTTP is that it is easy to secure access to the JNDI `InitialContext` factory as well as the naming operations using standard web declarative security. This is possible because the server side handling of the JNDI/HTTP transport is implemented with two servlets. These servlets are included in the `http-invoker.sar/invoker.war` directory found in the `default` and `all` server profile deploy directories as shown previously. To enable secured access to JNDI you need to edit the `invoker.war/WEB-INF/web.xml` descriptor and remove all unsecured servlet mappings. For example, the `web.xml` descriptor shown in [Example 9.3, “An example web.xml descriptor for secured access to the JNDI servlets”](#) only allows access to the `invoker.war` servlets if the user has been authenticated and has a role of `HttpInvoker`.

**Example 9.3. An example web.xml descriptor for secured access to the JNDI servlets**

```

<?xml version="1.0" encoding="UTF-8"?>
<!DOCTYPE web-app PUBLIC
    "-//Sun Microsystems, Inc.//DTD Web Application 2.3//EN"
    "http://java.sun.com/dtd/web-app_2_3.dtd">
<web-app>
  <!-- ### Servlets -->
  <servlet>
    <servlet-name>JMXInvokerServlet</servlet-name>
    <servlet-class>
      org.jboss.invocation.http.servlet.InvokerServlet
    </servlet-class>
    <load-on-startup>1</load-on-startup>
  </servlet>
  <servlet>
    <servlet-name>JNDIFactory</servlet-name>
    <servlet-class>
      org.jboss.invocation.http.servlet.NamingFactoryServlet
    </servlet-class>
    <init-param>
      <param-name>namingProxyMBean</param-name>
      <param-
value>jboss:service=invoker,type=http,target=Naming</param-value>
    </init-param>
    <init-param>
      <param-name>proxyAttribute</param-name>
      <param-value>Proxy</param-value>
    </init-param>
    <load-on-startup>2</load-on-startup>
  </servlet>
  <!-- ### Servlet Mappings -->
  <servlet-mapping>
    <servlet-name>JNDIFactory</servlet-name>
    <url-pattern>/restricted/JNDIFactory/*</url-pattern>
  </servlet-mapping>
  <servlet-mapping>
    <servlet-name>JMXInvokerServlet</servlet-name>
    <url-pattern>/restricted/JMXInvokerServlet/*</url-pattern>
  </servlet-mapping>
  <security-constraint>
    <web-resource-collection>
      <web-resource-name>HttpInvokers</web-resource-name>
      <description>An example security config that only allows
users with
      the role HttpInvoker to access the HTTP invoker
servlets </description>
    <url-pattern>/restricted/*</url-pattern>
    <http-method>GET</http-method>
    <http-method>POST</http-method>
    </web-resource-collection>
    <auth-constraint>
      <role-name>HttpInvoker</role-name>
    </auth-constraint>
  </security-constraint>
  <login-config>
    <auth-method>BASIC</auth-method>
    <realm-name>JBoss HTTP Invoker</realm-name>
  </login-config>
  <security-role>

```

```

        <role-name>HttpInvoker</role-name>
    </security-role>
</web-app>

```

The `web.xml` descriptor only defines which servlets are secured, and which roles are allowed to access the secured servlets. You must additionally define the security domain that will handle the authentication and authorization for the war. This is done through the `jboss-web.xml` descriptor, and an example that uses the `http-invoker` security domain is given below.

```

<jboss-web>
    <security-domain>java:/jaas/http-invoker</security-domain>
</jboss-web>

```

The `security-domain` element defines the name of the security domain that will be used for the JAAS login module configuration used for authentication and authorization.

#### 9.4.4. Securing Access to JNDI with a Read-Only Unsecured Context

Another feature available for the JNDI/HTTP naming service is the ability to define a context that can be accessed by unauthenticated users in read-only mode. This can be important for services used by the authentication layer. For example, the `SRPLoginModule` needs to lookup the SRP server interface used to perform authentication. The rest of this section explains how read-only works in JBoss Enterprise Application Platform.

First, the `ReadOnlyJNDIFactory` is declared in `invoker.sar/WEB-INF/web.xml`. It will be mapped to `/invoker/ReadOnlyJNDIFactory`.

```

<servlet>
    <servlet-name>ReadOnlyJNDIFactory</servlet-name>
    <description>A servlet that exposes the JBoss JNDI Naming service stub
        through http, but only for a single read-only context. The
return content
        is serialized MarshalledValue containing the
org.jnp.interfaces.Naming
        stub.
    </description>
    <servlet-
class>org.jboss.invocation.http.servlet.NamingFactoryServlet</servlet-
class>
    <init-param>
        <param-name>namingProxyMBean</param-name>
        <param-
value>jboss:service=invoker,type=http,target=Naming,readonly=true</param-
value>
    </init-param>
    <init-param>
        <param-name>proxyAttribute</param-name>
        <param-value>Proxy</param-value>
    </init-param>
    <load-on-startup>2</load-on-startup>
</servlet>

<!-- ... -->

```



```

<servlet-mapping>
  <servlet-name>ReadOnlyJNDIFactory</servlet-name>
  <url-pattern>/ReadOnlyJNDIFactory/*</url-pattern>
</servlet-mapping>

```

The factory only provides a JNDI stub which needs to be connected to an invoker. Here the invoker is `jboss:service=invoker, type=http, target=Naming, readonly=true`. This invoker is declared in the `http-invoker.sar/META-INF/jboss-service.xml` file.

```

  <mbean code="org.jboss.invocation.http.server.HttpProxyFactory"
    name="jboss:service=invoker,type=http,target=Naming,readonly=true">
    <attribute name="InvokerName">jboss:service=Naming</attribute>
    <attribute name="InvokerURLPrefix">http://</attribute>
    <attribute
name="InvokerURLSuffix">:8080/invoker/readonly/JMXInvokerServlet</attribut
e>
    <attribute name="UseHostName">true</attribute>
    <attribute
name="ExportedInterface">org.jnp.interfaces.Naming</attribute>
    <attribute name="JndiName"></attribute>
    <attribute name="ClientInterceptors">
      <interceptors>
<interceptor>org.jboss.proxy.ClientMethodInterceptor</interceptor>
<interceptor>org.jboss.proxy.SecurityInterceptor</interceptor>
<interceptor>org.jboss.naming.interceptors.ExceptionInterceptor</intercept
or>
<interceptor>org.jboss.invocation.InvokerInterceptor</interceptor>
      </interceptors>
    </attribute>
  </mbean>

```

The proxy on the client side needs to talk back to a specific invoker servlet on the server side. The configuration here has the actual invocations going to `/invoker/readonly/JMXInvokerServlet`. This is actually the standard `JMXInvokerServlet` with a read-only filter attached.

```

  <filter>
    <filter-name>ReadOnlyAccessFilter</filter-name>
    <filter-
class>org.jboss.invocation.http.servlet.ReadOnlyAccessFilter</filter-
class>
    <init-param>
      <param-name>readOnlyContext</param-name>
      <param-value>readonly</param-value>
      <description>The top level JNDI context the filter will enforce
operations
read-only access on. If specified only Context.lookup
will be allowed on this context. Another other operations or
lookups on any other context will fail. Do not associate
this
filter with the JMXInvokerServlets if you want unrestricted

```

```

        access. </description>
    </init-param>
    <init-param>
        <param-name>invokerName</param-name>
        <param-value>jboss:service=Naming</param-value>
        <description>The JMX ObjectName of the naming service mbean
    </description>
    </init-param>
</filter>

<filter-mapping>
    <filter-name>ReadOnlyAccessFilter</filter-name>
    <url-pattern>/readonly/*</url-pattern>
</filter-mapping>

<!-- ... -->
<!-- A mapping for the JMXInvokerServlet that only allows invocations
      of lookups under a read-only context. This is enforced by the
      ReadOnlyAccessFilter
      -->
<servlet-mapping>
    <servlet-name>JMXInvokerServlet</servlet-name>
    <url-pattern>/readonly/JMXInvokerServlet/*</url-pattern>
</servlet-mapping>

```

The `readOnlyContext` parameter is set to `readonly` which means that when you access JBoss through the `ReadOnlyJNDIFactory`, you will only be able to access data in the `readonly` context. Here is a code fragment that illustrates the usage:

```

Properties env = new Properties();
env.setProperty(Context.INITIAL_CONTEXT_FACTORY,
               "org.jboss.naming.HttpNamingContextFactory");
env.setProperty(Context.PROVIDER_URL,
               "http://localhost:8080/invoker/ReadOnlyJNDIFactory");

Context ctx2 = new InitialContext(env);
Object data = ctx2.lookup("readonly/data");

```

Attempts to look up any objects outside of the `readonly` context will fail. Note that JBoss does not ship with any data in the `readonly` context, so the `readonly` context will not be bound usable unless you create it.

## 9.5. ADDITIONAL NAMING MBEANS

In addition to the `NamingService` MBean that configures an embedded JBossNS server within JBoss, there are several additional MBean services related to naming that ship with JBoss. They are `JndiBindingServiceMgr`, `NamingAlias`, `ExternalContext`, and `JNDIView`.

### 9.5.1. JNDI Binding Manager

The JNDI binding manager service allows you to quickly bind objects into JNDI for use by application code. The MBean class for the binding service is `org.jboss.naming.JNDIBindingServiceMgr`. It has a single attribute, `BindingsConfig`, which accepts an XML document that conforms to the `jndi-`

`binding-service_1_0.xsd` schema. The content of the `BindingsConfig` attribute is unmarshaled using the JBossXB framework. The following is an MBean definition that shows the most basic form usage of the JNDI binding manager service.

```
<mbean code="org.jboss.naming.JNDIBindingServiceMgr"
      name="jboss.tests:name=example1">
  <attribute name="BindingsConfig" serialDataType="jbx" >
    <jndi:bindings xmlns:xs="http://www.w3.org/2001/XMLSchema-
instance"
                  xmlns:jndi="urn:jboss:jndi-binding-service:1.0"
                  xs:schemaLocation="urn:jboss:jndi-binding-service
\
      resource:jndi-binding-service_1_0.xsd">
      <jndi:binding name="bindexample/message">
        <jndi:value trim="true">
          Hello, JNDI!
        </jndi:value>
      </jndi:binding>
    </jndi:bindings>
  </attribute>
</mbean>
```

This binds the text string `"Hello, JNDI!"` under the JNDI name `bindexample/message`. An application would look up the value just as it would for any other JNDI value. The `trim` attribute specifies that leading and trailing whitespace should be ignored. The use of the attribute here is purely for illustrative purposes as the default value is `true`.

```
InitialContext ctx = new InitialContext();
String          text = (String) ctx.lookup("bindexample/message");
```

String values themselves are not that interesting. If a JavaBeans property editor is available, the desired class name can be specified using the `type` attribute

```
<jndi:binding name="urls/jboss-home">
  <jndi:value type="java.net.URL">http://www.jboss.org</jndi:value>
</jndi:binding>
```

The `editor` attribute can be used to specify a particular property editor to use.

```
<jndi:binding name="hosts/localhost">
  <jndi:value editor="org.jboss.util.propertyeditor.InetAddressEditor">
    127.0.0.1
  </jndi:value>
</jndi:binding>
```

For more complicated structures, any JBossXB-ready schema may be used. The following example shows how a `java.util.Properties` object would be mapped.

```
<jndi:binding name="maps/testProps">
  <java:properties xmlns:java="urn:jboss:java-properties"
                  xmlns:xs="http://www.w3.org/2001/XMLSchema-instance"
                  xs:schemaLocation="urn:jboss:java-properties \
resource:java-properties_1_0.xsd">
    <java:property>
```

```

        <java:key>key1</java:key>
        <java:value>value1</java:value>
    </java:property>
    <java:property>
        <java:key>key2</java:key>
        <java:value>value2</java:value>
    </java:property>
</java:properties>
</jndi:binding>

```

### 9.5.2. The `org.jboss.naming.NamingAlias` MBean

The `NamingAlias` MBean is a simple utility service that allows you to create an alias in the form of a JNDI `javax.naming.LinkRef` from one JNDI name to another. This is similar to a symbolic link in the Unix file system. To an alias you add a configuration of the `NamingAlias` MBean to the `jboss-service.xml` configuration file. The configurable attributes of the `NamingAlias` service are as follows:

- **FromName:** The location where the `LinkRef` is bound under JNDI.
- **ToName:** The to name of the alias. This is the target name to which the `LinkRef` refers. The name is a URL, or a name to be resolved relative to the `InitialContext`, or if the first character of the name is a dot (.), the name is relative to the context in which the link is bound.

The following example provides a mapping of the JNDI name `QueueConnectionFactory` to the name `ConnectionFactory`.

```

<mbean code="org.jboss.naming.NamingAlias"
name="jboss.mq:service=NamingAlias,fromName=QueueConnectionFactory">
    <attribute name="ToName">ConnectionFactory</attribute>
    <attribute name="FromName">QueueConnectionFactory</attribute>
</mbean>

```

### 9.5.3. `org.jboss.naming.ExternalContext` MBean

The `ExternalContext` MBean allows you to federate external JNDI contexts into the server JNDI namespace. The term external refers to any naming service external to the JBossNS naming service running inside of the server VM. You can incorporate LDAP servers, file systems, DNS servers, and so on, even if the JNDI provider root context is not serializable. The federation can be made available to remote clients if the naming service supports remote access.

To incorporate an external JNDI naming service, you have to add a configuration of the `ExternalContext` MBean service to the `jboss-service.xml` configuration file. The configurable attributes of the `ExternalContext` service are as follows:

- **JndiName:** The JNDI name under which the external context is to be bound.
- **RemoteAccess:** A boolean flag indicating if the external `InitialContext` should be bound using a `Serializable` form that allows a remote client to create the external `InitialContext`. When a remote client looks up the external context via the JBoss JNDI `InitialContext`, they effectively create an instance of the external `InitialContext` using the same env properties passed to the `ExternalContext` MBean. This will only work if the client can do a new `InitialContext(env)` remotely. This requires that the

`Context.PROVIDER_URL` value of env is resolvable in the remote VM that is accessing the context. This should work for the LDAP example. For the file system example this most likely will not work unless the file system path refers to a common network path. If this property is not given it defaults to false.

- **CacheContext:** The `cacheContext` flag. When set to true, the external `Context` is only created when the MBean is started and then stored as an in memory object until the MBean is stopped. If `cacheContext` is set to false, the external `Context` is created on each lookup using the MBean properties and `InitialContext` class. When the uncached `Context` is looked up by a client, the client should invoke `close()` on the `Context` to prevent resource leaks.
- **InitialContext:** The fully qualified class name of the `InitialContext` implementation to use. Must be one of: `javax.naming.InitialContext`, `javax.naming.directory.InitialDirContext` or `javax.naming.ldap.InitialLdapContext`. In the case of the `InitialLdapContext` a null `Controls` array is used. The default is `javax.naming.InitialContext`.
- **Properties:** The `Properties` attribute contains the JNDI properties for the external `InitialContext`. The input should be the text equivalent to what would go into a `jndi.properties` file.
- **PropertiesURL:** This set the `jndi.properties` information for the external `InitialContext` from an external properties file. This is either a URL, string or a classpath resource name. Examples are as follows:
  - `file:///config/myldap.properties`
  - `http://config.mycompany.com/myldap.properties`
  - `/conf/myldap.properties`
  - `myldap.properties`

The MBean definition below shows a binding to an external LDAP context into the JBoss JNDI namespace under the name `external/ldap/jboss`.

```
<!-- Bind a remote LDAP server -->
<mbean code="org.jboss.naming.ExternalContext"
name="jboss.jndi:service=ExternalContext,jndiName=external/ldap/jboss">
  <attribute name="JndiName">external/ldap/jboss</attribute>
  <attribute name="Properties">
    java.naming.factory.initial=com.sun.jndi.ldap.LdapCtxFactory
    java.naming.provider.url=ldap://ldaphost.jboss.org:389/o=jboss.org
    java.naming.security.principal=cn=Directory Manager
    java.naming.security.authentication=simple
    java.naming.security.credentials=secret
  </attribute>
  <attribute name="InitialContext"> javax.naming.ldap.InitialLdapContext
</attribute>
  <attribute name="RemoteAccess">true</attribute>
</mbean>
```

With this configuration, you can access the external LDAP context located at `ldap://ldaphost.jboss.org:389/o=jboss.org` from within the JBoss VM using the following code fragment:

```
InitialContext iniCtx = new InitialContext();
LdapContext ldapCtx = iniCtx.lookup("external/ldap/jboss");
```

Using the same code fragment outside of the server VM will work in this case because the `RemoteAccess` property was set to true. If it were set to false, it would not work because the remote client would receive a `Reference` object with an `ObjectFactory` that would not be able to recreate the external `InitialContext`.

```
<!-- Bind the /usr/local file system directory -->
<mbean code="org.jboss.naming.ExternalContext"

name="jboss.jndi:service=ExternalContext,jndiName=external/fs/usr/local">
  <attribute name="JndiName">external/fs/usr/local</attribute>
  <attribute name="Properties">

java.naming.factory.initial=com.sun.jndi.fscontext.RefFSContextFactory
  java.naming.provider.url=file:///usr/local
  </attribute>
  <attribute
name="InitialContext">javax.naming.InitialContext</attribute>
</mbean>
```

This configuration describes binding a local file system directory `/usr/local` into the JBoss JNDI namespace under the name `external/fs/usr/local`.

With this configuration, you can access the external file system context located at `file:///usr/local` from within the JBoss VM using the following code fragment:

```
InitialContext iniCtx = new InitialContext();
Context ldapCtx = iniCtx.lookup("external/fs/usr/local");
```

#### 9.5.4. The `org.jboss.naming.JNDIView` MBean

The `JNDIView` MBean allows the user to view the JNDI namespace tree as it exists in the server using the JMX agent view interface. To view the JBoss JNDI namespace using the `JNDIView` MBean, you connect to the JMX Agent View using the http interface. The default settings put this at `http://localhost:8080/jmx-console/`. On this page you will see a section that lists the registered MBeans sorted by domain. It should look something like that shown in [Figure 9.4, "The JMX Console view of the configured JBoss MBeans"](#).



**Jboss™ JMX Agent View toki.local**

---

ObjectName Filter (e.g. "jboss:\*", "\*:service=invoker,\*") :

---

**Catalina**

- [type=Server](#)

**JMImplementation**

- [name=Default.service=LoaderRepository](#)
- [type=MBeanRegistry](#)
- [type=MBeanServerDelegate](#)

**jboss**

- [database=localDB.service=Hypersonic](#)
- [name=PropertyEditorManager.type=Service](#)
- [name=SystemProperties.type=Service](#)
- [readonly=true.service=invoker.target=Naming.type=http](#)
- [service=AttributePersistenceService](#)
- [service=ClientUserTransaction](#)
- [service=JNDIView](#)
- [service=KeyGeneratorFactory.type=HiLo](#)
- [service=KeyGeneratorFactory.type=UUID](#)
- [service=Mail](#)
- [service=Naming](#)

Figure 9.4. The JMX Console view of the configured JBoss MBeans

Selecting the JNDIView link takes you to the JNDIView MBean view, which will have a list of the JNDIView MBean operations. This view should look similar to that shown in [Figure 9.5, “The JMX Console view of the JNDIView MBean”](#).

**MBean description:**

JNDIView Service. List deployed application java:comp namespaces, the java: namespace as well as the global InitialContext JNDI namespace.

**List of MBean attributes:**

Name	Type	Access	Value	Description
Name	java.lang.String	R	JNDIView	The class name of the MBean
State	int	R	3	The status of the MBean
StateString	java.lang.String	R	Started	The status of the MBean in text form

**List of MBean operations:****java.lang.String list()**

Output JNDI info as text

Param	ParamType	ParamValue	ParamDescription
verbose	boolean	<input checked="" type="radio"/> True <input type="radio"/> False	If true, list the class of each object in addition to its name

Invoke

**java.lang.String listXML()**

Output JNDI info in XML format

**Figure 9.5. The JMX Console view of the JNDIView MBean**

The list operation dumps out the server JNDI namespace as an HTML page using a simple text view. As an example, invoking the list operation produces the view shown in [Figure 9.6, “The JMX Console view of the JNDIView list operation output”](#).



## java: Namespace

```

+- XAConnectionFactory (class: org.jboss.mq.SpyXAConnectionFactory)
+- DefaultDS (class: javax.sql.DataSource)
+- SecurityProxyFactory (class: org.jboss.security.SubjectSecurityProxyFactory)
+- DefaultJMSProvider (class: org.jboss.jms.jndi.JNDIProviderAdapter)
+- comp (class: javax.naming.Context)
+- JmsXA (class: org.jboss.resource.adapter.jms.JmsConnectionFactoryImpl)
+- ConnectionFactory (class: org.jboss.mq.SpyConnectionFactory)
+- jaas (class: javax.naming.Context)
|   +- JmsXARealm (class: org.jboss.security.plugins.SecurityDomainContext)
|   +- jbossmq (class: org.jboss.security.plugins.SecurityDomainContext)
|   +- HsqlDbRealm (class: org.jboss.security.plugins.SecurityDomainContext)
+- timedCacheFactory (class: javax.naming.Context)
Failed to lookup: timedCacheFactory, errmsg=null
+- TransactionPropagationContextExporter (class: org.jboss.tm.TransactionPropagationContext)
+- StdJMSPool (class: org.jboss.jms.asf.StdServerSessionPoolFactory)
+- Mail (class: javax.mail.Session)
+- TransactionPropagationContextImporter (class: org.jboss.tm.TransactionPropagationContext)
+- TransactionManager (class: org.jboss.tm.TxManager)

```

## Global JNDI Namespace

```

+- XAConnectionFactory (class: org.jboss.mq.SpyXAConnectionFactory)
+- UIL2ConnectionFactory[link -> ConnectionFactory] (class: javax.naming.LinkRef)
+- UserTransactionSessionFactory (proxy: $Proxy11 implements interface org.jboss.tm.usertx)
+- HTTPConnectionFactory (class: org.jboss.mq.SpyConnectionFactory)
+- console (class: org.jnp.interfaces.NamingContext)
|   +- PluginManager (proxy: $Proxy36 implements interface org.jboss.console.manager.Plugin)
+- UIL2XAConnectionFactory[link -> XAConnectionFactory] (class: javax.naming.LinkRef)
+- UUIDKeyGeneratorFactory (class: org.jboss.ejb.plugins.keygenerator.uuid.UUIDKeyGenerator)

```

Figure 9.6. The JMX Console view of the JNDIView list operation output

## 9.6. J2EE AND JNDI - THE APPLICATION COMPONENT ENVIRONMENT

JNDI is a fundamental aspect of the J2EE specifications. One key usage is the isolation of J2EE component code from the environment in which the code is deployed. Use of the application component's environment allows the application component to be customized without the need to access or change the application component's source code. The application component environment is referred to as the ENC, the enterprise naming context. It is the responsibility of the application component container to make an ENC available to the container components in the form of JNDI Context. The ENC is utilized by the participants involved in the life cycle of a J2EE component in the following ways.

- Application component business logic should be coded to access information from its ENC. The component provider uses the standard deployment descriptor for the component to specify the required ENC entries. The entries are declarations of the information and resources the component requires at runtime.
- The container provides tools that allow a deployer of a component to map the ENC references made by the component developer to the deployment environment entity that satisfies the reference.
- The component deployer utilizes the container tools to ready a component for final deployment.

- The component container uses the deployment package information to build the complete component ENC at runtime

The complete specification regarding the use of JNDI in the J2EE platform can be found in section 5 of the J2EE 1.4 specification.

An application component instance locates the ENC using the JNDI API. An application component instance creates a `javax.naming.InitialContext` object by using the no argument constructor and then looks up the naming environment under the name `java:comp/env`. The application component's environment entries are stored directly in the ENC, or in its subcontexts. [Example 9.4, “ENC access sample code”](#) illustrates the prototypical lines of code a component uses to access its ENC.

#### Example 9.4. ENC access sample code

```
// Obtain the application component's ENC
Context iniCtx = new InitialContext();
Context compEnv = (Context) iniCtx.lookup("java:comp/env");
```

An application component environment is a local environment that is accessible only by the component when the application server container thread of control is interacting with the application component. This means that an EJB `Bean1` cannot access the ENC elements of EJB `Bean2`, and vice versa. Similarly, Web application `Web1` cannot access the ENC elements of Web application `Web2` or `Bean1` or `Bean2` for that matter. Also, arbitrary client code, whether it is executing inside of the application server VM or externally cannot access a component's `java:comp` JNDI context. The purpose of the ENC is to provide an isolated, read-only namespace that the application component can rely on regardless of the type of environment in which the component is deployed. The ENC must be isolated from other components because each component defines its own ENC content. Components `A` and `B`, for example, may define the same name to refer to different objects. For example, EJB `Bean1` may define an environment entry `java:comp/env/red` to refer to the hexadecimal value for the RGB color for red, while Web application `Web1` may bind the same name to the deployment environment language locale representation of red.

There are three commonly used levels of naming scope in JBoss: names under `java:comp`, names under `java:`, and any other name. As discussed, the `java:comp` context and its subcontexts are only available to the application component associated with that particular context. Subcontexts and object bindings directly under `java:` are only visible within the server virtual machine and not to remote clients. Any other context or object binding is available to remote clients, provided the context or object supports serialization. You'll see how the isolation of these naming scopes is achieved in the [Section 9.2, “The JBoss Naming Service Architecture”](#).

An example of where the restricting a binding to the `java:` context is useful would be a `javax.sql.DataSource` connection factory that can only be used inside of the server where the associated database pool resides. On the other hand, an EJB home interface would be bound to a globally visible name that should be accessible by remote client.

### 9.6.1. ENC Usage Conventions

JNDI is used as the API for externalizing a great deal of information from an application component. The JNDI name that the application component uses to access the information is declared in the standard `ejb-jar.xml` deployment descriptor for EJB components, and the standard `web.xml` deployment descriptor for Web components. Several different types of information may be stored in and retrieved from JNDI including:

- Environment entries as declared by the `env-entry` elements
- EJB references as declared by `ejb-ref` and `ejb-local-ref` elements.
- Resource manager connection factory references as declared by the `resource-ref` elements
- Resource environment references as declared by the `resource-env-ref` elements

Each type of deployment descriptor element has a JNDI usage convention with regard to the name of the JNDI context under which the information is bound. Also, in addition to the standard `deploymentdescriptor` element, there is a JBoss Enterprise Application Platform specific deployment descriptor element that maps the JNDI name as used by the application component to the deployment environment JNDI name.

### 9.6.1.1. Environment Entries

Environment entries are the simplest form of information stored in a component ENC, and are similar to operating system environment variables like those found on Unix or Windows. Environment entries are a name-to-value binding that allows a component to externalize a value and refer to the value using a name.

An environment entry is declared using an `env-entry` element in the standard deployment descriptors. The `env-entry` element contains the following child elements:

- An optional `description` element that provides a description of the entry
- An `env-entry-name` element giving the name of the entry relative to `java:comp/env`
- An `env-entry-type` element giving the Java type of the entry value that must be one of:
  - `java.lang.Byte`
  - `java.lang.Boolean`
  - `java.lang.Character`
  - `java.lang.Double`
  - `java.lang.Float`
  - `java.lang.Integer`
  - `java.lang.Long`
  - `java.lang.Short`
  - `java.lang.String`
- An `env-entry-value` element giving the value of entry as a string

An example of an `env-entry` fragment from an `ejb-jar.xml` deployment descriptor is given in [Example 9.5, “An example ejb-jar.xml env-entry fragment”](#). There is no JBoss specific deployment descriptor element because an `env-entry` is a complete name and value specification. [Example 9.6, “ENC env-entry access code fragment”](#) shows a sample code fragment for accessing the `maxExemptions` and `taxRate` and `env-entry` values declared in the deployment descriptor.

**Example 9.5. An example ejb-jar.xml env-entry fragment**

```

<!-- ... -->
<session>
  <ejb-name>ASessionBean</ejb-name>
  <!-- ... -->
  <env-entry>
    <description>The maximum number of tax exemptions allowed
  </description>
    <env-entry-name>maxExemptions</env-entry-name>
    <env-entry-type>java.lang.Integer</env-entry-type>
    <env-entry-value>15</env-entry-value>
  </env-entry>
  <env-entry>
    <description>The tax rate </description>
    <env-entry-name>taxRate</env-entry-name>
    <env-entry-type>java.lang.Float</env-entry-type>
    <env-entry-value>0.23</env-entry-value>
  </env-entry>
</session>
<!-- ... -->

```

**Example 9.6. ENC env-entry access code fragment**

```

InitialContext iniCtx = new InitialContext();
Context envCtx = (Context) iniCtx.lookup("java:comp/env");
Integer maxExemptions = (Integer) envCtx.lookup("maxExemptions");
Float taxRate = (Float) envCtx.lookup("taxRate");

```

**9.6.1.2. EJB References**

It is common for EJBs and Web components to interact with other EJBs. Because the JNDI name under which an EJB home interface is bound is a deployment time decision, there needs to be a way for a component developer to declare a reference to an EJB that will be linked by the deployer. EJB references satisfy this requirement.

An EJB reference is a link in an application component naming environment that points to a deployed EJB home interface. The name used by the application component is a logical link that isolates the component from the actual name of the EJB home in the deployment environment. The J2EE specification recommends that all references to enterprise beans be organized in the `java:comp/env/ejb` context of the application component's environment.

An EJB reference is declared using an `ejb-ref` element in the deployment descriptor. Each `ejb-ref` element describes the interface requirements that the referencing application component has for the referenced enterprise bean. The `ejb-ref` element contains the following child elements:

- An optional `description` element that provides the purpose of the reference.
- An `ejb-ref-name` element that specifies the name of the reference relative to the `java:comp/env` context. To place the reference under the recommended `java:comp/env/ejb` context, use an `ejb/link-name` form for the `ejb-ref-name` value.

- An **ejb-ref-type** element that specifies the type of the EJB. This must be either **Entity** or **Session**.
- A **home** element that gives the fully qualified class name of the EJB home interface.
- A **remote** element that gives the fully qualified class name of the EJB remote interface.
- An optional **ejb-link** element that links the reference to another enterprise bean in the same EJB JAR or in the same J2EE application unit. The **ejb-link** value is the **ejb-name** of the referenced bean. If there are multiple enterprise beans with the same **ejb-name**, the value uses the path name specifying the location of the **ejb-jar** file that contains the referenced component. The path name is relative to the referencing **ejb-jar** file. The Application Assembler appends the **ejb-name** of the referenced bean to the path name separated by **#**. This allows multiple beans with the same name to be uniquely identified.

An EJB reference is scoped to the application component whose declaration contains the **ejb-ref** element. This means that the EJB reference is not accessible from other application components at runtime, and that other application components may define **ejb-ref** elements with the same **ejb-ref-name** without causing a name conflict. [Example 9.7, “An example ejb-jar.xml ejb-ref descriptor fragment”](#) provides an **ejb-jar.xml** fragment that illustrates the use of the **ejb-ref** element. A code sample that illustrates accessing the **ShoppingCartHome** reference declared in [Example 9.7, “An example ejb-jar.xml ejb-ref descriptor fragment”](#) is given in [Example 9.8, “ENC ejb-ref access code fragment”](#).

#### Example 9.7. An example ejb-jar.xml ejb-ref descriptor fragment

```

<!-- ... -->
<session>
  <ejb-name>ShoppingCartBean</ejb-name>
  <!-- ... -->
</session>

<session>
  <ejb-name>ProductBeanUser</ejb-name>
  <!-- ... -->
  <ejb-ref>
    <description>This is a reference to the store products entity
  </description>
    <ejb-ref-name>ejb/ProductHome</ejb-ref-name>
    <ejb-ref-type>Entity</ejb-ref-type>
    <home>org.jboss.store.ejb.ProductHome</home>
    <remote> org.jboss.store.ejb.Product</remote>
  </ejb-ref>
</session>

<session>
  <ejb-ref>
    <ejb-name>ShoppingCartUser</ejb-name>
    <!-- ... -->
    <ejb-ref-name>ejb/ShoppingCartHome</ejb-ref-name>
    <ejb-ref-type>Session</ejb-ref-type>
    <home>org.jboss.store.ejb.ShoppingCartHome</home>
    <remote> org.jboss.store.ejb.ShoppingCart</remote>
    <ejb-link>ShoppingCartBean</ejb-link>
  </ejb-ref>
</session>

```

```

        </ejb-ref>
    </session>

    <entity>
        <description>The Product entity bean </description>
        <ejb-name>ProductBean</ejb-name>
        <!--...-->
    </entity>

    <!--...-->

```

### Example 9.8. ENC ejb-ref access code fragment

```

InitialContext iniCtx = new InitialContext();
Context ejbCtx = (Context) iniCtx.lookup("java:comp/env/ejb");
ShoppingCartHome home = (ShoppingCartHome)
    ejbCtx.lookup("ShoppingCartHome");

```

#### 9.6.1.3. EJB References with `jboss.xml` and `jboss-web.xml`

The JBoss specific `jboss.xml` EJB deployment descriptor affects EJB references in two ways. First, the `jndi-name` child element of the `session` and `entity` elements allows the user to specify the deployment JNDI name for the EJB home interface. In the absence of a `jboss.xml` specification of the `jndi-name` for an EJB, the home interface is bound under the `ejb-jar.xml` `ejb-name` value. For example, the session EJB with the `ejb-name` of `ShoppingCartBean` in [Example 9.7, “An example ejb-jar.xml ejb-ref descriptor fragment”](#) would have its home interface bound under the JNDI name `ShoppingCartBean` in the absence of a `jboss.xml` `jndi-name` specification.

The second use of the `jboss.xml` descriptor with respect to `ejb-refs` is the setting of the destination to which a component's ENC `ejb-ref` refers. The `ejb-link` element cannot be used to refer to EJBs in another enterprise application. If your `ejb-ref` needs to access an external EJB, you can specify the JNDI name of the deployed EJB home using the `jboss.xml` `ejb-ref/jndi-name` element.

The `jboss-web.xml` descriptor is used only to set the destination to which a Web application ENC `ejb-ref` refers. The content model for the JBoss `ejb-ref` is as follows:

- An `ejb-ref-name` element that corresponds to the `ejb-ref-name` element in the `ejb-jar.xml` or `web.xml` standard descriptor
- A `jndi-name` element that specifies the JNDI name of the EJB home interface in the deployment environment

[Example 9.9, “An example jboss.xml ejb-ref fragment”](#) provides an example `jboss.xml` descriptor fragment that illustrates the following usage points:

- The `ProductBeanUser` `ejb-ref` link destination is set to the deployment name of `jboss/store/ProductHome`
- The deployment JNDI name of the `ProductBean` is set to `jboss/store/ProductHome`

**Example 9.9. An example jboss.xml ejb-ref fragment**

```

<!-- ... -->
<session>
  <ejb-name>ProductBeanUser</ejb-name>
  <ejb-ref>
    <ejb-ref-name>ejb/ProductHome</ejb-ref-name>
    <jndi-name>jboss/store/ProductHome</jndi-name>
  </ejb-ref>
</session>

<entity>
  <ejb-name>ProductBean</ejb-name>
  <jndi-name>jboss/store/ProductHome</jndi-name>
  <!-- ... -->
</entity>
<!-- ... -->

```

**9.6.1.4. EJB Local References**

EJB 2.0 added local interfaces that do not use RMI call by value semantics. These interfaces use a call by reference semantic and therefore do not incur any RMI serialization overhead. An EJB local reference is a link in an application component naming environment that points to a deployed EJB local home interface. The name used by the application component is a logical link that isolates the component from the actual name of the EJB local home in the deployment environment. The J2EE specification recommends that all references to enterprise beans be organized in the `java:comp/env/ejb` context of the application component's environment.

An EJB local reference is declared using an `ejb-local-ref` element in the deployment descriptor. Each `ejb-local-ref` element describes the interface requirements that the referencing application component has for the referenced enterprise bean. The `ejb-local-ref` element contains the following child elements:

- An optional **description** element that provides the purpose of the reference.
- An **ejb-ref-name** element that specifies the name of the reference relative to the `java:comp/env` context. To place the reference under the recommended `java:comp/env/ejb` context, use an `ejb/link-name` form for the `ejb-ref-name` value.
- An **ejb-ref-type** element that specifies the type of the EJB. This must be either `Entity` or `Session`.
- A **local-home** element that gives the fully qualified class name of the EJB local home interface.
- A **local** element that gives the fully qualified class name of the EJB local interface.
- An **ejb-link** element that links the reference to another enterprise bean in the `ejb-jar` file or in the same J2EE application unit. The `ejb-link` value is the `ejb-name` of the referenced bean. If there are multiple enterprise beans with the same `ejb-name`, the value uses the path name specifying the location of the `ejb-jar` file that contains the referenced component. The path name is relative to the referencing `ejb-jar` file. The Application Assembler appends the

`ejb-name` of the referenced bean to the path name separated by `#`. This allows multiple beans with the same name to be uniquely identified. An `ejb-link` element must be specified in JBoss to match the local reference to the corresponding EJB.

An EJB local reference is scoped to the application component whose declaration contains the `ejb-local-ref` element. This means that the EJB local reference is not accessible from other application components at runtime, and that other application components may define `ejb-local-ref` elements with the same `ejb-ref-name` without causing a name conflict. [Example 9.10, “An example ejb-jar.xml ejb-local-ref descriptor fragment”](#) provides an `ejb-jar.xml` fragment that illustrates the use of the `ejb-local-ref` element. A code sample that illustrates accessing the `ProbeLocalHome` reference declared in [Example 9.10, “An example ejb-jar.xml ejb-local-ref descriptor fragment”](#) is given in [Example 9.11, “ENC ejb-local-ref access code fragment”](#).

#### Example 9.10. An example ejb-jar.xml ejb-local-ref descriptor fragment

```

<!-- ... -->
<session>
  <ejb-name>Probe</ejb-name>
  <home>org.jboss.test.perf.interfaces.ProbeHome</home>
  <remote>org.jboss.test.perf.interfaces.Probe</remote>
  <local-home>org.jboss.test.perf.interfaces.ProbeLocalHome</local-
home>
  <local>org.jboss.test.perf.interfaces.ProbeLocal</local>
  <ejb-class>org.jboss.test.perf.ejb.ProbeBean</ejb-class>
  <session-type>Stateless</session-type>
  <transaction-type>Bean</transaction-type>
</session>
<session>
  <ejb-name>PerfTestSession</ejb-name>
  <home>org.jboss.test.perf.interfaces.PerfTestSessionHome</home>
  <remote>org.jboss.test.perf.interfaces.PerfTestSession</remote>
  <ejb-class>org.jboss.test.perf.ejb.PerfTestSessionBean</ejb-class>
  <session-type>Stateless</session-type>
  <transaction-type>Container</transaction-type>
  <ejb-ref>
    <ejb-ref-name>ejb/ProbeHome</ejb-ref-name>
    <ejb-ref-type>Session</ejb-ref-type>
    <home>org.jboss.test.perf.interfaces.SessionHome</home>
    <remote>org.jboss.test.perf.interfaces.Session</remote>
    <ejb-link>Probe</ejb-link>
  </ejb-ref>
  <ejb-local-ref>
    <ejb-ref-name>ejb/ProbeLocalHome</ejb-ref-name>
    <ejb-ref-type>Session</ejb-ref-type>
    <local-
home>org.jboss.test.perf.interfaces.ProbeLocalHome</local-home>
    <local>org.jboss.test.perf.interfaces.ProbeLocal</local>
    <ejb-link>Probe</ejb-link>
  </ejb-local-ref>
</session>
<!-- ... -->

```

#### Example 9.11. ENC ejb-local-ref access code fragment



```

InitialContext iniCtx = new InitialContext();
Context ejbCtx = (Context) iniCtx.lookup("java:comp/env/ejb");
ProbeLocalHome home = (ProbeLocalHome) ejbCtx.lookup("ProbeLocalHome");

```

### 9.6.1.5. Resource Manager Connection Factory References

Resource manager connection factory references allow application component code to refer to resource factories using logical names called resource manager connection factory references. Resource manager connection factory references are defined by the `resource-ref` elements in the standard deployment descriptors. The `Deployer` binds the resource manager connection factory references to the actual resource manager connection factories that exist in the target operational environment using the `jboss.xml` and `jboss-web.xml` descriptors.

Each `resource-ref` element describes a single resource manager connection factory reference. The `resource-ref` element consists of the following child elements:

- An optional `description` element that provides the purpose of the reference.
- A `res-ref-name` element that specifies the name of the reference relative to the `java:comp/env` context. The resource type based naming convention for which subcontext to place the `res-ref-name` into is discussed in the next paragraph.
- A `res-type` element that specifies the fully qualified class name of the resource manager connection factory.
- A `res-auth` element that indicates whether the application component code performs resource sign on programmatically, or whether the container signs on to the resource based on the principal mapping information supplied by the `Deployer`. It must be one of `Application` or `Container`.
- An optional `res-sharing-scope` element. This currently is not supported by JBoss.

The J2EE specification recommends that all resource manager connection factory references be organized in the subcontexts of the application component's environment, using a different subcontext for each resource manager type. The recommended resource manager type to subcontext name is as follows:

- JDBC `DataSource` references should be declared in the `java:comp/env/jdbc` subcontext.
- JMS connection factories should be declared in the `java:comp/env/jms` subcontext.
- JavaMail connection factories should be declared in the `java:comp/env/mail` subcontext.
- URL connection factories should be declared in the `java:comp/env/url` subcontext.

[Example 9.12, “A web.xml resource-ref descriptor fragment”](#) shows an example `web.xml` descriptor fragment that illustrates the `resource-ref` element usage. [Example 9.13, “ENC resource-ref access sample code fragment”](#) provides a code fragment that an application component would use to access the `DefaultMail` resource declared by the `resource-ref`.

#### Example 9.12. A web.xml resource-ref descriptor fragment

```
<web>
```

```

<!-- ... -->
<servlet>
  <servlet-name>AServlet</servlet-name>
  <!-- ... -->
</servlet>
<!-- ... -->
<!-- JDBC DataSources (java:comp/env/jdbc) -->
<resource-ref>
  <description>The default DS</description>
  <res-ref-name>jdbc/DefaultDS</res-ref-name>
  <res-type>javax.sql.DataSource</res-type>
  <res-auth>Container</res-auth>
</resource-ref>
<!-- JavaMail Connection Factories (java:comp/env/mail) -->
<resource-ref>
  <description>Default Mail</description>
  <res-ref-name>mail/DefaultMail</res-ref-name>
  <res-type>javax.mail.Session</res-type>
  <res-auth>Container</res-auth>
</resource-ref>
<!-- JMS Connection Factories (java:comp/env/jms) -->
<resource-ref>
  <description>Default QueueFactory</description>
  <res-ref-name>jms/QueueFactory</res-ref-name>
  <res-type>javax.jms.QueueConnectionFactory</res-type>
  <res-auth>Container</res-auth>
</resource-ref>
</web>

```

### Example 9.13. ENC resource-ref access sample code fragment

```

Context initCtx = new InitialContext();
javax.mail.Session s = (javax.mail.Session)
initCtx.lookup("java:comp/env/mail/DefaultMail");

```

#### 9.6.1.6. Resource Manager Connection Factory References with `jboss.xml` and `jboss-web.xml`

The purpose of the JBoss `jboss.xml` EJB deployment descriptor and `jboss-web.xml` Web application deployment descriptor is to provide the link from the logical name defined by the `res-ref-name` element to the JNDI name of the resource factory as deployed in JBoss. This is accomplished by providing a `resource-ref` element in the `jboss.xml` or `jboss-web.xml` descriptor. The JBoss `resource-ref` element consists of the following child elements:

- A `res-ref-name` element that must match the `res-ref-name` of a corresponding `resource-ref` element from the `ejb-jar.xml` or `web.xml` standard descriptors
- An optional `res-type` element that specifies the fully qualified class name of the resource manager connection factory
- A `jndi-name` element that specifies the JNDI name of the resource factory as deployed in JBoss

- A `res-url` element that specifies the URL string in the case of a `resource-ref` of type `java.net.URL`

Example 9.14, “A sample `jboss-web.xml` resource-ref descriptor fragment” provides a sample `jboss-web.xml` descriptor fragment that shows sample mappings of the `resource-ref` elements given in Example 9.12, “A `web.xml` resource-ref descriptor fragment”.

#### Example 9.14. A sample `jboss-web.xml` resource-ref descriptor fragment

```
<jboss-web>
  <!-- ... -->
  <resource-ref>
    <res-ref-name>jdbc/DefaultDS</res-ref-name>
    <res-type>javax.sql.DataSource</res-type>
    <jndi-name>java:/DefaultDS</jndi-name>
  </resource-ref>
  <resource-ref>
    <res-ref-name>mail/DefaultMail</res-ref-name>
    <res-type>javax.mail.Session</res-type>
    <jndi-name>java:/Mail</jndi-name>
  </resource-ref>
  <resource-ref>
    <res-ref-name>jms/QueueFactory</res-ref-name>
    <res-type>javax.jms.QueueConnectionFactory</res-type>
    <jndi-name>QueueConnectionFactory</jndi-name>
  </resource-ref>
  <!-- ... -->
</jboss-web>
```

#### 9.6.1.7. Resource Environment References

Resource environment references are elements that refer to administered objects that are associated with a resource (for example, JMS destinations) using logical names. Resource environment references are defined by the `resource-env-ref` elements in the standard deployment descriptors. The **Deployer** binds the resource environment references to the actual administered objects location in the target operational environment using the `jboss.xml` and `jboss-web.xml` descriptors.

Each `resource-env-ref` element describes the requirements that the referencing application component has for the referenced administered object. The `resource-env-ref` element consists of the following child elements:

- An optional `description` element that provides the purpose of the reference.
- A `resource-env-ref-name` element that specifies the name of the reference relative to the `java:comp/env` context. Convention places the name in a subcontext that corresponds to the associated resource factory type. For example, a JMS queue reference named `MyQueue` should have a `resource-env-ref-name` of `jms/MyQueue`.
- A `resource-env-ref-type` element that specifies the fully qualified class name of the referenced object. For example, in the case of a JMS queue, the value would be `javax.jms.Queue`.

Example 9.15, “An example `ejb-jar.xml` resource-env-ref fragment” provides an example `resource-`

`ref-env` element declaration by a session bean. [Example 9.16, “ENC resource-env-ref access code fragment”](#) gives a code fragment that illustrates how to look up the `StockInfo` queue declared by the `resource-env-ref`.

#### Example 9.15. An example `ejb-jar.xml` `resource-env-ref` fragment

```
<session>
  <ejb-name>MyBean</ejb-name>
  <!-- ... -->
  <resource-env-ref>
    <description>This is a reference to a JMS queue used in the
      processing of Stock info
    </description>
    <resource-env-ref-name>jms/StockInfo</resource-env-ref-name>
    <resource-env-ref-type>javax.jms.Queue</resource-env-ref-type>
  </resource-env-ref>
  <!-- ... -->
</session>
```

#### Example 9.16. ENC `resource-env-ref` access code fragment

```
InitialContext iniCtx = new InitialContext();
javax.jms.Queue q = (javax.jms.Queue)
envCtx.lookup("java:comp/env/jms/StockInfo");
```

### 9.6.1.8. Resource Environment References and `jboss.xml`, `jboss-web.xml`

The purpose of the JBoss `jboss.xml` EJB deployment descriptor and `jboss-web.xml` Web application deployment descriptor is to provide the link from the logical name defined by the `resource-env-ref-name` element to the JNDI name of the administered object deployed in JBoss. This is accomplished by providing a `resource-env-ref` element in the `jboss.xml` or `jboss-web.xml` descriptor. The JBoss `resource-env-ref` element consists of the following child elements:

- A `resource-env-ref-name` element that must match the `resource-env-ref-name` of a corresponding `resource-env-ref` element from the `ejb-jar.xml` or `web.xml` standard descriptors
- A `jndi-name` element that specifies the JNDI name of the resource as deployed in JBoss

[Example 9.17, “A sample `jboss.xml` `resource-env-ref` descriptor fragment”](#) provides a sample `jboss.xml` descriptor fragment that shows a sample mapping for the `StockInfo` `resource-env-ref`.

#### Example 9.17. A sample `jboss.xml` `resource-env-ref` descriptor fragment

```
<session>
  <ejb-name>MyBean</ejb-name>
  <!-- ... -->
  <resource-env-ref>
    <resource-env-ref-name>jms/StockInfo</resource-env-ref-name>
    <jndi-name>queue/StockInfoQueue</jndi-name>
```

```
    </resource-env-ref>  
    <!-- ... -->  
</session>
```

## CHAPTER 10. WEB SERVICES

Web services are a key contributing factor in the way Web commerce is conducted today. Web services enable applications to communicate by sending small and large chunks of data to each other.

A web service is essentially a software application that supports interaction of applications over a computer network or the world wide web. Web services usually interact through XML documents that map to an object, computer program, business process or database. To communicate, an application sends a message in XML document format to a web service which sends this message to the respective programs. Responses may be received based on requirements, the web service receives and then sends them in XML document format to the required program or applications. Web services can be used in many ways, examples include supply chain information management and business integration.

JBossWS is a web service framework included as part of the JBoss Enterprise Application Platform. It implements the JAX-WS specification that defines a programming model and run-time architecture for implementing web services in Java, targeted at the Java Platform, Enterprise Edition 5 (Java EE 5). Even though JAX-RPC is still supported (the web service specification for J2EE 1.4), JBossWS does put a clear focus on JAX-WS.



### WARNING

JAX-RPC is not supported for JBoss Web Services CXF Stack.

### 10.1. THE NEED FOR WEB SERVICES

Enterprise systems communication may benefit from a wise adoption of web service technologies. Focusing attention on well designed contracts allows developers to establish an abstract view of their service capabilities. Considering the standardized way contracts are written, this definitely helps communication with third-party systems and eventually supports business-to-business integration; everything is clear and standardized in the contract the provider and consumer agree on. This also reduces the dependencies between implementations allowing other consumers to easily use the provided service without major changes.

Other benefits exist for enterprise systems that incorporate web service technologies for internal heterogenous subsystems communication as web service interoperability boosts service reuse and composition. Web services eliminates the need to rewrite whole functionalities because they were developed by another enterprise department using a different software language.

### 10.2. WHAT WEB SERVICES ARE NOT

Web services are not the solution for every software system communication.

Nowadays they are meant to be used for loosely-coupled coarse-grained communication, message (document) exchange. Recent times has seen many specifications (WS-\*) discussed and finally approved to establish standardized ws-related advanced aspects, including reliable messaging, message-level security and cross-service transactions. Web service specifications also include the notion of registries to collect service contract references, to easily discover service implementations.

This all means that the web services technology platform suits complex enterprise communication and is not simply the latest way of doing remote procedure calls.

## 10.3. DOCUMENT/LITERAL

With document style web services two business partners agree on the exchange of complex business documents that are well defined in XML schema. For example, one party sends a document describing a purchase order, the other responds (immediately or later) with a document that describes the status of the purchase order. The payload of the SOAP message is an XML document that can be validated against XML schema. The document is defined by the style attribute on the SOAP binding.

```
<binding name='EndpointInterfaceBinding' type='tns:EndpointInterface'>
  <soap:binding style='document'
transport='http://schemas.xmlsoap.org/soap/http' />
  <operation name='concat'>
    <soap:operation soapAction='' />
    <input>
      <soap:body use='literal' />
    </input>
    <output>
      <soap:body use='literal' />
    </output>
  </operation>
</binding>
```

With document style web services the payload of every message is defined by a complex type in XML schema.

```
<complexType name='concatType'>
  <sequence>
    <element name='String_1' nillable='true' type='string' />
    <element name='long_1' type='long' />
  </sequence>
</complexType>
<element name='concat' type='tns:concatType' />
```

Therefore, message parts must refer to an element from the schema.

```
<message name='EndpointInterface_concat'>
  <part name='parameters' element='tns:concat' />
</message>
```

The following message definition is invalid.

```
<message name='EndpointInterface_concat'>
  <part name='parameters' type='tns:concatType' />
</message>
```

## 10.4. DOCUMENT/LITERAL (BARE)

Bare is an implementation detail from the Java domain. Neither in the abstract contract (for instance, wsdl+schema) nor at the SOAP message level is a bare endpoint recognizable. A bare endpoint or client uses a Java bean that represents the entire document payload.

```
@WebService
@SOAPBinding(parameterStyle = SOAPBinding.ParameterStyle.BARE)
```

```

public class DocBareServiceImpl
{
    @WebMethod
    public SubmitBareResponse submitPO(SubmitBareRequest poRequest)
    {
        ...
    }
}

```

The trick is that the Java beans representing the payload contain JAXB annotations that define how the payload is represented on the wire.

```

@XmlAccessorType(XmlAccessType.FIELD)
@XmlType(name = "SubmitBareRequest",
namespace="http://soapbinding.samples.jaxws.ws.test.jboss.org/", propOrder
= { "product" })
@XmlRootElement(namespace="http://soapbinding.samples.jaxws.ws.test.jboss.
org/", name = "SubmitPO")
public class SubmitBareRequest
{

    @XmlElement(namespace="http://soapbinding.samples.jaxws.ws.test.jboss.org/
", required = true)
    private String product;

    ...
}

```

## 10.5. DOCUMENT/LITERAL (WRAPPED)

Wrapped is an implementation detail from the Java domain. Neither in the abstract contract (for instance, wsdl+schema) nor at the SOAP message level is a wrapped endpoint recognizable. A wrapped endpoint or client uses the individual document payload properties. Wrapped is the default and does not have to be declared explicitly.

```

@WebService
public class DocWrappedServiceImpl
{
    @WebMethod
    @RequestWrapper (className="org.somepackage.SubmitPO")
    @ResponseWrapper (className="org.somepackage.SubmitPOResponse")
    public String submitPO(String product, int quantity)
    {
        ...
    }
}

```



### NOTE

With JBossWS the request and response wrapper annotations are not required, they will be generated on demand using sensible defaults.

## 10.6. RPC/LITERAL



With RPC there is a wrapper element that names the endpoint operation. Child elements of the RPC parent are the individual parameters. The SOAP body is constructed based on some simple rules:

- The port type operation name defines the endpoint method name
- Message parts are endpoint method parameters

RPC is defined by the style attribute on the SOAP binding.

```
<binding name='EndpointInterfaceBinding' type='tns:EndpointInterface'>
  <soap:binding style='rpc'
transport='http://schemas.xmlsoap.org/soap/http' />
  <operation name='echo'>
    <soap:operation soapAction='' />
    <input>
      <soap:body namespace='http://org.jboss.ws/samples/jsr181pojo'
use='literal' />
    </input>
    <output>
      <soap:body namespace='http://org.jboss.ws/samples/jsr181pojo'
use='literal' />
    </output>
  </operation>
</binding>
```

With RPC style web services the portType names the operation (i.e. the java method on the endpoint)

```
<portType name='EndpointInterface'>
  <operation name='echo' parameterOrder='String_1'>
    <input message='tns:EndpointInterface_echo' />
    <output message='tns:EndpointInterface_echoResponse' />
  </operation>
</portType>
```

Operation parameters are defined by individual message parts.

```
<message name='EndpointInterface_echo'>
  <part name='String_1' type='xsd:string' />
</message>
<message name='EndpointInterface_echoResponse'>
  <part name='result' type='xsd:string' />
</message>
```



#### NOTE

There is no complex type in XML schema that could validate the entire SOAP message payload.

```
@WebService
@SOAPBinding(style = SOAPBinding.Style.RPC)
public class JSEBean01
{
  @WebMethod
  @WebResult(name="result")
```

```

    public String echo(@WebParam(name="String_1") String input)
    {
        ...
    }
}

```

The element names of RPC parameters/return values may be defined using the JAX-WS Annotations#javax.jws.WebParam and JAX-WS Annotations#javax.jws.WebResult respectively.

## 10.7. RPC/ENCODED

SOAP encoding style is defined by [chapter 5](#) of the [SOAP-1.1](#) specification. It has inherent interoperability issues that cannot be fixed. The [Basic Profile-1.0](#) prohibits this encoding style in [4.1.7 SOAP encodingStyle Attribute](#). JBossWS has basic support for RPC/Encoded that is provided as is for simple interop scenarios with SOAP stacks that do not support literal encoding. Specifically, JBossWS does not support:

- element references
- soap arrays as bean properties



### NOTE

This section should not be used in conjunction with JBoss Web Services CXF Stack.

## 10.8. WEB SERVICE ENDPOINTS

JAX-WS simplifies the development model for a web service endpoint a great deal. In short, an endpoint implementation bean is annotated with JAX-WS annotations and deployed to the server. The server automatically generates and publishes the abstract contract (for instance, wsdl+schema) for client consumption. All marshaling/unmarshaling is delegated to JAXB.

## 10.9. PLAIN OLD JAVA OBJECT (POJO)

Let us take a look at simple POJO endpoint implementation. All endpoint associated metadata are provided via JSR-181 annotations

```

@WebService
@SOAPBinding(style = SOAPBinding.Style.RPC)
public class JSEBean01
{
    @WebMethod
    public String echo(String input)
    {
        ...
    }
}

```

## 10.10. THE ENDPOINT AS A WEB APPLICATION

A JAX-WS java service endpoint (JSE) is deployed as a web application.

```
<web-app ...>
```

```

<servlet>
  <servlet-name>TestService</servlet-name>
  <servlet-
class>org.jboss.test.ws.jaxws.samples.jsr181pojo.JSEBean01</servlet-class>
  </servlet>
  <servlet-mapping>
    <servlet-name>TestService</servlet-name>
    <url-pattern>/*</url-pattern>
  </servlet-mapping>
</web-app>

```

## 10.11. PACKAGING THE ENDPOINT

A JSR-181 java service endpoint (JSE) is packaged as a web application in a \*.war file.

```

<war warfile="${build.dir}/libs/jbossws-samples-jsr181pojo.war"
webxml="${build.resources.dir}/samples/jsr181pojo/WEB-INF/web.xml">
  <classes dir="${build.dir}/classes">
    <include
name="org.jboss/test/ws/samples/jsr181pojo/JSEBean01.class"/>
  </classes>
</war>

```



### NOTE

Only the endpoint implementation bean and web.xml file are required.

## 10.12. ACCESSING THE GENERATED WSDL

A successfully deployed service endpoint will show up in the service endpoint manager. This is also where you find the links to the generated WSDL.

```
http://yourhost:8080/jbossws/services
```

It is also possible to generate the abstract contract off line using jboss tools. For details of that see [Top Down \(Using wsconsume\)](#)

## 10.13. EJB3 STATELESS SESSION BEAN (SLSB)

The JAX-WS programming model support the same set of annotations on EJB3 stateless session beans as on [Plain old Java Object \(POJO\)](#) endpoints. EJB-2.1 endpoints are supported using the JAX-RPC programming model.

```

@Stateless
@Remote(EJB3RemoteInterface.class)
@RemoteBinding(jndiBinding = "/ejb3/EJB3EndpointInterface")

@WebService
@SOAPBinding(style = SOAPBinding.Style.RPC)
public class EJB3Bean01 implements EJB3RemoteInterface
{
    @WebMethod

```

```

    public String echo(String input)
    {
        ...
    }
}

```

Above you see an EJB-3.0 stateless session bean that exposes one method both on the remote interface and as an endpoint operation.

### Packaging the endpoint

A JSR-181 EJB service endpoint is packaged as an ordinary ejb deployment.

```

<jar jarfile="${build.dir}/libs/jbossws-samples-jsr181ejb.jar">
  <fileset dir="${build.dir}/classes">
    <include
name="org/jboss/test/ws/samples/jsr181ejb/EJB3Bean01.class"/>
    <include
name="org/jboss/test/ws/samples/jsr181ejb/EJB3RemoteInterface.class"/>
  </fileset>
</jar>

```

### Accessing the generated WSDL

A successfully deployed service endpoint will show up in the service endpoint manager. This is also where you will find the links to the generated WSDL.

```
http://yourhost:8080/jbossws/services
```

It is also possible to generate the abstract contract offline using JbossWS tools. For details of that please see [Top Down \(Using wsconsume\)](#)

## 10.14. ENDPOINT PROVIDER

JAX-WS services typically implement a native Java service endpoint interface (SEI), perhaps mapped from a WSDL port type, either directly or via the use of annotations.

Java SEIs provide a high level Java-centric abstraction that hides the details of converting between Java objects and their XML representations for use in XML-based messages. However, in some cases it is desirable for services to be able to operate at the XML message level. The Provider interface offers an alternative to SEIs and may be implemented by services wishing to work at the XML message level.

A Provider based service instance's invoke method is called for each message received for the service.

```

@WebServiceProvider
@ServiceMode(value = Service.Mode.PAYLOAD)
public class ProviderBeanPayload implements Provider<Source>
{
    public Source invoke(Source req)
    {
        // Access the entire request PAYLOAD and return the response PAYLOAD
    }
}

```

`Service.Mode.PAYLOAD` is the default and does not have to be declared explicitly. You can also use `Service.Mode.MESSAGE` to access the entire SOAP message (for example, with `MESSAGE` the Provider can also see SOAP Headers)

## 10.15. WEBSERVICECONTEXT

The `WebServiceContext` is treated as an injectable resource that can be set at the time an endpoint is initialized. The `WebServiceContext` object will then use thread-local information to return the correct information regardless of how many threads are concurrently being used to serve requests addressed to the same endpoint object.

```
@WebService
public class EndpointJSE
{
    @Resource
    WebServiceContext wsCtx;

    @WebMethod
    public String testGetMessageContext()
    {
        SOAPMessageContext jaxwsContext =
(SOAPMessageContext)wsCtx.getMessageContext();
        return jaxwsContext != null ? "pass" : "fail";
    }
    ...
    @WebMethod
    public String testGetUserPrincipal()
    {
        Principal principal = wsCtx.getUserPrincipal();
        return principal.getName();
    }

    @WebMethod
    public boolean testIsUserInRole(String role)
    {
        return wsCtx.isUserInRole(role);
    }
}
```

## 10.16. WEB SERVICE CLIENTS

### 10.16.1. Service

`Service` is an abstraction that represents a WSDL service. A WSDL service is a collection of related ports, each of which consists of a port type bound to a particular protocol and available at a particular endpoint address.

For most clients, you will start with a set of stubs generated from the WSDL. One of these will be the service, and you will create objects of that class in order to work with the service (see "static case" below).

#### 10.16.1.1. Service Usage

## Static case

Most clients will start with a WSDL file, and generate some stubs using jbossws tools like *wsconsume*. This usually gives a mass of files, one of which is the top of the tree. This is the service implementation class.

The generated implementation class can be recognized as it will have two public constructors, one with no arguments and one with two arguments, representing the wsdl location (a `java.net.URL`) and the service name (a `javax.xml.namespace.QName`) respectively.

Usually you will use the no-argument constructor. In this case the WSDL location and service name are those found in the WSDL. These are set implicitly from the `WebServiceClient` annotation that decorates the generated class.

The following code snippet shows the generated constructors from the generated class:

```
// Generated Service Class

@WebServiceClient(name="StockQuoteService",
    targetNamespace="http://example.com/stocks",
    wsdlLocation="http://example.com/stocks.wsdl")
public class StockQuoteService extends javax.xml.ws.Service
{
    public StockQuoteService()
    {
        super(new URL("http://example.com/stocks.wsdl"), new
QName("http://example.com/stocks", "StockQuoteService"));
    }

    public StockQuoteService(String wsdlLocation, QName serviceName)
    {
        super(wsdlLocation, serviceName);
    }

    ...
}
```

[Section 10.16.2, “Dynamic Proxy”](#) explains how to obtain a port from the service and how to invoke an operation on the port. If you need to work with the XML payload directly or with the XML representation of the entire SOAP message, refer to [Section 10.16.4, “Dispatch”](#).

## Dynamic case

In the dynamic case, when nothing is generated, a web service client uses `Service.create` to create Service instances, the following code illustrates this process.

```
URL wsdlLocation = new URL("http://example.org/my.wsdl");
QName serviceName = new QName("http://example.org/sample", "MyService");
Service service = Service.create(wsdlLocation, serviceName);
```

This is not the recommended way to use JBossWS.

### 10.16.1.2. Handler Resolver

JAX-WS provides a flexible plug-in framework for message processing modules, known as handlers,

that may be used to extend the capabilities of a JAX-WS runtime system. [Section 10.17.1, “Handler Framework”](#) describes the handler framework in detail. A `Service` instance provides access to a `HandlerResolver` via a pair of `getHandlerResolver` and `setHandlerResolver` methods that may be used to configure a set of handlers on a per-service, per-port or per-protocol binding basis.

When a `Service` instance is used to create a proxy or a `Dispatch` instance then the handler resolver currently registered with the service is used to create the required handler chain. Subsequent changes to the handler resolver configured for a `Service` instance do not affect the handlers on previously created proxies, or `Dispatch` instances.

### 10.16.1.3. Executor

`Service` instances can be configured with a `java.util.concurrent.Executor`. The executor will then be used to invoke any asynchronous callbacks requested by the application. The `setExecutor` and `getExecutor` methods of `Service` can be used to modify and retrieve the executor configured for a service.

### 10.16.2. Dynamic Proxy

You can create an instance of a client proxy using one of `getPort` methods on the [Service](#).

```

/**
 * The getPort method returns a proxy. A service client
 * uses this proxy to invoke operations on the target
 * service endpoint. The serviceEndpointInterface
 * specifies the service endpoint interface that is supported by
 * the created dynamic proxy instance.
 */
public <T> T getPort(QName portName, Class<T> serviceEndpointInterface)
{
    ...
}

/**
 * The getPort method returns a proxy. The parameter
 * serviceEndpointInterface specifies the service
 * endpoint interface that is supported by the returned proxy.
 * In the implementation of this method, the JAX-WS
 * runtime system takes the responsibility of selecting a protocol
 * binding (and a port) and configuring the proxy accordingly.
 * The returned proxy should not be reconfigured by the client.
 */
public <T> T getPort(Class<T> serviceEndpointInterface)
{
    ...
}

```

The *Service Endpoint Interface* (SEI) is usually generated using tools. For details see [Top Down \(Using wsconsume\)](#).

A generated static [Service](#) usually also offers typed methods to get ports. These methods also return dynamic proxies that implement the SEI.

```

@WebServiceClient(name = "TestEndpointService", targetNamespace =
"http://org.jboss.ws/wsref",
    wsdlLocation = "http://localhost.localdomain:8080/jaxws-samples-
webservicesref?wsdl")
public class TestEndpointService extends Service
{
    ...

    public TestEndpointService(URL wsdlLocation, QName serviceName) {
        super(wsdlLocation, serviceName);
    }

    @WebEndpoint(name = "TestEndpointPort")
    public TestEndpoint getTestEndpointPort()
    {
        return (TestEndpoint)super.getPort(TESTENDPOINTPORT,
TestEndpoint.class);
    }
}

```

### 10.16.3. WebServiceRef

The `WebServiceRef` annotation is used to declare a reference to a Web service. It follows the resource pattern exemplified by the `javax.annotation.Resource` annotation in [JSR-250](#)

There are two uses to the `WebServiceRef` annotation:

1. To define a reference whose type is a generated service class. In this case, the type and value element will both refer to the generated service class type. Moreover, if the reference type can be inferred by the field or method declaration then the annotation is applied to the type, and value elements *may* have the default value (`Object.class`, that is). If the type cannot be inferred, then at least the type element *must* be present with a non-default value.
2. To define a reference whose type is a SEI. In this case, the type element *may* be present with its default value if the type of the reference can be inferred from the annotated field and method declaration, but the value element *must* always be present and refer to a generated service class type (a subtype of `javax.xml.ws.Service`). The `wsdlLocation` element, if present, overrides the WSDL location information specified in the `WebService` annotation of the referenced generated service class.

```

public class EJB3Client implements EJB3Remote
{
    @WebServiceRef
    public TestEndpointService service4;

    @WebServiceRef
    public TestEndpoint port3;
}

```

#### WebServiceRef Customization

In JBoss Enterprise Application Platform 5.0 we offer a number of overrides and extensions to the `WebServiceRef` annotation. These include:

- define the port that should be used to resolve a container-managed port



- define default Stub property settings for Stub objects
- define the URL of a final WSDL document to be used

Example:

```

<service-ref>
  <service-ref-name>OrganizationService</service-ref-name>
  <wsdl-override>file:/wsdlRepository/organization-service.wsdl</wsdl-
override>
</service-ref>
..
<service-ref>
  <service-ref-name>OrganizationService</service-ref-name>
  <config-name>Secure Client Config</config-name>
  <config-file>META-INF/jbossws-client-config.xml</config-file>
  <handler-chain>META-INF/jbossws-client-handlers.xml</handler-chain>
</service-ref>

<service-ref>
  <service-ref-name>SecureService</service-ref-name>
  <service-class-
name>org.jboss.tests.ws.jaxws.webservicesref.SecureEndpointService</service-
class-name>
  <service-
qname>{http://org.jboss.ws/wsref}SecureEndpointService</service-qname>
  <port-info>
    <service-endpoint-
interface>org.jboss.tests.ws.jaxws.webservicesref.SecureEndpoint</service-
endpoint-interface>
    <port-qname>{http://org.jboss.ws/wsref}SecureEndpointPort</port-
qname>
    <stub-property>
      <name>javax.xml.ws.security.auth.username</name>
      <value>kermit</value>
    </stub-property>
    <stub-property>
      <name>javax.xml.ws.security.auth.password</name>
      <value>thefrog</value>
    </stub-property>
  </port-info>
</service-ref>

```

#### 10.16.4. Dispatch

XML Web Services use XML messages for communication between services and service clients. The higher level JAX-WS APIs are designed to hide the details of converting between Java method invocations and the corresponding XML messages, but in some cases operating at the XML message level is desirable. The Dispatch interface provides support for this mode of interaction.

Dispatch supports two usage modes, identified by the constants `javax.xml.ws.Service.Mode.MESSAGE` and `javax.xml.ws.Service.Mode.PAYLOAD` respectively:

##### Message

In this mode, client applications work directly with protocol-specific message structures. For example, when used with a SOAP protocol binding, a client application would work directly with a SOAP message.

### Message Payload

In this mode, client applications work with the payload of messages rather than the messages themselves. For example, when used with a SOAP protocol binding, a client application would work with the contents of the SOAP Body rather than the SOAP message as a whole.

Dispatch is a low level API that requires clients to construct messages or message payloads as XML and requires an intimate knowledge of the desired message or payload structure. Dispatch is a generic class that supports input and output of messages or message payloads of any type.

```
Service service = Service.create(wsdlURL, serviceName);
Dispatch dispatch = service.createDispatch(portName, StreamSource.class,
Mode.PAYLOAD);

String payload = "<ns1:ping
xmlns:ns1='http://oneway.samples.jaxws.ws.test.jboss.org/'/>";
dispatch.invokeOneWay(new StreamSource(new StringReader(payload)));

payload = "<ns1:feedback
xmlns:ns1='http://oneway.samples.jaxws.ws.test.jboss.org/'/>";
Source retObj = (Source)dispatch.invoke(new StreamSource(new
StringReader(payload)));
```

### 10.16.5. Asynchronous Invocations

The **BindingProvider** interface represents a component that provides a protocol binding for use by clients, it is implemented by proxies and is extended by the **Dispatch** interface.

**BindingProvider** instances may provide asynchronous operation capabilities. When used, asynchronous operation invocations are decoupled from the **BindingProvider** instance at invocation time such that the response context is not updated when the operation completes. Instead a separate response context is made available using the **Response** interface.

```
public void testInvokeAsync() throws Exception
{
    URL wsdlURL = new URL("http://" + getServerHost() + ":8080/jaxws-
samples-asynchronous?wsdl");
    QName serviceName = new QName(targetNS, "TestEndpointService");
    Service service = Service.create(wsdlURL, serviceName);
    TestEndpoint port = service.getPort(TestEndpoint.class);

    Response response = port.echoAsync("Async");

    // access future
    String retStr = (String) response.get();
    assertEquals("Async", retStr);
}
```

### 10.16.6. Oneway Invocations

`@Oneway` indicates that the given web method has only an input message and no output. Typically, a one-way method returns the thread of control to the calling application prior to executing the actual business method.

```

@WebService (name="PingEndpoint")
@SOAPBinding(style = SOAPBinding.Style.RPC)
public class PingEndpointImpl
{
    private static String feedback;
    ...
    @WebMethod
    @Oneway
    public void ping()
    {
        log.info("ping");
        feedback = "ok";
    }
    ...
    @WebMethod
    public String feedback()
    {
        log.info("feedback");
        return feedback;
    }
}

```

## 10.17. COMMON API

This sections describes concepts that apply equally to [Section 10.8, “Web Service Endpoints ”](#) and [Section 10.16, “Web Service Clients”](#).

### 10.17.1. Handler Framework

The handler framework is implemented by a JAX-WS protocol binding in both client and server side runtimes. Proxies, and Dispatch instances, known collectively as binding providers, each use protocol bindings to bind their abstract functionality to specific protocols.

Client and server-side handlers are organized into an ordered list known as a handler chain. The handlers within a handler chain are invoked each time a message is sent or received. Inbound messages are processed by handlers prior to binding provider processing. Outbound messages are processed by handlers after any binding provider processing.

Handlers are invoked with a message context that provides methods to access and modify inbound and outbound messages and to manage a set of properties. Message context properties may be used to facilitate communication between individual handlers and between handlers and client and service implementations. Different types of handlers are invoked with different types of message context.

#### 10.17.1.1. Logical Handler

Handlers that only operate on message context properties and message payloads. Logical handlers are protocol agnostic and are unable to affect protocol specific parts of a message. Logical handlers are handlers that implement `javax.xml.ws.handler.LogicalHandler`.

#### 10.17.1.2. Protocol Handler

Handlers that operate on message context properties and protocol specific messages. Protocol handlers are specific to a particular protocol and may access and change protocol specific aspects of a message. Protocol handlers are handlers that implement any interface derived from `javax.xml.ws.handler.Handler` except `javax.xml.ws.handler.LogicalHandler`.

### 10.17.1.3. Service endpoint handlers

On the service endpoint, handlers are defined using the `@HandlerChain` annotation.

```
@WebService
@HandlerChain(file = "jaxws-server-source-handlers.xml")
public class SOAPEndpointSourceImpl
{
    ...
}
```

The location of the handler chain file supports 2 formats

1. An absolute `java.net.URL` in externalForm. (ex: <http://myhandlers.foo.com/handlerfile1.xml>)
2. A relative path from the source file or class file. (ex: `bar/handlerfile1.xml`)

### 10.17.1.4. Service client handlers

On the client side, handler can be configured using the `@HandlerChain` annotation on the SEI or dynamically using the API.

```
Service service = Service.create(wsdlURL, serviceName);
Endpoint port = (Endpoint)service.getPort(Endpoint.class);

BindingProvider bindingProvider = (BindingProvider)port;
List<Handler> handlerChain = new ArrayList<Handler>();
handlerChain.add(new LogHandler());
handlerChain.add(new AuthorizationHandler());
handlerChain.add(new RoutingHandler());
bindingProvider.getBinding().setHandlerChain(handlerChain); // important!
```

## 10.17.2. Message Context

`MessageContext` is the super interface for all JAX-WS message contexts. It extends `Map<String, Object>` with additional methods and constants to manage a set of properties that enable handlers in a handler chain to share processing related state. For example, a handler may use the `put` method to insert a property in the message context that one or more other handlers in the handler chain may subsequently obtain via the `get` method.

Properties are scoped as either `APPLICATION` or `HANDLER`. All properties are available to all handlers associated with particular endpoint. E.g., if a logical handler puts a property in the message context, that property will also be available to any protocol handlers in the chain during the execution. `APPLICATION` scoped properties are also made available to client applications and service endpoint implementations. The default scope for a property is `HANDLER`.

### 10.17.2.1. Accessing the message context

Users can access the message context in handlers or in endpoints via `@WebServiceContext` annotation.

### 10.17.2.2. Logical Message Context

`LogicalMessageContext` is passed to **Logical Handlers** at invocation time. `LogicalMessageContext` extends `MessageContext` with methods to obtain and modify the message payload, it does not provide access to the protocol specific aspects of a message. A protocol binding defines what component of a message are available via a logical message context. The SOAP binding defines that a logical handler deployed in a SOAP binding can access the contents of the SOAP body but not the SOAP headers whereas the XML/HTTP binding defines that a logical handler can access the entire XML payload of a message.

### 10.17.2.3. SOAP Message Context

`SOAPMessageContext` is passed to **SOAP handlers** at invocation time. `SOAPMessageContext` extends `MessageContext` with methods to obtain and modify the SOAP message payload.

### 10.17.3. Fault Handling

An implementation may throw a `SOAPFaultException`

```
public void throwSoapFaultException()
{
    SOAPFactory factory = SOAPFactory.newInstance();
    SOAPFault fault = factory.createFault("this is a fault string!", new
    QName("http://foo", "FooCode"));
    fault.setFaultActor("mr. actor");
    fault.addDetail().addChildElement("test");
    throw new SOAPFaultException(fault);
}
```

or an application specific user exception

```
public void throwApplicationException() throws UserException
{
    throw new UserException("validation", 123, "Some validation error");
}
```



#### NOTE

In case of the latter JBossWS generates the required fault wrapper beans at runtime if they are not part of the deployment

## 10.18. DATABINDING

### 10.18.1. Using JAXB with non annotated classes

JAXB is heavily driven by Java Annotations on the Java Bindings. It currently does not support an external binding configuration.

In order to support this, we built on a JAXB RI feature whereby it allows you to specify a `RuntimeInlineAnnotationReader` implementation during `JAXBContext` creation (see `JAXBRIContext`).

We call this feature "JAXB Annotation Introduction" and we've made it available for general consumption i.e. it can be checked out, built and used from SVN:

- <http://anonsvn.jboss.org/repos/jbossws/projects/jaxbintros/>

Complete documentation can be found here:

- [JAXB Introductions](#)

## 10.19. ATTACHMENTS

JBoss-WS4EE relied on a deprecated attachments technology called SwA (SOAP with Attachments). SwA required `soap/encoding` which is disallowed by the WS-I Basic Profile. JBossWS provides support for WS-I AP 1.0, and MTOM instead.

### 10.19.1. MTOM/XOP

This section describes Message Transmission Optimization Mechanism (MTOM) and XML-binary Optimized Packaging (XOP), a means of more efficiently serializing XML Infosets that have certain types of content. The related specifications are

- [SOAP Message Transmission Optimization Mechanism \(MTOM\)](#)
- [XML-binary Optimized Packaging \(XOP\)](#)

#### 10.19.1.1. Supported MTOM parameter types

<code>image/jpeg</code>	<code>java.awt.Image</code>
<code>text/xml</code>	<code>javax.xml.transform.Source</code>
<code>application/xml</code>	<code>javax.xml.transform.Source</code>
<code>application/octet-stream</code>	<code>javax.activation.DataHandler</code>

The above table shows a list of supported endpoint parameter types. The recommended approach is to use the `javax.activation.DataHandler` classes to represent binary data as service endpoint parameters.



#### NOTE

Microsoft endpoints tend to send any data as `application/octet-stream`. The only Java type that can easily cope with this ambiguity is `javax.activation.DataHandler`

#### 10.19.1.2. Enabling MTOM per endpoint

On the server side MTOM processing is enabled through the `@BindingType` annotation. JBossWS does handle SOAP1.1 and SOAP1.2. Both come with or without MTOM flavors:

#### MTOM enabled service implementations

```

package org.jboss.test.ws.jaxws.samples.xop.doclit;

import javax.ejb.Remote;
import javax.jws.WebService;
import javax.jws.soap.SOAPBinding;
import javax.xml.ws.BindingType;

@Remote
@WebService(targetNamespace = "http://org.jboss.ws/xop/doclit")
@SOAPBinding(style = SOAPBinding.Style.DOCUMENT, parameterStyle =
SOAPBinding.ParameterStyle.BARE)
@BindingType(value="http://schemas.xmlsoap.org/wsdl/soap/http?mtom=true")
(1)
public interface MTOMEndpoint
{
    ...
}

```

1. The MTOM enabled SOAP 1.1 binding ID

### MTOM enabled clients

Web service clients can use the same approach described above or rely on the **Binding** API to enable MTOM (Excerpt taken from the `org.jboss.test.ws.jaxws.samples.xop.doclit.XOPTestCase`):

```

...
Service service = Service.create(wsdlURL, serviceName);
port = service.getPort(MTOMEndpoint.class);

// enable MTOM
binding = (SOAPBinding)((BindingProvider)port).getBinding();
binding.setMTOMEnabled(true);

```



#### NOTE

Use the JBossWS configuration templates to setup deployment defaults.

### 10.19.2. SwaRef

[WS-I Attachment Profile 1.0](#) defines mechanism to reference MIME attachment parts using [swaRef](#). In this mechanism the content of XML element of type `wsi:swaRef` is sent as MIME attachment and the element inside SOAP Body holds the reference to this attachment in the CID URI scheme as defined by [RFC 2111](#).

#### 10.19.2.1. Using SwaRef with JAX-WS endpoints

JAX-WS endpoints delegate all marshaling/unmarshaling to the JAXB API. The most simple way to enable SwaRef encoding for `DataHandler` types is to annotate a payload bean with the `@XmlAttachmentRef` annotation as shown below:

```

/**
 * Payload bean that will use SwaRef encoding
 */

```

```

@XmlRootElement
public class DocumentPayload
{
    private DataHandler data;

    public DocumentPayload()
    {
    }

    public DocumentPayload(DataHandler data)
    {
        this.data = data;
    }

    @XmlElement
    @XmlAttachmentRef
    public DataHandler getData()
    {
        return data;
    }

    public void setData(DataHandler data)
    {
        this.data = data;
    }
}

```

With document wrapped endpoints you may even specify the `@XmlAttachmentRef` annotation on the service endpoint interface:

```

@WebService
public interface DocWrappedEndpoint
{
    @WebMethod
    DocumentPayload beanAnnotation(DocumentPayload dhw, String test);

    @WebMethod
    @XmlAttachmentRef
    DataHandler parameterAnnotation(@XmlAttachmentRef DataHandler data,
    String test);
}

```

The message would then refer to the attachment part by CID:

```

<env:Envelope xmlns:env='http://schemas.xmlsoap.org/soap/envelope/'>
  <env:Header/>
  <env:Body>
    <ns2:parameterAnnotation
xmlns:ns2='http://swaref.samples.jaxws.ws.test.jboss.org/'>
      <arg0>cid:0-1180017772935-32455963@ws.jboss.org</arg0>
      <arg1>Wrapped test</arg1>
    </ns2:parameterAnnotation>
  </env:Body>
</env:Envelope>

```



### 10.19.2.2. Starting from WSDL

If you chose the contract first approach then you need to ensure that any element declaration that should use SwaRef encoding simply refers to wsi:swaRef schema type:

```
<element name="data" type="wsi:swaRef"
xmlns:wsi="http://ws-i.org/profiles/basic/1.1/xsd"/>
```

Any wsi:swaRef schema type would then be mapped to DataHandler.

## 10.20. TOOLS

The JAX-WS tools provided by JBossWS can be used in a variety of ways. First we will look at server-side development strategies, and then proceed to the client. When developing a Web Service Endpoint (the server-side) you have the option of starting from Java (bottom-up development), or from the abstract contract (WSDL) that defines your service (top-down development). If this is a new service (no existing contract), the bottom-up approach is the fastest route; you only need to add a few annotations to your classes to get a service up and running. However, if you are developing a service with an already defined contract, it is far simpler to use the top-down approach, since the provided tool will generate the annotated code for you.

Bottom-up use cases:

- Exposing an already existing EJB3 bean as a Web Service
- Providing a new service, and you want the contract to be generated for you

Top-down use cases:

- Replacing the implementation of an existing Web Service without breaking compatibility with older clients
- Exposing a service that conforms to a contract specified by a third party (e.g. a vendor that calls you back using an already defined protocol).
- Creating a service that adheres to the XML Schema and WSDL you developed by hand up front

The following JAX-WS command line tools are included in JBossWS:

Command	Description
<code>wsprovide</code>	Generates JAX-WS portable artifacts, and provides the abstract contract. Used for bottom-up development.
<code>wsconsume</code>	Consumes the abstract contract (WSDL and Schema files), and produces artifacts for both a server and client. Used for top-down and client development
<code>wsruncient</code>	Executes a Java client (that has a main method) using the JBossWS classpath.

### 10.20.1. Bottom-Up (Using wsprovide)

The bottom-up strategy involves developing the Java code for your service, and then annotating it using JAX-WS annotations. These annotations can be used to customize the contract that is generated for your service. For example, you can change the operation name to map to anything you like. However, all of the annotations have sensible defaults, so only the `@WebService` annotation is required.

This can be as simple as creating a single class:

```
package echo;

@javax.jws.WebService
public class Echo
{
    public String echo(String input)
    {
        return input;
    }
}
```

A JSE or EJB3 deployment can be built using this class, and it is the only Java code needed to deploy on JBossWS. The WSDL, and all other Java artifacts called "wrapper classes" will be generated for you at deploy time. This actually goes beyond the JAX-WS specification, which requires that wrapper classes be generated using an offline tool. The reason for this requirement is purely a vendor implementation problem, and since we do not believe in burdening a developer with a bunch of additional steps, we generate these as well. However, if you want your deployment to be portable to other application servers, you will need to use a tool and add the generated classes to your deployment.

This is the primary purpose of the `wsprovide` tool, to generate portable JAX-WS artifacts. Additionally, it can be used to "provide" the abstract contract (WSDL file) for your service. This can be obtained by invoking `wsprovide` using the "-w" option:

```
$ javac -d . -classpath jboss-jaxws.jar Echo.java
$ wsprovide -w echo.Echo
Generating WSDL:
EchoService.wsdl
Writing Classes:
echo/jaxws/Echo.class
echo/jaxws/EchoResponse.class
```

Inspecting the WSDL reveals a service called `EchoService`:

```
<service name='EchoService'>
  <port binding='tns:EchoBinding' name='EchoPort'>
    <soap:address location='REPLACE_WITH_ACTUAL_URL' />
  </port>
</service>
```

As expected, this service defines one operation, "echo":

```
<portType name='Echo'>
  <operation name='echo' parameterOrder='echo'>
    <input message='tns:Echo_echo' />
    <output message='tns:Echo_echoResponse' />
  </operation>
</portType>
```

**NOTE**

Remember that **when deploying on JBossWS you do not need to run this tool**. You only need it for generating portable artifacts and/or the abstract contract for your service.

Let us create a POJO endpoint for deployment on JBoss Enterprise Application Platform. A simple `web.xml` needs to be created:

```
<web-app xmlns="http://java.sun.com/xml/ns/j2ee"
xmlns:xsi="http://www.w3.org/2001/XMLSchema-instance"
xsi:schemaLocation="http://java.sun.com/xml/ns/j2ee
http://java.sun.com/xml/ns/j2ee/web-app_2_4.xsd"
version="2.4">

  <servlet>
    <servlet-name>Echo</servlet-name>
    <servlet-class>echo.Echo</servlet-class>
  </servlet>

  <servlet-mapping>
    <servlet-name>Echo</servlet-name>
    <url-pattern>/Echo</url-pattern>
  </servlet-mapping>
</web-app>
```

The `web.xml` and the single class can now be used to create a WAR:

```
$ mkdir -p WEB-INF/classes
$ cp -rp echo WEB-INF/classes/
$ cp web.xml WEB-INF
$ jar cvf echo.war WEB-INF
added manifest
adding: WEB-INF/(in = 0) (out= 0)(stored 0%)
adding: WEB-INF/classes/(in = 0) (out= 0)(stored 0%)
adding: WEB-INF/classes/echo/(in = 0) (out= 0)(stored 0%)
adding: WEB-INF/classes/echo/Echo.class(in = 340) (out= 247)(deflated 27%)
adding: WEB-INF/web.xml(in = 576) (out= 271)(deflated 52%)
```

The war can then be deployed:

```
cp echo.war <JBOSS_HOME>/server/default/deploy
```

At deploy time JBossWS will internally invoke `wsprovide`, which will generate the WSDL. If deployment was successful, and you are using the default settings, it should be available here:

<http://localhost:8080/echo/Echo?wsdl>

For a portable JAX-WS deployment, the wrapper classes generated earlier could be added to the deployment.

### 10.20.2. Top-Down (Using `wsconsume`)

The top-down development strategy begins with the abstract contract for the service, which includes the WSDL file and zero or more schema files. The `wsconsume` tool is then used to consume this contract, and produce annotated Java classes (and optionally sources) that define it.



## NOTE

`wsconsume` seems to have a problem with symlinks on unix systems

Using the WSDL file from the bottom-up example, a new Java implementation that adheres to this service can be generated. The `-k` option is passed to `wsconsume` to preserve the Java source files that are generated, instead of providing just classes:

```
$ wsconsume -k EchoService.wsdl
echo/Echo.java
echo/EchoResponse.java
echo/EchoService.java
echo/Echo_Type.java
echo/ObjectFactory.java
echo/package-info.java
echo/Echo.java
echo/EchoResponse.java
echo/EchoService.java
echo/Echo_Type.java
echo/ObjectFactory.java
echo/package-info.java
```

The following table shows the purpose of each generated file:

File	Purpose
Echo.java	Service Endpoint Interface
Echo_Type.java	Wrapper bean for request message
EchoResponse.java	Wrapper bean for response message
ObjectFactory.java	JAXB XML Registry
package-info.java	Holder for JAXB package annotations
EchoService.java	Used only by JAX-WS clients

Examining the Service Endpoint Interface reveals annotations that are more explicit than in the class written by hand in the bottom-up example, however, these evaluate to the same contract:

```
@WebService(name = "Echo", targetNamespace = "http://echo/")
public interface Echo
{
    @WebMethod
    @WebResult(targetNamespace = "")
    @RequestWrapper(localName = "echo", targetNamespace = "http://echo/",
```

```

className = "echo.Echo_Type")
    @ResponseWrapper(localName = "echoResponse", targetNamespace =
"http://echo/", className = "echo.EchoResponse")
    public String echo(@WebParam(name = "arg0", targetNamespace = "")
String arg0);
}

```

The only missing piece (besides the packaging) is the implementation class, which can now be written using the above interface.

```

package echo;

@javax.jws.WebService(endpointInterface="echo.Echo")
public class EchoImpl implements Echo
{
    public String echo(String arg0)
    {
        return arg0;
    }
}

```

### 10.20.3. Client Side

Before going into detail on the client-side it is important to understand the decoupling concept that is central to Web Services. Web Services are not the best fit for internal RPC, even though they can be used in this way; there are much better technologies for achieving this (CORBA, and RMI for example). Web Services were designed specifically for interoperable coarse-grained correspondence. There is no expectation or guarantee that any party participating in a Web Service interaction will be at any particular location, running on any particular operating system, or written in any particular programming language. So because of this, it is important to clearly separate client and server implementations. The only thing they should have in common is the abstract contract definition. If, for whatever reason, your software does not adhere to this principal, then you should not be using Web Services. For the above reasons, the *recommended methodology for developing a client* is to follow *the top-down approach*, even if the client is running on the same server.

Let us repeat the process of the top-down section, although using the deployed WSDL, instead of the one generated offline by [wsprovide](#). The reason why we do this is just to get the right value for soap:address. This value must be computed at deploy time, since it is based on container configuration specifics. You could of course edit the WSDL file yourself, although you need to ensure that the path is correct.

Offline version:

```

<service name='EchoService'>
    <port binding='tns:EchoBinding' name='EchoPort'>
        <soap:address location='REPLACE_WITH_ACTUAL_URL' />
    </port>
</service>

```

Online version:

```

<service name="EchoService">
    <port binding="tns:EchoBinding" name="EchoPort">
        <soap:address

```

```
location="http://localhost.localdomain:8080/echo/Echo"/>
  </port>
</service>
```

Using the online deployed version with [wsconsume](#):

```
$ wsconsume -k http://localhost:8080/echo/Echo?wsdl
echo/Echo.java
echo/EchoResponse.java
echo/EchoService.java
echo/Echo_Type.java
echo/ObjectFactory.java
echo/package-info.java
echo/Echo.java
echo/EchoResponse.java
echo/EchoService.java
echo/Echo_Type.java
echo/ObjectFactory.java
echo/package-info.java
```

The one class that was not examined in the top-down section, was **EchoService.java**. Notice how it stores the location the WSDL was obtained from.

```
@WebServiceClient(name = "EchoService", targetNamespace = "http://echo/",
wsdlLocation = "http://localhost:8080/echo/Echo?wsdl")
public class EchoService extends Service
{
    private final static URL ECHOSERVICE_WSDL_LOCATION;

    static
    {
        URL url = null;
        try
        {
            url = new URL("http://localhost:8080/echo/Echo?wsdl");
        }
        catch (MalformedURLException e)
        {
            e.printStackTrace();
        }
        ECHOSERVICE_WSDL_LOCATION = url;
    }

    public EchoService(URL wsdlLocation, QName serviceName)
    {
        super(wsdlLocation, serviceName);
    }

    public EchoService()
    {
        super(ECHOSERVICE_WSDL_LOCATION, new QName("http://echo/",
"EchoService"));
    }

    @WebEndpoint(name = "EchoPort")
```

```

public Echo getEchoPort()
{
    return (Echo)super.getPort(new QName("http://echo/", "EchoPort"),
Echo.class);
}
}

```

As you can see, this generated class extends the main client entry point in JAX-WS, `javax.xml.ws.Service`. While you can use `Service` directly, this is far simpler since it provides the configuration info for you. The only method we really care about is the `getEchoPort()` method, which returns an instance of our `Service Endpoint Interface`. Any Web Services operation can then be called by just invoking a method on the returned interface.

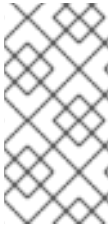

#### NOTE

It is not recommended to refer to a remote WSDL URL in a production application. This causes network I/O every time you instantiate the Service Object. Instead, use the tool on a saved local copy, or use the URL version of the constructor to provide a new WSDL location.



#### NOTE

The `wsdlLocation` is used when creating the Service to be used by clients and will be added to the `@WebServiceClient` annotation, for an endpoint implementation based on the generated service endpoint interface you will need to manually add the `wsdlLocation` to the `@WebService` annotation on your web service implementation and not the service endpoint interface.

All that is left to do, is write and compile the client:

```

import echo.*;
..
public class EchoClient
{
    public static void main(String args[])
    {
        if (args.length != 1)
        {
            System.err.println("usage: EchoClient <message>");
            System.exit(1);
        }

        EchoService service = new EchoService();
        Echo echo = service.getEchoPort();
        System.out.println("Server said: " + echo.echo(args[0]));
    }
}

```

It can then be easily executed using the `wsruncient` tool. This is just a convenience tool that invokes `java` with the needed classpath:

```

$ wsruncient EchoClient 'Hello World!'
Server said: Hello World!

```

It is easy to change the endpoint address of your operation at runtime, setting `ENDPOINT_ADDRESS_PROPERTY` as shown below:

```
...
EchoService service = new EchoService();
Echo echo = service.getEchoPort();

/* Set NEW Endpoint Location */
String endpointURL = "http://NEW_ENDPOINT_URL";
BindingProvider bp = (BindingProvider)echo;
bp.getRequestContext().put(BindingProvider.ENDPOINT_ADDRESS_PROPERTY,
    endpointURL);

System.out.println("Server said: " + echo.echo(args[0]));
...
```

#### 10.20.4. Command-line & Ant Task Reference

- [wsconsume reference page](#)
- [wsprovide reference page](#)
- [wsrunclient reference page](#)

#### 10.20.5. JAX-WS binding customization

An introduction to binding customizations:

- <http://java.sun.com/webservices/docs/2.0/jaxws/customizations.html>

### 10.21. WEB SERVICE EXTENSIONS

#### 10.21.1. WS-Addressing

This section describes how [WS-Addressing](#) can be used to provide a stateful service endpoint.

##### 10.21.1.1. Specifications

WS-Addressing is defined by a combination of the following specifications from the W3C Recommendation. The WS-Addressing API is standardized by [JSR-224 - Java API for XML-Based Web Services \(JAX-WS\)](#)

- [Web Services Addressing 1.0 - Core](#)
- [Web Services Addressing 1.0 - SOAP Binding](#)

##### 10.21.1.2. Addressing Endpoint

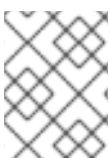

#### NOTE

The following information should not be used in conjunction with JBoss Web Services CXF Stack.



The following endpoint implementation has a set of operation for a typical stateful shopping chart application.

```

@WebService(name = "StatefulEndpoint", targetNamespace =
"http://org.jboss.ws/samples/wsaddressing", serviceName = "TestService")
@Addressing(enabled=true, required=true)
@SOAPBinding(style = SOAPBinding.Style.RPC)
public class StatefulEndpointImpl implements StatefulEndpoint,
ServiceLifecycle
{
    @WebMethod
    public void addItem(String item)
    { ... }

    @WebMethod
    public void checkout()
    { ... }

    @WebMethod
    public String getItems()
    { ... }
}

```

It uses the JAX-WS 2.1 defined `javax.xml.ws.soap.Addressing` annotation to enable the server side addressing handler.

### 10.21.1.3. Addressing Client

The client code uses `javax.xml.ws.soap.AddressingFeature` feature from JAX-WS 2.1 API to enable the WS-Addressing.

```

Service service = Service.create(wsdlURL, serviceName);
port1 = (StatefulEndpoint)service.getPort(StatefulEndpoint.class, new
AddressingFeature());

```

#### A client connecting to the stateful endpoint

```

public class AddressingStatefulTestCase extends JBossWSTest
{
    ...
    public void testAddItem() throws Exception
    {
        port1.addItem("Ice Cream");
        port1.addItem("Ferrari");

        port2.addItem("Mars Bar");
        port2.addItem("Porsche");
    }

    public void testGetItems() throws Exception
    {
        String items1 = port1.getItems();
        assertEquals("[Ice Cream, Ferrari]", items1);

        String items2 = port2.getItems();
    }
}

```

```

        assertEquals("[Mars Bar, Porsche]", items2);
    }
}

```

## SOAP message exchange

Below you see the SOAP messages that are being exchanged.

```

<env:Envelope xmlns:env='http://schemas.xmlsoap.org/soap/envelope/'>
<env:Header xmlns:wsa='http://schemas.xmlsoap.org/ws/2004/08/addressing'>
<wsa:To>uri:jbossws-samples-wsaddr/TestService</wsa:To>
<wsa:Action>http://org.jboss.ws/addressing/stateful/action</wsa:Action>
<wsa:ReferenceParameters>
<ns1:clientid xmlns:ns1='http://somens'>clientid-1</ns1:clientid>
</wsa:ReferenceParameters>
</env:Header>
<env:Body>
<ns1:addItem xmlns:ns1='http://org.jboss.ws/samples/wsaddr'>
<String_1>Ice Cream</String_1>
</ns1:addItem>
</env:Body>
</env:Envelope>

<env:Envelope xmlns:env='http://schemas.xmlsoap.org/soap/envelope/'>
<env:Header xmlns:wsa='http://schemas.xmlsoap.org/ws/2004/08/addressing'>
<wsa:To>http://www.w3.org/2005/08/addressing/anonymous</wsa:To>
<wsa:Action>http://org.jboss.ws/addressing/stateful/actionReply</wsa:Actio
n>
<ns1:clientid xmlns:ns1='http://somens'>clientid-1</ns1:clientid>
</env:Header>
<env:Body>
<ns1:addItemResponse xmlns:ns1='http://org.jboss.ws/samples/wsaddr'/>
</env:Body>
</env:Envelope>

...

<env:Envelope xmlns:env='http://schemas.xmlsoap.org/soap/envelope/'>
<env:Header xmlns:wsa='http://schemas.xmlsoap.org/ws/2004/08/addressing'>
<wsa:To>uri:jbossws-samples-wsaddr/TestService</wsa:To>
<wsa:Action>http://org.jboss.ws/addressing/stateful/action</wsa:Action>
<wsa:ReferenceParameters>
<ns1:clientid xmlns:ns1='http://somens'>clientid-1</ns1:clientid>
</wsa:ReferenceParameters>
</env:Header>
<env:Body>
<ns1:getItems xmlns:ns1='http://org.jboss.ws/samples/wsaddr'/>
</env:Body>
</env:Envelope>

<env:Envelope xmlns:env='http://schemas.xmlsoap.org/soap/envelope/'>
<env:Header xmlns:wsa='http://schemas.xmlsoap.org/ws/2004/08/addressing'>
<wsa:To>http://www.w3.org/2005/08/addressing/anonymous</wsa:To>
<wsa:Action>http://org.jboss.ws/addressing/stateful/actionReply</wsa:Actio
n>
<ns1:clientid xmlns:ns1='http://somens'>clientid-1</ns1:clientid>

```

```

</env:Header>
<env:Body>
<ns1:getItemsResponse xmlns:ns1='http://org.jboss.ws/samples/wsaddr'>
<result>[Ice Cream, Ferrari]</result>
</ns1:getItemsResponse>
</env:Body>
</env:Envelope>

```

## 10.21.2. WS-Security

WS-Security addresses message level security. It standardizes authorization, encryption, and digital signature processing of web services. Unlike transport security models, such as SSL, WS-Security applies security directly to the elements of the web service message. This increases the flexibility of your web services, by allowing any message model to be used (for example, point to point, or multi-hop relay).

This chapter describes how to use WS-Security to sign and encrypt a simple SOAP message.

### Specifications

WS-Security is defined by the combination of the following specifications:

- [SOAP Message Security 1.0](#)
- [Username Token Profile 1.0](#)
- [X.509 Token Profile 1.0](#)
- [W3C XML Encryption](#)
- [W3C XML Signature](#)
- [Basic Security Profile 1.0](#)

### 10.21.2.1. Endpoint configuration

JBossWS uses handlers to identify ws-security encoded requests and invoke the security components to sign and encrypt messages. In order to enable security processing, the client and server side must include a corresponding handler configuration. The preferred way is to reference a predefined [JAX-WS Endpoint Configuration](#) or [JAX-WS Client Configuration](#) respectively.



#### NOTE

You must setup both the endpoint configuration and the WSSE declarations. These are two separate steps.

### 10.21.2.2. Server side WSSE declaration (jboss-wsse-server.xml)

In this example we configure both the client and the server to sign the message body. Both also require this from each other. So, if you remove either the client or the server security deployment descriptor, you will notice that the other party will throw a fault explaining that the message did not conform to the proper security requirements.

```

<jboss-ws-security xmlns="http://www.jboss.com/ws-security/config"
xmlns:xsi="http://www.w3.org/2001/XMLSchema-instance"

```

```

xsi:schemaLocation="http://www.jboss.com/ws-security/config
http://www.jboss.com/ws-security/schema/jboss-ws-security_1_0.xsd">
  <key-store-file>WEB-INF/wsse.keystore</key-store-file>
  1
  <key-store-password>jbossws</key-store-password>
  2
  <trust-store-file>WEB-INF/wsse.truststore</trust-store-file>
  3
  <trust-store-password>jbossws</trust-store-password>
  4
  <config>
  5
    <sign type="x509v3" alias="wsse"/>
  6
    <requires>
  7
      <signature/>
  8
    </requires>
  </config>
</jboss-ws-security>

```

1	This specifies that the key store we wish to use is <b>WEB-INF/wsse.keystore</b> , which is located in our war file.
2	This specifies that the store password is "jbossws". Password can be encrypted using the {EXT} and {CLASS} commands. Please see samples for their usage.
3	This specifies that the trust store we wish to use is <b>WEB-INF/wsse.truststore</b> , which is located in our war file.
4	This specifies that the trust store password is also "jbossws". Password can be encrypted using the {EXT} and {CLASS} commands. Please see samples for their usage.
5	Here we start our root config block. The root config block is the default configuration for all services in this war file.
6	This means that the server must sign the message body of all responses. Type means that we are using X.509v3 certificate (a standard certificate). The alias option says that the certificate and key pair to use for signing is in the key store under the "wsse" alias

<b>7</b>	Here we start our optional requires block. This block specifies all security requirements that must be met when the server receives a message.
<b>8</b>	This means that all web services in this war file require the message body to be signed.

By default an endpoint does not use the WS-Security configuration. Users can use proprietary `@EndpointConfig` annotation to set the config name. See [JAX-WS\\_Endpoint\\_Configuration](#) for the list of available config names.

```
@WebService
@EndpointConfig(configName = "Standard WSSecurity Endpoint")
public class HelloJavaBean
{
    ...
}
```

### 10.21.2.3. Client side WSSE declaration (jboss-wsse-client.xml)

```
<jboss-ws-security xmlns="http://www.jboss.com/ws-security/config"
xmlns:xsi="http://www.w3.org/2001/XMLSchema-instance"
xsi:schemaLocation="http://www.jboss.com/ws-security/config
http://www.jboss.com/ws-security/schema/jboss-ws-security_1_0.xsd">
  <config>
    1
    <sign type="x509v3" alias="wsse"/>
    2
    <requires>
    3
    <signature/>
    4
    </requires>
  </config>
</jboss-ws-security>
```

<b>1</b>	Here we start our root config block. The root config block is the default configuration for all web service clients (Call, Proxy objects).
<b>2</b>	This means that the client must sign the message body of all requests it sends. Type means that we are to use a X.509v3 certificate (a standard certificate). The alias option says that the certificate/key pair to use for signing is in the key store under the "wsse" alias
<b>3</b>	Here we start our optional requires block. This block specifies all security requirements that must be met when the client receives a response.
<b>4</b>	This means that all web service clients must receive signed response messages.

### 10.21.2.3.1. Client side key store configuration

We did not specify a key store or trust store, because client apps instead use the wsse System properties instead. If this was a web or ejb client (meaning a web service client in a war or ejb jar file), then we would have specified them in the client descriptor.

Here is an excerpt from the JBossWS samples:

```
<sysproperty key="org.jboss.ws.wsse.keyStore"
value="${tests.output.dir}/resources/jaxrpc/samples/wssecurity/wsse.keysto
re"/>
<sysproperty key="org.jboss.ws.wsse.trustStore"
value="${tests.output.dir}/resources/jaxrpc/samples/wssecurity/wsse.trusts
tore"/>
<sysproperty key="org.jboss.ws.wsse.keyStorePassword" value="jbossws"/>
<sysproperty key="org.jboss.ws.wsse.trustStorePassword" value="jbossws"/>
<sysproperty key="org.jboss.ws.wsse.keyStoreType" value="jks"/>
<sysproperty key="org.jboss.ws.wsse.trustStoreType" value="jks"/>
```

### SOAP message exchange

Below you see the incoming SOAP message with the details of the security headers omitted. The idea is, that the SOAP body is still plain text, but it is signed in the security header and therefore can not be manipulated in transit.

```
<env:Envelope xmlns:env="http://schemas.xmlsoap.org/soap/envelope/">
<env:Header>
<wsse:Security env:mustUnderstand="1" ...>
<wsu:Timestamp wsu:Id="timestamp">...</wsu:Timestamp>
<wsse:BinarySecurityToken ...>
...
</wsse:BinarySecurityToken>
<ds:Signature xmlns:ds="http://www.w3.org/2000/09/xmldsig#">
...
</ds:Signature>
</wsse:Security>
</env:Header>
<env:Body wsu:Id="element-1-1140197309843-12388840" ...>
<ns1:echoUserType xmlns:ns1="http://org.jboss.ws/samples/wssecurity">
<UserType_1 xmlns:xsi="http://www.w3.org/2001/XMLSchema-instance">
<msg>Kermit</msg>
</UserType_1>
</ns1:echoUserType>
</env:Body>
</env:Envelope>
```

### 10.21.2.4. Installing the BouncyCastle JCE provider

The information below has originally been provided by [The Legion of the Bouncy Castle](#) .

The provider can be configured as part of your environment via static registration by adding an entry to the `java.security` properties file (found in `$JAVA_HOME/jre/lib/security/java.security`, where `$JAVA_HOME` is the location of your JDK and JRE distribution). You will find detailed instructions in the file but basically it comes down to adding a line:

```
security.provider.<n>=org.bouncycastle.jce.provider.BouncyCastleProvider
```

Where `<n>` is the preference you want the provider at.



#### NOTE

Issues may arise if the Sun provided providers are not first.

The location of the provider jar is mostly arbitrary, although some common conventions exist. Under Windows there will normally be a JRE and a JDK install of Java. If you think it's installed it correctly but it still does not work then with high probability the provider installation is not used.

### 10.21.2.5. Username Token Authentication

If you need to authenticate clients through a Username Token, the JAAS integration will verify the received token against the configured JBoss JAAS Security Domain.

#### Example 10.1. Basic Username Token Configuration

To implement this feature, you must append a `<jboss-ws-security>` element to `jboss-wsse-client.xml` that contains the following information.

```
<jboss-ws-security xmlns="http://www.jboss.com/ws-security/config"
  xmlns:xsi="http://www.w3.org/2001/XMLSchema-instance"
  xsi:schemaLocation="http://www.jboss.com/ws-security/config
  http://www.jboss.com/ws-security/schema/jboss-ws-security_1_0.xsd">
  <config>
    <username/>
    <timestamp ttl="300"/>
    </config>
</jboss-ws-security>
```

1

- This line specifies that a `<timestamp>` element must be present in the message and that the message can not be older than 300 seconds. The seconds limitation is used to prevent replay attacks.

You must then specify the same `<timestamp>` element and *seconds* attribute in the `jboss-wsse-server.xml` file so both headers match. You must also specify the `<requires/>` element to enforce this condition.

```
<jboss-ws-security xmlns="http://www.jboss.com/ws-security/config"
  xmlns:xsi="http://www.w3.org/2001/XMLSchema-instance"
  xsi:schemaLocation="http://www.jboss.com/ws-security/config
  http://www.jboss.com/ws-security/schema/jboss-ws-
security_1_0.xsd">
  <config>
    <timestamp ttl="300"/>
    <requires/>
  </config>
</jboss-ws-security>
```

**WARNING**

This example configuration results in simple text user information being sent in SOAP headers. You should strongly consider implementing JBossWS Secure Transport

**Password Digest, Nonces, and Timestamp**

[Example 10.1, “Basic Username Token Configuration”](#) results in the client password being sent as plain text. You can use a combination of *digested passwords*, *nonces*, and *timestamps* to provide further protection from replay attacks.

To enable password digesting, you must implement the following items as described in [Example 10.2, “Enable Password Digesting”](#):

**Example 10.2. Enable Password Digesting**

```
<jboss-ws-security xmlns="http://www.jboss.com/ws-security/config"
  xmlns:xsi="http://www.w3.org/2001/XMLSchema-instance"
  xsi:schemaLocation="http://www.jboss.com/ws-security/config
    http://www.jboss.com/ws-security/schema/jboss-ws-security_1_0.xsd">
  <config>
    <username digestPassword="true" useNonce="true"
      useCreated="true"/>
    <timestamp ttl="300"/>
  </config>
</jboss-ws-security>
```

- ❶ The `<username>` element of the `jboss-wsse-client.xml` file enables the *digestPassword*, *nonces* and *timestamps* attributes.

In the `login-config.xml` file, you must also implement the `UsernameTokenCallback` module option.

**Example 10.3. UsernameTokenCallback Module**

```
<application-policy name="JBossWSDigest">
  <authentication>
    <login-module
      code="org.jboss.security.auth.spi.UsersRolesLoginModule"
      flag="required">
      <module-option name="usersProperties">META-INF/jbossws-
        users.properties</module-option>
    </login-module>
  </authentication>
</application-policy>
```



```

    <module-option name="rolesProperties">META-INF/jbossws-
roles.properties</module-option>
    <module-option name="hashAlgorithm">SHA</module-option>
    <module-option name="hashEncoding">BASE64</module-option>
    <module-option name="hashUserPassword">>false</module-option>
    <module-option name="hashStorePassword">>true</module-option>
    <module-option
name="storeDigestCallback">org.jboss.ws.extensions.security.auth.callbac
k.UsernameTokenCallback</module-option>
    <module-option name="unauthenticatedIdentity">anonymous</module-
option>
  </login-module>
</authentication>
</application-policy>

```

You may wish to use a more sophisticated custom login module to provide more security against replay attacks. You can use your own custom login module provided you implement the following:

- plug the `UsernameTokenCallback` callback into your login module
- extend the `org.jboss.security.auth.spi.UsernamePasswordLoginModule`
- set the hash attributes (*hashAlgorithm*, *hashEncoding*, *hashUserPassword*, *hashStorePassword*) as shown in [Example 10.3, “UsernameTokenCallback Module”](#).

#### Advanced Tuning - Nonce Factory

The way nonces are created, and subsequently checked and stored on the server side, influences overall security against replay attacks. Currently JBossWS ships with a basic implementation of a nonce store that does not cache the received tokens on the server side.

More complex implementation can be plugged into your modules by implementing the `NonceFactory` and `NonceStore` interfaces. You can find these interfaces in the `org.jboss.ws.extensions.security.nonce` package.

Once included, you specify your factory class through the `<nonce-factory-class>` element in the `jboss-wsse-server.xml` file.

#### Advanced Tuning - Timestamp Verification

If a `Timestamp` is present in the `wsse:Security` header, header verification does not allow for any tolerance whatsoever in the time comparisons. If the message appears to have been created even slightly in the future or if the message has just expired it will be rejected. A new element called `<timestamp-verification>` is available for the `wsse` configuration. [Example 10.4, “<timestamp-verification> Configuration”](#) describes the required attributes for the `<timestamp-verification>` element.

##### Example 10.4. `<timestamp-verification>` Configuration

The `<timestamp-verification>` element attributes allow you to specify the tolerance in seconds that is used when verifying the 'Created' or 'Expires' element of the 'Timestamp' header.

```

<jboss-ws-security xmlns='http://www.jboss.com/ws-security/config'
                  xmlns:xsi='http://www.w3.org/2001/XMLSchema-
instance'

```

```

        xsi:schemaLocation='http://www.jboss.com/ws-
security/config
        http://www.jboss.com/ws-security/schema/jboss-ws-
security_1_0.xsd'>
    <timestamp-verification createdTolerance="5" warnCreated="false"
expiresTolerance="10" warnExpires="false" />
</jboss-ws-security>

```

***createdTolerance***

Number of seconds in the future a message will be accepted. The default value is 0.

***expiresTolerance***

Number of seconds a message is rejected after being classed as expired. The default value is 0.

***warnCreated***

Specifies whether to log a warning message if a message is accepted with a 'Created' value in the future. The default value is **true**.

***warnExpires***

Specifies whether to log a warning message if a message is accepted with an 'Expired' value in the past. The default value is **true**.

**NOTE**

The *warnCreated* and *warnExpires* attributes can be used to identify accepted messages that would normally be rejected. You can use this data to identify clients that are out of sync with the server time, without rejecting the client messages.

**10.21.2.5.1. Secure Transport****10.21.2.6. X509 Certificate Token**

By using X509v3 certificates, you can both sign and encrypt messages.

**Encryption**

To configure encryption, you must specify the items in [Example 10.5, “X509 Encryption Configuration”](#). The configuration is the same for clients and servers.

**Example 10.5. X509 Encryption Configuration**

The server configuration includes the following encryption information:

```

<jboss-ws-security xmlns="http://www.jboss.com/ws-security/config"
  xmlns:xsi="http://www.w3.org/2001/XMLSchema-instance"
  xsi:schemaLocation="http://www.jboss.com/ws-security/config
  http://www.jboss.com/ws-security/schema/jboss-ws-
security_1_0.xsd">
  <key-store-file>WEB-INF/bob-sign_enc.jks</key-store-file>

```

1

```

<key-store-password>password</key-store-password>
<key-store-type>jks</key-store-type>
<trust-store-file>WEB-INF/wsse10.truststore</trust-store-file>
<trust-store-password>password</trust-store-password>

```

```

<config>
  <timestamp ttl="300"/>
  <sign type="x509v3" alias="1" includeTimestamp="true"/>

```

2

```

<encrypt type="x509v3"

```

3

```

  alias="alice"
  algorithm="aes-256"
  keyWrapAlgorithm="rsa_oaep"
  tokenReference="keyIdentifier" />
<requires>

```

4

```

  <signature/>
  <encryption/>
</requires>
</config>
</jboss-ws-security>

```

1	Keystore and Truststore information: location of each store, the password, and type of store.
2	Signature configuration: you must provide the certificate and key pair aliases to use. <i>includeTimestamp</i> specifies whether the timestamp is signed to prevent tampering.
3	Encryption configuration: you must provide the certificate and key pair aliases to use. Refer to <a href="#">Algorithms</a> for more information.
4	Optional security requirements: incoming messages must be both signed, and encrypted.

## Dynamic Encryption

When replying to multiple clients, a service provider must encrypt a message according to its destination using the correct public key. The JBossWS native implementation of WS-Security obtains the correct key to use from the signature received (and verified) in the incoming message.

### Example 10.6. Dynamic Encryption Configuration

To configure dynamic encryption:

```

<jboss-ws-security xmlns="http://www.jboss.com/ws-security/config"
  xmlns:xsi="http://www.w3.org/2001/XMLSchema-instance"
  xsi:schemaLocation="http://www.jboss.com/ws-security/config

```

```

    http://www.jboss.com/ws-security/schema/jboss-ws-
security_1_0.xsd">
    <key-store-file>WEB-INF/bob-sign_enc.jks</key-store-file>
    <key-store-password>password</key-store-password>
    <key-store-type>jks</key-store-type>
    <trust-store-file>WEB-INF/wsse10.truststore</trust-store-file>
    <trust-store-password>password</trust-store-password>

    <config>
    <timestamp ttl="300"/>
    <sign type="x509v3" alias="1" includeTimestamp="true"/>
    <encrypt type="x509v3"

1
        algorithm="aes-256"
        keyWrapAlgorithm="rsa_oaep"
        tokenReference="keyIdentifier" />
    <requires>
    <signature/>

2
        <encryption/>
    </requires>
    </config>
</jboss-ws-security>

```

1 Do not specify any encryption alias on the server side.

2 Declare that a signature is required.

## Algorithms

Asymmetric and symmetric encryption is performed whenever the `<encrypt>` element is declared. Message data are encrypted using a generated symmetric secured key. This key is written in the SOAP header after being encrypted (wrapped) with the receiver public key. You can set both the encryption and key wrap algorithms.

The supported encryption algorithms include:

- AES 128 (aes-128) (default)
- AES 192 (aes-192)
- AES 256 (aes-256)
- Triple DES (triple-des)

The supported key-wrap algorithms include:

- RSA v1.5 (rsa\_15) (default)
- RSA OAEP (rsa\_oaep)

**NOTE**

The [Unlimited Strength Java\(TM\) Cryptography Extension](#) installation might be required to run some strong algorithms (for example, aes-256). Your country may impose limitations on the allowed cryptographic strength in applications. It is your responsibility to select the encryption level suitable for your jurisdiction.

**Encryption Token Reference**

For interoperability reasons, you may need to configure the type of reference to encryption token to be used. For example, Microsoft Indigo does not support direct reference to local binary security tokens which are the default reference type used by JBossWS.

To configure this reference, you specify the *tokenReference* attribute in the <encrypt> element. The values for the *tokenReference* attribute are:

- **directReference** (default)
- **keyIdentifier** - specifies the token data by means of an X509 SubjectKeyIdentifier reference.
- **x509IssuerSerial** - uniquely identifies an end entity certificate by its X509 Issuer and Serial Number

**NOTE**

Complete information about X509 Token Profiles are available in the *WSS X501 Certificate Token Profile 1.0* document, which can be obtained from the [Oasis.org docs portal](#).

**Targets Configuration**

JBossWS gives you precise control over elements that must be signed or encrypted. This allows you to encrypt important data only (such as credit card numbers) instead of other, security-trivial, information exchanged by the same service (email addresses, for example). To configure this, you must specify the Qualified Name (qname) of the SOAP elements to encrypt. The default behavior is to encrypt the whole SOAP body.

```
<encrypt type="x509v3" alias="alice">
  <targets>
    <target type="qname">{http://www.my-company.com/cc}CardNumber</target>
    <target type="qname">{http://www.my-
company.com/cc}CardExpiration</target>
    <target type="qname" contentOnly="true">{http://www.my-
company.com/cc}CustomerData</target>
  </targets>
</encrypt>
```

**Payload Carriage Returns**

Signature verification errors can occur in signed message payloads that contain carriage returns (\r) due to the way the special character is parsed by XML parsers. To prevent this issue, you can choose to implement custom encoding before sending the payload. Users can either encrypt the message, or force JBossWS to perform canonical normalization of messages.

The `org.jboss.ws.DOMContentCanonicalNormalization` property can normalize the payload if set to `true` in the `MessageContext`. The property must be set just before the invocation on the client side and in the endpoint implementation.

### 10.21.2.7. JAAS Integration

The WS-Security implementation allows users to achieve J2EE declarative security through JAAS integration. The calling user's identity and credentials are derived from the `wsse` headers of the incoming message, according to the parameters provided in the server `wsse` configuration file. Authentication and authorization is subsequently achieved delegating to the JAAS login modules configured for the specified security domain.

#### Username Token

Username Token Profile provides a mean of specifying the caller's username and password. The `wsse` server configuration file can be used to have those information used when performing authentication and authorization through configured login module.

```
<jboss-ws-security xmlns="http://www.jboss.com/ws-security/config"
  xmlns:xsi="http://www.w3.org/2001/XMLSchema-instance"
  xsi:schemaLocation="http://www.jboss.com/ws-security/config
    http://www.jboss.com/ws-security/schema/jboss-ws-
security_1_0.xsd">
  <config>
    <username/>
    <authenticate>
      <usernameAuth/>
    </authenticate>
  </config>
</jboss-ws-security>
```

#### X.509 Certificate Token

In previous versions of JBossWS, the username token was always used to set the principal and credential of the caller whenever specified. This behavior is retained for backward compatibility reasons where no `<authenticate>` element is specified and the username token is used.

```
<jboss-ws-security xmlns="http://www.jboss.com/ws-security/config"
  xmlns:xsi="http://www.w3.org/2001/XMLSchema-instance"
  xsi:schemaLocation="http://www.jboss.com/ws-security/config
    http://www.jboss.com/ws-security/schema/jboss-ws-
security_1_0.xsd">
  <key-store-file>META-INF/bob-sign.jks</key-store-file>
  <key-store-password>password</key-store-password>
  <key-store-type>jks</key-store-type>
  <trust-store-file>META-INF/wsse10.truststore</trust-store-file>
  <trust-store-password>password</trust-store-password>
  <config>
    <sign type="x509v3" alias="1" includeTimestamp="false"/>
    <requires>
      <signature/>
    </requires>
    <authenticate>
      <signatureCertAuth
certificatePrincipal="org.jboss.security.auth.certs.SubjectCNMapping"/>
```

1

```

    </authenticate>
  </config>
</jboss-ws-security>

```

- The optional *certificatePrincipal* attribute specifies the class used to retrieve the principal from the X.509 certificate's attributes. The selected class must extend **CertificatePrincipal**. The default class used when no attribute is specified is **org.jboss.security.auth.certs.SubjectDNMapping**.

The configured security domain must have a correctly configured **BaseCertLoginModule**, as described in [Example 10.7, “BaseCertLoginModule Security Domain”](#).

### Example 10.7. BaseCertLoginModule Security Domain

The following code sample shows a security domain with a **CertRolesLoginModule** that also enables authorization (using the specified **jbossws-roles.properties** file).

```

<application-policy name="JBossWSCert">
  <authentication>
    <login-module
code="org.jboss.security.auth.spi.CertRolesLoginModule" flag="required">
      <module-option name="rolesProperties">jbossws-
roles.properties</module-option>
      <module-option name="unauthenticatedIdentity">anonymous</module-
option>
      <module-option
name="securityDomain">java:/jaas/JBossWSCert</module-option>
    </login-module>
  </authentication>
</application-policy>

```

The **BaseCertLoginModule** uses a central keystore to authenticate users. This store is configured through the **org.jboss.security.plugins.JaasSecurityDomain** MBean as shown in [Example 10.8, “BaseCertLoginModule Keystore”](#).

### Example 10.8. BaseCertLoginModule Keystore

```

<mbean code="org.jboss.security.plugins.JaasSecurityDomain"
name="jboss.security:service=SecurityDomain">
  <constructor>
    <arg type="java.lang.String" value="JBossWSCert"/>
  </constructor>
  <attribute name="KeyStoreURL">resource:META-
INF/keystore.jks</attribute>
  <attribute name="KeyStorePass">password</attribute>
  <depends>jboss.security:service=JaasSecurityManager</depends>
</mbean>

```

At authentication time, the specified `CertificatePrincipal` mapping class accesses the keystore using the principal obtained from the associated wsse header. If a certificate is found and is the same as the one specified in the wsse header, the user is successfully authenticated.

### 10.21.2.8. POJO Endpoint Authentication and Authorization

The credentials obtained by WS-Security are generally used for EJB endpoints, or for POJO endpoints when they make a call to another secured resource. It is now possible to enable authentication and authorization checking for POJO endpoints.



#### IMPORTANT

Authentication and Authorization should not be enabled for EJB based endpoints because the EJB container handles the security requirements of the deployed bean.

#### Procedure 10.1. Enabling POJO Authentication and Authorization

This procedure describes the additional configuration required to enable authentication and authorization for POJO endpoints.

##### 1. Define Security Domain in Web Archive

You must define a security domain in the WAR containing the POJO.

Specify a `<security-domain>` in the `jboss-web` deployment descriptor within the `/WEB-INF` folder.

```
<jboss-web>
  <security-domain>java:/jaas/JBossWS</security-domain>
</jboss-web>
```

##### 2. Configure the `jboss-wsse-server.xml` `<authorize>` element

Specify an `<authorize>` element within the `<config>` element.

The `<config>` element can be defined globally, be port-specific, or operation-specific.

The `<authorize>` element must contain either the `<unchecked/>` element or one or more `<role>` elements. Each `<role>` element must contain the name of a valid `RoleName`.

You can choose to implement two types of authentication: unchecked, and role-based authentication.

#### Unchecked Authentication

The authentication step is performed to validate the user's username and password, but no further role checking takes place. If the user's username and password are invalid, the request is rejected.

#### Example 10.9. Unchecked Authentication

```
<jboss-ws-security>
  <config>
    <authorize>
      <unchecked/>
    </authorize>
```



```

    </config>
</jboss-ws-security>

```

### Role-based Authentication

The user is authenticated using their username and password as per Unchecked Authentication. Once the user's username and password is verified, user credentials are checked again to ensure at least of the roles specified in the `<role>` element is assigned to the user.



#### NOTE

Authentication and authorization proceeds even if no username and password, or certificate was provided in the request message. In this scenario, authentication may proceed if the security domain's login module has been configured with an anonymous identity.

### Example 10.10. Role-based Authentication

```

<jboss-ws-security>
  <config>
    <authorize>
      <role>friend</role>
      <role>family</role>
    </authorize>
  </config>
</jboss-ws-security>

```

## 10.21.3. XML Registries

J2EE 5.0 mandates support for Java API for XML Registries (JAXR). Inclusion of a XML Registry with the J2EE 5.0 certified Application Server is optional. JBoss EAP ships a UDDI v2.0 compliant registry, the Apache jUDDI registry. JAXR Capability Level 0 (UDDI Registries) is also supported through Apache Scout integration.

[Section 10.21.3, “XML Registries”](#) describes how to configure the jUDDI registry in JBoss and some sample code outlines for using JAXR API to publish and query the jUDDI registry.

### 10.21.3.1. Apache jUDDI Configuration

jUDDI registry configuration happens via a MBean Service that is deployed in the `juddi-service.sar` archive in the `all` server profile. The configuration of this service can be done in the `jboss-service.xml` of the `META-INF` directory in the `juddi-service.sar`

Let us look at the individual configuration items that can be changed.

DataSources configuration

```
<!-- Datasource to Database -->
<attribute name="DataSourceUrl">java:/DefaultDS</attribute>
```

Database Tables (Should they be created on start, Should they be dropped on stop, Should they be dropped on start etc)

```
<!-- Should all tables be created on Start-->
<attribute name="CreateOnStart">false</attribute>
<!-- Should all tables be dropped on Stop-->
<attribute name="DropOnStop">true</attribute>
<!-- Should all tables be dropped on Start-->
<attribute name="DropOnStart">false</attribute>
```

JAXR Connection Factory to be bound in JNDI. (Should it be bound? and under what name?)

```
<!-- Should I bind a Context to which JaxrConnectionFactory bound-->
<attribute name="ShouldBindJaxr">true</attribute>

<!-- Context to which JaxrConnectionFactory to bind to. If you have remote
clients, please bind it to the global namespace(default behavior).
To just cater to clients running on the same VM as JBoss, change to
java:/JAXR -->
<attribute name="BindJaxr">JAXR</attribute>
```

Other common configuration:

Add authorized users to access the jUDDI registry. (Add a sql insert statement in a single line)

Look at the script META-INF/ddl/juddi\_data.ddl for more details. Example for a user 'jboss'

```
INSERT INTO PUBLISHER (PUBLISHER_ID,PUBLISHER_NAME,
EMAIL_ADDRESS,IS_ENABLED,IS_ADMIN)
VALUES ('jboss','JBoss User','jboss@xxx','true','true');
```

### 10.21.3.2. JBoss JAXR Configuration

In this section, we will discuss the configuration needed to run the JAXR API. The JAXR configuration relies on System properties passed to the JVM. The System properties that are needed are:

```
javax.xml.registry.ConnectionFactoryClass=org.apache.ws.scout.registry.
ConnectionFactoryImpl
jaxr.query.url=http://localhost:8080/juddi/inquiry
jaxr.publish.url=http://localhost:8080/juddi/publish
scout.proxy.transportClass=org.jboss.jaxr.scout.transport.SaaJTransport
```

Please remember to change the hostname from "localhost" to the hostname of the UDDI service/Server.

You can pass the System Properties to the JVM in the following ways:

- When the client code is running inside JBoss (maybe a servlet or an EJB). Then you will need to pass the System properties in the `run.sh` or `run.bat` scripts to the java process via the "`-D`" option.

- When the client code is running in an external JVM. Then you can pass the properties either as "-D" options to the java process or explicitly set them in the client code(not recommended).

```
System.setProperty(propertyname, propertyvalue);
```

### 10.21.3.3. JAXR Sample Code

There are two categories of API: JAXR Publish API and JAXR Inquiry API. The important JAXR interfaces that any JAXR client code will use are the following.

- [javax.xml.registry.RegistryService](#) From J2EE 5.0 JavaDoc: "This is the principal interface implemented by a JAXR provider. A registry client can get this interface from a Connection to a registry. It provides the methods that are used by the client to discover various capability specific interfaces implemented by the JAXR provider."
- [javax.xml.registry.BusinessLifeCycleManager](#) From J2EE 5.0 JavaDoc: "The **BusinessLifeCycleManager** interface, which is exposed by the Registry Service, implements the life cycle management functionality of the Registry as part of a business level API. There is no authentication information provided, because the Connection interface keeps that state and context on behalf of the client."
- [javax.xml.registry.BusinessQueryManager](#) From J2EE 5.0 JavaDoc: "The **BusinessQueryManager** interface, which is exposed by the Registry Service, implements the business style query interface. It is also referred to as the focused query interface."

Let us now look at some of the common programming tasks performed while using the JAXR API:

Getting a JAXR Connection to the registry.

```
String queryurl = System.getProperty("jaxr.query.url",
    "http://localhost:8080/juddi/inquiry");
String puburl = System.getProperty("jaxr.publish.url",
    "http://localhost:8080/juddi/publish");
..
Properties props = new Properties();
props.setProperty("javax.xml.registry.queryManagerURL", queryurl);
props.setProperty("javax.xml.registry.lifeCycleManagerURL", puburl);

String transportClass = System.getProperty("scout.proxy.transportClass",
    "org.jboss.jaxr.scout.transport.SaajTransport");
System.setProperty("scout.proxy.transportClass", transportClass);

// Create the connection, passing it the configuration properties
factory = ConnectionFactory.newInstance();
factory.setProperties(props);
connection = factory.createConnection();
```

Authentication with the registry.

```
/**
 * Does authentication with the uddi registry
 */
protected void login() throws JAXRException
{
    PasswordAuthentication passwdAuth = new PasswordAuthentication(userid,
```

```

passwd.toCharArray());
    Set creds = new HashSet();
    creds.add(passwdAuth);

    connection.setCredentials(creds);
}

```

### Save a Business

```

/**
 * Creates a Jaxr Organization with 1 or more services
 */
protected Organization createOrganization(String orname) throws
JAXRException
{
    Organization org = blm.createOrganization(getIString(orname));
    org.setDescription(getIString("JBoss Inc"));
    Service service = blm.createService(getIString("JBoss JAXR Service"));
    service.setDescription(getIString("Services of XML Registry"));
    //Create serviceBinding
    ServiceBinding serviceBinding = blm.createServiceBinding();
    serviceBinding.setDescription(blm.createInternationalString("Test
Service Binding"));

    //Turn validation of URI off
    serviceBinding.setValidateURI(false);
    serviceBinding.setAccessURI("http://testjboss.org");
    ...
    // Add the serviceBinding to the service
    service.addServiceBinding(serviceBinding);

    User user = blm.createUser();
    org.setPrimaryContact(user);
    PersonName personName = blm.createPersonName("Anil S");
    TelephoneNumber telephoneNumber = blm.createTelephoneNumber();
    telephoneNumber.setNumber("111-111-7777");
    telephoneNumber.setType(null);
    PostalAddress address = blm.createPostalAddress("111", "My Drive",
"BuckHead", "GA", "USA", "1111-111", "");
    Collection postalAddresses = new ArrayList();
    postalAddresses.add(address);
    Collection emailAddresses = new ArrayList();
    EmailAddress emailAddress = blm.createEmailAddress("anil@apache.org");
    emailAddresses.add(emailAddress);

    Collection numbers = new ArrayList();
    numbers.add(telephoneNumber);
    user.setPersonName(personName);
    user.setPostalAddresses(postalAddresses);
    user.setEmailAddresses(emailAddresses);
    user.setTelephoneNumbers(numbers);

    ClassificationScheme cScheme = getClassificationScheme("ntis-
gov:naics", "");
    Key cKey = blm.createKey("uuid:C0B9FE13-324F-413D-5A5B-2004DB8E5CC2");
    cScheme.setKey(cKey);
}

```

```

        Classification classification = blm.createClassification(cScheme,
"Computer Systems Design and Related Services", "5415");
        org.addClassification(classification);
        ClassificationScheme cScheme1 = getClassificationScheme("D-U-N-S", "");
        Key cKey1 = blm.createKey("uuid:3367C81E-FF1F-4D5A-B202-3EB13AD02423");
        cScheme1.setKey(cKey1);
        ExternalIdentifier ei = blm.createExternalIdentifier(cScheme1, "D-U-N-S
number", "08-146-6849");
        org.addExternalIdentifier(ei);
        org.addService(service);

        return org;
    }

```

### Query a Business

```

/**
 * Locale aware Search a business in the registry
 */
public void searchBusiness(String bizname) throws JAXRException
{
    try
    {
        // Get registry service and business query manager
        this.getJAXREssentials();

        // Define find qualifiers and name patterns
        Collection findQualifiers = new ArrayList();
        findQualifiers.add(FindQualifier.SORT_BY_NAME_ASC);
        Collection namePatterns = new ArrayList();
        String pattern = "%" + bizname + "%";
        LocalizedString ls = blm.createLocalizedString(Locale.getDefault(),
pattern);
        namePatterns.add(ls);

        // Find based upon qualifier type and values
        BulkResponse response = bqm.findOrganizations(findQualifiers,
namePatterns, null, null, null, null);

        // check how many organization we have matched
        Collection orgs = response.getCollection();
        if (orgs == null)
        {
            log.debug(" -- Matched 0 orgs");
        }
        else
        {
            log.debug(" -- Matched " + orgs.size() + " organizations -- ");

            // then step through them
            for (Iterator orgIter = orgs.iterator(); orgIter.hasNext();)
            {
                Organization org = (Organization)orgIter.next();
                log.debug("Org name: " + getName(org));
                log.debug("Org description: " + getDescription(org));
                log.debug("Org key id: " + getKey(org));
            }
        }
    }
}

```

```

        checkUser(org);
        checkServices(org);
    }
}
}
finally
{
    connection.close();
}
}

```

For more examples of code using the JAXR API, please refer to the resources in the Resources Section.

#### 10.21.3.4. Troubleshooting

- **I cannot connect to the registry from JAXR.** Please check the inquiry and publish url passed to the JAXR ConnectionFactory.
- **I cannot connect to the jUDDI registry.** Please check the jUDDI configuration and see if there are any errors in the server.log. And also remember that the jUDDI registry is available only in the "all" configuration.
- **I cannot authenticate to the jUDDI registry.** Have you added an authorized user to the jUDDI database, as described earlier in the chapter?
- **I would like to view the SOAP messages in transit between the client and the UDDI Registry.** Please use the tcpmon tool to view the messages in transit. [TCPMon](#)

#### 10.21.3.5. Resources

- [JAXR Tutorial and Code Camps](#)
- [J2EE 1.4 Tutorial](#)
- [J2EE Web Services by Richard Monson-Haefel](#)

## 10.22. JBOSSWS EXTENSIONS

This section describes proprietary JBoss extensions to JAX-WS.

### 10.22.1. Proprietary Annotations

For the set of standard annotations, please have a look at [JAX-WS Annotations](#)

#### 10.22.1.1. EndpointConfig

```

/**
 * Defines an endpoint or client configuration.
 * This annotation is valid on an endpoint implementaion bean or a SEI.
 */
@Retention(value = RetentionPolicy.RUNTIME)
@Target(value = { ElementType.TYPE })
public @interface EndpointConfig

```

```

{
    ...
    /**
     * The optional config-name element gives the configuration name that
     * must be present in
     * the configuration given by element config-file.
     *
     * Server side default: Standard Endpoint
     * Client side default: Standard Client
     */
    String configName() default "";
    ...
    /**
     * The optional config-file element is a URL or resource name for the
     * configuration.
     *
     * Server side default: standard-jaxws-endpoint-config.xml
     * Client side default: standard-jaxws-client-config.xml
     */
    String configFile() default "";
}

```

### 10.22.1.2. WebContext

```

/**
 * Provides web context specific meta data to EJB based web service
 * endpoints.
 *
 * @author thomas.diesler@jboss.org
 * @since 26-Apr-2005
 */
@Retention(value = RetentionPolicy.RUNTIME)
@Target(value = { ElementType.TYPE })
public @interface WebContext
{
    ...
    /**
     * The contextRoot element specifies the context root that the web
     * service endpoint is deployed to.
     * If it is not specified it will be derived from the deployment short
     * name.
     *
     * Applies to server side port components only.
     */
    String contextRoot() default "";
    ...
    /**
     * The virtual hosts that the web service endpoint is deployed to.
     *
     * Applies to server side port components only.
     */
    String[] virtualHosts() default {};

    /**
     * Relative path that is appended to the contextRoot to form fully

```

```

qualified
    * endpoint address for the web service endpoint.
    *
    * Applies to server side port components only.
    */
String urlPattern() default "";

/**
 * The authMethod is used to configure the authentication mechanism for
the web service.
 * As a prerequisite to gaining access to any web service which are
protected by an authorization
 * constraint, a user must have authenticated using the configured
mechanism.
 *
 * Legal values for this element are "BASIC", or "CLIENT-CERT".
 */
String authMethod() default "";

/**
 * The transportGuarantee specifies that the communication
 * between client and server should be NONE, INTEGRAL, or
 * CONFIDENTIAL. NONE means that the application does not require any
 * transport guarantees. A value of INTEGRAL means that the application
 * requires that the data sent between the client and server be sent in
 * such a way that it can not be changed in transit. CONFIDENTIAL means
 * that the application requires that the data be transmitted in a
 * fashion that prevents other entities from observing the contents of
 * the transmission. In most cases, the presence of the INTEGRAL or
 * CONFIDENTIAL flag will indicate that the use of SSL is required.
 */
String transportGuarantee() default "";

/**
 * A secure endpoint does not by default publish it's wsdl on an
unsecure transport.
 * You can override this behavior by explicitly setting the
secureWSDLAccess flag to false.
 *
 * Protect access to WSDL. See http://jira.jboss.org/jira/browse/JBWS-723
 */
boolean secureWSDLAccess() default true;
}

```

### 10.22.1.3. SecurityDomain

```

/**
 * Annotation for specifying the JBoss security domain for an EJB
 */
@Target(ElementType.TYPE) @Retention(RetentionPolicy.RUNTIME)
public @interface SecurityDomain
{
    /**
     * The required name for the security domain.

```



```
*
* Do not use the JNDI name
*
* Good: "MyDomain"
* Bad: "java:/jaas/MyDomain"
*/
String value();

/**
 * The name for the unauthenticated principal
 */
String unauthenticatedPrincipal() default "";
}
```

## 10.23. WEB SERVICES APPENDIX



### NOTE

This information can be used with JBoss Web Services CXF Stack.

[JAX-WS Endpoint Configuration](#)

[JAX-WS Client Configuration](#)

[JAX-WS Annotations](#)

## 10.24. REFERENCES

1. [JSR-224 - Java API for XML-Based Web Services \(JAX-WS\) 2.0](#)
2. [JSR 222 - Java Architecture for XML Binding \(JAXB\) 2.0](#)
3. [JSR-250 - Common Annotations for the Java Platform](#)
4. [JSR 181 - Web Services Metadata for the Java Platform](#)

## CHAPTER 11. ADDITIONAL SERVICES

This chapter discusses useful MBean services that are not discussed elsewhere either because they are utility services not necessary for running JBoss, or they don't fit into a current section of the book.

### 11.1. EXPOSING MBEAN EVENTS VIA SNMP

JBoss has an SNMP adaptor service that can be used to intercept JMX notifications emitted by MBeans, convert them to traps and send them to SNMP managers. In this respect the `snmp-adaptor` acts as a SNMP agent. Future versions may offer support for full agent get/set functionality that maps onto MBean attributes or operations.

This service can be used to integrate JBoss with higher order system or network management platforms (HP OpenView, for example), making the MBeans visible to those systems. The MBean developer can instrument the MBeans by producing notifications for any significant event (server coldstart, for example), and the adaptor can then be configured to intercept the notification and map it onto an SNMP traps. The adaptor uses the `JoeSNMP` package from OpenNMS as the SNMP engine.

The SNMP service is configured in `snmp-adaptor.sar`. This service is only available in the `all` configuration, so you will need to copy the `.sar` file to your configuration if you want to use the service from another profile.

Inside the `snmp-adaptor.sar` directory, there are two configuration files that control the SNMP service.

#### `managers.xml`

This file configures where to send traps. The content model for this file is shown in [Figure 11.1, “The schema for the SNMP managers file”](#).

#### `notifications.xml`

This file specifies the exact mapping of each notification type to a corresponding SNMP trap. The content model for this file is shown in [Figure 11.2, “The schema for the notification to trap mapping file”](#).

The `SNMPAgentService` MBean is configured in `snmp-adaptor.sar/META-INF/jboss-service.xml`.

The configurable parameters are:

**Table 11.1.**

Parameter	Description
<code>HeartBeatPeriod</code>	The period in seconds at which heartbeat notifications are generated.
<code>ManagersResName</code>	Specifies the resource name of the <code>managers.xml</code> file.
<code>NotificationMapResName</code>	Specifies the resource name of the <code>notifications.xml</code> file.

Parameter	Description
TrapFactoryClassName	The <code>org.jboss.jmx.adaptor.snmp.agent.TrapFactory</code> implementation class that takes care of translation of JMX Notifications into SNMP V1 and V2 traps.
TimerName	Specifies the JMX ObjectName of the JMX timer service to use for heartbeat notifications.
SubscriptionList	Specifies which MBeans and notifications to listen for.

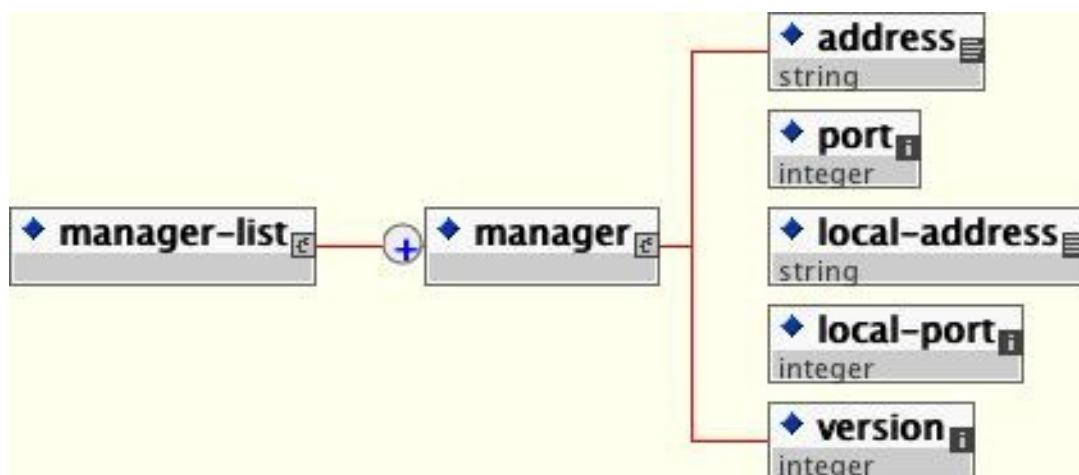

Figure 11.1. The schema for the SNMP managers file

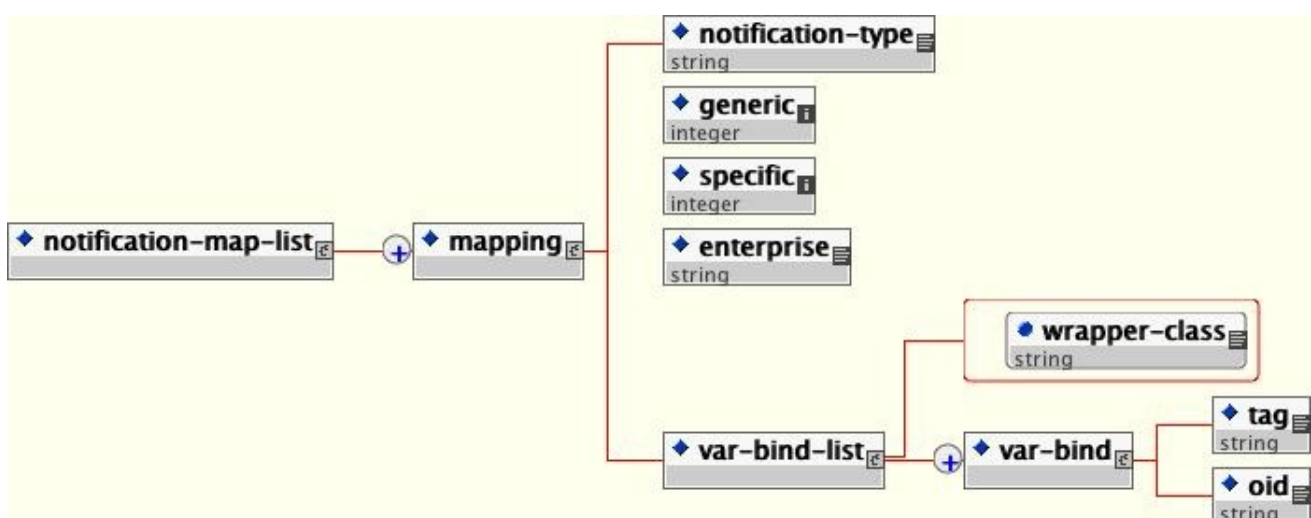

Figure 11.2. The schema for the notification to trap mapping file

`TrapdService` is a simple MBean that acts as an SNMP Manager. It listens to a configurable port for incoming traps and logs them as DEBUG messages using the system logger. You can modify the log4j configuration to redirect the log output to a file. `SnmAgentService` and `TrapdService` are not dependent on each other.

## CHAPTER 12. JBOSS AOP

JBoss AOP is a 100% Pure Java Aspected Oriented Framework usable in any programming environment or tightly integrated with our application server. Aspects allow you to more easily modularize your code base when regular object oriented programming just does not fit the bill. It can provide a cleaner separation from application logic and system code. It provides a great way to expose integration points into your software. Combined with Java Annotations, it also is a great way to expand the Java language in a clean pluggable way rather than using annotations solely for code generation.

JBoss AOP is not only a framework, but also a prepackaged set of aspects that are applied via annotations, pointcut expressions, or dynamically at runtime. Some of these include caching, asynchronous communication, transactions, security, remoting, and many more.

An aspect is a common feature that is typically scattered across methods, classes, object hierarchies, or even entire object models. It is behavior that looks and smells like it should have structure, but you can not find a way to express this structure in code with traditional object-oriented techniques.

For example, metrics is one common aspect. To generate useful logs from your application, you have to (often liberally) sprinkle informative messages throughout your code. However, metrics is something that your class or object model really should not be concerned about. After all, metrics is irrelevant to your actual application: it does not represent a customer or an account, and it does not realize a business rule. It's simply orthogonal.

### 12.1. SOME KEY TERMS

#### Joinpoint

A *joinpoint* is any point in your Java program. The call of a method, the execution of a constructor, the access of a field; all these are joinpoints. You could also think of a joinpoint as a particular Java event, where an event is a method call, constructor call, field access, etc.

#### Invocation

An *invocation* is a JBoss AOP class that encapsulates what a joinpoint is at runtime. It could contain information like which method is being called, the arguments of the method, etc.

#### Advice

An *advice* is a method that is called when a particular joinpoint is executed, such as the behavior that is triggered when a method is called. It could also be thought of as the code that performs the interception. Another analogy is that an advice is an "event handler".

#### Pointcut

*Pointcuts* are AOP's expression language. Just as a regular expression matches strings, a pointcut expression matches a particular joinpoint.

#### Introduction

An *introduction* modifies the type and structure of a Java class. It can be used to force an existing class to implement an interface or to add an annotation to anything.

#### Aspect

An *aspect* is a plain Java class that encapsulates any number of advices, pointcut definitions, mixins, or any other JBoss AOP construct.

#### Interceptor

An *interceptor* is an aspect with only one advice, named `invoke`. It is a specific interface that you can implement if you want your code to be checked by forcing your class to implement an interface. It also will be portable and can be reused in other JBoss environments like EJBs and JMX MBeans.

In AOP, a feature like metrics is called a *crosscutting concern*, as it is a behavior that "cuts" across multiple points in your object models, yet is distinctly different. As a development methodology, AOP recommends that you abstract and encapsulate crosscutting concerns.

For example, let us say you wanted to add code to an application to measure the amount of time it would take to invoke a particular method. In plain Java, the code would look something like the following.

```
public class BankAccountDAO
{
    public void withdraw(double amount)
    {
        long startTime = System.currentTimeMillis();
        try
        {
            // Actual method body...
        }
        finally
        {
            long endTime = System.currentTimeMillis() - startTime;
            System.out.println("withdraw took: " + endTime);
        }
    }
}
```

While this code works, there are a few problems with this approach:

1. It's extremely difficult to turn metrics on and off, as you have to manually add the code in the `try/finally` blocks to each and every method or constructor you want to benchmark.
2. Profiling code should not be combined with your application code. It makes your code more verbose and difficult to read, since the timings must be enclosed within the `try/finally` blocks.
3. If you wanted to expand this functionality to include a method or failure count, or even to register these statistics to a more sophisticated reporting mechanism, you'd have to modify a lot of different files (again).

This approach to metrics is very difficult to maintain, expand, and extend, because it is dispersed throughout your entire code base. In many cases, OOP may not always be the best way to add metrics to a class.

Aspect-oriented programming gives you a way to encapsulate this type of behavior functionality. It allows you to add behavior such as metrics "around" your code. For example, AOP provides you with programmatic control to specify that you want calls to `BankAccountDAO` to go through a metrics aspect before executing the actual body of that code.

## 12.2. CREATING ASPECTS IN JBOSS AOP

In short, all AOP frameworks define two things: a way to implement crosscutting concerns, and a programmatic construct – a programming language or a set of tags to specify how you want to apply those snippets of code. Let us take a look at how JBoss AOP, its cross-cutting concerns, and how you

can implement a metrics aspect in JBoss Enterprise Application Platform.

The first step in creating a metrics aspect in JBoss AOP is to encapsulate the metrics feature in its own Java class. The following code extracts the `try/finally` block in our first code example's `BankAccountDAO.withdraw()` method into `Metrics`, an implementation of a JBoss AOP Interceptor class.

The following example code demonstrates implementing metrics in a JBoss AOP Interceptor

```
01. public class Metrics implements org.jboss.aop.advice.Interceptor
02. {
03.     public Object invoke(Invocation invocation) throws Throwable
04.     {
05.         long startTime = System.currentTimeMillis();
06.         try
07.         {
08.             return invocation.invokeNext();
09.         }
10.         finally
11.         {
12.             long endTime = System.currentTimeMillis() - startTime;
13.             java.lang.reflect.Method m =
((MethodInvocation)invocation).method;
14.             System.out.println("method " + m.toString() + " time: " +
endTime + "ms");
15.         }
16.     }
17. }
```

Under JBoss AOP, the `Metrics` class wraps `withdraw()`: when calling code invokes `withdraw()`, the AOP framework breaks the method call into its parts and encapsulates those parts into an `Invocation` object. The framework then calls any aspects that sit between the calling code and the actual method body.

When the AOP framework is done dissecting the method call, it calls `Metrics`'s `invoke` method at line 3. Line 8 wraps and delegates to the actual method and uses an enclosing `try/finally` block to perform the timings. Line 13 obtains contextual information about the method call from the `Invocation` object, while line 14 displays the method name and the calculated metrics.

Having the `Metrics` code within its own object allows us to easily expand and capture additional measurements later on. Now that metrics are encapsulated into an aspect, let us see how to apply it.

## 12.3. APPLYING ASPECTS IN JBOSS AOP

To apply an aspect, you define when to execute the aspect code. Those points in execution are called *pointcuts*. An analogy to a pointcut is a regular expression. Where a regular expression matches strings, a pointcut expression matches events or *points* within your application. For example, a valid pointcut definition would be, "for all calls to the JDBC method `executeQuery()`, call the aspect that verifies SQL syntax."

An entry point could be a field access, or a method or constructor call. An event could be an exception being thrown. Some AOP implementations use languages akin to queries to specify pointcuts. Others use tags. JBoss AOP uses both.

The following listing demonstrates defining a pointcut for the `Metrics` example in JBoss AOP:

```
<interceptor name="SimpleInterceptor" class="com.mc.Metrics"/>
```

1

```
<bind pointcut="execution (public void com.mc.BankAccountDAO-
>withdraw(double amount))" >
```

2

```
    <interceptor-ref name="SimpleInterceptor" />
</bind>
```

2

```
<bind pointcut="execution (* com.mc.billing.->(..))">
```

3

```
    <interceptor-ref name="com.mc.Metrics" />
</bind>
```

3

1	Defines the mapping of the interceptor name to the <b>interceptor</b> class.
2	Lines 2-4 define a pointcut that applies the <b>metrics</b> aspect to the specific method <b>BankAccountDAO.withdraw()</b> .
3	Lines 5-7 define a general pointcut that applies the <b>metrics</b> aspect to all methods in all classes in the <b>com.mc.billing</b> package. There is also an optional annotation mapping if you prefer to avoid XML.

For more information, see the JBoss AOP reference documentation.

JBoss AOP has a rich set of pointcut expressions that you can use to define various points or events in your Java application. Once your points are defined, you can apply aspects to them. You can attach your aspects to a specific Java class in your application or you can use more complex compositional pointcuts to specify a wide range of classes within one expression.

With AOP, as this example shows, you can combine all crosscutting behavior into one object and apply it easily and simply, without complicating your code with features unrelated to business logic. Instead, common crosscutting concerns can be maintained and extended in one place.

Note that code within the **BankAccountDAO** class does not detect that it is being profiled. Profiling is part of what aspect-oriented programmers deem orthogonal concerns. In the object-oriented programming code snippet at the beginning of this chapter, profiling was part of the application code. AOP allows you to remove that code. A modern promise of middleware is transparency, and AOP clearly delivers.

Orthogonal behavior can also be included after development. In object-oriented code, monitoring and profiling must be added at development time. With AOP, a developer or an administrator can easily add monitoring and metrics as needed without touching the code. This is a very subtle but significant part of AOP, as this separation allows aspects to be layered on top of or below the code that they cut across. A layered design allows features to be added or removed at will. For instance, perhaps you snap on metrics only when you are doing some benchmarks, but remove it for production. With AOP, this can be done without editing, recompiling, or repackaging the code.

## 12.4. PACKAGING AOP APPLICATIONS

To deploy an AOP application in JBoss Enterprise Application Platform you need to package it. AOP is packaged similarly to SARs (MBeans). You can either deploy an XML file directly in the `deploy/` directory with the signature `*-aop.xml` along with your package (this is how the `base-aop.xml`, included in the `jboss-aop.deployer` file works) or you can include it in the JAR file containing your classes. If you include your XML file in your JAR, it must have the file extension `.aop` and a `jboss-aop.xml` file must be contained in a `META-INF` directory, for instance: `META-INF/jboss-aop.xml`.

In the JBoss Enterprise Application Platform 5, you *must* specify the schema used, otherwise your information will not be parsed correctly. You do this by adding the `xmlns="urn:jboss:aop-beans:1:0"` attribute to the root `aop` element, as shown here:

```
<aop xmlns="urn:jboss:aop-beans:1.0">
</aop>
```

If you want to create anything more than a non-trivial example, using the `.aop` JAR files, you can make any top-level deployment contain an AOP file containing the XML binding configuration. For instance you can have an AOP file in an EAR file, or an AOP file in a WAR file. The bindings specified in the `META-INF/jboss-aop.xml` file contained in the AOP file will affect all the classes in the whole WAR file.

To pick up an AOP file in an EAR file, it must be listed in the `.ear/META-INF/application.xml` as a Java module, as follows:

```
<?xml version='1.0' encoding='UTF-8'?>
<!DOCTYPE application PUBLIC "-//Sun Microsystems, Inc.//DTD J2EE
Application 1.2//EN" 'http://java.sun.com/j2ee/dtds/application_1_2.dtd'>

<application>
  <display-name>AOP in JBoss example</display-name>
  <module>
    <java>example.aop</java>
  </module>
  <module>
    <ejb>aopexampleejb.jar</ejb>
  </module>
  <module>
    <web>
      <web-uri>aopexample.war</web-uri>
      <context-root>/aopexample</context-root>
    </web>
  </module>
</application>
```



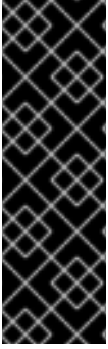

## IMPORTANT

In the JBoss Enterprise Application Platform 5, the contents of the `.ear` file are deployed in the order they are listed in the `application.xml`. When using loadtime weaving the bindings listed in the `example.aop` file must be deployed before the classes being advised are deployed, so that the bindings exist in the system before (for example) the `ejb` and `servlet` classes are loaded. This is achieved by listing the AOP file at the start of the `application.xml`. Other types of archives are deployed before anything else and so do not require special consideration, such as `.sar` and `.war` files.

## 12.5. THE JBOSS ASPECTMANAGER SERVICE

The `AspectManager` Service can be managed at runtime using the JMX console, which is found at `http://localhost:8080/jmx-console`. It is registered under the ObjectName `jboss.aop:service=AspectManager`. If you want to configure it on start up you need to edit some configuration files.

In JBoss Enterprise Application Platform 5 the `AspectManager` Service is configured using a JBoss Microcontainer bean. The configuration file is `jboss-as/server/PROFILE/conf/bootstrap/aop.xml`. The `AspectManager` Service is deployed with the following XML:

```
<bean name="AspectManager"
class="org.jboss.aop.deployers.AspectManagerJDK5">

  <property name="jbossIntegration"><inject
bean="AOPJBossIntegration"/></property>

  <property name="enableLoadtimeWeaving">>false</property>
  <!-- only relevant when EnableLoadtimeWeaving is true.
When transformer is on, every loaded class gets transformed.
If AOP can not find the class, then it throws an exception.
Sometimes, classes may not have all the classes they reference.
So, the Suppressing is needed. (For instance, JBoss cache in the
default configuration) -->

  <property name="suppressTransformationErrors">>true</property>

  <property name="prune">>true</property>

  <property name="include">org.jboss.test.,
org.jboss.injbossaop.</property>

  <property name="exclude">org.jboss.</property>
  <!-- This avoids instrumentation of hibernate cglib enhanced proxies

  <property name="ignore">*$$EnhancerByCGLIB$$*</property> -->

  <property name="optimized">>true</property>

  <property name="verbose">>false</property>
  <!-- Available choices for this attribute are:
org.jboss.aop.instrument.ClassicInstrumentor (default)
org.jboss.aop.instrument.GeneratedAdvisorInstrumentor -->
```

```

    <!-- <property
name="instrumentor">org.jboss.aop.instrument.ClassicInstrumentor</property
-->

    <!-- By default the deployment of the aspects contained in
../deployers/jboss-aop-jboss5.deployer/base-aspects.xml
are not deployed. To turn on deployment uncomment this property
<property name="useBaseXml">>true</property-->
</bean>

```

Later we will talk about changing the class of the `AspectManager` Service. To do this, replace the contents of the `class` attribute of the `bean` element.

## 12.6. LOADTIME TRANSFORMATION IN THE JBOSS ENTERPRISE APPLICATION PLATFORM USING SUN JDK

The JBoss Enterprise Application Platform has special integration with JDK to do loadtime transformations. This section explains how to use it.

If you want to do load-time transformations with JBoss Enterprise Application Platform 5 and Sun JDK, these are the steps you must take.

- Set the `enableLoadtimeWeaving` attribute/property to `true`. By default, JBoss Enterprise Application Platform will not do load-time bytecode manipulation of AOP files unless this is set. If `suppressTransformationErrors` is `true`, failed bytecode transformation will only give an error warning. This flag is needed because sometimes a JBoss deployment will not include all of the classes referenced.
- Copy the `pluggable-instrumentor.jar` from the `lib/` directory of your JBoss AOP distribution to the `bin/` directory of your JBoss Enterprise Application Platform.
- Next edit `run.sh` or `run.bat` (depending on what OS you are on) and add the following to the `JAVA_OPTS` environment variable:

```
set JAVA_OPTS=%JAVA_OPTS% -Dprogram.name=%PROGNAME% -
javaagent:pluggable-instrumentor.jar
```



### IMPORTANT

The class of the `AspectManager` Service must be `org.jboss.aop.deployers.AspectManagerJDK5` or `org.jboss.aop.deployment.AspectManagerServiceJDK5` as these are what work with the `-javaagent` option.

## 12.7. JROCKIT

JRockit also supports the `-javaagent` switch mentioned in [Section 12.6, “Loadtime transformation in the JBoss Enterprise Application Platform Using Sun JDK”](#). If you wish to use that, then the steps in [Section 12.6, “Loadtime transformation in the JBoss Enterprise Application Platform Using Sun JDK”](#) are sufficient. However, JRockit also comes with its own framework for intercepting when classes are loaded, which might be faster than the `-javaagent` switch. If you want to do load-time transformations using the special JRockit hooks, these are the steps you must take.

- Set the `enableLoadtimeWeaving` attribute/property to true. By default, JBoss Enterprise Application Platform will not do load-time bytecode manipulation of AOP files unless this is set. If `suppressTransformationErrors` is true, failed bytecode transformation will only give an error warning. This flag is needed because sometimes a JBoss deployment will not include all the classes referenced.
- Copy the `jrookit-pluggable-instrumentor.jar` from the `lib/` directory of your JBoss AOP distribution to the `bin/` directory of your the JBoss Enterprise Application Platform installation.
- Next edit `run.sh` or `run.bat` (depending on what OS you are on) and add the following to the `JAVA_OPTS` and `JBOSS_CLASSPATH` environment variables:

```
# Setup JBoss specific properties

JAVA_OPTS="$JAVA_OPTS -Dprogram.name=$PROGNAME \
-
Xmanagement: class=org.jboss.aop.hook.JRokitPluggableClassPreProcessor"

JBOSS_CLASSPATH="$JBOSS_CLASSPATH:jrookit-pluggable-
instrumentor.jar"
```

- Set the class of the `AspectManager` Service to `org.jboss.aop.deployers.AspectManagerJRokit` on JBoss Enterprise Application Platform 5, or `org.jboss.aop.deployment.AspectManagerService` as these are what work with special hooks in JRokit.

## 12.8. IMPROVING LOADTIME PERFORMANCE IN THE JBOSS ENTERPRISE APPLICATION PLATFORM ENVIRONMENT

The same rules apply to the JBoss Enterprise Application Platform for tuning loadtime weaving performance as standalone Java. Switches such as pruning, optimized, include and exclude are configured through the `jboss-5.x.x.GA/server/xxx/conf/aop.xml` file talked about earlier in this chapter.

## 12.9. SCOPING THE AOP TO THE CLASSLOADER

By default all deployments in JBoss are global to the whole application server. That means that any EAR, SAR, or JAR (for example), that is put in the deploy directory can see the classes from any other deployed archive. Similarly, AOP bindings are global to the whole virtual machine. This *global* visibility can be turned off per top-level deployment.

### 12.9.1. Deploying as part of a scoped classloader

The following process may change in future versions of JBoss AOP. If you deploy an AOP file as part of a scoped archive, the bindings (for instance) applied within the `.aop/META-INF/jboss-aop.xml` file will only apply to the classes within the scoped archive and not to anything else in the application server. Another alternative is to deploy `-aop.xml` files as part of a service archive (SAR). Again, if the SAR is scoped, the bindings contained in the `-aop.xml` files will only apply to the contents of the SAR file. It is not currently possible to deploy a standalone `-aop.xml` file and have that attach to a scoped deployment. Standalone `-aop.xml` files will apply to classes in the whole application server.

## 12.9.2. Attaching to a scoped deployment

If you have an application that uses classloader isolation, as long as you have prepared your classes, you can later attach an AOP file to that deployment. If we have an EAR file scoped using a `jboss-app.xml` file, with the scoped loader repository `jboss.test:service=scoped`:

```
<jboss-app>
  <loader-repository>
    jboss.test:service=scoped
  </loader-repository>
</jboss-app>
```

We can later deploy an AOP file containing aspects and configuration to attach that deployment to the scoped EAR. This is done using the `loader-repository` tag in the AOP file's `META-INF/jboss-aop.xml` file.

```
<?xml version="1.0" encoding="UTF-8"?>
<aop>
  <loader-repository>jboss.test:service=scoped</loader-repository>

  <!-- Aspects and bindings -->
</aop>
```

This has the same effect as deploying the AOP file as part of the EAR as we saw previously, but allows you to hot deploy aspects into your scoped application.

## CHAPTER 13. TRANSACTION MANAGEMENT

This chapter presents a brief overview of the main configuration options for the JBoss Transaction Service. For more information, please refer to the *JBoss Transactions Administration Guide*.

### 13.1. OVERVIEW

Transaction support in JBoss Enterprise Application Platform is provided by JBoss Transaction Service, a mature, modular, standards based, highly configurable transaction manager. By default, the server runs with the local-only JTA module of JBoss Transaction Service installed. This module provides an implementation of the standard JTA API for use by other internal components, such as the EJB container, as well as direct use by applications. It is suitable for coordinating ACID transactions that involve one or more XA Resource managers, such as relational databases or message queues.

Two additional, optional, JBoss Transaction Service transaction modules are also shipped with JBoss Enterprise Application Platform and may be deployed to provide additional functionality if required.

#### JBoss Transaction Service JTS

A Transaction Manager capable of distributing transaction context on remote IIOp method calls, creating a single distributed transaction which spans multiple Java Virtual Machines. This is useful for large-scale applications that span multiple servers, or for standards based interoperability with transactional business logic running in CORBA based systems. The functionality of this module can be accessed through the standard JTA API. In this way, it is a drop-in replacement and does not require changes to transactional business logic. To enable it, refer to [Section 13.8, “Using the JTS Module”](#) for more information.

#### JBoss Transaction Service XTS

A Transaction Manager, based on XML, which implements the *WS-AtomicTransaction (WS-AT)* and *WS-BusinessActivity (WS-BA)* specifications. This additional module uses core transaction support provided by the JTA or JTS managers, along with web services functionality provided by JBossWS Native. It is deployed into the server as an application. Applications may use WS-AT to provide standards based, distributed ACID transactions in a manner similar to JTS but using a Web Services transport, instead of CORBA. The WS-BA implementation compliments this by providing an alternative, compensation-based transaction model, well suited to coordinating long-running, loosely coupled business processes. XTS also implements a *WS-Coordination (WS-C)* service which is usually accessed internally by the local WS-AT and WS-BA implementations. However, this WS-C service can also be used to provide remote coordination for WS-AT and WS-BA transactions created in other server instances or non-JBoss containers. Refer to the JBoss Transactions Web Services Programmer's Guide for more details. To enable XTS, refer to [Section 13.9, “Using the XTS Module”](#).

### 13.2. CONFIGURATION ESSENTIALS

Configuration of the default JBossTS JTA is managed through a combination of the transaction manager's own properties file and the application server's deployment configuration. The configuration file resides at `<JBOSS_HOME>/server/<PROFILE>/conf/jbossts-properties.xml`. It contains defaults for the most commonly used properties. Many more are detailed in the accompanying JBoss Transaction Service Administration Guide. Each setting has a hard-coded default, but the system may not function properly if a configuration file does not exist. Additional configuration is also possible as part of the Microcontainer beans configuration found in the `<JBOSS_HOME>/server/<PROFILE>/deploy/transaction-jboss-beans.xml` file. This ties the transaction manager into the overall server profile, overriding the transaction configuration file settings with values specific to the application server where appropriate. In particular, it uses the

Service Binding Manager to set port binding information, as well as overriding selected other properties. Configuration properties are read by the Transaction Service at server initialization, and the server must be restarted to incorporate any changes made to the configuration files.

**Table 13.1. Most Critical Properties for JBoss Transaction Service**

Property Name	Default Value	Description
transactionTimeout	300 seconds	<p>the default time, in seconds, after which a transaction will time out and be rolled back by. Adjust this to suit your environment and workload.</p> <p>It may come as a surprise that transactions are processed asynchronously. This was a design decision, and needs to be accounted for by your code.</p>
objectStoreDir		<p>The directory where transaction data is logged. The transaction log is required to complete transactions in the case of system failure, and needs to be on reliable storage. Normally one file is generated per transaction, and each file is a few kilobytes in size. These are distributed over a directory tree for optimal performance. If a RAID controller is used, it should be configured for write through cache, in much the same manner as database storage devices. Writing of the transaction log is automatically skipped in the case of transactions that are rolling back or contain only a single resource.</p>
max-pool-size		<p>The Java EE Connector Architecture container keeps a dedicated physical connection open against the EIS where recovery is performed. Therefore, set the <b>max-pool-size</b> to the maximum number of connection possible minus 1.</p>

**Table 13.2. Additional Properties for JBoss Transaction Service**

Property Name	Default Value	Description
---------------	---------------	-------------

Property Name	Default Value	Description
com.arjuna.common.util.logging.DebugLevel	<b>0x00000000</b> , which equates to no logging	<p>determines the internal log threshold for the transaction manager codebase. It is independent of the overall server's <b>log4j</b> logging configuration, and acts to suppress extraneous log entries from being printed. When the default value is active, INFO and WARN messages are still printed, and this setting provides optimal performance. <b>0xffffffff</b> enables full debug logging. This setting results in large log files.</p> <p>Log messages that pass the internal <b>DebugLevel</b> check are passed to the server's logging system for further processing. In theory, full debugging may be left on and <b>log4j</b> can be used to turn logging on or off, but in reality this has a performance impact.</p>
com.arjuna.ats.arjuna.coordinator.commitOnePhase	<b>YES</b>	<p>Determines whether the transaction manager automatically applies the one-phase commit optimization to the transaction completion protocol, when only a single resource is registered with the transaction. Enabled by default to prevent writing transaction logs needlessly.</p>
com.arjuna.ats.arjuna.objectstore.transactionSync	<b>ON</b>	<p>Controls the flushing of transaction logs to disk during transaction termination. The default value results in a <b>FileDescriptor.sync</b> call for each committing transaction. This behavior is required to provide recovery and ACID properties. If these features are unimportant to the application in question, you can achieve better performance by disabling this property. This is discouraged, since it is usually better to write such applications in a way that avoids using transactions at all.</p>

Property Name	Default Value	Description
com.arjuna.ats.arjuna.xa.nodeldentifier  com.arjuna.ats.jta.xaRecoveryNode		These properties determine the behavior of the transaction recovery system. They must be configured correctly to ensure that transactions are resolved correctly so that recovery can happen if the server crashes. Please refer to the Recovery chapter of the JBoss Transactions Administration Guide for more details.
com.arjuna.ats.arjuna.coordinator.enableStatistics	<b>NO</b>	Enables gathering of transaction statistics. The statistics can be viewed using methods on the <b>TransactionManagerService</b> bean or its corresponding JMX MBean. Disabled by default.

### 13.3. TRANSACTIONAL RESOURCES

The Transaction Service coordinates transaction state updates using **XAResource** implementations, which are provided by the various resource managers. Resource managers may include databases, message queues or third-party JCA resource adapters. The list of databases and JDBC drivers which have been certified on JBoss Enterprise Application Platform is located at <http://www.jboss.com/products/platforms/application/supportedconfigurations/>. Most standards-compliant JDBC drivers should function correctly, but you should perform extensive testing when using an uncertified configuration, since interpretations of the XA specifications differ from one vendor to another.

Database connection pools are configured via the application server's Datasource files, which are files named like `-ds.xml`. Datasources which use the `<xa-datasource>` property automatically interact with the transaction manager. Connections obtained by looking up such datasource in JNDI and calling `getConnection` automatically participate in ongoing transactions. This is the preferred use case when transactional guarantees for data access are required.

If you are using a database which cannot support XA transactions, you can deploy a connection pool using `<local-xa-datasource>`. This type of datasource participates in the managed transaction using the [Section 13.4, “Last Resource Commit Optimization \(LRCO\)”](#), providing more limited transactional guarantees. Connections obtained from a `<no-tx-datasource>` do not interact with the transaction manager, and any work done on such connections must be explicitly committed or rolled back by the application, using the JDBC API.

Many databases require additional configuration before they can function as XA resource managers. Vendor-specific information for configuring databases is presented in [Appendix B, Vendor-Specific Datasource Definitions](#). Refer to your database administrator and the documentation which ships with your database for additional configuration directives. In addition, please consult the JBoss Transactions Administration Guide for information on setting up XA recovery properly.

JBoss Messaging provides an XA-aware driver and can participate in XA transactions. Please consult the JBoss Messaging User Guide for more details.



## 13.4. LAST RESOURCE COMMIT OPTIMIZATION (LRCO)

Although the XA transaction protocol is designed to provide ACID properties by using a two-phase commit protocol, model may not always be appropriate. Sometimes it is necessary to allow a non-XA-aware resource manager to participate in a transaction. This is often the case with data stores that do not support distributed transactions.

In this situation, you can use a technique known as *Last Resource Commit Optimization (LRCO)*. This is sometimes called the *Last Resource Gambit*. The one-phase-aware resource is processed last in the **prepare** phase of the transaction, at which time an attempt is made to commit it. If the attempt is successful, the transaction log is written and the remaining resources go through the phase-two commit. If the last resource fails to commit, the transaction is rolled back. Although this protocol allows most transactions to complete normally, some errors can cause an inconsistent transaction outcome. For this reason, use LRCO as a last resort. When a single `<local-tx-datasource>` is used in a transaction, the LRCO is automatically applied to it. In other situations, you can designate a last resource by using a special marker interface. Refer to the JBoss Transactions Programmer's Guide for more details.

Using more than a single one-phase resource in the same transaction is not transactionally safe, and is not recommended. JBoss Transaction Service sees an attempt to enlist a second such resource as an error and terminates the transaction. This type of error is most often found when migrating from a legacy version of JBoss Application Server. Whenever possible the `<local-tx-datasource>` should be converted to an `<xa-datasource>` to resolve the difficulty.

## 13.5. TRANSACTION TIMEOUT HANDLING

In order to prevent indefinite locking of resources, the transaction manager aborts in-flight transactions that have not completed after a specified interval, using a set of background processes coordinated by the `TransactionReaper`. The reaper rolls back transactions without interrupting any threads that may be operating within their scope. This prevents instability that results from interrupting threads executing arbitrary code. Furthermore, it allows for timely abort of transactions where the business logic thread may be executing non-interruptible operations such as network I/O operations. This approach may, cause unexpected behavior in code that is not designed to handle multithreaded transactions. Warning or error messages may be printed from transaction-aware components as a result of the unexpected change in transaction status. The transaction outcome should usually be unaffected. Any problems can be minimized by tuning the transaction timeout values. See [Chapter 17, Datasource Configuration](#) for more information.

## 13.6. RECOVERY CONFIGURATION

To ensure that your configuration is robust, it is important to configure JBoss Transaction Service properly for failure and recovery. This is covered in detail in the *JBoss Transactions Administration Guide*, in the "Resource Recovery in JBoss Transaction Service" chapter.

## 13.7. TRANSACTION SERVICE FAQ

This section presents some of the most common configuration issues with JBoss Transaction Service.

**Q:** I turned on debug logging, but nothing is logged.

**A:** JBossTS sends log statements though two levels of filters.

1. Logs go through JBoss Transaction Service's own logging abstraction layer.
2. Logs go through JBoss Enterprise Application Platform's `log4j` logging system.

A log statement must pass both filters to be printed. A typical mistake is enabling only one or the other of the logging systems. See [Table 13.2, “Additional Properties for JBoss Transaction Service”](#) for more information.

---

**Q: Why do server logs show WARN Adding multiple last resources is disallowed., and why are my transactions are aborted?**

**A:** You are probably using a `<local-xa-datasource>` and trying to use more than one one-phase aware participant. This is a configuration to be avoided. See [Section 13.4, “Last Resource Commit Optimization \(LRCO\)”](#) for more information. If you have further concerns, please contact Global Support Services.

---

**Q: My server terminated unexpectedly. It is running again, but my logs are filling with messages like WARN [com.arjuna.ats.jta.logging.loggerI18N] [com.arjuna.ats.internal.jta.resources.arjunacore.norecoveryxa] Could not find new XAResource to use for recovering non-serializable XAResource.**

**A:** You may not have configured all resource managers for recovery. Refer to the Recovery chapter of the JBoss Transactions Administration Guide for more information on configuring resource managers for recovery.

---

**Q: My transactions take a long time and sometimes strange things happen. The server log contains WARN [arjLoggerI18N] [BasicAction\_58] - Abort of action id ... invoked while multiple threads active within it.**

**A:** Transactions which exceed their timeout may be rolled back. This is done by a background thread, which can confuse some application code that may be expecting an interrupt. Refer to [Section 13.5, “Transaction Timeout Handling”](#) for more information.

---

---

---

If you have questions besides the ones addressed above, please consult the other JBoss Transactions guides, or contact Global Support Services.

## 13.8. USING THE JTS MODULE

If you need transaction propagation between business logic in different servers, you can use the JTS API. Although you can use it directly, it is typical to access it via the standard JTA classes. It is a drop-in replacement for the default local-only JTA implementation. The necessary classes are already in place, and you only need to modify the `jbossts-properties.xml` file to move between the JTA and JTS modules.

A sample `jbossts-properties.xml` file is located in the `<JBOSS_HOME>/docs/examples/transactions/` directory. Consult the `README.txt` file in the same directory for more information about changes that need to be made to other files, including the `transactions-jboss-beans.xml` file. An ANT script is provided to perform all of the steps automatically, but it is recommended to consult the `README.txt` carefully before running the script, as well as backing up your existing configuration.

The JTS requires the server configuration to also contain the CORBA ORB service. The "all" server profile referenced in the examples is a good starting point. The choice of JTS or JTA impacts the entire server, and JTS does require additional resources. Therefore, only use it when it is needed.

At application start-up, a server that is configured to use JTA outputs log files like this one:

```
INFO [TransactionManagerService] JBossTS Transaction Service (JTA
version - ...)
```

If JTS is enabled, the message looks like this one:

```
INFO [TransactionManagerService] JBossTS Transaction Service (JTS
version - ...)
```

## 13.9. USING THE XTS MODULE

XTS, which is the Web Services component of JBoss Transaction Service, can be installed to provide WS-AT and WS-BA support for web services hosted on the Enterprise Application Platform. The module is packaged as a *Service Archive (.sar)* located in `<JBOSS_HOME>/docs/examples/transactions/`.

### Procedure 13.1. Installing the XTS Module

1. Create a subdirectory in the `<JBOSS_HOME>/server/[name]/deploy/` directory, called `jbossxts.sar/`.
2. Unpack the `.sar`, which is a ZIP archive, into this new directory.
3. Restart JBoss Enterprise Application Platform for the module to be active.

The server must use either the JTA or JTS module, as well as JBossWS Native.



#### NOTE

XTS is not currently expected to work with other JBossWS backends such as CXF. The default XTS configuration is suitable for most deployments. It automatically detects information about the network interfaces and port bindings from the EAP configuration. manual configuration changes are only necessary for deployments whose applications need to use a transaction coordinator on a separate host. Consult the JBoss Web Service Transactions Programmer's Guide for more information.

Developers can link against the `jbossxts-api.jar` file included in the XTS Service Archive, but should avoid packaging it with their applications, to avoid classloading problems. All other JAR files contain internal implementation classes and should not be used directly.

Consult `<JBOSS_HOME>/docs/examples/transactions/README.txt` for more configuration information. The JBoss Web Services Transactions User Guide contains information about using XTS in your applications.

## 13.10. TRANSACTION MANAGEMENT CONSOLE

The Transaction Management Console is a simple GUI tool that is included in `<JBOSS_HOME>/docs/example/transactions/`. It is provided as an unsupported, experimental prototype. Consult the `README.txt` file for its capabilities and information about its use.

## 13.11. EXPERIMENTAL COMPONENTS

In addition to the supported components of JBoss Transaction Service which are included in JBoss Enterprise Application Platform, there is ongoing feature work that may eventually find its way into future releases of the product. In the meantime, these prototype components are available via from the <http://jboss.org> Community website.



### WARNING

There is no guarantee these components will work correctly and they are not covered under the Enterprise Application Platform support agreement. However, some of the advanced functionality available may useful for projects in the early stages of development. Users downloading these prototypes must be aware of the limitations concerning module compatibility, in accordance with the [Section 13.12, “Source Code and Upgrading”](#).

### txbridge

Sometimes you may need the ability to invoke traditional transaction components, such as EJBs, within the scope of a Web Services transaction. Conversely, some traditional transactional applications may need to invoke transactional web services. The Transaction Bridge (txbridge) provides mechanisms for linking these two types of transactional services together.

### BA Framework

The XTS API operates at a very low level, requiring the developer to undertake much of the transaction infrastructure work involved in WS-BA. The BA Framework provides high-level annotations that enable JBoss Transaction Service to handle this infrastructure. The developer can then focus more on business logic instead.

## 13.12. SOURCE CODE AND UPGRADING

Most problems relating to transactions can be diagnosed by Global Support Services, after you provide debug logging information from the server.

However, you can debug or review the source code yourself, using your own tools. You can download the source code using the Subversion repository at <http://anonsvn.jboss.org/repos/labs/labs/jbosstm/>. Enterprise Application Platform outputs the version of the Transaction Service at start up, using a string similar to this one:

```
INFO [TransactionManagerService] JBossTS Transaction Service (JTA
version - tag:JBOSSTS_4_6_1_GA_CP02) - JBoss Inc.
```

The `tag` element corresponds to a tree under `/tags/` in the Subversion repository. Note that the version refers to the version of the JBoss Transaction Service component used in the Enterprise Application Platform, not the version of EAP itself. If you build Enterprise Application Platform from source, you can also find the version by searching for the string `version.jboss.jbossts` in the `component-matrix/pom.xml` file.

**WARNING**

Installing any version of JBossTS other than those provided with the Enterprise Application Platform you are using is not supported. While some JBoss Transaction Service components are packaged separately, it is unsupported to use different versions than the ones supplied with Enterprise Application Platform.

## CHAPTER 14. REMOTING

The main objective of JBoss Remoting is to provide a single API for most network based invocations and related services that use pluggable transports and datamarshallers. The JBoss Remoting API provides the ability for making synchronous and asynchronous remote calls, push and pull callbacks, and automatic discovery of remoting servers. The intention is to allow for the addition of different transports to fit different needs, yet still maintain the same API for making the remote invocations and only requiring configuration changes, not code changes, to fit these different needs.

Out of the box, Remoting supplies multiple transports (bisocket, http, rmi, socket, servlet, and their ssl enabled counterparts), standard and compressing datamarshallers, and a configurable facility for switching between standard jdk serialization and JBoss Serialization. It is also capable of remote classloading, has extensive facilities for connection failure notification, performs call by reference optimization for client/server invocations collocated in a single JVM, and implements multihomed servers.

In the Enterprise Application Platform, Remoting supplies the transport layer for the EJB2, EJB3, and Messaging subsystems. In each case, the configuration of Remoting is largely predetermined and fixed, but there are times when it is useful to know how to alter a Remoting configuration.

### 14.1. BACKGROUND

A Remoting server consists of a Connector, which wraps and configures a transport specific server invoker. A connector is represented by an InvokerLocator string, such as

```
socket://bluemonkeydiamond.com:8888/?timeout=10000&serialization=jboss
```

which indicates that a server using the socket transport is accessible at port 8888 of host bluemonkeydiamond.com, and that the server is configured to use a socket timeout of 10000 and to use JBoss Serialization. A Remoting client can use an InvokerLocator to connect to a given server.

In the Enterprise Application Platform, Remoting servers and clients are created far below the surface and are accessible only through configuration files. Moreover, when a proxy for a SLSB, for example, is downloaded from the JNDI directory, it comes with a copy of the InvokerLocator, so that it knows how to contact the appropriate Remoting server. **The important fact to note is that, since the server and its clients share the InvokerLocator, the parameters in the InvokerLocator serve to configure both clients and servers.**

### 14.2. JOSS REMOTING CONFIGURATION

There are two kinds of XML files that can be used to create and configure a Remoting Connector. A file with a name of the form \*-service.xml can be used to define a Connector as an MBean, and a file of the form \*-jboss-beans.xml can be used to define a Connector as a POJO.

#### 14.2.1. MBeans

In the JBoss Messaging JMS subsystem, a Remoting server is configured in the file remoting-bisocket-service.xml, which, in abbreviated form, looks like

```
<mbean code="org.jboss.remoting.transport.Connector"
      name="jboss.messaging:service=Connector,transport=bisocket"
      display-name="Bisocket Transport Connector">
  <attribute name="Configuration">
    <config>
```

```

        <invoker transport="bisocket">
            <attribute name="marshaller"
isParam="true">org.jboss.jms.wireformat.JMSWireFormat</attribute>
            <attribute name="unmarshaller"
isParam="true">org.jboss.jms.wireformat.JMSWireFormat</attribute>
            <attribute
name="serverBindAddress">${jboss.bind.address}</attribute>
            <attribute name="serverBindPort">4457</attribute>
            <attribute name="callbackTimeout">10000</attribute>
            ...
        </invoker>
        ...
    </config>
</attribute>
</mbean>

```

This configuration file tells us several facts, including

- This server uses the bisocket transport;
- it runs on port 4457 of host `${jboss.bind.address}`; and
- JBoss Messaging uses its own marshaling algorithm.

The `InvokerLocator` is derived from this file. **The important fact to note is that the attribute "isParam" determines if a parameter is to be included in the `InvokerLocator`.** If "isParam" is omitted or set to false, the parameter will apply only to the server. In this case, the parameter will not be transmitted to the client. The `InvokerLocator` for a Remoting server with a `${jboss.bind.address}` of `bluemonkeydiamond.com` would be:

```

bisocket://bluemonkeydiamond.com:4457/?marshaller=
org.jboss.jms.wireformat.JMSWireFormat&
unmarshaller=org.jboss.jms.wireformat.JMSWireFormat

```

Note that the parameter "callbackTimeout" is not included in the `InvokerLocator`.

### 14.2.2. POJOs

The same Connector could be configured by way of the `org.jboss.remoting.ServerConfiguration` POJO:

```

    <bean name="JBMConnector"
class="org.jboss.remoting.transport.Connector">
        <annotation>@org.jboss.aop.microcontainer.aspects.jmx.JMX
            (name="jboss.messaging:service=Connector,transport=bisocket",
exposedInterface=org.jboss.remoting.transport.ConnectorMBean.class,
            registerDirectly=true)</annotation>
        <property name="serverConfiguration"><inject
bean="JBMConfiguration"/></property>
    </bean>

    <!-- Remoting server configuration -->
    <bean name="JBMConfiguration"
class="org.jboss.remoting.ServerConfiguration">

```

```

<constructor>
  <parameter>bisocket</parameter>
</constructor>

  <!-- Parameters visible to both client and server -->
<property name="invokerLocatorParameters">
  <map keyClass="java.lang.String" valueClass="java.lang.String">
    <entry>
      <key>serverBindAddress</key>
      <value>
        <value-factory bean="ServiceBindingManager"
method="getStringBinding">
          <parameter>JBMConnector</parameter>
          <parameter>${host}</parameter>
        </value-factory>
      </value>
    </entry>
    <entry>
      <key>serverBindPort</key>
      <value>
        <value-factory bean="ServiceBindingManager"
method="getStringBinding">
          <parameter>JBMConnector</parameter>
          <parameter>${port}</parameter>
        </value-factory>
      </value>
    </entry>
    ...
    <entry><key>marshaller</key>
<value>org.jboss.jms.wireformat.JMSWireFormat</value></entry>
    <entry><key>unmarshaller</key>
<value>org.jboss.jms.wireformat.JMSWireFormat</value></entry>
  </map>
</property>

  <!-- Parameters visible only to server -->
<property name="serverParameters">
  <map keyClass="java.lang.String" valueClass="java.lang.String">
    <entry><key>callbackTimeout</key> <value>10000</value></entry>
  </map>
</property>

  ...
</bean>

```

In this version, the configuration information is expressed in the `JBMConfiguration ServerConfiguration` POJO, which is then injected into the `JBMConnector org.jboss.remoting.transport.Connector` POJO. The syntax is that of the Microcontainer, which is beyond the scope of this chapter. See [Chapter 8, \*Microcontainer\*](#) for details. One variation from the MBean version is the use of the `ServiceBindingManager`, which is also beyond the scope of this chapter. Note that the `@org.jboss.aop.microcontainer.aspects.jmx.JMX` annotation causes the `JBMConnector` to be visible as an MBean named `"jboss.messaging:service=Connector,transport=bisocket"`.

## 14.3. MULTIHOMED SERVERS



Remoting can create servers bound to multiple interfaces. One application of this facility would be binding a server to one interface that faces the internet and another that faces a LAN. For example, the preceding POJO example can be modified by (1) adding POJOs

```

    <!-- Beans homes1 and homes2 are used to construct a multihome Remoting
server. -->
    <bean name="homes1" class="java.lang.StringBuffer">
        <constructor>
            <parameter class="java.lang.String">
                <value-factory bean="ServiceBindingManager"
method="getStringBinding">
                    <parameter>JBMConnector:bindingHome1</parameter>
                    <parameter>${host}:${port}</parameter>
                </value-factory>
            </parameter>
        </constructor>
    </bean>

    <bean name="homes2" class="java.lang.StringBuffer">
        <constructor factoryMethod="append">
            <factory bean="homes1"/>
            <parameter>
                <value-factory bean="ServiceBindingManager"
method="getStringBinding">
                    <parameter>JBMConnector:bindingHome2</parameter>
                    <parameter>!${host}:${port}</parameter>
                </value-factory>
            </parameter>
        </constructor>
    </bean>

```

which results in a StringBuffer with a value something like (according to the ServiceBindingManager configuration values for JBMConnector:bindingHome1 and JBMConnector:bindingHome2) "external.acme.com:5555!internal.acme.com:4444", and (2) replacing the "serverBindAddress" and "serverBindPort" parameters with

```

<entry>
    <key>homes</key>
    <value><value-factory bean="homes2" method="toString"/></value>
</entry>

```

which transforms the StringBuffer into the String "external.acme.com:5555!internal.acme.com:4444" and injects it into the JBMConnector. The resulting InvokerLocator will look like

```

bisocket://multihome/?homes=external.acme.com:5555!internal.acme.com:
4444&marshaller=org.jboss.jms.wireformat.JMSWireFormat&
unmarshaller=org.jboss.jms.wireformat.JMSWireFormat

```

## 14.4. ADDRESS TRANSLATION

Sometimes a server must be accessed through an address translating firewall, and a Remoting server can be configured with both a binding address/port and an address/port to be used by a client. Two more parameters are used: "clientConnectAddress" and "clientConnectPort". The "serverBindAddress" and "serverBindPort" values are used to create the server, and the values of

"clientConnectAddress" and "clientConnectPort" are used in the InvokerLocator, which tells the client where the server is. There is also an analogous "connecthomes" parameter for multihome servers. In this case, "homes" is used to configure the server, and "connecthomes" tells the client where the server is.

## 14.5. WHERE ARE THEY NOW?

The actual Remoting configuration files for the supported subsystems are as follows:

EJB2: `<JBASS_HOME>/server/<PROFILE>/deploy/remoting-jboss-beans.xml`

EJB3: `<JBASS_HOME>/server/<PROFILE>/deploy/ejb3-connectors-jboss-beans.xml`

JBM: `<JBASS_HOME>/server/<PROFILE>/deploy/messaging/remoting-bisocket-service.xml`

## 14.6. FURTHER INFORMATION.

Additional details may be found in the Remoting Guide at <http://www.jboss.org/jbossremoting/docs/guide/2.5/html/index.html>.

## CHAPTER 15. MESSAGING

### 15.1. DEFAULT JMS MESSAGING PROVIDERS

One of the following default JMS messaging providers can be used with JBoss Enterprise Application Platform:

- JBoss Messaging - detailed information can be found in *JBoss Messaging User Guide*.
- HornetQ - detailed information can be found in *HornetQ User Guide*.

Please refer to the dedicated guides mentioned with individual JMS providers for in-depth guidance on their configuration and use.

### 15.2. IBM WEBSPHERE MQ INTEGRATION

Apart from the default messaging options listed above, it is also possible to connect JBoss Enterprise Application Platform to a WebSphere MQ messaging system. WebSphere MQ is IBM's Messaging Oriented Middleware (MOM) software that allows applications on distributed systems to communicate with each other. This is accomplished through the use of messages and message queues. WebSphere MQ is responsible for delivering messages to the message queues and for transferring data to other queue managers using message channels. For more information about IBM WebSphere MQ, please refer to its documentation accessible at <http://www.ibm.com>.

Within the scope of the integration with JBoss Enterprise Application Platform, WebSphere MQ does not act as a default messaging provider equivalent to JBoss Messaging or Hornet Q. Instead, it runs as a standalone messaging system connected to JBoss Enterprise Application Platform through a resource adapter. While connected to WebSphere MQ, the platform still uses either JBoss Messaging or HornetQ as its default JMS messaging provider. This is typically useful when an application based on JBoss Enterprise Application Platform needs to be integrated with an existing infrastructure that uses WebSphere MQ.

#### 15.2.1. Configuring WebSphere MQ Integration

This section covers the general steps that need to be performed to deploy and configure the WebSphere MQ Resource Adapter in JBoss Enterprise Application Platform 5.

##### Prerequisites

The following is required before you get started configuring your instance of JBoss Enterprise Application Platform for integration with WebSphere MQ.

- A running instance of WebSphere MQ version 7.5.
- A WebSphere MQ JMS resource adapter. It is supplied with your distribution of WebSphere MQ as a Resource Archive (RAR) file called `wmq.jmsra.rar`. You can find it in the `MQ.HOME/java/lib/jca` directory.
- To configure the connection properly, you also need to know the values listed below. The names shown in capital letters are used in the code samples further in this chapter. When reusing the code, make sure that you replace these names with the actual values relevant for your WebSphere MQ instance.

**MQ.HOST.NAME**

The host name of the machine where the WebSphere MQ instance is running. It is also possible to specify the machine's IP address instead of the hostname.

**MQ.PORT**

The port used to connect to the WebSphere MQ queue manager. The default value is **1414**.

**MQ.CHANNEL.NAME**

The server channel used to connect to the WebSphere MQ queue manager. The default value is **SYSTEM.DEF.SVRCONN**.

**MQ.TRANSPORT.TYPE**

The transport type used for the connection to WebSphere MQ. The default value is **CLIENT**.

**MQ.HOME**

The path to the WebSphere MQ instance's base directory. The default is **/opt/mqm/** on Linux or Unix, **/usr/mqm/** on AIX and **C:\ProgramFiles\IBM\WebSphere MQ** on Windows.

**MQ.USER**

The user name of a user account with permissions to connect to the WebSphere MQ server by the broker.

**MQ.PASSWORD**

The password of the MQ.USER user account.

- Within the WebSphere MQ instance, you need to have objects like queue managers, queues, topics and channels defined according to the needs of your specific system. The list below contains WebSphere MQ objects that are used to demonstrate the configuration in the code samples further in this chapter. Similarly as above, when reusing the code samples, make sure that you replace the capitalized names with the names of the actual objects defined in your WebSphere MQ instance.

**MQ.QUEUE.MANAGER**

The name of the WebSphere MQ queue manager with which the connection will be established.

**MQ.QUEUE.REQUESTS**

The name of the destination message queue in WebSphere MQ to which request messages will be sent.

**MQ.QUEUE.RESPONSES**

The name of the source message queue in WebSphere MQ from which response messages will be received.

**MQ.TOPIC1**

The name of a topic defined in WebSphere MQ.

**MQ.TOPIC2**

The name of another topic defined in WebSphere MQ.

### Procedure 15.1. Deploying the WebSphere MQ Resource Adapter

1. Copy the `wmq.jmsra.rar` file to the `JBOSS_HOME/server/PROFILE/deploy/` directory.

```
cp MQ_HOME/java/lib/jca/wmq.jmsra.rar
   JBOSS_HOME/server/PROFILE/deploy/
```

2. Create a file named `jboss_jmsra_ds.xml` in the `JBOSS_HOME/server/PROFILE/deploy/` directory.

Below, you can find a code sample showing the expected content of the file. The first part of the XML file defines a connection factory used to establish the connection with the WebSphere MQ instance. The second part of the file defines JNDI bindings of objects defined in WebSphere MQ to JMS administered objects.

```
<?xml version="1.0" encoding="UTF-8"?>
<connection-factories>
  <!-- connection factory definition -->
  <tx-connection-factory>
    <jndi-name>jms/CF</jndi-name>
    <xa-transaction />
    <rar-name>wmq.jmsra.rar</rar-name>
    <connection-definition>javax.jms.ConnectionFactory</connection-
definition>
    <config-property name="channel"
type="java.lang.String">MQ.CHANNEL.NAME</config-property>
    <config-property name="hostName"
type="java.lang.String">MQ.HOST.NAME</config-property>
    <config-property name="port"
type="java.lang.String">MQ.PORT</config-property>
    <config-property name="username"
type="java.lang.String">MQ.USER</config-property>
    <config-property name="password"
type="java.lang.String">MQ.PASSWORD</config-property>
    <config-property name="queueManager"
type="java.lang.String">MQ.QUEUE.MANAGER</config-property>
    <config-property name="transportType"
type="java.lang.String">MQ.TRANSPORT.TYPE</config-property>
    <security-domain-and-application>JmsXARealm</security-domain-
and-application>
  </tx-connection-factory>

  <!-- admin object definitions -->
  <mbean code="org.jboss.resource.deployment.AdminObject"
name="jca.wmq:name=queue1">
    <attribute name="JNDIName">
      jms/queue/MQ.QUEUE.REQUESTS
    </attribute>
    <depends optional-attribute-name="RARName">
      jboss.jca:service=RARDeployment,name='wmq.jmsra.rar'
    </depends>
    <attribute name="Type">javax.jms.Queue</attribute>
```

```

    <attribute name="Properties">
      baseQueueManagerName=MQ.QUEUE.MANAGER
      baseQueueName=MQ.QUEUE.REQUESTS
    </attribute>
  </mbean>

  <mbean code="org.jboss.resource.deployment.AdminObject"
name="jca.wmq:name=topic1">
    <attribute name="JNDIName">
      jms/topic/MQ.TOPIC1
    </attribute>
    <depends optional-attribute-name="RARName">
      jboss.jca:service=RARDeployment,name='wmq.jmsra.rar'
    </depends>
    <attribute name="Type">javax.jms.Topic</attribute>
    <attribute name="Properties">
      brokerPubQueueManager=MQ.QUEUE.MANAGER
      baseTopicName=MQ.TOPIC1
    </attribute>
  </mbean>

  <mbean code="org.jboss.resource.deployment.AdminObject"
name="jca.wmq:name=queue2">
    <attribute name="JNDIName">
      jms/queue/MQ.QUEUE.RESPONSES
    </attribute>
    <depends optional-attribute-name="RARName">
      jboss.jca:service=RARDeployment,name='wmq.jmsra.rar'
    </depends>
    <attribute name="Type">javax.jms.Queue</attribute>
    <attribute name="Properties">
      baseQueueManagerName=MQ.QUEUE.MANAGER
      baseQueueName=MQ.QUEUE.RESPONSES
    </attribute>
  </mbean>

  <mbean code="org.jboss.resource.deployment.AdminObject"
name="jca.wmq:name=topic2">
    <attribute name="JNDIName">
      jms/topic/MQ.TOPIC2
    </attribute>
    <depends optional-attribute-name="RARName">
      jboss.jca:service=RARDeployment,name='wmq.jmsra.rar'
    </depends>
    <attribute name="Type">javax.jms.Topic</attribute>
    <attribute name="Properties">
      brokerPubQueueManager=MQ.QUEUE.MANAGER
      baseTopicName=MQ.TOPIC2
    </attribute>
  </mbean>
</connection-factories>

```

### 15.2.1.1. Using the WebSphere MQ resource adapter in an MDB

Once you have performed the configuration described above, you can access a message queue from the code of an MDB by specifying the `ActivationConfigProperty` and `ResourceAdapter` annotations as in the following code sample:

```
@MessageDriven(name="WebSphereMQMDB".
  activationConfig =
    {
      @ActivationConfigProperty(propertyName =
"destinationType",propertyValue = "javax.jms.Queue"),
      @ActivationConfigProperty(propertyName = "useJNDI", propertyValue =
"false"),
      @ActivationConfigProperty(propertyName = "hostName", propertyValue =
"MQ.HOST.NAME"),
      @ActivationConfigProperty(propertyName = "port", propertyValue =
"MQ.PORT"),
      @ActivationConfigProperty(propertyName = "channel", propertyValue =
"MQ.CHANNEL.NAME"),
      @ActivationConfigProperty(propertyName = "queueManager", propertyValue
= "MQ.QUEUE.MANAGER"),
      @ActivationConfigProperty(propertyName = "destination", propertyValue =
"MQ.QUEUE.REQUESTS"),
      @ActivationConfigProperty(propertyName = "transportType", propertyValue
= "MQ.TRANSPORT.TYPE"),
      @ActivationConfigProperty(propertyName = "username", propertyValue =
"MQ.USER"),
      @ActivationConfigProperty(propertyName = "password", propertyValue =
"MQ.PASSWORD")
    })
@ResourceAdapter(value = "wmq.jmsra.rar")
public class WebSphereMQMDB implements MessageListener {
}
```

### 15.2.1.2. Configuration for XA Transaction Recovery

If unfinished two-phase commit transactions are not recovered after a system crash, they can use storage space in the WebSphere MQ instance and cause performance problems. To prevent this, JBoss Enterprise Application Server's Transaction service can recover such transactions if a recovery module is configured for each resource. This section explains how to configure the XARecovery module for the sample WebSphere MQ instance configured previously in this chapter.

#### Prerequisites

Before you begin the configuration for XA transaction recovery, you need:

- JBoss Enterprise Application Platform and WebSphere MQ configured as described previously in this chapter.
- The `mqcontext.jar` library. It is available as part of IBM Support Pac: ME01, which can be downloaded from the IBM website. Installation of the pack adds the library to the `MQ.HOME/java/lib/` directory.
- An additional message queue created in WebSphere MQ for transaction recovery purposes. In the following code samples, it is referred to as `MQ.RECOVERY.QUEUE`.

#### Procedure 15.2. Configuring WebSphere MQ Integration for XA Transaction Recovery

1. In a directory of your choice on the WebSphere MQ server, create a `JMSAdmin.config` file with the following content:

```
INITIAL_CONTEXT_FACTORY=com.ibm.mq.jms.context.WMQInitialContextFactory
PROVIDER_URL=MQ.HOST.NAME:MQ.PORT/MQ.CHANNEL.NAME
```

2. In the same directory, create a file called `xaqcf_def.scp`. In the file, define an XA queue connection factory as follows:

```
def xaqcf(WNPMQMXACF) qmgr(MQ.QUEUE.MANAGER) tran(MQ.TRANSPORT.TYPE)
chan(MQ.CHANNEL.NAME) host(MQ.HOST.NAME) port(MQ.PORT)
```

3. Still in the same directory, create a `JMSAdmin.sh` script as follows:

```
CLASSPATH=$CLASSPATH:/opt/mqm/java/lib/jms.jar
CLASSPATH=$CLASSPATH:/opt/mqm/java/lib/com.ibm.mq.jar
CLASSPATH=$CLASSPATH:/opt/mqm/java/lib/com.ibm.mqjms.jar
CLASSPATH=$CLASSPATH:/opt/mqm/java/lib/jta.jar
CLASSPATH=$CLASSPATH:/opt/mqm/java/lib/connector.jar
CLASSPATH=$CLASSPATH:/opt/mqm/java/lib/jndi.jar
CLASSPATH=$CLASSPATH:/opt/mqm/java/lib/providerutil.jar
CLASSPATH=$CLASSPATH:/opt/mqm/java/lib/fscontext.jar
CLASSPATH=$CLASSPATH:/opt/mqm/java/lib/com.ibm.mqjms.jar
CLASSPATH=$CLASSPATH:/opt/mqm/java/lib/mqcontext.jar
export CLASSPATH
/opt/mqm/java/bin/JMSAdmin -v -cfg $PWD/JMSAdmin.config <
xaqcf_def.scp
```

All libraries necessary for JMSAdmin tools are linked from the default WebSphere MQ installation directory, which is `/opt/mqm`. Please modify the paths in the script accordingly if your WebSphere MQ installation is located elsewhere.

4. Launch the script created in the previous step. The script will append the required paths to the `CLASSPATH` variable and create the XA queue connection factory.
5. Copy the following libraries from `MQ.HOME/java/lib/` to the `JBOSS_HOME/server/PROFILE/lib/` directory:
  - o `dhbcore.jar`
  - o `mqcontext.jar`
  - o `com.ibm.mq.jar`
  - o `com.ibm.mqjms.jar`
  - o `com.ibm.mq.pcf.jar`
  - o `com.ibm.mq.jmqi.jar`
  - o `com.ibm.mq.headers.jar`
  - o `com.ibm.mq.commonservices.jar`



6. Create an external JNDI context by adding the following code to the **JBOSS\_HOME/server/PROFILE/conf/jboss-service.xml** file:

```
<mbean code="org.jboss.naming.ExternalContext"
name="jboss.jndi:service=ExternalContext,jndiName=IBMMQInitialContext"
  <attribute name="JndiName">IBMMQInitialContext</attribute>
  <attribute
name="InitialContext">javax.naming.InitialContext</attribute>
  <attribute name="Properties">

java.naming.factory.initial=com.ibm.mq.jms.context.WMQInitialContext
Factory
  java.naming.factory.url.pkgs=com.ibm.mq.jms.naming
  java.naming.provider.url=MQ.HOST.NAME:MQ.PORT/MQ.CHANNEL.NAME
  </attribute>
</mbean>
```

Alternatively, it is possible to define the external JNDI context as a remote one by adding the **RemoteAccess** attribute to the MBean definition. In this case, the **IBMMQInitialContext/WNPMQMXACF** JNDI name used in the following step points to a remote connection factory in the WebSphere MQ broker.

```
<mbean code="org.jboss.naming.ExternalContext"
name="jboss.jndi:service=ExternalContext,jndiName=IBMMQInitialContext"
  <attribute name="JndiName">IBMMQInitialContext</attribute>
  <attribute
name="InitialContext">javax.naming.InitialContext</attribute>
  <!-- Indicates that the external context is remote -->
  <attribute name="RemoteAccess">>true</attribute>
  <attribute name="Properties">

java.naming.factory.initial=com.ibm.mq.jms.context.WMQInitialContext
Factory
  java.naming.factory.url.pkgs=com.ibm.mq.jms.naming
  java.naming.provider.url=MQ.HOST.NAME:MQ.PORT/MQ.CHANNEL.NAME
  </attribute>
</mbean>
```

7. Create a file called **wsmq-jmsprovider-ds.xml** in the **JBOSS\_HOME/server/PROFILE/conf/** directory.

Below, you can find a code sample showing the expected content of the file. The first part of the XML file defines a connection factory that supports XA transactions. The second part of the file defines JNDI bindings of the recovery queue defined in WebSphere MQ and of the XA connection factory. See the comments inside the code sample for more information.

```
<?xml version="1.0" encoding="UTF-8"?>
<connection-factories>
  <!-- connection factory definition -->
  <tx-connection-factory>
    <!-- Bind this ConnectionFactory with the JNDI -->
    <jndi-name>IbmMQJMSXA</jndi-name>
```

```

    <!-- Indicate that the connection factory supports XA
    transactions -->
    <xa-transaction/>
    <!-- rar-name is the actual RAR file name, in this case
    wmq.jmsra.rar -->
    <rar-name>wmq.jmsra.rar</rar-name>
    <!-- Do not prefix the JNDI name of the connection factory with
    the java: context and thus allow it to be looked up externally -->
    <use-java-context>true</use-java-context>
    <!-- connection-definition is the ConnectionFactory interface
    defined in the jboss_jmsra_ds.xml file -->
    <connection-definition>
        javax.jms.ConnectionFactory
    </connection-definition>
    <config-property name="hostName"
    type="java.lang.String">MQ.HOST.NAME:</config-property>
    <config-property name="username"
    type="java.lang.String">MQ.USER</config-property>
    <config-property name="password"
    type="java.lang.String">MQ.PASSWORD</config-property>
    <config-property name="port"
    type="java.lang.String">MQ.PORT</config-property>
    <config-property name="queueManager"
    type="java.lang.String">MQ.QUEUE.MANAGER</config-property>
    <config-property name="channel"
    type="java.lang.String">MQ.CHANNEL.NAME</config-property>
    <config-property name="transportType"
    type="java.lang.String">MQ.TRANSPORT.TYPE</config-property>
    <!-- define the security domain -->
    <security-domain-and-application>JmsXARealm</security-domain-
    and-application>
    </tx-connection-factory>

    <!-- admin object definitions -->

    <!-- Binding of the crash recovery queue in WebSphere MQ -->
    <mbean code="org.jboss.resource.deployment.AdminObject"
    name="jca.wmq:name=crashRecovery">
        <attribute name="JNDIName">
            queue/crashRecoveryQueue
        </attribute>
        <depends optional-attribute-name="RARName">
            jboss.jca:service=RARDeployment,name='wmq.jmsra.rar'
        </depends>
        <attribute name="Type">javax.jms.Queue</attribute>
        <attribute name="Properties">
            baseQueueManagerName=MQ.QUEUE.MANAGER
            baseQueueName=MQ.RECOVERY.QUEUE
        </attribute>
    </mbean>

    <!-- Binding of the XA Connection factory to the JMSProvider that
    is used by the transaction module -->
    <!-- The properties must match the Websphere MQ JNDI entry and the
    FactoryRef must match the xaqcf name -->
    <mbean code="org.jboss.jms.jndi.JMSProviderLoader"

```

```

name="jboss.jms:service=JMSProviderLoader,name=WSMQJmsWNPMQMProvider
">
  <!-- this will be bound to java:/... and you will need to use it
in conf/jbossts-properties.xml -->
  <attribute name="ProviderName">WSMQJmsWNPMQMProvider</attribute>
  <attribute
name="ProviderAdapterClass">org.jboss.jms.jndi.JNDIProviderAdapter</
attribute>
  <attribute
name="FactoryRef">IBMMQInitialContext/WNPMQMXACF</attribute>
  <attribute
name="QueueFactoryRef">IBMMQInitialContext/WNPMQMXACF</attribute>
  <attribute
name="TopicFactoryRef">IBMMQInitialContext/WNPMQMXACF</attribute>
  <!-- external context defined in conf/jboss-service.xml -->

<depends>jboss.jndi:service=ExternalContext,jndiName=IBMMQInitialCon
text</depends>
</mbean>
</connection-factories>

```

8. Add the the **JMSProviderLoader** reference to the **<properties depends="arjuna" name="jta">** section of the **JBASS\_HOME/server/PROFILE/conf/jbossts-properties.xml** file. The **WSMQJmsWNPMQMProvider** value must match the name in the **JMSProviderLoader** definition in the **wsmq-jmsprovider-ds.xml** file.

```

<!-- the value has to correspond with property
com.arjuna.ats.arjuna.xa.nodeIdentifier -->
<property name="com.arjuna.ats.jta.xaRecoveryNode" value="1" />
<!-- IBM MQ settings -->
<!-- the WSMQJmsWNPMQMProvider must match the name in the
JMSProviderLoader definition in the *-ds.xml file. -->
<property
name="com.arjuna.ats.jta.recovery.XAResourceRecovery.WSMQWNPMQM"
value="org.jboss.jms.server.recovery.MessagingXAResourceRecovery;jav
a:/WSMQJmsWNPMQMProvider"/>

```

9. Restart the JBoss Enterprise Application Server instance. After the restart, the connection will be established. The connection factory will be available under the **IbmMQJMSXA** JNDI name (bound by JCA). The XA connection factory will be available under the **IBMMQInitialContext/WNPMQMXACF** JNDI name (bound as external context).

If the connection is not established successfully, the following WARN message will be periodically logged:

```

2011-06-10 10:44:08,707 WARN [loggerI18N]
[com.arjuna.ats.internal.jta.recovery.xarecovery1]
Local XARecoveryModule.xaRecovery got XA exception
javax.transaction.xa.XAException:
Error trying to connect to provider java:/WSMQJmsWNPMQMProvider,
XAException.XAER_RMERR

```

# CHAPTER 16. USING PRODUCTION DATABASES WITH JBOSS ENTERPRISE APPLICATION PLATFORM

## 16.1. HOW TO USE PRODUCTION DATABASES

JBoss utilizes the Hypersonic database as its default database. While this is good for development and prototyping, you or your company will probably require another database to be used for production. This chapter covers configuring JBoss Enterprise Application Platform to use production databases. We cover the procedures for all officially supported databases on the JBoss Enterprise Application Platform. For a complete list of certified databases, refer to <http://www.jboss.com/products/platforms/application/supportedconfigurations/>.

Please note that in this chapter, we explain how to use production databases to support all services in JBoss Enterprise Application Platform. This includes all the system level services such as EJB and JMS. For individual applications (e.g., WAR or EAR) deployed in JBoss Enterprise Application Platform, you can still use any backend database by setting up the appropriate data source connection.

Installing the external database is out of the scope of this document. Use the tools provided by your database vendor to set up an empty database. You will need the database name, connection URL, username, and password, in order to create the datasources the Platform will use to connect to the database.

## 16.2. INSTALLING JDBC DRIVERS

To use the selected external database, you must also install the JDBC driver for your database. The JDBC driver is a JAR file, which must be placed into the `<JBOSS_HOME>/server/<PROFILE>/lib` directory. Replace `<PROFILE>` with the server profile you are using.

This file is loaded when JBoss Enterprise Application Platform starts up, so if you have the JBoss Enterprise Application Platform running, you will need to shut down and restart. Review the list below for a suitable JDBC driver. For a full list of certified JBoss Enterprise Application Platform database drivers, refer to <http://www.jboss.com/products/platforms/application/supportedconfigurations/#JEAP5-0>. If the links fail to work, please file a JIRA against this documentation, but be aware that Red Hat does not control these external links. Contact your database vendor for the most current version of the driver for your database.

### JBDC Driver Download Locations

#### MySQL

Download from <http://www.mysql.com/products/connector/>.

#### PostgreSQL

Download from <http://jdbc.postgresql.org/>.

#### Oracle

Download from [http://www.oracle.com/technology/software/tech/java/sqlj\\_jdbc/index.html](http://www.oracle.com/technology/software/tech/java/sqlj_jdbc/index.html).

#### IBM

Download from <http://www-306.ibm.com/software/data/db2/java/>.

## Sybase

Download from the Sybase jConnect product page <http://www.sybase.com/products/allproductsa-z/softwaredeveloperkit/jconnect>.



### NOTE

When using Sybase database with this driver, the `MaxParams` attribute cannot be set higher than 481 due to a limitation in the driver's `PreparedStatement` class.

## Microsoft

Download from the MSDN web site <http://msdn.microsoft.com/data/jdbc/>.

## 16.2.1. Special Notes on Sybase

Some of the services in JBoss uses null values for the default tables that are created. Sybase Adaptive Server should be configured to allow nulls by default.

```
sp_dboption db_name, "allow nulls by default", true
```

Refer to the Sybase manuals for more options.

Additionally, text and image values stored in the database can be very large. When a select list includes both text and image values, the length limit of the data returned is determined by the `@@textsize` global variable. The default setting for this variable depends on the software used to access Adaptive Server. For the JDBC driver, the default value is 32 kilobytes.

### 16.2.1.1. Enable JAVA services

To use any Java service (for example; JMS, CMP, timers) configured with Sybase, Java must be enabled on Sybase Adaptive Server. To do this use:

```
sp_configure "enable java",1
```

Refer to the sybase manuals for more information.

If Java is not enabled for Sybase Adaptive Server, the following error message may be echoed in the console.

```
com.sybase.jdbc2.jdbc.SybSQLException: Cannot run this command because
Java services are not
    enabled. A user with System Administrator (SA) role must
reconfigure the system to enable Java
```

### 16.2.1.2. CMP Configuration

To use Container Managed Persistence for user defined Java objects with Sybase Adaptive Server Enterprise, the Java classes should be installed in the database. The system table `sysxtypes` contains one row for each extended Java-SQL datatype. This table is only used for Adaptive Servers enabled for Java. Install Java classes using the `installjava` program.

```
installjava -f <jar-file-name> -S<sybase-server> -U<super-user> -P<super-pass> -D<db-name>
```

Refer to the `installjava` manual in Sybase for more options.

### 16.2.1.3. Installing Java Classes

1. You have to be a super-user with required privileges to install Java classes.
2. The JAR file you are trying to install should be created without compression.
3. Java classes that you install and use in the server must be compiled with JDK 1.2.2. If you compile a class with a later JDK, you will be able to install it in the server using the `installjava` utility, but you will get a `java.lang.ClassFormatError` exception when you attempt to use the class. This is because Sybase Adaptive Server uses an older JVM internally, and requires the Java classes to be compiled with the same.

### 16.2.1.4. Increase @@textsize Default for Sybase v15.0.3

A problem with the default maximum text size value returned from the database may cause some tests to fail on JBoss Messaging. To correct the issue, change the default `@@textsize` value from 32768 (bytes) to 2147483647 (bytes).

Make the change in the `sybase-ds.xml` file inside a `<connection-url>` directive. An example `sybase-ds.xml` file is located in `<JBOSS_HOME>/jboss-as/docs/examples/jca/`

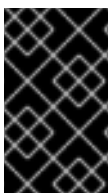

#### IMPORTANT

Specify the entire URL to the database as the directive value. Replace `[domain]` with the domain name or IP address hosting the Sybase Database, and `[port]` with the port configured to accept requests.

```
<connection-url>jdbc:sybase:[domain]:[port]/db_name?SQLINITSTRING=set
  TextSize 2147483647</connection-url>
```

### 16.2.2. Configuring JDBC DataSources

Datasources correspond to the simplified JCA Datasource configuration specifications.

Datasources need to reside in the `<JBOSS_HOME>/server/<PROFILE>/deploy` directory, alongside other deployable applications and resources. The files use a standard naming scheme of `DBNAME-ds.xml`.

Example datasources for all certified databases are located in the `<JBOSS_HOME>/docs/examples/jca` directory. Edit the datasource that corresponds to your database, and copy it to the `deploy/` directory before restarting the application server.

See [Chapter 17, Datasource Configuration](#) for information on configuring datasources. As a minimum, you will need to change the `connection-url`, `user-name`, and `password` to correspond to your database of choice.

## 16.3. SWITCHING TO A PRODUCTION DATABASE

You can use the Database Configuration Tool to switch to a production database. The Database Configuration Tool is an Apache Ant script that sets the database to be used by JBoss Enterprise Application Platform. The script can be found in the `JBOSS_HOME/jboss-as/tools/schema/` directory.

### Prerequisites

- Apache Ant must be installed.
- The database that you wish to use must already exist.
- A user with permission to make changes to that database must already exist.
- The JDBC driver JAR file for the database must be in the server configuration's `lib/` directory.



### WARNING

You can only use the Database Configuration Tool to change the database configuration once. Also, it must be run before any other changes are made. If you try to run the script on an installation that has already been configured, it may not work as intended.

#### 1. Back Up Your Server Profile

Make a copy of the server profile for which you plan to configure your database as the Database Configuration Tool modifies the configuration settings. `cp -R JBOSS_HOME/jboss-as/server/Profile /path/to/backup/folder.`

#### 2. Run the Database Configuration Tool

Change to the directory containing the Database Configuration Tool script: `cd JBOSS_HOME/jboss-as/tools/schema`

#### 3. Run Apache Ant

Run the `ant` command to launch the script.

#### 4. Enter Data

Following the prompts, enter the following information as it is requested:

- the type of database being used,
- the name of the database,
- the host name or IP Address of the database,
- the TCP port being used for the database,
- the user name needed to access the database, and
- the password for the user account.

**NOTE**

You could also add these values directly to the `build.properties` file (found in the same directory) before running the script. The Database Configuration Tool will not prompt you for these properties if it finds you have already added them to the file.

**Result**

The Database Configuration Tool updates the relevant configuration files and exits. JBoss Enterprise Application Platform is then reconfigured for use with the production database.

## 16.4. COMMON DATABASE-RELATED TASKS

### 16.4.1. Security and Pooling

Unless the `ResourceAdapter` has `<reauthentication-support>`, using multiple security identities will create subpools for each identity.

**NOTE**

The min and max pool size are per subpool, so be careful with these parameters if you have lots of identities.

### 16.4.2. Change Database for the JMS Services

The JMS service in the JBoss Enterprise Application Platform uses relational databases to persist its messages. For improved performance, we should change the JMS service to take advantage of the external database. To do that, we need to replace the file `<JBOSS_HOME>/server/<PROFILE>/deploy/messaging/$DATABASE-persistence-service.xml` with the `$DATABASE-persistence-service.xml` filename depending on your external database.

- MySQL: `mysql-persistence-service.xml`
- PostgreSQL: `postgresql-persistence-service.xml`
- Oracle: `oracle-persistence-service.xml`
- DB2: `db2-persistence-service.xml`
- Sybase: `sybase-persistence-service.xml`
- MS SQL Server: `mssql-persistence-service.xml`

### 16.4.3. Support Foreign Keys in CMP Services

Next, we need to go change the `<JBOSS_HOME>/server/<PROFILE>/conf/standardjbosscmp-jdbc.xml` file so that the `fk-constraint` property is `true`. That is needed for all external databases we support on the JBoss Enterprise Application Platform. This file configures the database connection settings for the EJB2 CMP beans deployed in the JBoss Enterprise Application Platform.

```
<fk-constraint>true</fk-constraint>
```



### 16.4.4. Specify Database Dialect for Java Persistence API

The Java Persistence API (JPA) entity manager can save EJB3 entity beans to any backend database. Hibernate provides the JPA implementation in JBoss Enterprise Application Platform. Hibernate has a dialect auto-detection mechanism that works for most databases including the dialects for databases referenced in this appendix which are listed below. If a specific dialect is needed for production databases, you can configure the database dialect in the `<JBOSS_HOME>/server/<PROFILE>/deployers/ejb3.deployer/META-INF/jpa-deployers-jboss-beans.xml` file. To configure this file you need to uncomment the set of tags related to the map entry `hibernate.dialect` and change the values to the following based on the database you setup.

- Oracle 10g: `org.hibernate.dialect.Oracle10gDialect`
- Oracle 11g: `org.hibernate.dialect.Oracle10gDialect`
- Microsoft SQL Server 2008: `org.hibernate.dialect.SQLServerDialect`
- PostgreSQL 8.2.3: `org.hibernate.dialect.PostgreSQLDialect`
- PostgreSQL 8.3.7: `org.hibernate.dialect.PostgreSQLDialect`
- MySQL 5.0: `org.hibernate.dialect.MySQL5InnoDBDialect`
- MySQL 5.1: `org.hibernate.dialect.MySQL5InnoDBDialect`
- DB2 9.1: `org.hibernate.dialect.DB2Dialect`
- Sybase ASE 15: `org.hibernate.dialect.SybaseASE15Dialect`

### 16.4.5. Change Other JBoss Enterprise Application Platform Services to use the External Database

Besides JMS, CMP, and JPA, we still need to hook up the rest of JBoss services with the external database. There are two ways to do it. One is easy but inflexible. The other is flexible but requires more steps. Now, let us discuss those two approaches respectively.

#### 16.4.5.1. The Easy Way

The easy way is just to change the JNDI name for the external database to `DefaultDS`. Most JBoss services are hard-wired to use the `DefaultDS` by default. So, by changing the `DataSource` name, we do not need to change the configuration for each service individually.

To change the JNDI name, just open the `*-ds.xml` file for your external database, and change the value of the `jndi-name` property to `DefaultDS`. For instance, in `mysql-ds.xml`, you would change `MySqlDS` to `DefaultDS` and so on. You will need to remove the `<JBOSS_HOME>/server/<PROFILE>/deploy/hsqldb-ds.xml` file after you are done to avoid duplicated `DefaultDS` definition.

In the `messaging/$DATABASE-persistence-service.xml` file, you should also change the `datasource` name in the `depends` tag for the `PersistenceManagers` MBean to `DefaultDS`. For instance, for `mysql-persistence-service.xml` file, we change the `MySqlDS` to `DefaultDS`.

`<mbean`

```
code="org.jboss.messaging.core.jmx.JDBCPersistenceManagerService"
    name="jboss.messaging:service=PersistenceManager"
    xmbean-dd="xmdesc/JDBCPersistenceManager-xmbean.xml">

<depends>jboss.jca:service=DataSourceBinding,name=DefaultDS</depends>
```

### 16.4.5.2. The More Flexible Way

Changing the external datasource to `DefaultDS` is convenient. But if you have applications that assume the `DefaultDS` always points to the factory-default HSQL DB, that approach could break your application. Also, changing `DefaultDS` destination forces all JBoss services to use the external database. What if you want to use the external database only on some services?

A safer and more flexible way to hook up JBoss Enterprise Application Platform services with the external `DataSource` is to manually change the `DefaultDS` in all standard JBoss services to the `DataSource` JNDI name defined in your `*-ds.xml` file (for example, the `MySQLDS` in `mysql-ds.xml`, etc.). Below is a complete list of files that contain `DefaultDS`. You can update them all to use the external database on all JBoss services or update some of them to use different combination of `DataSources` for different services.

- `<JBOSS_HOME>/server/<PROFILE>/conf/login-config.xml`: This file is used in Java EE container managed security services.
- `JBOSS_HOME/server/<PROFILE>/conf/standardjbosscomp-jdbc.xml`: This file configures the CMP beans in the EJB container.
- `<JBOSS_HOME>/server/<PROFILE>/deploy/ejb2-timer-service.xml`: This file configures the EJB timer services.
- `<JBOSS_HOME>/server/<PROFILE>/deploy/juddi-service.sar/META-INF/jboss-service.xml`: This file configures the UUDI service.
- `<JBOSS_HOME>/server/<PROFILE>/deploy/juddi-service.sar/juddi.war/WEB-INF/jboss-web.xml`: This file configures the UUDI service.
- `<JBOSS_HOME>/server/<PROFILE>/deploy/juddi-service.sar/juddi.war/WEB-INF/juddi.properties`: This file configures the UUDI service.
- `<JBOSS_HOME>/server/<PROFILE>/deploy/uuid-key-generator.sar/META-INF/jboss-service.xml`: This file configures the UUDI service.
- `<JBOSS_HOME>/server/<PROFILE>/deploy/messaging/messaging-jboss-beans.xml` and `<JBOSS_HOME>/server/<PROFILE>/deploy/messaging/persistence-service.xml`: Those files configure the JMS persistence service as we discussed earlier.

### 16.4.6. A Special Note About Oracle Databases

In our setup discussed in this chapter, we rely on the JBoss Enterprise Application Platform to automatically create needed tables in the external database upon server start up. That works most of the time. But for databases like Oracle, there might be some minor issues if you try to use the same database server to back more than one JBoss Enterprise Application Platform instance.

The Oracle database creates tables of the form `schemaname.tablename`. The **TIMERS** and **HILOSEQUENCES** tables needed by JBoss Enterprise Application Platform would not be created on a schema if the table already existed on a different schema. To work around this issue, you need to edit the `<JBOSS_HOME>/server/<PROFILE>/deploy/ejb2-timer-service.xml` file to change the table name from **TIMERS** to something like `schemaname2.tablename`.

```
<mbean code="org.jboss.ejb.txtimer.DatabasePersistencePolicy"
name="jboss.ejb:service=EJBTimerService,persistencePolicy=database">
  <!-- DataSourceBinding ObjectName -->
  <depends optional-attribute-name="DataSource">
    jboss.jca:service=DataSourceBinding,name=DefaultDS
  </depends>
  <!-- The plugin that handles database persistence -->
  <attribute name="DatabasePersistencePlugin">
    org.jboss.ejb.txtimer.GeneralPurposeDatabasePersistencePlugin
  </attribute>
  <!-- The timers table name -->
  <attribute name="TimersTable">TIMERS</attribute>
</mbean>
```

Similarly, you need to change the `<JBOSS_HOME>/server/<PROFILE>/deploy/uuid-key-generator.sar/META-INF/jboss-service.xml` file to change the table name from **HILOSEQUENCES** to something like `schemaname2.tablename` as well.

```
<!-- HiLoKeyGeneratorFactory --> <mbean
code="org.jboss.ejb.plugins.keygenerator.hilo.HiLoKeyGeneratorFactory"
  name="jboss:service=KeyGeneratorFactory,type=HiLo">

  <depends>jboss:service=TransactionManager</depends>

  <!-- Attributes common to HiLo factory instances -->

  <!-- DataSource JNDI name -->
  <depends optional-attribute-
name="DataSource">jboss.jca:service=DataSourceBinding,name=DefaultDS</depe
nds>

  <!-- table name -->
  <attribute name="TableName">HILOSEQUENCES</attribute>
```

## IMPORTANT

Oracle JDBC driver version 11.1.0.7.0 causes the JBoss Messaging Test Suite to fail with a `SQLException` ("Bigger type length than Maximum") on Oracle 11g R1.

This is caused by a regression in Oracle JDBC driver 11.1.0.7.0.

We recommend Oracle JDBC driver version 11.2.0.1.0 for use with Oracle 11g R1, Oracle 11g R2, Oracle RAC 11g R1 and Oracle RAC 11g R2.

## CHAPTER 17. DATASOURCE CONFIGURATION



### WARNING

The default persistence configuration works out of the box with Hypersonic (HSQLDB) so that the JBoss Enterprise Platforms are able to run "out of the box". However, *Hypersonic is not supported in production and should not be used in a production environment.*

Known issues with the Hypersonic Database include:

- no transaction isolation;
- thread and socket leaks (`connection.close()` does not tidy up resources);
- persistence quality (logs commonly become corrupted after a failure, preventing automatic recovery);
- database corruption;
- stability under load (database processes cease when dealing with too much data);
- and not viable in clustered environments.

Check the "Using Other Databases" chapter of the *Getting Started Guide* for assistance.

Datasources are defined inside a `<datasources>` element. The exact element depends on the type of datasource required.

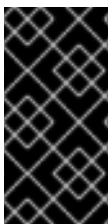

### IMPORTANT

Attempting to deploy more than one datasource file in an application's archive file (esb, war, ear), will lead to an exception being thrown.

Deploying multiple datasource files is not supported in EAP5.2.0

## 17.1. TYPES OF DATASOURCES

### Datasource Definitions

#### `<no-tx-datasource>`

Does not take part in JTA transactions. The `java.sql.Driver` is used.

#### `<local-tx-datasource>`

Does not support two phase commit. The `java.sql.Driver` is used. Suitable for a single database or a non-XA-aware resource.

#### **<xa-datasource>**

Supports two phase commit. The `javax.sql.XADataSource` driver is used.

## 17.2. DATASOURCE PARAMETERS

### Common Datasource Parameters

#### **<mbean>**

A standard JBoss MBean deployment.

#### **<depends>**

The `ObjectName` of an MBean service this `ConnectionFactory` or `DataSource` deployment depends upon. The connection manager service will not be started until the dependent services have been started.

#### **<jndi-name>**

The JNDI name under which the Datasource should be bound.

#### **<use-java-context>**

Boolean value indicating whether the `jndi-name` should be prefixed with `java:`. This prefix causes the Datasource to only be accessible from within the JBoss Enterprise Application Platform virtual machine. Defaults to `TRUE`.

#### **<user-name>**

The user name used to create the connection to the datasource.

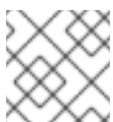

#### **NOTE**

Not used when security is configured.

#### **<password>**

The password used to create the connection to the datasource.

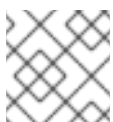

#### **NOTE**

Not used when security is configured.

#### **<transaction-isolation>**

The default transaction isolation of the connection. If not specified, the database-provided default is used.

**Possible values for <transaction-isolation>**

- *TRANSACTION\_READ\_UNCOMMITTED*
- *TRANSACTION\_READ\_COMMITTED*
- *TRANSACTION\_REPEATABLE\_READ*
- *TRANSACTION\_SERIALIZABLE*
- *TRANSACTION\_NONE*

#### <new-connection-sql>

An SQL statement that is executed against each new connection. This can be used to set up the connection schema, for instance.

#### <check-valid-connection-sql>

An SQL statement that is executed before the connection is checked out from the pool to make sure it is still valid. If the SQL statement fails, the connection is closed and a new one is created.

#### <valid-connection-checker-class-name>

A class that checks whether a connection is valid using a vendor-specific mechanism.

#### <exception-sorter-class-name>

A class that parses vendor-specific messages to determine whether SQL errors are fatal, and destroys the connection if so. If empty, no errors are treated as fatal.

#### <track-statements>

Whether to monitor for un-closed Statements and ResultSets and issue warnings when they have not been closed. The default value is **NOWARN**.

#### <prepared-statement-cache-size>

The number of prepared statements per connection to be kept open and reused in subsequent requests. They are stored in a *Least Recently Used (LRU)* cache. The default value is **0**, meaning that no cache is kept.

#### <share-prepared-statements>

When the <prepared-statement-cache-size> is non-zero, determines whether two requests in the same transaction should return the same statement. Defaults to **FALSE**.

#### Example 17.1. Using <share-prepared-statements>

The goal is to work around questionable driver behavior, where the driver applies auto-commit semantics to local transactions.

```

false    Connection c = dataSource.getConnection(); // auto-commit ==
        PreparedStatement ps1 = c.prepareStatement(...);
        ResultSet rs1 = ps1.executeQuery();
        PreparedStatement ps2 = c.prepareStatement(...);
        ResultSet rs2 = ps2.executeQuery();

```

This assumes that the prepared statements are the same. For some drivers, `ps2.executeQuery()` automatically closes `rs1`, so you actually need two real prepared statements behind the scenes. This only applies to the auto-commit semantic, where re-running the query starts a new transaction automatically. For drivers that follow the specification, you can set it to `TRUE` to share the same real prepared statement.

### `<set-tx-query-timeout>`

Whether to enable query timeout based on the length of time remaining until the transaction times out. Defaults to `FALSE`.

### `<query-timeout>`

The maximum time, in seconds, before a query times out. You can override this value by setting `<set-tx-query-timeout>` to `TRUE`.

### `<type-mapping>`

A pointer to the type mapping in `conf/standardjbosscmp.xml`. This element is a child element of `<metadata>`. A legacy from JBoss4.

### `<validate-on-match>`

Whether to validate the connection when the JCA layer matches a managed connection, such as when the connection is checked out of the pool. With the addition of `<background-validation>` this is not required. It is usually not necessary to specify `TRUE` for `<validate-on-match>` in conjunction with specifying `TRUE` for `<background-validation>`. Defaults to `TRUE`.

### `<prefill>`

Whether to attempt to prefill the connection pool to the minimum number of connections. Only *supporting pools* (OnePool) support this feature. A warning is logged if the pool does not support prefilling. Defaults to `TRUE`.

### `<background-validation>`

Background connection validation reduces the overall load on the RDBMS system when validating a connection. When using this feature, EAP checks whether the current connection in the pool a separate thread (ConnectionValidator). `<background-validation-minutes>` depends on this value also being set to `TRUE`. Defaults to `FALSE`.



#### WARNING

The `<background-validation>` parameter has been deprecated and is no longer supported: set the `<background-validation-millis>` parameter to a value greater than 0 and background validation will be enabled automatically.

### `<background-validation-millis>`

Background connection validation reduces the overall load on the RDBMS system when validating a connection. Setting this parameter means that JBoss will attempt to validate the current

connections in the pool as a separate thread (**ConnectionValidator**). This parameter's value defines the interval for which the **ConnectionValidator** runs. The value should differ from the `<idle-timeout-minutes>` value). The default value of the property is `0`. If `<background-validation-millis>` is set to a value greater than `0`, the background validation is enabled.

This value should not be the same as your `<idle-timeout-minutes>` value.

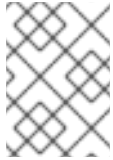

#### NOTE

You should set this to a smaller value than `<idle-timeout-minutes>`, unless you have specified `<min-pool-size>` a minimum pool size set.

#### `<idle-timeout-minutes>`

The maximum time, in minutes, before an idle connection is closed. A value of `0` disables timeout. Defaults to `15` minutes.

#### `<track-connection-by-tx>`

Whether the connection should be locked to the transaction, instead of returning it to the pool at the end of the transaction. In previous releases, this was `true` for local connection factories and `false` for XA connection factories. The default is now `true` for both local and XA connection factories, and the element has been deprecated.

#### `<interleaving>`

Enables interleaving for XA connection factories.

#### `<background-validation-minutes>`

How often, in minutes, the **ConnectionValidator** runs. Default to `0` mills.



#### WARNING

The `<background-validation-minutes>` parameter has been deprecated and is no longer supported: use the `<background-validation-millis>` parameter instead.



#### NOTE

You should set this to a smaller value than `<idle-timeout-minutes>`, unless you have specified `<min-pool-size>` a minimum pool size set.

#### `<url-delimiter>`, `<url-property>`, `<url-selector-strategy-class-name>`

Parameters dealing with database failover. As of JBoss Enterprise Application Platform 5.1, these are configured as part of the main datasource configuration. In previous versions, `<url-delimiter>` appeared as `<url-delimiter>`.



**<stale-connection-checker-class-name>**

An implementation of `org.jboss.resource.adapter.jdbc.StateConnectionChecker` that decides whether `SQLExceptions` that notify of bad connections throw the `org.jboss.resource.adapter.jdbc.StateConnectionException` exception.

**<max-pool-size>**

The maximum number of connections allowed in the pool. If undefined, the size defaults to **10**. The value in the example datasource definition (`<JBOSS_HOME>/server/<PROFILE>/deploy/hsqldb-ds.xml`) is set to 20.

**<min-pool-size>**

The minimum number of connections maintained in the pool. Unless `<prefill>` is **TRUE**, the pool remains empty until the first use, at which point the pool is filled to the `<min-pool-size>`. When the pool size drops below the `<min-pool-size>` due to idle timeouts, the pool is refilled to the `<min-pool-size>`. Defaults to **0**.

**<blocking-timeout-millis>**

The length of time, in milliseconds, to wait for a connection to become available when all the connections are checked out. Defaults to **30000**, which is 30 seconds.

**<use-fast-fail>**

Whether to continue trying to acquire a connection from the pool even if the previous attempt has failed, or begin failover. This is to address performance issues where validation SQL takes significant time and resources to execute. Defaults to **FALSE**.

**Parameters for `javax.sql.XDataSource` Usage****<connection-url>**

The JDBC driver connection URL string

**<driver-class>**

The JDBC driver class implementing the `java.sql.Driver`

**<connection-property>**

Used to configure the connections retrieved from the `java.sql.Driver`.

**Example 17.2. Example `<connection-property>`**

```
<connection-property name="char.encoding">UTF-8</connection-property>
```

**Parameters for `javax.sql.XDataSource` Usage****<xa-datasource-class>**

The class implementing the `XDataSource`

**<xa-datasource-property>**

Properties used to configure the `XADatasource`.

**Example 17.3. Example <xa-datasource-property> Declarations**

```
<xa-datasource-property name="IfxWAITTIME">10</xa-datasource-
property>
<xa-datasource-property name="IfxIFXHOST">myhost.mydomain.com</xa-
datasource-property>
<xa-datasource-property name="PortNumber">1557</xa-datasource-
property>
<xa-datasource-property name="DatabaseName">mydb</xa-datasource-
property>
<xa-datasource-property name="ServerName">myserver</xa-datasource-
property>
```

**<xa-resource-timeout>**

The number of seconds passed to `XAResource.setTimeout()` when not zero.

**<isSameRM-override-value>**

When set to `FALSE`, fixes some problems with Oracle databases.

**<no-tx-separate-pools>**

Pool transactional and non-transactional connections separately

**WARNING**

Using this option will cause your total pool size to be twice `max-pool-size`, because two actual pools will be created.

Used to fix problems with Oracle.

**Security Parameters****<application-managed-security>**

Uses the username and password passed on the `getConnection` or `createConnection` request by the application.

**<security-domain>**

Uses the identified login module configured in `conf/login-module.xml`.

**<security-domain-and-application>**

Uses the identified login module configured in `conf/login-module.xml` and other connection

request information supplied by the application, for example JMS Queues and Topics.

### Parameters for XA Recovery in the JCA Layer

#### `<recover-user-name>`

The user with credentials to perform a recovery operation.

#### `<recover-password>`

Password of the user with credentials to perform a recovery operation.

#### `<recover-security-domain>`

Security domain for recovery.

#### `<no-recover>`

Excludes a datasource from recovery.

The fields in [Parameters for XA Recovery in the JCA Layer](#) should have a fall back value of their non-recover counterparts: `<user-name>`, `<password>` and `<security-domain>`.

## 17.3. DATASOURCE EXAMPLES

For database-specific examples, see [Appendix B, Vendor-Specific Datasource Definitions](#).

### 17.3.1. Generic Datasource Example

#### Example 17.4. Generic Datasource Example

```

        <datasources>
    <local-tx-datasource>
        <jndi-name>GenericDS</jndi-name>
        <connection-url>[jdbc: url for use with Driver class]</connection-
url>
        <driver-class>[fully qualified class name of java.sql.Driver
implementation]</driver-class>
        <user-name>x</user-name>
        <password>y</password>
        <!-- you can include connection properties that will get passed in
the DriverManager.getConnection(props) call-->
        <!-- look at your Driver docs to see what these might be -->
        <connection-property name="char.encoding">UTF-8</connection-
property>
        <transaction-isolation>TRANSACTION_SERIALIZABLE</transaction-
isolation>

        <!--pooling parameters-->
        <min-pool-size>5</min-pool-size>
        <max-pool-size>100</max-pool-size>
        <blocking-timeout-millis>5000</blocking-timeout-millis>
        <idle-timeout-minutes>15</idle-timeout-minutes>
        <!-- sql to call when connection is created

```

```

<new-connection-sql>some arbitrary sql</new-connection-sql>
-->

<!-- sql to call on an existing pooled connection when it is
obtained from pool
<check-valid-connection-sql>some arbitrary sql</check-valid-
connection-sql>
-->

<set-tx-query-timeout></set-tx-query-timeout>
<query-timeout>300</query-timeout> <!-- maximum of 5 minutes for
queries -->

<!-- pooling criteria. USE AT MOST ONE-->
<!-- If you do not use JAAS login modules or explicit login
getConnection(usr,pw) but rely on user/pw specified above,
do not specify anything here -->

<!-- If you supply the usr/pw from a JAAS login module -->
<security-domain>MyRealm</security-domain>

<!-- if your app supplies the usr/pw explicitly getConnection(usr,
pw) -->
<application-managed-security></application-managed-security>

<!--Anonymous depends elements are copied verbatim into the
ConnectionFactory mbean config-->
<depends>myapp.service:service=DoSomethingService</depends>

</local-tx-datasource>

<!-- you can include regular mbean configurations like this one -->
<mbean code="org.jboss.tm.XidFactory"
name="jboss:service=XidFactory">
  <attribute name="Pad">true</attribute>
</mbean>

<!-- Here's an xa example -->
<xa-datasource>
  <jndi-name>GenericXADS</jndi-name>
  <xa-datasource-class>[fully qualified name of class implementing
javax.sql.XADataSource goes here]</xa-datasource-class>
  <xa-datasource-property name="SomeProperty">SomePropertyValue</xa-
datasource-property>
  <xa-datasource-property
name="SomeOtherProperty">SomeOtherValue</xa-datasource-property>

  <user-name>x</user-name>
  <password>y</password>
  <transaction-isolation>TRANSACTION_SERIALIZABLE</transaction-
isolation>

  <!--pooling parameters-->

```

```

<min-pool-size>5</min-pool-size>
<max-pool-size>100</max-pool-size>
<blocking-timeout-millis>5000</blocking-timeout-millis>
<idle-timeout-minutes>15</idle-timeout-minutes>
<!-- sql to call when connection is created
-->
<new-connection-sql>some arbitrary sql</new-connection-sql>
-->

<!-- sql to call on an existing pooled connection when it is
obtained from pool
<check-valid-connection-sql>some arbitrary sql</check-valid-
connection-sql>
-->

<!-- pooling criteria. USE AT MOST ONE-->
<!-- If you do not use JAAS login modules or explicit login
getConnection(usr,pw) but rely on user/pw specified above,
do not specify anything here -->

<!-- If you supply the usr/pw from a JAAS login module -->
<security-domain></security-domain>

<!-- if your app supplies the usr/pw explicitly getConnection(usr,
pw) -->
<application-managed-security></application-managed-security>

</xa-datasource>

</datasources>

```

### 17.3.2. Configuring a DataSource for Remote Usage

JBoss EAP supports accessing a DataSource from a remote client. See [Example 17.5, “Configuring a DataSource for Remote Usage”](#) for the change that gives the client the ability to look up the DataSource from JNDI, which is to specify `use-java-context=false`.

#### Example 17.5. Configuring a Datasource for Remote Usage

```

<datasources>
  <local-tx-datasource>
    <jndi-name>GenericDS</jndi-name>
    <use-java-context>false</use-java-context>
    <connection-url>...</connection-url>
    ...

```

This causes the DataSource to be bound under the JNDI name `GenericDS` instead of the default of `java:/GenericDS`, which restricts the lookup to the same Virtual Machine as the EAP server.

**NOTE**

Use of the `<use-java-context>` setting is not recommended in a production environment. It requires accessing a connection pool remotely and this can cause unexpected problems, since connections are not serializable. Also, transaction propagation is not supported, since it can lead to connection leaks if unreliability is present, such as in a system crash or network failure. A remote session bean facade is the preferred way to access a datasource remotely.

### 17.3.3. Configuring a Datasource to Use Login Modules

#### Procedure 17.1. Configuring a Datasource to Use Login Modules

1. Add the `<security-domain-parameter>` to the XML file for the datasource.

```
<datasources>
  <local-tx-datasource>
    ...
    <security-domain>MyDomain</security-domain>
    ...
  </local-tx-datasource>
</datasources>
```

2. Add an application policy to the `login-config.xml` file.

The authentication section needs to include the configuration for your login-module. For example, to encrypt the database password, use the `SecureIdentityLoginModule` login module.

```
<application-policy name="MyDomain">
  <authentication>
    <login-module
code="org.jboss.resource.security.SecureIdentityLoginModule"
flag="required">
      <module-option name="username">scott</module-option>
      <module-option name="password">-170dd0fbd8c13748</module-
option>
      <module-option
name="managedConnectionFactoryName">jboss.jca:service=LocalTxCM,name
=OracleDSJAAS</module-option>
    </login-module>
  </authentication>
</application-policy>
```

3. If you plan to fetch the data source connection from a web application, authentication must be enabled for the web application, so that the `Subject` is populated.
4. If users need the ability to connect anonymously, add an additional login module to the application-policy, to populate the security credentials.
5. Add the `UsersRolesLoginModule` module to the beginning of the chain. The `usersProperties` and `rolesProperties` parameters can be directed to dummy files.

```
<login-module
code="org.jboss.security.auth.spi.UsersRolesLoginModule"
```

```
flag="required">
  <module-option name="unauthenticatedIdentity">nobody</module-
option>
  <module-option
name="usersProperties">props/users.properties</module-option>
  <module-option
name="rolesProperties">props/roles.properties</module-option>
</login-module>
```

## CHAPTER 18. POOLING

### 18.1. STRATEGY

JCA uses a `ManagedConnectionPool` to perform the pooling. The `ManagedConnectionPool` is made up of subpools depending upon the strategy chosen and other pooling parameters.

XML	mbean	Internal Name	Description
	ByNothing	OnePool	A single pool of equivalent connections
<application-managed-security/>	ByApplication	PoolByCRI	Use the connection properties from <code>allocateConnection()</code>
<security-domain/>	ByContainer	PoolBySubject	A pool per Subject, e.g. preconfigured or EJB/Web log in subjects
<security-domain-and-application/>	ByContainerAndApplication	PoolBySubjectAndCri	A per Subject and connection property combination

For <security-domain-and-application/> the **Subject** always overrides any user/password from `createConnection(user, password)` in the CRI:

```
(
  ConnectionRequestInfo
)
```

### 18.2. WORKAROUND FOR ORACLE'S JDK

Oracle's JDK does not work well with XA connections when used both inside and outside a JTA transaction. To workaround the problem you can create separate sub-pools for the different contexts using <no-tx-separate-pools/>.

### 18.3. POOL ACCESS

The pool is designed for concurrent usage.

Up to <max-pool-size/> threads can be inside the pool at the same time (or using connections from a pool).

Once this limit is reached, threads wait for the <blocking-timeout-seconds/> to use the pool before throwing a `No Managed Connections Available` exception. More information about this exception can be found at <http://www.jboss.org/community/wiki/WhatDoesTheMessageNoManagedConnectionsAvailableMean>.

You may need to use the <allocation-retry/> and <allocation-retry-wait-millis/> elements to have the pool retry to obtain a connection before throwing the exception.



## 18.4. POOL FILLING

The number of connections in the pool is controlled by the pool sizes.

- `<min-pool-size/>` - When the number of connections falls below this size, new connections are created
- `<max-pool-size/>` - No more than this number of connections are created
- `<prefill/>` - Feature Request has been implemented for 4.0.5.

The pool filling is done by a separate "Pool Filler" thread rather than blocking application threads.



### IMPORTANT

Connection pools are filled to their *min-pool-size* only on their first usage.

## 18.5. IDLE CONNECTIONS

You can configure connections to be closed when they are idle. For example; if you just had a peak period and now want to reap the unused ones. This is done via the *idle-timeout-minutes* parameter.

Idle checking is done on a separate *Idle Remover* thread on an 'least recently used' (LRU) basis.

Idle connections (connections that have been unused for the period defined by *idle-timeout-minutes*) are purged regularly. The check is performed at an interval that is half of the *idle-timeout-minutes* value.

The pool itself operates on an 'most recently used' (MRU) basis. This allows the excess connections to be easily identified.

Should closing idle connections cause the pool to fall below the *min-pool-size* value, new connections are created.



### NOTE

If you have long-running transactions and you use interleaving (i.e. do not track-connection-by-tx) make sure the idle timeout is greater than the transaction timeout. When interleaving the connection is returned to the pool for others to use. If however nobody does use it, it would be a candidate for removal before the transaction is committed.

## 18.6. DEAD CONNECTIONS

The JDBC protocol does not provide a natural `connectionErrorOccured()` event when a connection is broken. To support dead/broken connection checking there are a number of plug-ins.

### 18.6.1. Valid connection checking

Valid connections can be checked with an SQL statement (as shown below) before handing the connection to the application.

```
<check-valid-connection-sql>select 1 from dual</check-valid-connection-sql>
```

If this fails, another connection is selected until there are no more connections at which point new connections are constructed.

A potentially more performant check is to use vendor specific features, for example Oracle or MySQL's `pingDatabase()` tool:

```
<valid-connection-checker-class-name/>
```

### 18.6.2. Errors during SQL queries

You can check if a connection broke during a query by the reviewing the error codes or messages of the `SQLException` for **FATAL** errors rather than normal `SQLExceptions`. These codes or messages can be vendor specific, such as:

```
<exception-sorter-class-name>org.jboss.resource.adapter.jdbc.vendor.OracleExceptionSorter</exception-sorter-class-name>
```

For **FATAL** errors, the connection will be closed.

### 18.6.3. Changing, Closing or Flushing the pool

To change, close or flush the pool, do the following:

#### Procedure 18.1. Changing or Flushing the pool

1. Use JMX to change the attributes on the connection pool  
`jdbc:jboss:jca:service=JBossManagedConnectionPool,name=<jndi-name>`.
2. Use JMX to invoke `flush()` to reset the pools.

Also, closing or undeploying the pool will force a flush first.

When `flush()` is invoked;

- All idle connections are immediately closed;
- Any in use connections are closed when the application finishes with them;
- New connections are created.

### 18.6.4. Using Third Party Pools

If you want to use an `XADataSource`, the JBoss JCA can use the standard API.

If it is a **non-`XADataSource`** that does internal pooling (such as Oracle's `DataSource` for use with RAC), then the pool will not understand the transacting or security configurations (nor any other component that expects the connection to be controlled by the JCA).

These `DataSources` are intended for use outside a J2EE environment.

JBoss uses standard JDBC drivers and adds the behaviour to turn them into DataSources with the full J2EE contract.

Non-*XDataSource* datasources should only be used by administrators with a thorough understanding of the topic and its inherent problems.

## **PART III. CLUSTERING GUIDE**

## CHAPTER 19. INTRODUCTION AND QUICK START

Clustering allows you to run an application on several parallel servers (a.k.a cluster nodes) while providing a single view to application clients. Load is distributed across different servers, and even if one or more of the servers fails, the application is still accessible via the surviving cluster nodes. Clustering is crucial for scalable enterprise applications, as you can improve performance by adding more nodes to the cluster. Clustering is crucial for highly available enterprise applications, as it is the clustering infrastructure that supports the redundancy needed for high availability.

The JBoss Enterprise Application Platform comes with clustering support out of the box, as part of the **production** server profile. The **production** server profile includes support for the following:

- A scalable, fault-tolerant JNDI implementation (HA-JNDI).
- Web tier clustering, including:
  - High availability for web session state via state replication.
  - Ability to integrate with hardware and software load balancers, including special integration with `mod_jk` and other JK-based software load balancers.
  - Single Sign-on support across a cluster.
- EJB session bean clustering, for both stateful and stateless beans, and for both EJB3 and EJB2.
- A distributed cache for JPA/Hibernate entities.
- A framework for keeping local EJB2 entity caches consistent across a cluster by invalidating cache entries across the cluster when a bean is changed on any node.
- Distributed JMS queues and topics via JBoss Messaging.
- Deploying a service or application on multiple nodes in the cluster but having it active on only one (but at least one) node is called a *HA Singleton*.
- Keeping deployed content in sync on all nodes in the cluster via the **Farm** service.

In this *Clustering Guide* we aim to provide you with an in depth understanding of how to use JBoss Enterprise Application Platform's clustering features. In this first part of the guide, the goal is to provide some basic "Quick Start" steps to encourage you to start experimenting with JBoss Enterprise Application Platform Clustering, and then to provide some background information that will allow you to understand how JBoss Enterprise Application Platform Clustering works. The next part of the guide then explains in detail how to use these features to cluster your JEE services. Finally, we provide some more details about advanced configuration of JGroups and JBoss Cache, the core technologies that underlie JBoss Enterprise Application Platform Clustering.

### 19.1. QUICK START GUIDE

The goal of this section is to give you the minimum information needed to let you get started experimenting with JBoss Enterprise Application Platform Clustering. Most of the areas touched on in this section are covered in much greater detail later in this guide.

#### 19.1.1. Initial Preparation

Preparing a set of servers to act as a JBoss Enterprise Application Platform cluster involves a few simple steps:

- **Install JBoss Enterprise Application Platform on all your servers.** In its simplest form, this is just a matter of unzipping the JBoss download onto the file system on each server.

If you want to run multiple JBoss Enterprise Application Platform instances on a single server, you can either install the full JBoss distribution onto multiple locations on your file system, or you can simply make copies of the `production` server profile. For example, assuming the root of the JBoss distribution was unzipped to `/var/jboss`, you would:

```
$ cd /var/jboss/server
$ cp -r production node1
$ cp -r production node2
```

- **For each node, determine the address to bind sockets to.** When you start JBoss, whether clustered or not, you need to tell JBoss on what address its sockets should listen for traffic. (The default is `localhost` which is secure but is not very useful, particularly in a cluster.) So, you need to decide what those addresses will be.
- **Ensure multicast is working.** By default JBoss Enterprise Application Platform uses UDP multicast for most intra-cluster communications. Make sure each server's networking configuration supports multicast and that multicast support is enabled for any switches or routers between your servers. If you are planning to run more than one node on a server, make sure the server's routing table includes a multicast route. See the JGroups documentation at <http://www.jgroups.org> for more on this general area, including information on how to use JGroups' diagnostic tools to confirm that multicast is working.



#### NOTE

JBoss Enterprise Application Platform clustering does not require the use of UDP multicast; the Enterprise Application Platform can also be reconfigured to use TCP unicast for intra-cluster communication.

- **Determine a unique integer "ServerPeerID" for each node.** This is needed for JBoss Messaging clustering, and can be skipped if you will not be running JBoss Messaging (that is, you will remove JBM from the server profile's `deploy` directory). JBM requires that each node in a cluster has a unique integer ID, known as a "ServerPeerID", that should remain consistent across server restarts.



#### IMPORTANT

A simple 1, 2, 3, ..., x naming scheme is acceptable, however the value must be between the range 0 to 1023. Values outside this range will result in a `java.lang.IllegalArgumentException` with the `ServerPeer` start Service.

We will cover how to use the `ServerPeerID` in [Section 19.1.2, "Launching a JBoss Enterprise Application Platform Cluster"](#).

Beyond the above required steps, the following two optional steps are recommended to help ensure that your cluster is properly isolated from other JBoss Enterprise Application Platform clusters that may be running on your network:

- **Pick a unique name for your cluster.** The default name for a JBoss Enterprise Application

Platform cluster is "DefaultPartition". Come up with a different name for each cluster in your environment, e.g. "QAPartition" or "BobsDevPartition". The use of "Partition" is not required; it's just a semi-convention. As a small aid to performance try to keep the name short, as it gets included in every message sent around the cluster. We will cover how to use the name you pick in the next section.

- **Pick a unique multicast address for your cluster.** By default JBoss Enterprise Application Platform uses UDP multicast for most intra-cluster communication. Pick a different multicast address for each cluster you run. Generally a good multicast address is of the form `239.255.x.y`. We will cover how to use the address you pick in the next section.

See [Section 28.6.2, "Isolating JGroups Channels"](#) for more on isolating clusters.

## 19.1.2. Launching a JBoss Enterprise Application Platform Cluster

The simplest way to start a server cluster is to start several JBoss instances on the same local network, using the `-c production` command line option for each instance. Those server instances will detect each other and automatically form a cluster.

Let us look at a few different scenarios for doing this. In each scenario we will be creating a two node cluster, where the `ServerPeerID` for the first node is `1` and for the second node is `2`. We've decided to call our cluster "DocsPartition" and to use `239.255.100.100` as our multicast address. These scenarios are meant to be illustrative; the use of a two node cluster should not be taken to mean that is the best size for a cluster; it's just that's the simplest way to do the examples.

- **Scenario 1: Nodes on Separate Machines**

This is the most common production scenario. Assume the machines are named "node1" and "node2", while node1 has an IP address of `192.168.0.101` and node2 has an address of `192.168.0.102`. Assume the "ServerPeerID" for node1 is `1` and for node2 it's `2`. Assume on each machine JBoss is installed in `/var/jboss`.

On node1, to launch JBoss:

```
$ cd /var/jboss/bin
$ ./run.sh -c production -g DocsPartition -u 239.255.100.100 \
  -b 192.168.0.101 -Djboss.messaging.ServerPeerID=1
```

On node2, it's the same except for a different `-b` value and `ServerPeerID`:

```
$ cd /var/jboss/bin
$ ./run.sh -c production -g DocsPartition -u 239.255.100.100 \
  -b 192.168.0.102 -Djboss.messaging.ServerPeerID=2
```

The `-c` switch says to use the `production` config, which includes clustering support. The `-g` switch sets the cluster name. The `-u` switch sets the multicast address that will be used for intra-cluster communication. The `-b` switch sets the address on which sockets will be bound. The `-D` switch sets system property `jboss.messaging.ServerPeerID`, from which JBoss Messaging gets its unique id.

- **Scenario 2: Two Nodes on a Single, Multihomed, Server**

Running multiple nodes on the same machine is a common scenario in a development environment, and is also used in production in combination with Scenario 1. (Running *all* the nodes in a production cluster on a single machine is generally not recommended, since the

machine itself becomes a single point of failure.) In this version of the scenario, the machine is multihomed, i.e. has more than one IP address. This allows the binding of each JBoss instance to a different address, preventing port conflicts when the nodes open sockets.

Assume the single machine has the `192.168.0.101` and `192.168.0.102` addresses assigned, and that the two JBoss instances use the same addresses and `ServerPeerIDs` as in Scenario 1. The difference from Scenario 1 is we need to be sure each Enterprise Application Platform instance has its own work area. So, instead of using the `production` config, we are going to use the `node1` and `node2` configs we copied from `production` earlier in the previous section.

To launch the first instance, open a console window and:

```
$ cd /var/jboss/bin
$ ./run.sh -c node1 -g DocsPartition -u 239.255.100.100 \
  -b 192.168.0.101 -Djboss.messaging.ServerPeerID=1
```

For the second instance, it's the same except for different `-b` and `-c` values and a different `ServerPeerID`:

```
$ cd /var/jboss/bin
$ ./run.sh -c node2 -g DocsPartition -u 239.255.100.100 \
  -b 192.168.0.102 -Djboss.messaging.ServerPeerID=2
```

### ● Scenario 3: Two Nodes on a Single, Non-Multihomed, Server

This is similar to Scenario 2, but here the machine only has one IP address available. Two processes can not bind sockets to the same address and port, so we will have to tell JBoss to use different ports for the two instances. This can be done by configuring the `ServiceBindingManager` service by setting the `jboss.service.binding.set` system property.

To launch the first instance, open a console window and:

```
$ cd /var/jboss/bin
$ ./run.sh -c node1 -g DocsPartition -u 239.255.100.100 \
  -b 192.168.0.101 -Djboss.messaging.ServerPeerID=1 \
  -Djboss.service.binding.set=ports-default
```

For the second instance:

```
$ cd /var/jboss/bin
$ ./run.sh -c node2 -g DocsPartition -u 239.255.100.100 \
  -b 192.168.0.101 -Djboss.messaging.ServerPeerID=2 \
  -Djboss.service.binding.set=ports-01
```

This tells the `ServiceBindingManager` on the first node to use the standard set of ports (e.g. JNDI on 1099). The second node uses the "ports-01" binding set, which by default for each port has an offset of 100 from the standard port number (e.g. JNDI on 1199). See the `conf/bindingservice.beans/META-INF/bindings-jboss-beans.xml` file for the full `ServiceBindingManager` configuration.

Note that this setup is not advised for production use, due to the increased management complexity that comes with using different ports. But it is a fairly common scenario in



development environments where developers want to use clustering but cannot multihome their workstations.



## NOTE

Including `-Djboss.service.binding.set=ports-default` on the command line for `node1` is not technically necessary, since `ports-default` is the default value. But using a consistent set of command line arguments across all servers is helpful to people less familiar with all the details.

That's it; that's all it takes to get a cluster of JBoss Enterprise Application Platform servers up and running.

### 19.1.3. Web Application Clustering Quick Start

JBoss Enterprise Application Platform supports clustered web sessions, where a backup copy of each user's `HttpSession` state is stored on one or more nodes in the cluster. In case the primary node handling the session fails or is shut down, any other node in the cluster can handle subsequent requests for the session by accessing the backup copy. Web tier clustering is discussed in detail in the *HTTP Connectors Load Balancing Guide*

There are two aspects to setting up web tier clustering:

- **Configuring an External Load Balancer** . Web applications require an external load balancer to balance HTTP requests across the cluster of JBoss Enterprise Application Platform instances (see [Section 20.2.2, “External Load Balancer Architecture”](#) for more on why that is). JBoss Enterprise Application Platform itself does not act as an HTTP load balancer. So, you will need to set up a hardware or software load balancer. There are many possible load balancer choices, so how to configure one is really beyond the scope of a Quick Start. Refer to the *HTTP Connectors Load Balancing Guide* for details on how to set up the popular `mod_jk` software load balancer.
- **Configuring Your Web Application for Clustering** . This aspect involves telling JBoss you want clustering behavior for a particular web app, and it could not be simpler. Just add an empty `distributable` element to your application's `web.xml` file:

```
<?xml version="1.0"?>
<web-app xmlns="http://java.sun.com/xml/ns/javaee"
         xmlns:xsi="http://www.w3.org/2001/XMLSchema-instance"
         xsi:schemaLocation="http://java.sun.com/xml/ns/javaee
         http://java.sun.com/xml/ns/javaee/web-app_2_5.xsd"
         version="2.5">

    <distributable/>

</web-app>
```

Simply doing that is enough to get the default JBoss Enterprise Application Platform web session clustering behavior, which is appropriate for most applications. Refer to the *HTTP Connectors Load Balancing Guide* for more advanced configuration options.

### 19.1.4. EJB Session Bean Clustering Quick Start

JBoss Enterprise Application Platform supports clustered EJB session beans, whereby requests for a bean are balanced across the cluster. For stateful beans a backup copy of bean state is maintained on one or more cluster nodes, providing high availability in case the node handling a particular session fails or is shut down. Clustering of both EJB2 and EJB3 beans is supported.

For EJB3 session beans, simply add the `org.jboss.ejb3.annotation.Clustered` annotation to the bean class for your stateful or stateless bean:

```
@javax.ejb.Stateless
@org.jboss.ejb3.annotation.Clustered
public class MyBean implements MySessionInt {

    public void test() {
        // Do something cool
    }
}
```

For EJB2 session beans, or for EJB3 beans where you prefer XML configuration over annotations, simply add a `clustered` element to the bean's section in the JBoss-specific deployment descriptor, `jboss.xml`:

```
<jboss>
  <enterprise-beans>
    <session>
      <ejb-name>example.StatelessSession</ejb-name>
      <jndi-name>example.StatelessSession</jndi-name>
      <clustered>true</clustered>
    </session>
  </enterprise-beans>
</jboss>
```

See [Chapter 23, Clustered Session EJBs](#) for more advanced configuration options.

### 19.1.5. Entity Clustering Quick Start

One of the big improvements in the clustering area in JBoss Enterprise Application Platform 5 is the use of the new Hibernate/JBoss Cache integration for second level entity caching that was introduced in Hibernate 3.3. In the JPA/Hibernate context, a second level cache refers to a cache whose contents are retained beyond the scope of a transaction. A second level cache *may* improve performance by reducing the number of database reads. You should always load test your application with second level caching enabled and disabled to see whether it has a beneficial impact on your particular application.

If you use more than one JBoss Enterprise Application Platform instance to run your JPA/Hibernate application and you use second level caching, you must use a cluster-aware cache. Otherwise a cache on server A will still hold out-of-date data after activity on server B updates some entities.

JBoss Enterprise Application Platform provides a cluster-aware second level cache based on JBoss Cache. To tell JBoss Enterprise Application Platform's standard Hibernate-based JPA provider to enable second level caching with JBoss Cache, configure your `persistence.xml` as follows:

```
<?xml version="1.0" encoding="UTF-8"?>
<persistence xmlns="http://java.sun.com/xml/ns/persistence"
  xmlns:xsi="http://www.w3.org/2001/XMLSchema-instance"
  xsi:schemaLocation="http://java.sun.com/xml/ns/persistence
  http://java.sun.com/xml/ns/persistence/persistence_1_0.xsd"
```

```

version="1.0">
<persistence-unit name="somename" transaction-type="JTA">
  <jta-data-source>java:/SomeDS</jta-data-source>
  <properties>
    <property name="hibernate.cache.use_second_level_cache"
value="true"/>
    <property name="hibernate.cache.region.factory_class"
value="org.hibernate.cache.jbc2.JndiMultiplexedJBossCacheRegionFactory"/>
    <property name="hibernate.cache.region.jbc2.cachefactory"
value="java:CacheManager"/>
    <!-- Other configuration options ... -->
  </properties>
</persistence-unit>
</persistence>

```

That tells Hibernate to use the JBoss Cache-based second level cache, but it does not tell it what entities to cache. That can be done by adding the `org.hibernate.annotations.Cache` annotation to your entity class:

```

package org.example.entities;

import java.io.Serializable;
import javax.persistence.Entity;
import org.hibernate.annotations.Cache;
import org.hibernate.annotations.CacheConcurrencyStrategy;

@Entity
@Cache(usage=CacheConcurrencyStrategy.TRANSACTIONAL)
public class Account implements Serializable {

```

See [Chapter 24, Clustered Entity EJBs](#) for more advanced configuration options and details on how to configure the same thing for a non-JPA Hibernate application.



## NOTE

Clustering can add significant overhead to a JPA/Hibernate second level cache, so do not assume that just because second level caching adds a benefit to a non-clustered application that it will be beneficial to a clustered application. Even if clustered second level caching is beneficial overall, caching of more frequently modified entity types may be beneficial in a non-clustered scenario but not in a clustered one. *Always* load test your application.

## CHAPTER 20. CLUSTERING CONCEPTS

In the next section, we discuss basic concepts behind JBoss' clustering services. It is helpful that you understand these concepts before reading the rest of the *Clustering Guide*.

### 20.1. CLUSTER DEFINITION

A cluster is a set of nodes that communicate with each other and work toward a common goal. In a JBoss Enterprise Application Platform cluster (also known as a “partition”), a node is an JBoss Enterprise Application Platform instance. Communication between the nodes is handled by the JGroups group communication library, with a JGroups `Channel` providing the core functionality of tracking who is in the cluster and reliably exchanging messages between the cluster members. JGroups channels with the same configuration and name have the ability to dynamically discover each other and form a group. This is why simply executing “`run -c production`” on two Enterprise Application Platform instances on the same network is enough for them to form a cluster – each Enterprise Application Platform starts a `Channel` (actually, several) with the same default configuration, so they dynamically discover each other and form a cluster. Nodes can be dynamically added to or removed from clusters at any time, simply by starting or stopping a `Channel` with a configuration and name that matches the other cluster members.

On the same Enterprise Application Platform instance, different services can create their own `Channel`. In a standard start of the Enterprise Application Platform 5 `production` server profile, two different services create a total of four different channels – JBoss Messaging creates two and a core general purpose clustering service known as HAPartition creates two more. If you deploy clustered web applications, clustered EJB3 SFSBs or a clustered JPA/Hibernate entity cache, additional channels will be created. The channels the Enterprise Application Platform connects can be divided into three broad categories: a general purpose channel used by the HAPartition service, channels created by JBoss Cache for special purpose caching and cluster wide state replication, and two channels used by JBoss Messaging.

So, if you go to two Enterprise Application Platform 5.0.x instances and execute `run -c production`, the channels will discover each other and you'll have a conceptual `cluster`. It's easy to think of this as a two node cluster, but it's important to understand that you really have multiple channels, and hence multiple two node clusters.

On the same network, you may have different sets of servers whose services wish to cluster. [Figure 20.1, “Clusters and server nodes”](#) shows an example network of EAP instances divided into three sets, with the third set only having one node. This sort of topology can be set up simply by configuring the Enterprise Application Platform instances such that within a set of nodes meant to form a cluster the Channel configurations and names match while they differ from any other channel configurations and names match while they differ from any other channels on the same network. The Enterprise Application Platform tries to make this as easy as possible, such that servers that are meant to cluster only need to have the same values passed on the command line to the `-g` (partition name) and `-u` (multicast address) start up switches. For each set of servers, different values should be chosen. The sections on “JGroups Configuration” and “Isolating JGroups Channels” cover in detail how to configure the Enterprise Application Platform such that desired peers find each other and unwanted peers do not.

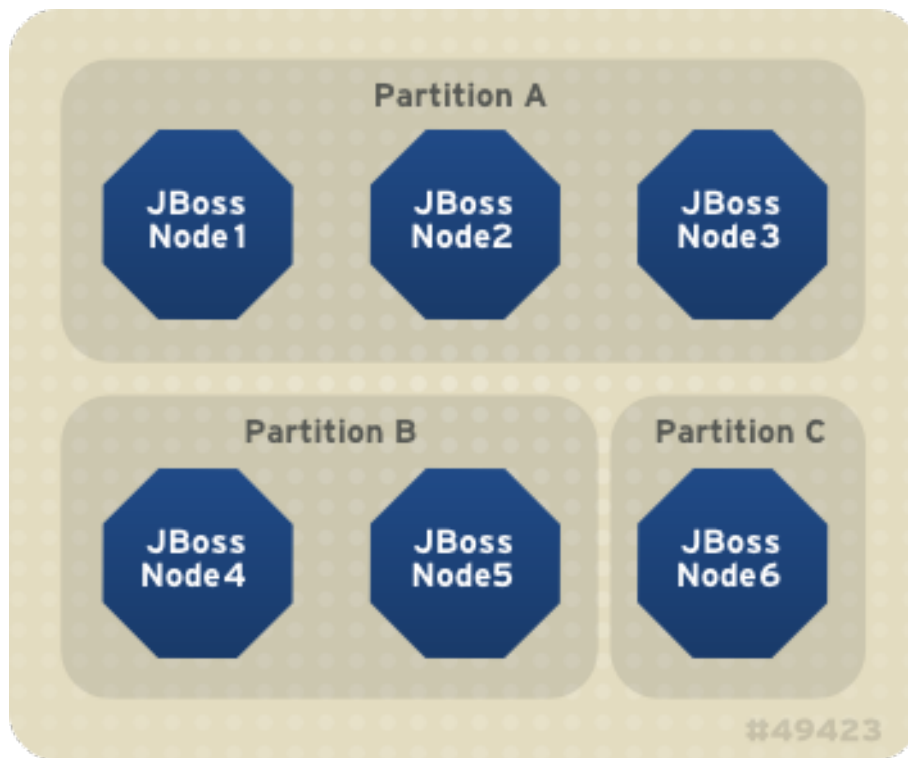

Figure 20.1. Clusters and server nodes

## 20.2. SERVICE ARCHITECTURES

The clustering topography defined by the JGroups configuration on each node is of great importance to system administrators. But for most application developers, the greater concern is probably the cluster architecture from a client application's point of view. Two basic clustering architectures are used with JBoss Enterprise Application Platform: client-side interceptors (a.k.a. smart proxies or stubs) and external load balancers. Which architecture your application will use will depend on what type of client you have.

### 20.2.1. Client-side interceptor architecture

Most remote services provided by the JBoss Enterprise Application Platform, including JNDI, EJB, JMS, RMI and JBoss Remoting, require the client to obtain (for example, to look up and download) a remote proxy object. The proxy object is generated by the server and it implements the business interface of the service. The client then makes local method calls against the proxy object. The proxy automatically routes the call across the network where it is invoked against service objects managed in the server. The proxy object figures out how to find the appropriate server node, marshal call parameters, unmarshal call results, and return the result to the caller client. In a clustered environment, the server-generated proxy object includes an interceptor that understands how to route calls to multiple nodes in the cluster.

The proxy's clustering logic maintains up-to-date knowledge about the cluster. For instance, it knows the IP addresses of all available server nodes, the algorithm to distribute load across nodes (see next section), and how to failover the request if the target node not available. As part of handling each service request, if the cluster topology has changed the server node updates the proxy with the latest changes in the cluster. For instance, if a node drops out of the cluster, each proxy is updated with the new topology the next time it connects to any active node in the cluster. All the manipulations done by the proxy's clustering logic are transparent to the client application. The client-side interceptor clustering architecture is illustrated below:

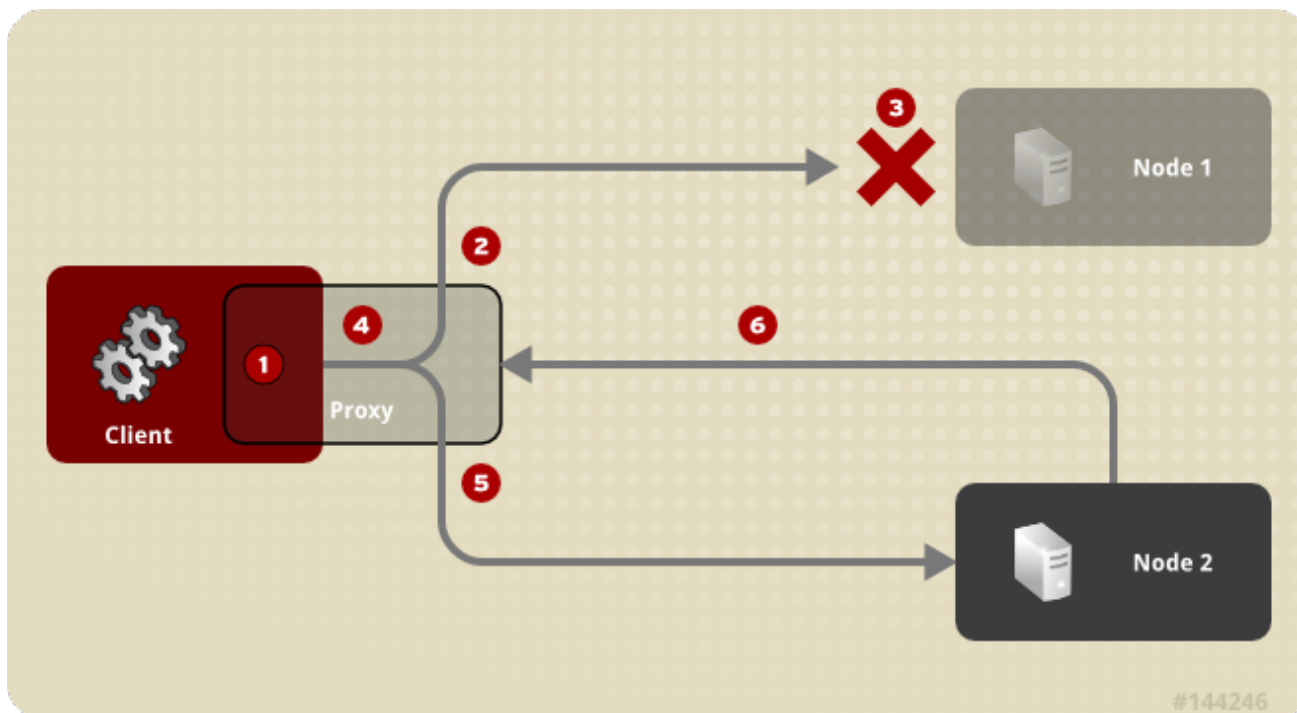

1	Client communicates with proxy
2	Proxy sends request to Node 1
3	Node 1 goes offline
4	Proxy switches to Node 2
5	Proxy sends request to Node 2
6	Proxy downloads class dynamically from Node 2

### 20.2.2. External Load Balancer Architecture

The HTTP-based JBoss services do not require the client to download anything. The client (for example, a web browser) sends in requests and receives responses directly over the wire using the HTTP protocol). In this case, an external load balancer is required to process all requests and dispatch them to server nodes in the cluster. The client only needs to know how to contact the load balancer; it has no knowledge of the JBoss Enterprise Application Platform instances behind the load balancer. The load balancer is logically part of the cluster, but we refer to it as “external” because it is not running in the same process as either the client or any of the JBoss Enterprise Application Platform instances. It can be implemented either in software or hardware. There are many vendors of hardware load balancers; the `mod_jk` Apache module is an excellent example of a software load balancer. An external load balancer implements its own mechanism for understanding the cluster configuration and provides its own load balancing and failover policies. The external load balancer clustering architecture is illustrated below:

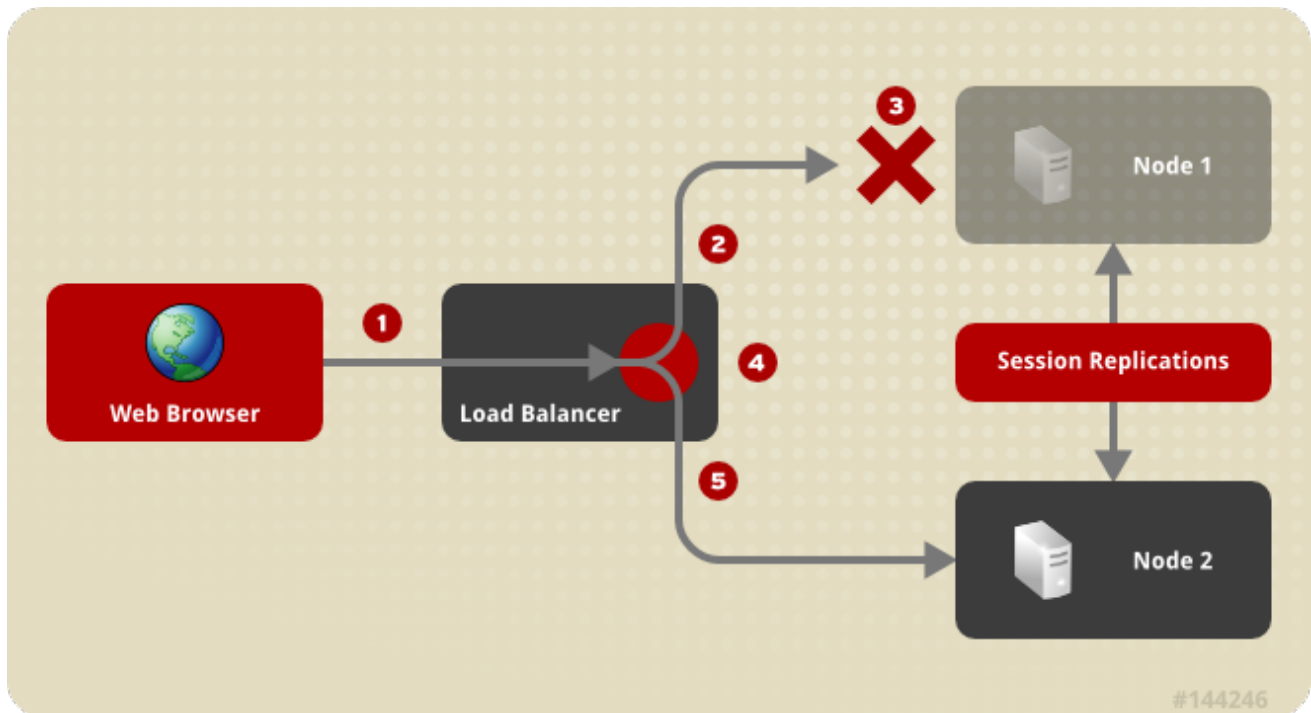

1	Browser sends a request.
2	Load Balancer forwards request to Node 1.
3	Node 1 goes offline.
4	Load Balancer switches to using Node 2.
5	Load Balancer forwards to Node 2.

A potential problem with an external load balancer architecture is that the load balancer itself may be a single point of failure. It needs to be monitored closely to ensure high availability of the entire cluster's services.

## 20.3. LOAD BALANCING POLICIES

Both the JBoss client-side interceptor (stub) and load balancer use load balancing policies to determine to which server node a new request should be sent. In this section, let us go over the load balancing policies available in JBoss Enterprise Application Platform.

### 20.3.1. Client-side interceptor architecture

In JBoss Enterprise Application Platform 5, the following load balancing options are available when the client-side interceptor architecture is used. The client-side stub maintains a list of all nodes providing the target service; the job of the load balance policy is to pick a node from this list for each request. Each policy has two implementation classes, one meant for use by legacy services like EJB2 that use the legacy detached invoker architecture, and the other meant for services like EJB3 that use AOP-based invocations.

- Round-Robin: each call is dispatched to a new node, proceeding sequentially through the list of nodes. The first target node is randomly selected from the list. Implemented by `org.jboss.ha.framework.interfaces.RoundRobin` (legacy) and

`org.jboss.ha.client.loadbalance.RoundRobin` (EJB3).

- Random-Robin: for each call the target node is randomly selected from the list. Implemented by `org.jboss.ha.framework.interfaces.RandomRobin` (legacy) and `org.jboss.ha.client.loadbalance.RandomRobin` (EJB3).
- First Available: one of the available target nodes is elected as the main target and is thereafter used for every call; this elected member is randomly chosen from the list of members in the cluster. When the list of target nodes changes (because a node starts or dies), the policy will choose a new target node unless the currently elected node is still available. Each client-side proxy elects its own target node independently of the other proxies, so if a particular client downloads two proxies for the same target service (for example, an EJB), each proxy will independently pick its target. This is an example of a policy that provides “session affinity” or “sticky sessions”, since the target node does not change once established. Implemented by `org.jboss.ha.framework.interfaces.FirstAvailable` (legacy) and `org.jboss.ha.client.loadbalance.aop.FirstAvailable` (EJB3).
- First Available Identical All Proxies: has the same behavior as the "First Available" policy but the elected target node is shared by all proxies in the same client-side VM that are associated with the same target service. So if a particular client downloads two proxies for the same target service (e.g. an EJB), each proxy will use the same target. Implemented by `org.jboss.ha.framework.interfaces.FirstAvailableIdenticalAllProxies` (legacy) and `org.jboss.ha.client.loadbalance.aop.FirstAvailableIdenticalAllProxies` (EJB3).

Each of the above is an implementation of the `org.jboss.ha.framework.interfaces.LoadBalancePolicy` interface; users are free to write their own implementation of this simple interface if they need some special behavior. In later sections we will see how to configure the load balance policies used by different services.

### 20.3.2. External load balancer architecture

New in JBoss Enterprise Application Platform 5 are a set of "TransactionSticky" load balance policies. These extend the standard policies above to add behavior such that all invocations that occur within the scope of a transaction are routed to the same node (if that node still exists). These are based on the legacy detached invoker architecture, so they are not available for AOP-based services like EJB3.

- Transaction-Sticky Round-Robin: Transaction-sticky variant of Round-Robin. Implemented by `org.jboss.ha.framework.interfaces.TransactionStickyRoundRobin`.
- Transaction-Sticky Random-Robin: Transaction-sticky variant of Random-Robin. Implemented by `org.jboss.ha.framework.interfaces.TransactionStickyRandomRobin`.
- Transaction-Sticky First Available: Transaction-sticky variant of First Available. Implemented by `org.jboss.ha.framework.interfaces.TransactionStickyFirstAvailable`.
- Transaction-Sticky First Available Identical All Proxies: Transaction-sticky variant of First Available Identical All Proxies. Implemented by `org.jboss.ha.framework.interfaces.TransactionStickyFirstAvailableIdenticalAllProxies`.

Each of the above is an implementation of a simple interface; users are free to write their own implementations if they need some special behavior. In later sections we will see how to configure the load balance policies used by different services.



## CHAPTER 21. CLUSTERING BUILDING BLOCKS

The clustering features in JBoss Enterprise Application Platform are built on top of lower level libraries that provide much of the core functionality. [Figure 21.1, “The JBoss Enterprise Application Platform clustering architecture”](#) shows the main pieces:

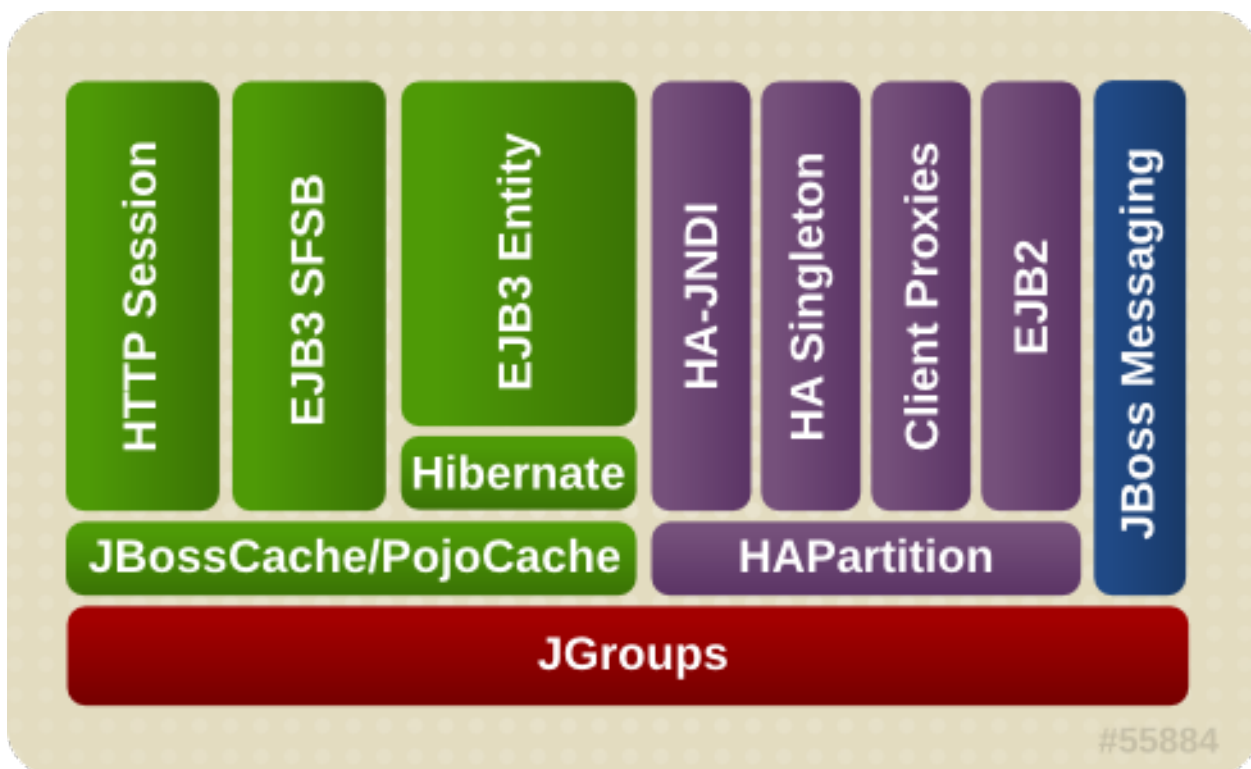

**Figure 21.1.** The JBoss Enterprise Application Platform clustering architecture

**JGroups** is a toolkit for reliable point-to-point and point-to-multipoint communication. JGroups is used for all clustering-related communications between nodes in a JBoss Enterprise Application Platform cluster.

**JBoss Cache** is a highly flexible clustered transactional caching library. Many Enterprise Application Platform clustering services need to cache some state in memory while (1) ensuring for high availability purposes that a backup copy of that state is available on another node if it can not otherwise be recreated (e.g. the contents of a web session) and (2) ensuring that the data cached on each node in the cluster is consistent. JBoss Cache handles these concerns for most JBoss Enterprise Application Platform clustered services. JBoss Cache uses JGroups to handle its group communication requirements. **POJO Cache** is an extension of the core JBoss Cache that JBoss Enterprise Application Platform uses to support fine-grained replication of clustered web session state. See [Section 21.2, “Distributed Caching with JBoss Cache”](#) for more on how JBoss Enterprise Application Platform uses JBoss Cache and POJO Cache.

**HAPartition** is an adapter on top of a JGroups channel that allows multiple services to use the channel. HAPartition also supports a distributed registry of which HAPartition-based services are running on which cluster members. It provides notifications to interested listeners when the cluster membership changes or the clustered service registry changes. See [Section 21.3, “The HAPartition Service”](#) for more details on HAPartition.

The other higher level clustering services make use of JBoss Cache or HAPartition, or, in the case of HA-JNDI, both. The exception to this is JBoss Messaging's clustering features, which interact with JGroups directly.

## 21.1. GROUP COMMUNICATION WITH JGROUPS

JGroups provides the underlying group communication support for JBoss Enterprise Application Platform clusters. Services deployed on JBoss Enterprise Application Platform which need group communication with their peers will obtain a JGroups `Channel` and use it to communicate. The `Channel` handles such tasks as managing which nodes are members of the group, detecting node failures, ensuring lossless, first-in-first-out delivery of messages to all group members, and providing flow control to ensure fast message senders cannot overwhelm slow message receivers.

The characteristics of a JGroups `Channel` are determined by the set of *protocols* that compose it. Each protocol handles a single aspect of the overall group communication task; for example the `UDP` protocol handles the details of sending and receiving UDP datagrams. A `Channel` that uses the `UDP` protocol is capable of communicating with UDP unicast and multicast; alternatively one that uses the `TCP` protocol uses TCP unicast for all messages. JGroups supports a wide variety of different protocols (see [Section 28.1, “Configuring a JGroups Channel's Protocol Stack”](#) for details), but the Enterprise Application Platform ships with a default set of channel configurations that should meet most needs.

By default, all JGroups channels of the Enterprise Application Platform use the UDP multicast (an exception to this is a JBoss Messaging channel, which is TCP-based). To change the default multicast type for a server, in `<JBOSS_HOME>/bin/` create `run.conf`. Open the file and add the following: `JAVA_OPTS="$JAVA_OPTS -Djboss.default.jgroups.stack=<METHOD>".`

### 21.1.1. The Channel Factory Service

A significant difference in JBoss Enterprise Application Platform 5 versus previous releases is that JGroups Channels needed by clustering services (for example, a channel used by a distributed `HttpSession` cache) are no longer configured in detail as part of the consuming service's configuration, and are no longer directly instantiated by the consuming service. Instead, a new `ChannelFactory` service is used as a registry for named channel configurations and as a factory for `Channel` instances. A service that needs a channel requests the channel from the `ChannelFactory`, passing in the name of the desired configuration.

The `ChannelFactory` service is deployed in the `server/production/deploy/cluster/jgroups-channelfactory.sar`. On start up the `ChannelFactory` service parses the `server/production/deploy/cluster/jgroups-channelfactory.sar/META-INF/jgroups-channelfactory-stacks.xml` file, which includes various standard JGroups configurations identified by name (for example, `UDP` or `TCP`). Services needing a channel access the channel factory and ask for a channel with a particular named configuration.



#### NOTE

If several services request a channel with the same configuration name from the `ChannelFactory`, they are not handed a reference to the same underlying `Channel`. Each receives its own `Channel`, but the channels will have an identical configuration. A logical question is how those channels avoid forming a group with each other if each, for example, is using the same multicast address and port. The answer is that when a consuming service connects its `Channel`, it passes a unique-to-that-service `cluster_name` argument to the `Channel.connect(String cluster_name)` method. The `Channel` uses that `cluster_name` as one of the factors that determine whether a particular message received over the network is intended for it.

#### 21.1.1.1. Standard Protocol Stack Configurations

The standard protocol stack configurations that ship with Enterprise Application Platform 5 are

described below. Note that not all of these are actually used; many are included as a convenience to users who may wish to alter the default server profile. The configurations actually used in a stock Enterprise Application Platform 5 **production** server profile are **udp**, **jbm-control** and **jbm-data**, with all clustering services other than JBoss Messaging using **udp**.

You can add a new stack configuration by adding a new **stack** element to the **server/production/deploy/cluster/jgroups-channelfactory.sar/META-INF/jgroups-channelfactory-stacks.xml** file. You can alter the behavior of an existing configuration by editing this file. Before doing this though, have a look at the other standard configurations the Enterprise Application Platform ships; perhaps one of those meets your needs. Also, please note that before editing a configuration you should understand what services are using that configuration; make sure the change you are making is appropriate for all affected services. If the change is not appropriate for a particular service, create a new configuration and change some services to use that new configuration.

- **udp**

UDP multicast based stack meant to be shared between different channels. Message bundling is disabled, as it can add latency to synchronous group RPCs. Services that only make asynchronous RPCs (for example, JBoss Cache configured for **REPL\_ASYNC**) and do so in high volume may be able to improve performance by configuring their cache to use the **udp-async** stack below. Services that only make synchronous RPCs (for example JBoss Cache configured for **REPL\_SYNC** or **INVALIDATION\_SYNC**) may be able to improve performance by using the **udp-sync** stack below, which does not include flow control.

- **udp-async**

Same as the default **udp** stack above, except message bundling is enabled in the transport protocol (**enable\_bundling=true**). Useful for services that make high-volume asynchronous RPCs (e.g. high volume JBoss Cache instances configured for **REPL\_ASYNC**) where message bundling may improve performance.

- **udp-sync**

UDP multicast based stack, without flow control and without message bundling. This can be used instead of **udp** if (1) synchronous calls are used and (2) the message volume (rate and size) is not that large. Do not use this configuration if you send messages at a high sustained rate, or you might run out of memory.

- **tcp**

TCP based stack, with flow control and message bundling. TCP stacks are usually used when IP multicasting cannot be used in a network (e.g. routers discard multicast).

- **tcp-sync**

TCP based stack, without flow control and without message bundling. TCP stacks are usually used when IP multicasting cannot be used in a network (e.g. routers discard multicast). This configuration should be used instead of **tcp** above when (1) synchronous calls are used and (2) the message volume (rate and size) is not that large. Do not use this configuration if you send messages at a high sustained rate, or you might run out of memory.

- **jbm-control**

Stack optimized for the JBoss Messaging Control Channel. By default uses the same UDP transport protocol configuration as is used for the default **udp** stack defined above. This allows

the JBoss Messaging Control Channel to use the same sockets, network buffers and thread pools as are used by the other standard JBoss Enterprise Application Platform clustered services (see [Section 21.1.2, “The JGroups Shared Transport”](#))

- **jbm-data**

TCP-based stack optimized for the JBoss Messaging Data Channel.

### 21.1.1.2. Changing the Protocol Stack Configuration

By default, all clustering services other than JBoss Messaging use the `udp` protocol stack configuration. If you want to use a TCP-based configuration, set the system property `jboss.default.jgroups.stack` to the `tcp` value (`-Djboss.default.jgroups.stack=tcp`). This change configures most of the services that use a JGroups channel to use the TCP-based configuration. To make `tcp` the default protocol stack, add the system property to the `JAVA_OPTS` environment variable in the `<JBOSS_HOME>/bin/run.conf` file on Linux platforms or `<JBOSS_HOME>/bin/run.conf.bat` on Windows platforms.

The `tcp` stack uses UDP multicast (via the MPING layer) for peer discovery. This allows the stack to avoid environment-specific configuration of hosts and work out of the box. If you cannot use UDP multicast, you need to change to a non-UDP-based peer-discovery layer (the TCPPING layer) and configure the addresses/ports of the possible cluster nodes. You can change the protocol stack configuration in `jgroups-channelFactory-stacks.xml`. The file contains definitions for both peer-discovery layers: by default, the definition of MPING layer is uncommented and the TCPPING layer is commented. To switch to non-UDP based peer-discovery, comment out the MPING layer, and uncomment and configure the TCPPING layer. For more information on MPING and TCPPING, refer to [Section 28.1.3, “Discovery Protocols”](#).

### 21.1.1.3. Changing the Protocol Stack Configuration of JBoss Messaging

JBoss Messaging uses the `jbm-control` and `jbm-data` protocol stack configurations by default. The `jbm-control` protocol stack is fully UDP-based and `jbm-data` uses the MPING discovery protocol, which uses UDP multicast. Therefore, if you want JBoss Messaging to use only TCP-based configurations, you need to configure the JBoss Messaging control channel to use the `tcp` protocol stack instead of the `jbm-control` stack and modify the `jbm-data` protocol stack to use TCPPING layer instead of the MPING layer.

To configure the JBoss Messaging control channel to use the `tcp` protocol stack, open the `deploy/messaging/RDMS-persistence-service.xml` file (the `RDMS` value depends on the relational database management system you are using for message persistence) and change the `ControlChannelName` attribute value of the `org.jboss.messaging.core.jmx.MessagingPostOfficeService` mbean to `tcp`:

```
<!--<attribute name="ControlChannelName">jbm-control</attribute-->
<attribute name="ControlChannelName">tcp</attribute>
```

To modify the `jbm-data` protocol stack definition so that it uses the TCPPING layer instead of the MPING layer, open `/server/PROFILE/deploy/cluster/jgroups-channelFactory.sar/META-INF/jgroups-channelFactory-stacks.xml` and replace the MPING layer with an equivalent TCPPING layer as shown in [Example 21.1, “Definition of the jbm-data protocol stack with TCPPING definition”](#).

#### Example 21.1. Definition of the jbm-data protocol stack with TCPPING definition

```
<!--
```

```

<MPING timeout="3000"
  num_initial_members="3"
  mcast_addr="${jboss.jgroups.tcp.mping_mcast_addr:230.11.11.11}"
  mcast_port="${jgroups.tcp.mping_mcast_port:45700}"
  ip_ttl="${jgroups.udp.ip_ttl:2}"/>
-->
<TCPPING timeout="5000"

initial_hosts="${jbm.data.tcpping.initial_hosts:localhost[7900],localhos
t[7901]}"
  port_range="1"
  num_initial_members="3"/>

```

Make sure the defined ports do not conflict with ports used by other TCPPING layers. You can also use the system property `-Djbm.data.tcpping.initial_hosts` to configure the set of initial hosts for this layer from `JAVA_OPTS`.

### 21.1.2. The JGroups Shared Transport

As the number of JGroups-based clustering services running in the Enterprise Application Platform has risen over the years, the need to share the resources (particularly sockets and threads) used by these channels became a glaring problem. A stock Enterprise Application Platform 5 **production** configuration will connect 4 JGroups channels during start up, and a total of 7 or 8 will be connected if distributable web apps, clustered EJB3 SFSBs and a clustered JPA/Hibernate second level cache are all used. So many channels can consume a lot of resources, and can be a real configuration nightmare if the network environment requires configuration to ensure cluster isolation.

Beginning with Enterprise Application Platform 5, JGroups supports sharing of transport protocol instances between channels. A JGroups channel is composed of a stack of individual protocols, each of which is responsible for one aspect of the channel's behavior. A transport protocol is a protocol that is responsible for actually sending messages on the network and receiving them from the network. The resources that are most desirable for sharing (sockets and thread pools) are managed by the transport protocol, so sharing a transport protocol between channels efficiently accomplishes JGroups resource sharing.

To configure a transport protocol for sharing, simply add a `singleton_name="someName"` attribute to the protocol's configuration. All channels whose transport protocol configuration uses the same `singleton_name` value will share their transport. All other protocols in the stack will not be shared. [Figure 21.2, "Services using a Shared Transport"](#) illustrates 4 services running in a VM, each with its own channel. Three of the services are sharing a transport; the fourth is using its own transport.

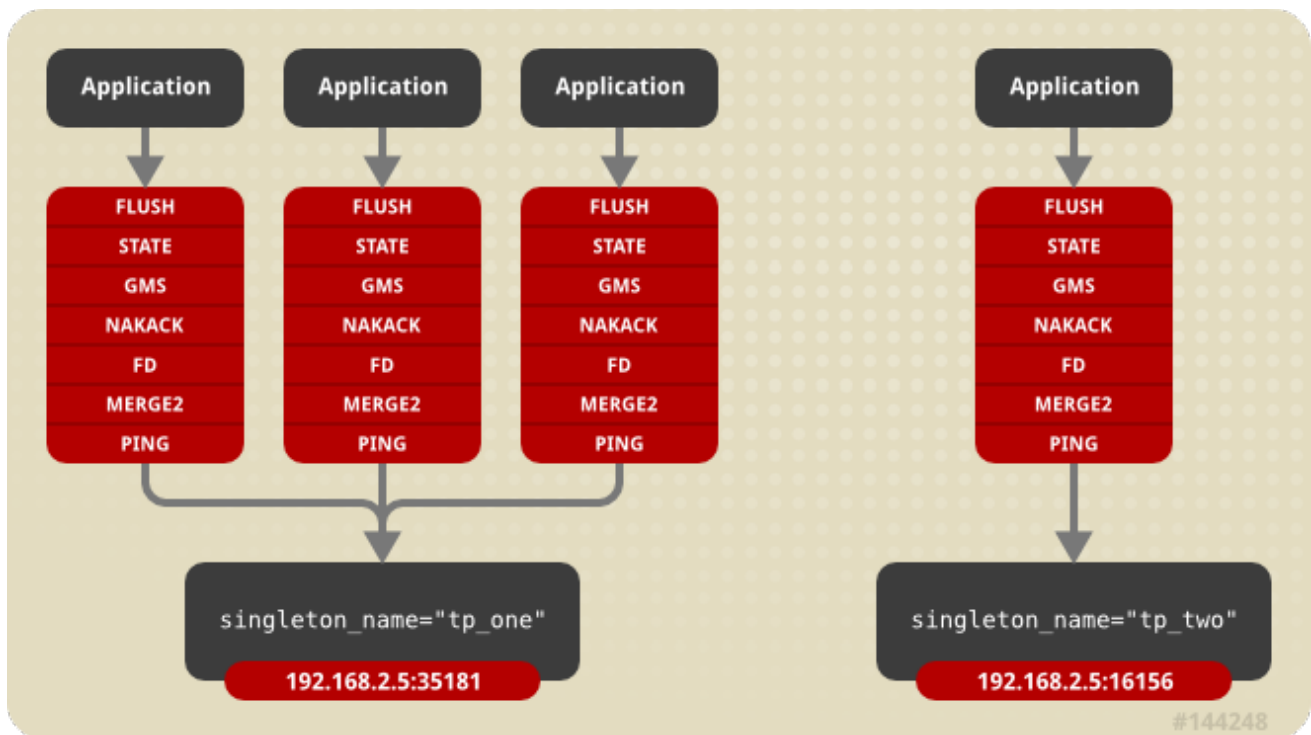

Figure 21.2. Services using a Shared Transport

The protocol stack configurations used by the Enterprise Application Platform 5 ChannelFactory all have a `singleton_name` configured. In fact, if you add a stack to the ChannelFactory that does not include a `singleton_name`, before creating any channels for that stack, the ChannelFactory will synthetically create a `singleton_name` by concatenating the stack name to the string "unnamed\_", e.g. `unnamed_customStack`.

## 21.2. DISTRIBUTED CACHING WITH JBOSS CACHE

JBoss Cache is a fully featured distributed cache framework that can be used in any application server environment or standalone.



### IMPORTANT

JBoss Cache is deprecated and will be removed in the next release. The feature will be substituted by Infinispan.

JBoss Cache provides the underlying distributed caching support used by many of the standard clustered services in a JBoss Enterprise Application Platform cluster, including:

- replication of clustered webapp sessions
- replication of clustered EJB3 Stateful Session beans
- clustered caching of JPA and Hibernate entities
- clustered Single Sign-On
- the HA-JNDI replicated tree
- DistributedStateService

Users can also create their own JBoss Cache and POJO Cache instances for custom use by their applications, see [Chapter 29, JBoss Cache Configuration and Deployment](#) for more on this.

### 21.2.1. The JBoss Enterprise Application Platform CacheManager Service

Many of the standard clustered services in JBoss Enterprise Application Platform use JBoss Cache to maintain consistent state across the cluster. Different services (e.g. web session clustering or second level caching of JPA/Hibernate entities) use different JBoss Cache instances, with each cache configured to meet the needs of the service that uses it. In Enterprise Application Platform 4, each of these caches was independently deployed in the `deploy/` directory, which had a number of disadvantages:

- Caches that end user applications did not need were deployed anyway, with each creating an expensive JGroups channel. For example, even if there were no clustered EJB3 SFSBs, a cache to store them was started.
- Caches are internal details of the services that use them. They should not be first-class deployments.
- Services would find their cache via JMX look ups. Using JMX for purposes other than exposing management interfaces is just not the JBoss Enterprise Application Platform 5 way.

In JBoss Enterprise Application Platform 5, the scattered cache deployments have been replaced with a new **CacheManager** service, deployed via the `<JBOSS_HOME>/server/<PROFILE>/deploy/cluster/jboss-cache-manager.sar`. The CacheManager is a factory and registry for JBoss Cache instances. It is configured with a set of named JBoss Cache configurations. Services that need a cache ask the cache manager for the cache by name; the cache manager creates the cache (if not already created) and returns it. The cache manager keeps a reference to each cache it has created, so all services that request the same cache configuration name will share the same cache. When a service is done with the cache, it releases it to the cache manager. The cache manager keeps track of how many services are using each cache, and will stop and destroy the cache when all services have released it.

#### 21.2.1.1. Standard Cache Configurations

The following standard JBoss Cache configurations ship with JBoss Enterprise Application Platform 5. You can add others to suit your needs, or edit these configurations to adjust cache behavior. Additions or changes are done by editing the `deploy/cluster/jboss-cache-manager.sar/META-INF/jboss-cache-manager-jboss-beans.xml` file (see [Section 29.2.1, “Deployment Via the CacheManager Service”](#) for details). Note however that these configurations are specifically optimized for their intended use, and except as specifically noted in the documentation chapters for each service in this guide, it is not advisable to change them.

- **standard-session-cache**  
Standard cache used for web sessions.
- **field-granularity-session-cache**  
Standard cache used for FIELD granularity web sessions.
- **sfsb-cache**  
Standard cache used for EJB3 SFSB caching.
- **ha-partition**

Used by web tier Clustered Single Sign-On, HA-JNDI, Distributed State.

- **mvcc-entity**

A configuration appropriate for JPA/Hibernate entity/collection caching that uses JBoss Cache's MVCC locking (see notes below).

- **optimistic-entity**

A configuration appropriate for JPA/Hibernate entity/collection caching that uses JBoss Cache's optimistic locking (see notes below).

- **pessimistic-entity**

A configuration appropriate for JPA/Hibernate entity/collection caching that uses JBoss Cache's pessimistic locking (see notes below).

- **mvcc-entity-repeatable**

Same as "mvcc-entity" but uses JBoss Cache's REPEATABLE\_READ isolation level instead of READ\_COMMITTED (see notes below).

- **pessimistic-entity-repeatable**

Same as "pessimistic-entity" but uses JBoss Cache's REPEATABLE\_READ isolation level instead of READ\_COMMITTED (see notes below).

- **local-query**

A configuration appropriate for JPA/Hibernate query result caching. Does not replicate query results. DO NOT store the timestamp data Hibernate uses to verify validity of query results in this cache.

- **replicated-query**

A configuration appropriate for JPA/Hibernate query result caching. Replicates query results. DO NOT store the timestamp data Hibernate uses to verify validity of query result in this cache.

- **timestamps-cache**

A configuration appropriate for the timestamp data cached as part of JPA/Hibernate query result caching. A replicated timestamp cache is required if query result caching is used, even if the query results themselves use a non-replicating cache like **local-query**.

- **mvcc-shared**

A configuration appropriate for a cache that's shared for JPA/Hibernate entity, collection, query result and timestamp caching. Not an advised configuration, since it requires cache mode REPL\_SYNC, which is the least efficient mode. Also requires a full state transfer at start up, which can be expensive. Maintained for backwards compatibility reasons, as a shared cache was the only option in JBoss 4. Uses JBoss Cache's MVCC locking.

- **optimistic-shared**

A configuration appropriate for a cache that's shared for JPA/Hibernate entity, collection, query result and timestamp caching. Not an advised configuration, since it requires cache mode REPL\_SYNC, which is the least efficient mode. Also requires a full state transfer at start



up, which can be expensive. Maintained for backwards compatibility reasons, as a shared cache was the only option in JBoss 4. Uses JBoss Cache's optimistic locking.

- **pessimistic-shared**

A configuration appropriate for a cache that's shared for JPA/Hibernate entity, collection, query result and timestamp caching. Not an advised configuration, since it requires cache mode REPL\_SYNC, which is the least efficient mode. Also requires a full state transfer at start up, which can be expensive. Maintained for backwards compatibility reasons, as a shared cache was the only option in JBoss 4. Uses JBoss Cache's pessimistic locking.

- **mvcc-shared-repeatable**

Same as "mvcc-shared" but uses JBoss Cache's REPEATABLE\_READ isolation level instead of READ\_COMMITTED (see notes below).

- **pessimistic-shared-repeatable**

Same as "pessimistic-shared" but uses JBoss Cache's REPEATABLE\_READ isolation level instead of READ\_COMMITTED. (see notes below).



#### NOTE

For more on JBoss Cache's locking schemes, see [Section 29.1.4, “Concurrent Access”](#))



#### NOTE

For JPA/Hibernate second level caching, REPEATABLE\_READ is only useful if the application evicts/clears entities from the EntityManager/Hibernate Session and then expects to repeatedly re-read them in the same transaction. Otherwise, the Session's internal cache provides a repeatable-read semantic.

### 21.2.1.2. Cache Configuration Aliases

The CacheManager also supports aliasing of caches; i.e. allowing caches registered under one name to be looked up under a different name. Aliasing is useful for sharing caches between services whose configuration may specify different cache configuration names. It's also useful for supporting legacy EJB3 application configurations ported over from Enterprise Application Platform 4.

Aliases can be configured by editing the "CacheManager" bean in the `jboss-cache-manager-jboss-beans.xml` file. The following redacted configuration shows the standard aliases in Enterprise Application Platform 5:

```
<bean name="CacheManager" class="org.jboss.ha.cachemanager.CacheManager">
    . . .
    <!-- Aliases for cache names. Allows caches to be shared across
         services that may expect different cache configuration names. -->
    <property name="configAliases">
        <map keyClass="java.lang.String" valueClass="java.lang.String">
            <!-- Use the HAPartition cache for ClusteredSSO caching -->
            <entry>
                <key>clustered-sso</key>
                <value>ha-partition</value>
            </entry>
        </map>
    </property>
</bean>
```

```

    </entry>
    <!-- Handle the legacy name for the EJB3 SFSB cache -->
    <entry>
      <key>jboss.cache:service=EJB3SFSBClusteredCache</key>
      <value>sfsb-cache</value>
    </entry>
    <!-- Handle the legacy name for the EJB3 Entity cache -->
    <entry>
      <key>jboss.cache:service=EJB3EntityTreeCache</key>
      <value>mvcc-shared</value>
    </entry>
  </map>
</property>

. . .

</bean>

```

## 21.3. THE HAPARTITION SERVICE

HAPartition is a general purpose service used for a variety of tasks in Enterprise Application Platform clustering. At its core, it is an abstraction built on top of a JGroups `Channel` that provides support for making/receiving RPC invocations on/from one or more cluster members. HAPartition allows services that use it to share a single `Channel` and multiplex RPC invocations over it, eliminating the configuration complexity and runtime overhead of having each service create its own `Channel`. HAPartition also supports a distributed registry of which clustering services are running on which cluster members. It provides notifications to interested listeners when the cluster membership changes or the clustered service registry changes. HAPartition forms the core of many of the clustering services we will be discussing in the rest of this guide, including smart client-side clustered proxies, EJB 2 SFSB replication and entity cache management, farming, HA-JNDI and HA singletons. Custom services can also make use of HAPartition.

The following snippet shows the `HAPartition` service definition packaged with the standard JBoss Enterprise Application Platform distribution. This configuration can be found in the `server/production/deploy/cluster/hapartition-jboss-beans.xml` file.

```

<bean name="HAPartitionCacheHandler"
class="org.jboss.ha.framework.server.HAPartitionCacheHandlerImpl">
  <property name="cacheManager"><inject bean="CacheManager"/></property>
  <property name="cacheConfigName">ha-partition</property>
</bean>
<bean name="HAPartition"
class="org.jboss.ha.framework.server.ClusterPartition">
  <depends>jboss:service=Naming</depends>
  <annotation>@org.jboss.aop.microcontainer.aspects.jmx.JMX
(name="jboss:service=HAPartition,partition=${jboss.partition.name:DefaultP
artition}",
exposedInterface=org.jboss.ha.framework.server.ClusterPartitionMBean.class
, registerDirectly=true)</annotation>

  <!-- ClusterPartition requires a Cache for state management -->

  <property name="cacheHandler"><inject
bean="HAPartitionCacheHandler"/></property>

```

```

<!-- Name of the partition being built -->

<property
name="partitionName">${jboss.partition.name:DefaultPartition}</property>

<!-- The address used to determine the node name -->

<property name="nodeAddress">${jboss.bind.address}</property>

<!-- Max time (in ms) to wait for state transfer to complete. Increase
for large states -->

<property name="stateTransferTimeout">30000</property>

<!-- Max time (in ms) to wait for RPC calls to complete. -->

<property name="methodCallTimeout">60000</property>

<!-- Optionally provide a thread source to allow async connect of our
channel -->

<property name="threadPool"><inject
bean="jboss.system:service=ThreadPool"/></property>
<property name="distributedStateImpl">
<bean name="DistributedState"
class="org.jboss.ha.framework.server.DistributedStateImpl">

    <annotation>@org.jboss.aop.microcontainer.aspects.jmx.JMX

(name="jboss:service=DistributedState,partitionName=${jboss.partition.name
:DefaultPartition}",
exposedInterface=org.jboss.ha.framework.server.DistributedStateImplBean.c
lass, registerDirectly=true)</annotation>

    <property name="cacheHandler"><inject
bean="HAPartitionCacheHandler"/></property>
</bean>
</property>
</bean>

```

Much of the above is generic; below we will touch on the key points relevant to end users. There are two beans defined above, the `HAPartitionCacheHandler` and the `HAPartition` itself.

The `HAPartition` bean itself exposes the following configuration properties:

- `partitionName` is an optional attribute to specify the name of the cluster. Its default value is `DefaultPartition`. Use the `-g` (a.k.a. `--partition`) command line switch to set this value at server start up.



#### NOTE

If you use the `partitionName` property on the `MBean:ServerConfig Profile` Service component, the system returns a null value for the property. Use the `PartitionName` from the `MBean:HAPartition` managed component to obtain the correct value.

- `nodeAddress` is unused and can be ignored.
- `stateTransferTimeout` specifies the timeout (in milliseconds) for initial application state transfer. State transfer refers to the process of obtaining a serialized copy of initial application state from other already-running cluster members at service start up. Its default value is `30000`.
- `methodCallTimeout` specifies the timeout (in milliseconds) for obtaining responses to group RPCs from the other cluster members. Its default value is `60000`.

The `HAPartitionCacheHandler` is a small utility service that helps the `HAPartition` integrate with JBoss Cache (see [Section 21.2.1, “The JBoss Enterprise Application Platform CacheManager Service”](#) ). `HAPartition` exposes a child service called `DistributedState` (see [Section 21.3.2, “DistributedState Service”](#)) that uses JBoss Cache; the `HAPartitionCacheHandler` helps ensure consistent configuration between the `JGroups Channel` used by `DistributedState`'s cache and the one used directly by `HAPartition`.

- `cacheConfigName` the name of the JBoss Cache configuration to use for the `HAPartition`-related cache. Indirectly, this also specifies the name of the `JGroups` protocol stack configuration `HAPartition` should use. See [Section 29.1.5, “JGroups Integration”](#) for more on how the `JGroups` protocol stack is configured.

In order for nodes to form a cluster, they must have the exact same `partitionName` and the `HAPartitionCacheHandler`'s `cacheConfigName` must specify an identical JBoss Cache configuration. Changes in either element on some but not all nodes would prevent proper clustering behavior.

You can view the current cluster information by pointing your browser to the JMX console of any JBoss instance in the cluster (i.e., `http://hostname:8080/jmx-console/`) and then clicking on the `jboss:service=HAPartition,partition=DefaultPartition` MBean (change the MBean name to reflect your partitioner name if you use the `-g` switch). A list of IP addresses for the current cluster members is shown in the `CurrentView` field.



#### NOTE

While it is technically possible to put a server instance into multiple `HAPartitions` at the same time, this practice is generally not recommended, as it increases management complexity.

### 21.3.1. DistributedReplicantManager Service

The `DistributedReplicantManager` (DRM) service is a component of the `HAPartition` service made available to `HAPartition` users via the `HAPartition.getDistributedReplicantManager()` method. Generally speaking, JBoss Enterprise Application Platform users will not directly make use of the DRM; we discuss it here as an aid to those who want a deeper understanding of how Enterprise Application Platform clustering internals work.

The DRM is a distributed registry that allows `HAPartition` users to register objects under a given key, making available to callers the set of objects registered under that key by the various members of the cluster. The DRM also provides a notification mechanism so interested listeners can be notified when the contents of the registry changes.

There are two main usages for the DRM in JBoss Enterprise Application Platform:

- **Clustered Smart Proxies**

Here the keys are the names of the various services that need a clustered smart proxy (see [Section 20.2.1, “Client-side interceptor architecture”](#), e.g. the name of a clustered EJB. The value object each node stores in the DRM is known as a "target". It's something a smart proxy's transport layer can use to contact the node (e.g. an RMI stub, an HTTP URL or a JBoss Remoting `InvokerLocator`). The factory that builds clustered smart proxies accesses the DRM to get the set of "targets" that should be injected into the proxy to allow it to communicate with all the nodes in a cluster.

- **HASingleton**

Here the keys are the names of the various services that need to function as High Availability Singletons (see the `HASingleton` chapter). The value object each node stores in the DRM is simply a `String` that acts as a token to indicate that the node has the service deployed, and thus is a candidate to become the "master" node for the HA singleton service.

In both cases, the key under which objects are registered identifies a particular clustered service. It is useful to understand that every node in a cluster does not have to register an object under every key. Only services that are deployed on a particular node will register something under that service's key, and services do not have to be deployed homogeneously across the cluster. The DRM is thus useful as a mechanism for understanding a service's "topology" around the cluster – which nodes have the service deployed.

### 21.3.2. DistributedState Service

The `DistributedState` service is a legacy component of the `HAPartition` service made available to `HAPartition` users via the `HAPartition.getDistributedState()` method. This service provides coordinated management of arbitrary application state around the cluster. It is supported for backwards compatibility reasons, but new applications should not use it; they should use the much more sophisticated JBoss Cache instead.

In JBoss Enterprise Application Platform 5 the `DistributedState` service actually delegates to an underlying JBoss Cache instance.

### 21.3.3. Custom Use of HAPartition

Custom services can also use make use of `HAPartition` to handle interactions with the cluster. Generally the easiest way to do this is to extend the

`org.jboss.ha.framework.server.HAServiceImpl` base class, or the `org.jboss.ha.jmx.HAServiceMBeanSupport` class if JMX registration and notification support are desired.

## CHAPTER 22. CLUSTERED JNDI SERVICES

JNDI is one of the most important services provided by the application server. The JBoss HA-JNDI (High Availability JNDI) service brings the following features to JNDI:

- Transparent failover of naming operations. If an HA-JNDI naming Context is connected to the HA-JNDI service on a particular JBoss Enterprise Application Platform instance, and that service fails or is shut down, the HA-JNDI client can transparently fail over to another Enterprise Application Platform instance.
- Load balancing of naming operations. A HA-JNDI naming Context will automatically load balance its requests across all the HA-JNDI servers in the cluster.
- Automatic client discovery of HA-JNDI servers (using multicast).
- Unified view of JNDI trees cluster-wide. A client can connect to the HA-JNDI service running on any node in the cluster and find objects bound in JNDI on any other node. This is accomplished via two mechanisms:
  - Cross-cluster lookups. A client can perform a lookup and the server side HA-JNDI service has the ability to find things bound in regular JNDI on any node in the cluster.
  - A replicated cluster-wide context tree. An object bound into the HA-JNDI service will be replicated around the cluster, and a copy of that object will be available in-VM on each node in the cluster.

JNDI is a key component for many other interceptor-based clustering services: those services register themselves with JNDI so the client can look up their proxies and make use of their services. HA-JNDI completes the picture by ensuring that clients have a highly-available means to look up those proxies. However, it is important to understand that using HA-JNDI (or not) has no effect whatsoever on the clustering behavior of the objects that are looked up. To illustrate:

- If an EJB is not configured as clustered, looking up the EJB via HA-JNDI does not somehow result in the addition of clustering capabilities (load balancing of EJB calls, transparent failover, state replication) to the EJB.
- If an EJB is configured as clustered, looking up the EJB via regular JNDI instead of HA-JNDI does not somehow result in the removal of the bean proxy's clustering capabilities.

### 22.1. HOW IT WORKS

The JBoss client-side HA-JNDI naming Context is based on the client-side interceptor architecture (see the Introduction and Quick Start chapter). The client obtains an HA-JNDI proxy object (via the `InitialContext` object) and invokes JNDI lookup services on the remote server through the proxy. The client specifies that it wants an HA-JNDI proxy by configuring the naming properties used by the `InitialContext` object. This is covered in detail in [Section 22.2, “Client configuration”](#). Other than the need to ensure the appropriate naming properties are provided to the `InitialContext`, the fact that the naming Context is using HA-JNDI is completely transparent to the client.

On the server side, the HA-JNDI service maintains a cluster-wide context tree. The cluster wide tree is always available as long as there is one node left in the cluster. Each node in the cluster also maintains its own local JNDI context tree. The HA-JNDI service on each node is able to find objects bound into the local JNDI context tree, and is also able to make a cluster-wide RPC to find objects bound in the local tree on any other node. An application can bind its objects to either tree, although in practice most objects are bound into the local JNDI context tree. The design rationale for this architecture is as follows:

- It avoids migration issues with applications that assume that their JNDI implementation is local. This allows clustering to work out-of-the-box with just a few tweaks of configuration files.
- In a homogeneous cluster, this configuration actually cuts down on the amount of network traffic. A homogeneous cluster is one where the same types of objects are bound under the same names on each node.
- Designing it in this way makes the HA-JNDI service an optional service since all underlying cluster code uses a straight new `InitialContext` to lookup or create bindings.

On the server side, a naming Context obtained via a call to new `InitialContext()` will be bound to the local-only, non-cluster-wide JNDI Context. So, all EJB homes and such will not be bound to the cluster-wide JNDI Context, but rather, each home will be bound into the local JNDI.

When a remote client does a lookup through HA-JNDI, HA-JNDI will delegate to the local JNDI service when it cannot find the object within the global cluster-wide Context. The detailed lookup rule is as follows.

- If the binding is available in the cluster-wide JNDI tree, return it.
- If the binding is not in the cluster-wide tree, delegate the lookup query to the local JNDI service and return the received answer if available.
- If not available, the HA-JNDI service asks all other nodes in the cluster if their local JNDI service owns such a binding and returns the answer from the set it receives.
- If no local JNDI service owns such a binding, a `NameNotFoundException` is finally raised.

In practice, objects are rarely bound in the cluster-wide JNDI tree; rather they are bound in the local JNDI tree. For example, when EJBs are deployed, their proxies are always bound in local JNDI, not HA-JNDI. So, an EJB home lookup done through HA-JNDI will always be delegated to the local JNDI instance.



#### NOTE

If different beans (even of the same type, but participating in different clusters) use the same JNDI name, this means that each JNDI server will have a logically different "target" bound under the same name (JNDI on node 1 will have a binding for bean A and JNDI on node 2 will have a binding, under the same name, for bean B). Consequently, if a client performs a HA-JNDI query for this name, the query will be invoked on any JNDI server of the cluster and will return the locally bound stub. Nevertheless, it may not be the correct stub that the client is expecting to receive! So, it is always best practice to ensure that across the cluster different names are used for logically different bindings.



#### NOTE

If a binding is only made available on a few nodes in the cluster (for example because a bean is only deployed on a small subset of nodes in the cluster), the probability is higher that a lookup will hit a HA-JNDI server that does not own this binding and thus the lookup will need to be forwarded to all nodes in the cluster. Consequently, the query time will be longer than if the binding would have been available locally. Moral of the story: as much as possible, cache the result of your JNDI queries in your client.

**NOTE**

You cannot currently use a non-JNP JNDI implementation (i.e. LDAP) for your local JNDI implementation if you want to use HA-JNDI. However, you can use JNDI federation using the `ExternalContext` MBean to bind non-JBoss JNDI trees into the JBoss JNDI namespace. Furthermore, nothing prevents you using one centralized JNDI server for your whole cluster and scrapping HA-JNDI and JNP.

## 22.2. CLIENT CONFIGURATION

Configuring a client to use HA-JNDI is a matter of ensuring the correct set of naming environment properties are available when a new `InitialContext` is created. How this is done varies depending on whether the client is running inside JBoss Enterprise Application Platform itself or is in another VM.

### 22.2.1. For clients running inside the Enterprise Application Platform

If you want to access HA-JNDI from inside the Enterprise Application Platform, you must explicitly configure your `InitialContext` by passing in JNDI properties to the constructor. The following code shows how to create a naming Context bound to HA-JNDI:

```
Properties p = new Properties();
p.put(Context.INITIAL_CONTEXT_FACTORY,
"org.jnp.interfaces.NamingContextFactory");
p.put(Context.URL_PKG_PREFIXES, "jboss.naming:org.jnp.interfaces");
// HA-JNDI is listening on the address passed to JBoss via -b
String bindAddress = System.getProperty("jboss.bind.address",
"localhost");
p.put(Context.PROVIDER_URL, bindAddress + ":1100"); // HA-JNDI address and
port.
return new InitialContext(p);
```

The `Context.PROVIDER_URL` property points to the HA-JNDI service configured in the `deploy/cluster/hajndi-jboss-beans.xml` file (see [Section 22.3, “JBoss configuration”](#)). By default this service listens on the interface named via the `jboss.bind.address` system property, which itself is set to whatever value you assign to the `-b` command line option when you start JBoss Enterprise Application Platform (or `localhost` if not specified). The above code shows an example of accessing this property.

However, this does not work in all cases, especially when running several JBoss Enterprise Application Platform instances on the same machine and bound to the same IP address, but configured to use different ports. A safer method is to not specify the `Context.PROVIDER_URL` but instead allow the `InitialContext` to statically find the in-VM HA-JNDI by specifying the `jnp.partitionName` property:

```
Properties p = new Properties();
p.put(Context.INITIAL_CONTEXT_FACTORY,
"org.jnp.interfaces.NamingContextFactory");
p.put(Context.URL_PKG_PREFIXES, "jboss.naming:org.jnp.interfaces");
// HA-JNDI is registered under the partition name passed to JBoss via -g
String partitionName = System.getProperty("jboss.partition.name",
"DefaultPartition");
p.put("jnp.partitionName", partitionName);
return new InitialContext(p);
```



This example uses the `jboss.partition.name` system property to identify the partition with which the HA-JNDI service works. This system property is set to whatever value you assign to the `-g` command line option when you start JBoss Enterprise Application Platform (or `DefaultPartition` if not specified).

Do not attempt to simplify things by placing a `jndi.properties` file in your deployment or by editing the Enterprise Application Platform's `conf/jndi.properties` file. Doing either will almost certainly break things for your application and quite possibly across the server. If you want to externalize your client configuration, one approach is to deploy a properties file not named `jndi.properties`, and then programmatically create a `Properties` object that loads that file's contents.

### 22.2.1.1. Accessing HA-JNDI Resources from EJBs and WARs -- Environment Naming Context

If your HA-JNDI client is an EJB or servlet, the least intrusive way to configure the lookup of resources is to bind the resources to the environment naming context of the bean or webapp performing the lookup. The binding can then be configured to use HA-JNDI instead of a local mapping. Following is an example of doing this for a JMS connection factory and queue (the most common use case for this kind of thing).

Within the bean definition in the `ejb-jar.xml` or in the war's `web.xml` you will need to define two `resource-ref` mappings, one for the connection factory and one for the destination.

```
<resource-ref>
  <res-ref-name>jms/ConnectionFactory</res-ref-name>
  <res-type>javax.jms.QueueConnectionFactory</res-type>
  <res-auth>Container</res-auth>
</resource-ref>

<resource-ref>
  <res-ref-name>jms/Queue</res-ref-name>
  <res-type>javax.jms.Queue</res-type>
  <res-auth>Container</res-auth>
</resource-ref>
```

Using these examples the bean performing the lookup can obtain the connection factory by looking up `'java:comp/env/jms/ConnectionFactory'` and can obtain the queue by looking up `'java:comp/env/jms/Queue'`.

Within the JBoss-specific deployment descriptor (`jboss.xml` for EJBs, `jboss-web.xml` for a WAR) these references need to be mapped to a URL that makes use of HA-JNDI.

```
<resource-ref>
  <res-ref-name>jms/ConnectionFactory</res-ref-name>
  <jndi-name>jnp://${jboss.bind.address}:1100/ConnectionFactory</jndi-name>
</resource-ref>

<resource-ref>
  <res-ref-name>jms/Queue</res-ref-name>
  <jndi-name>jnp://${jboss.bind.address}:1100/queue/A</jndi-name>
</resource-ref>
```

The URL should be the URL to the HA-JNDI server running on the same node as the bean; if the bean is available the local HA-JNDI server should also be available. The lookup will then automatically query all of the nodes in the cluster to identify which node has the JMS resources available.

The `{jboss.bind.address}` syntax used above tells JBoss to use the value of the `jboss.bind.address` system property when determining the URL. That system property is itself set to whatever value you assign to the `-b` command line option when you start JBoss Enterprise Application Platform.

### 22.2.1.2. Why do this programmatically and not just put this in a `jndi.properties` file?

The JBoss Enterprise Application Platform's internal naming environment is controlled by the `conf/jndi.properties` file, which should not be edited.

No other `jndi.properties` file should be deployed inside the Enterprise Application Platform because of the possibility of its being found on the classpath when it should not and thus disrupting the internal operation of the server. For example, if an EJB deployment included a `jndi.properties` configured for HA-JNDI, when the server binds the EJB proxies into JNDI it will likely bind them into the replicated HA-JNDI tree and not into the local JNDI tree where they belong.

### 22.2.1.3. How can I tell if things are being bound into HA-JNDI that should not be?

Go into the `jmx-console` and execute the `list` operation on the `jboss:service=JNDIView` mbean. Towards the bottom of the results, the contents of the "HA-JNDI Namespace" are listed. Typically this will be empty; if any of your own deployments are shown there and you did not explicitly bind them there, there's probably an improper `jndi.properties` file on the classpath. Please visit the following link for an example: [Problem with removing a Node from Cluster](#).

## 22.2.2. For clients running outside the Enterprise Application Platform

The JNDI client needs to be aware of the HA-JNDI cluster. You can pass a list of JNDI servers (i.e., the nodes in the HA-JNDI cluster) to the `java.naming.provider.url` JNDI setting in the `jndi.properties` file. Each server node is identified by its IP address and the JNDI port number. The server nodes are separated by commas (see [Section 22.3, "JBoss configuration"](#) for how to configure the servers and ports).

```
java.naming.provider.url=server1:1100,server2:1100,server3:1100,server4:1100
```

When initializing, the JNP client code will try to get in touch with each server node from the list, one after the other, stopping as soon as one server has been reached. It will then download the HA-JNDI stub from this node.



#### NOTE

There is no load balancing behavior in the JNP client lookup process itself. It just goes through the provider lists and uses the first available server to obtain the stub. The HA-JNDI provider list only needs to contain a subset of HA-JNDI nodes in the cluster; once the HA-JNDI stub is downloaded, the stub will include information on all the available servers. A good practice is to include a set of servers such that you are certain that at least one of those in the list will be available.

The downloaded smart proxy contains the list of currently running nodes and the logic to load balance naming requests and to fail-over to another node if necessary. Furthermore, each time a JNDI invocation is made to the server, the list of targets in the proxy interceptor is updated (only if the list has changed since the last call).

If the property string `java.naming.provider.url` is empty or if all servers it mentions are not

reachable, the JNP client will try to discover a HA-JNDI server through a multicast call on the network (auto-discovery). See [Section 22.3, “JBoss configuration”](#) for how to configure auto-discovery on the JNDI server nodes. Through auto-discovery, the client might be able to get a valid HA-JNDI server node without any configuration. Of course, for auto-discovery to work, the network segment(s) between the client and the server cluster must be configured to propagate such multicast datagrams.

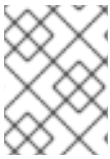

#### NOTE

By default the auto-discovery feature uses multicast group address 230.0.0.4 and port 1102.

In addition to the `java.naming.provider.url` property, you can specify a set of other properties. The following list shows all clustering-related client side properties you can specify when creating a new `InitialContext`. (All of the standard, non-clustering-related environment properties used with regular JNDI are also available.)

- `java.naming.provider.url`: Provides a list of IP addresses and port numbers for HA-JNDI provider nodes in the cluster. The client tries those providers one by one and uses the first one that responds.
- `jnp.disableDiscovery`: When set to `true`, this property disables the automatic discovery feature. Default is `false`.
- `jnp.partitionName`: In an environment where multiple HA-JNDI services bound to distinct clusters (a.k.a. partitions), are running, this property allows you to ensure that your client only accepts automatic-discovery responses from servers in the desired partition. If you do not use the automatic discovery feature (i.e. `jnp.disableDiscovery` is `true`), this property is not used. By default, this property is not set and the automatic discovery selects the first HA-JNDI server that responds, regardless of the cluster partition name.
- `jnp.discoveryTimeout`: Determines how many milliseconds the context will wait for a response to its automatic discovery packet. Default is 5000 ms.
- `jnp.discoveryGroup`: Determines which multicast group address is used for the automatic discovery. Default is 230.0.0.4. Must match the value of the `AutoDiscoveryAddress` configured on the server side HA-JNDI service. Note that the server side HA-JNDI service by default listens on the address specified via the `-u` switch, so if `-u` is used on the server side (as is recommended), `jnp.discoveryGroup` will need to be configured on the client side.
- `jnp.discoveryPort`: Determines which multicast port is used for the automatic discovery. Default is 1102. Must match the value of the `AutoDiscoveryPort` configured on the server side HA-JNDI service.
- `jnp.discoveryTTL`: specifies the TTL (time-to-live) for autodiscovery IP multicast packets. This value represents the number of network hops a multicast packet can be allowed to propagate before networking equipment should drop the packet. Despite its name, it does not represent a unit of time.

## 22.3. JBOSS CONFIGURATION

The `hajndi-jboss-beans.xml` file in the `<JBoss_HOME>/server/production/deploy/cluster` directory includes the following bean to enable HA-JNDI services.

```

<bean name="HAJNDI" class="org.jboss.ha.jndi.HANamingService">

    <annotation>@org.jboss.aop.microcontainer.aspects.jmx.JMX
    (name="jboss:service=HAJNDI",
exposedInterface=org.jboss.ha.jndi.HANamingServiceMBean.class)</annotation
>

    <!-- The partition used for group RPCs to find locally bound objects
on other nodes -->
    <property name="HAPartition"><inject
bean="HAPartition"/></property>

    <!-- Handler for the replicated tree -->
    <property name="distributedTreeManager">
    <bean
class="org.jboss.ha.jndi.impl.jbc.JBossCacheDistributedTreeManager">
    <property name="cacheHandler"><inject
bean="HAPartitionCacheHandler"/></property>
    </bean>
    </property>

    <property name="localNamingInstance">
    <inject bean="jboss:service=NamingBeanImpl"
property="namingInstance"/>
    </property>

    <!-- The thread pool used to control the bootstrap and auto
discovery lookups -->
    <property name="lookupPool"><inject
bean="jboss.system:service=ThreadPool"/></property>

    <!-- Bind address of bootstrap endpoint -->
    <property name="bindAddress">${jboss.bind.address}</property>
    <!-- Port on which the HA-JNDI stub is made available -->
    <property name="port">
    <!-- Get the port from the ServiceBindingManager -->
    <value-factory bean="ServiceBindingManager"
method="getIntBinding">
    <parameter>jboss:service=HAJNDI</parameter>
    <parameter>Port</parameter>
    </value-factory>
    </property>

    <!-- Bind address of the HA-JNDI RMI endpoint -->
    <property name="rmiBindAddress">${jboss.bind.address}</property>

    <!-- RmiPort to be used by the HA-JNDI service once bound. 0 =
ephemeral. -->
    <property name="rmiPort">
    <!-- Get the port from the ServiceBindingManager -->
    <value-factory bean="ServiceBindingManager"
method="getIntBinding">
    <parameter>jboss:service=HAJNDI</parameter>
    <parameter>RmiPort</parameter>
    </value-factory>

```

```

</property>

<!-- Accept backlog of the bootstrap socket -->
<property name="backlog">50</property>

<!-- A flag to disable the auto discovery via multicast -->
<property name="discoveryDisabled">>false</property>
<!-- Set the auto-discovery bootstrap multicast bind address. If not
specified and a BindAddress is specified, the BindAddress will be
used. -->
<property
name="autoDiscoveryBindAddress">${jboss.bind.address}</property>
<!-- Multicast Address and group port used for auto-discovery -->
<property
name="autoDiscoveryAddress">${jboss.partition.udpGroup:230.0.0.4}</propert
y>
<property name="autoDiscoveryGroup">1102</property>
<!-- The TTL (time-to-live) for autodiscovery IP multicast packets -
->
<property name="autoDiscoveryTTL">16</property>

<!-- The load balancing policy for HA-JNDI -->
<property
name="loadBalancePolicy">org.jboss.ha.framework.interfaces.RoundRobin</pro
perty>

<!-- Client socket factory to be used for client-server
RMI invocations during JNDI queries
<property name="clientSocketFactory">custom</property>
-->
<!-- Server socket factory to be used for client-server
RMI invocations during JNDI queries
<property name="serverSocketFactory">custom</property>
-->
</bean>

```

You can see that this bean has a number of other services injected into different properties:

- **HAPartition** accepts the core clustering service used manage HA-JNDI's clustered proxies and to make the group RPCs that find locally bound objects on other nodes. See [Section 21.3, “The HAPartition Service”](#) for more.
- **distributedTreeManager** accepts a handler for the replicated tree. The standard handler uses JBoss Cache to manage the replicated tree. The JBoss Cache instance is retrieved using the injected **HAPartitionCacheHandler** bean. See [Section 21.3, “The HAPartition Service”](#) for more details.
- **localNamingInstance** accepts the reference to the local JNDI service.
- **lookupPool** accepts the thread pool used to provide threads to handle the bootstrap and auto discovery lookups.

Besides the above dependency injected services, the available configuration attributes for the HA-JNDI bean are as follows:

- **bindAddress** specifies the address to which the HA-JNDI server will bind to listen for naming proxy download requests from JNP clients. The default value is the value of the

`jboss.bind.address` system property, or `localhost` if that property is not set. The `jboss.bind.address` system property is set if the `-b` command line switch is used when JBoss is started.

- `port` specifies the port to which the HA-JNDI server will bind to listen for naming proxy download requests from JNP clients. The value is obtained from the `ServiceBindingManager` bean configured in `conf/bootstrap/bindings.xml`. The default value is `1100`.
- `backlog` specifies the maximum queue length for incoming connection indications for the TCP server socket on which the service listens for naming proxy download requests from JNP clients. The default value is `50`.
- `rmiBindAddress` specifies the address to which the HA-JNDI server will bind to listen for RMI requests (e.g. for JNDI lookups) from naming proxies. The default value is the value of the `jboss.bind.address` system property, or `localhost` if that property is not set. The `jboss.bind.address` system property is set if the `-b` command line switch is used when JBoss is started.
- `rmiPort` specifies the port to which the server will bind to communicate with the downloaded stub. The value is obtained from the `ServiceBindingManager` bean configured in `conf/bootstrap/bindings.xml`. The default value is `1101`. If no value is set, the operating system automatically assigns a port.
- `discoveryDisabled` is a boolean flag that disables configuration of the auto discovery multicast listener. The default is `false`.
- `autoDiscoveryAddress` specifies the multicast address to listen to for JNDI automatic discovery. The default value is the value of the `jboss.partition.udpGroup` system property, or `230.0.0.4` if that is not set. The `jboss.partition.udpGroup` system property is set if the `-u` command line switch is used when JBoss is started.
- `autoDiscoveryGroup` specifies the port to listen on for multicast JNDI automatic discovery packets. The default value is `1102`.
- `autoDiscoveryBindAddress` sets the interface on which HA-JNDI should listen for auto-discovery request packets. If this attribute is not specified and a `bindAddress` is specified, the `bindAddress` will be used.
- `autoDiscoveryTTL` specifies the TTL (time-to-live) for autodiscovery IP multicast packets. This value represents the number of network hops a multicast packet can be allowed to propagate before networking equipment should drop the packet. Despite its name, it does not represent a unit of time.
- `loadBalancePolicy` specifies the class name of the `LoadBalancePolicy` implementation that should be included in the client proxy. See [Chapter 19, Introduction and Quick Start](#) the Introduction and Quick Start chapter for details.
- `clientSocketFactory` is an optional attribute that specifies the fully qualified classname of the `java.rmi.server.RMIClientSocketFactory` that should be used to create client sockets. The default is `null`.
- `serverSocketFactory` is an optional attribute that specifies the fully qualified classname of the `java.rmi.server.RMIServerSocketFactory` that should be used to create server sockets. The default is `null`.

### 22.3.1. Adding a Second HA-JNDI Service

It is possible to start several HA-JNDI services that use different HAPartitions. This can be used, for example, if a node is part of many logical clusters. In this case, make sure that you set a different port or IP address for each service. For instance, if you wanted to hook up HA-JNDI to the example cluster you set up and change the binding port, the bean descriptor would look as follows (properties that do not vary from the standard deployments are omitted):

```

<!-- Cache Handler for secondary HAPartition -->
<bean name="SecondaryHAPartitionCacheHandler"
class="org.jboss.ha.framework.server.HAPartitionCacheHandlerImpl">
  <property name="cacheManager"><inject
bean="CacheManager"/></property>
  <property name="cacheConfigName">secondary-ha-
partition</property>
</bean>

<!-- The secondary HAPartition -->
<bean name="SecondaryHAPartition"
class="org.jboss.ha.framework.server.ClusterPartition">

  <depends>jboss:service=Naming</depends>

  <annotation>@org.jboss.aop.microcontainer.aspects.jmx.JMX
(name="jboss:service=HAPartition,partition=SecondaryPartition",
exposedInterface=org.jboss.ha.framework.server.ClusterPartitionMBean.class
, registerDirectly=true)</annotation>

  <property name="cacheHandler"><inject
bean="SecondaryHAPartitionCacheHandler"/></property>

  <property name="partitionName">SecondaryPartition</property>

  ....
</bean>

<bean name="MySpecialPartitionHAJNDI"
class="org.jboss.ha.jndi.HANamingService">

  <annotation>@org.jboss.aop.microcontainer.aspects.jmx.JMX
(name="jboss:service=HAJNDI,partitionName=SecondaryPartition",
exposedInterface=org.jboss.ha.jndi.HANamingServiceMBean.class)</annotation
>

  <property name="HAPartition"><inject
bean="SecondaryHAPartition"/></property>

  <property name="distributedTreeManager">
  <bean
class="org.jboss.ha.jndi.impl.jbc.JBossCacheDistributedTreeManager">
    <property name="cacheHandler"><inject
bean="SecondaryHAPartitionPartitionCacheHandler"/></property>
  </bean>

```

```
</property>  
  
<property name="port">56789</property>  
  
<property name="rmiPort">56790</property>  
  
<property name="autoDiscoveryGroup">56791</property>  
  
.....  
</bean>
```



## CHAPTER 23. CLUSTERED SESSION EJBS

Session EJBS provide remote invocation services. They are clustered based on the client-side interceptor architecture. The client application for a clustered session bean is the same as the client for the non-clustered version of the session bean, except for some minor changes. No code change or re-compilation is needed on the client side. Now, let us check out how to configure clustered session beans in EJB 3.0 and EJB 2.x server applications respectively.

### 23.1. STATELESS SESSION BEAN IN EJB 3.0

Clustering stateless session beans is probably the easiest case since no state is involved. Calls can be load balanced to any participating node (i.e. any node that has this specific bean deployed) of the cluster.

To cluster a stateless session bean in EJB 3.0, simply annotate the bean class with the `@Clustered` annotation. This annotation contains optional parameters for overriding both the load balance policy and partition to use.

```
public @interface Clustered
{
    String partition() default "${jboss.partition.name:DefaultPartition}";
    String loadBalancePolicy() default "LoadBalancePolicy";
}
```

- **partition** specifies the name of the cluster the bean participates in. While the `@Clustered` annotation lets you override the default partition, `DefaultPartition`, for an individual bean, you can override this for all beans using the `jboss.partition.name` system property.
- **loadBalancePolicy** defines the name of a class implementing `org.jboss.ha.client.loadbalance.LoadBalancePolicy`, indicating how the bean stub should balance calls made on the nodes of the cluster. The default value, `LoadBalancePolicy` is a special token indicating the default policy for the session bean type. For stateless session beans, the default policy is `org.jboss.ha.client.loadbalance.RoundRobin`. You can override the default value using your own implementation, or choose one from the list of available policies:

#### `org.jboss.ha.client.loadbalance.RoundRobin`

Starting with a random target, always favors the next available target in the list, ensuring maximum load balancing always occurs.

#### `org.jboss.ha.client.loadbalance.RandomRobin`

Randomly selects its target without any consideration to previously selected targets.

#### `org.jboss.ha.client.loadbalance.aop.FirstAvailable`

Once a target is chosen, always favors that same target; i.e. no further load balancing occurs. Useful in cases where "sticky session" behavior is desired, e.g. stateful session beans.

#### `org.jboss.ha.client.loadbalance.aop.FirstAvailableIdenticalAllProxies`

Similar to `FirstAvailable`, except that the favored target is shared across all proxies.

Here is an example of a clustered EJB 3.0 stateless session bean implementation.

```
@Stateless
@Clustered
public class MyBean implements MySessionInt
{
    public void test()
    {
        // Do something cool
    }
}
```

Rather than using the `@Clustered` annotation, you can also enable clustering for a session bean in `jboss.xml`:

```
<jboss>
  <enterprise-beans>
    <session>
      <ejb-name>NonAnnotationStateful</ejb-name>
      <clustered>true</clustered>
      <cluster-config>
        <partition-name>FooPartition</partition-name>
        <load-balance-
policy>org.jboss.ha.framework.interfaces.RandomRobin</load-balance-policy>
      </cluster-config>
    </session>
  </enterprise-beans>
</jboss>
```



#### NOTE

The `<clustered>true</clustered>` element is really just an alias for the `<container-name>Clustered Stateless SessionBean</container-name>` element in the `conf/standardjboss.xml` file.

In the bean configuration, only the `<clustered>` element is necessary to indicate that the bean needs to support clustering features. The default values for the optional `<cluster-config>` elements match those of the corresponding properties from the `@Clustered` annotation.

## 23.2. STATEFUL SESSION BEANS IN EJB 3.0

Clustering stateful session beans is more complex than clustering their stateless counterparts since JBoss needs to manage the state information. The state of all stateful session beans are replicated and synchronized across the cluster each time the state of a bean changes.

### 23.2.1. The EJB application configuration

To cluster stateful session beans in EJB 3.0, you need to tag the bean implementation class with the `@Clustered` annotation, just as we did with the EJB 3.0 stateless session bean earlier. In contrast to stateless session beans, stateful session bean method invocations are load balanced using `org.jboss.ha.client.loadbalance.aop.FirstAvailable` policy, by default. Using this policy, methods invocations will stick to a randomly chosen node.

The `@org.jboss.ejb3.annotation.CacheConfig` annotation can also be applied to the bean to override the default caching behavior. Below is the definition of the `@CacheConfig` annotation:

```
public @interface CacheConfig
{
    String name() default "";
    int maxSize() default 10000;
    long idleTimeoutSeconds() default 300;
    boolean replicationIsPassivation() default true;
    long removalTimeoutSeconds() default 0;
}
```

- **name** specifies the name of a cache configuration registered with the `CacheManager` service discussed in [Section 23.2.3, “CacheManager service configuration”](#). By default, the `sfsb-cache` configuration will be used.
- **maxSize** specifies the maximum number of beans that can be cached before the cache should start passivating beans, using an LRU algorithm.
- **idleTimeoutSeconds** specifies the max period of time a bean can go unused before the cache should passivate it (regardless of whether `maxSize` beans are cached.)
- **removalTimeoutSeconds** specifies the max period of time a bean can go unused before the cache should remove it altogether.
- **replicationIsPassivation** specifies whether the cache should consider a replication as being equivalent to a passivation, and invoke any `@PrePassivate` and `@PostActivate` callbacks on the bean. By default `true`, since replication involves serializing the bean, and preparing for and recovering from serialization is a common reason for implementing the callback methods.

Here is an example of a clustered EJB 3.0 stateful session bean implementation.

```
@Stateful
@Clustered
@CacheConfig(maxSize=5000, removalTimeoutSeconds=18000)
public class MyBean implements MySessionInt
{
    private int state = 0;

    public void increment()
    {
        System.out.println("counter: " + (state++));
    }
}
```

As with stateless beans, the `@Clustered` annotation can alternatively be omitted and the clustering configuration instead applied to `jboss.xml`:

```
<jboss>
  <enterprise-beans>
    <session>
      <ejb-name>NonAnnotationStateful</ejb-name>
      <clustered>true</clustered>
      <cache-config>
        <cache-max-size>5000</cache-max-size>
```

```

        <remove-timeout-seconds>18000</remove-timeout-seconds>
    </cache-config>
</session>
</enterprise-beans>
</jboss>

```

### 23.2.2. Optimize state replication

As the replication process is a costly operation, you can optimize this behavior by optionally implementing the `org.jboss.ejb3.cache.Optimized` interface in your bean class:

```

public interface Optimized
{
    boolean isModified();
}

```

Before replicating your bean, the container will check if your bean implements the **Optimized** interface. If this is the case, the container calls the `isModified()` method and will only replicate the bean when the method returns `true`. If the bean has not been modified (or not enough to require replication, depending on your own preferences), you can return `false` and the replication would not occur.

### 23.2.3. CacheManager service configuration

JBoss Cache provides the session state replication service for EJB 3.0 stateful session beans. The **CacheManager** service, described in [Section 21.2.1, “The JBoss Enterprise Application Platform CacheManager Service”](#) is both a factory and registry of JBoss Cache instances. By default, stateful session beans use the `sfsb-cache` configuration from the **CacheManager**, defined as follows:

```

<bean name="StandardSFSBCacheConfig"
class="org.jboss.cache.config.Configuration">

    <!-- No transaction manager lookup -->

    <!-- Name of cluster. Needs to be the same for all members -->
    <property name="clusterName">${jboss.partition.name:DefaultPartition}-
SFSBCache</property>
    <!--
        Use a UDP (multicast) based stack. Need JGroups flow control (FC)
        because we are using asynchronous replication.
    -->
    <property
name="multiplexerStack">${jboss.default.jgroups.stack:udp}</property>
    <property name="fetchInMemoryState">true</property>

    <property name="nodeLockingScheme">PESSIMISTIC</property>
    <property name="isolationLevel">REPEATABLE_READ</property>
    <property name="useLockStriping">false</property>
    <property name="cacheMode">REPL_ASYNC</property>

    <!--
        Number of milliseconds to wait until all responses for a
        synchronous call have been received. Make this longer
        than lockAcquisitionTimeout.
    -->

```

```

-->
<property name="syncReplTimeout">17500</property>
<!-- Max number of milliseconds to wait for a lock acquisition -->
<property name="lockAcquisitionTimeout">15000</property>
<!-- The max amount of time (in milliseconds) we wait until the
state (ie. the contents of the cache) are retrieved from
existing members at startup. -->
<property name="stateRetrievalTimeout">60000</property>

<!--
  SFSBs use region-based marshalling to provide for partial state
  transfer during deployment/undeployment.
-->
<property name="useRegionBasedMarshalling">>false</property>
<!-- Must match the value of "useRegionBasedMarshalling" -->
<property name="inactiveOnStartup">>false</property>

<!-- Disable asynchronous RPC marshalling/sending -->
<property name="serializationExecutorPoolSize">0</property>
<!-- We have no asynchronous notification listeners -->
<property name="listenerAsyncPoolSize">0</property>

<property name="exposeManagementStatistics">>true</property>

<property name="buddyReplicationConfig">
  <bean class="org.jboss.cache.config.BuddyReplicationConfig">

    <!-- Just set to true to turn on buddy replication -->
    <property name="enabled">>false</property>

    <!--
      A way to specify a preferred replication group. We try
      and pick a buddy who shares the same pool name (falling
      back to other buddies if not available).
    -->
    <property name="buddyPoolName">default</property>

    <property name="buddyCommunicationTimeout">17500</property>

    <!-- Do not change these -->
    <property name="autoDataGravitation">>false</property>
    <property name="dataGravitationRemoveOnFind">>true</property>
    <property name="dataGravitationSearchBackupTrees">>true</property>

    <property name="buddyLocatorConfig">
      <bean
class="org.jboss.cache.buddyreplication.NextMemberBuddyLocatorConfig">
        <!-- The number of backup nodes we maintain -->
        <property name="numBuddies">1</property>
        <!-- Means that each node will *try* to select a buddy on
a different physical host. If not able to do so
though, it will fall back to colocated nodes. -->
        <property name="ignoreColocatedBuddies">>true</property>
      </bean>
    </property>
  </bean>
</property>
</bean>

```

```

</property>
<property name="cacheLoaderConfig">
  <bean class="org.jboss.cache.config.CacheLoaderConfig">
    <!-- Do not change these -->
    <property name="passivation">true</property>
    <property name="shared">>false</property>

    <property name="individualCacheLoaderConfigs">
      <list>
        <bean class="org.jboss.cache.loader.FileCacheLoaderConfig">
          <!-- Where passivated sessions are stored -->
          <property
name="location">${jboss.server.data.dir}${/}sfsb</property>
          <!-- Do not change these -->
          <property name="async">>false</property>
          <property name="fetchPersistentState">true</property>
          <property name="purgeOnStartup">true</property>
          <property name="ignoreModifications">>false</property>
          <property name="checkCharacterPortability">>false</property>
        </bean>
      </list>
    </property>
  </bean>
</property>

<!-- EJBs use JBoss Cache eviction -->
<property name="evictionConfig">
  <bean class="org.jboss.cache.config.EvictionConfig">
    <property name="wakeupInterval">5000</property>
    <!-- Overall default -->
    <property name="defaultEvictionRegionConfig">
      <bean class="org.jboss.cache.config.EvictionRegionConfig">
        <property name="regionName">/</property>
        <property name="evictionAlgorithmConfig">
          <bean
class="org.jboss.cache.eviction.NullEvictionAlgorithmConfig"/>
        </property>
      </bean>
    </property>
    <!-- EJB3 integration code will programatically create other regions
as beans are deployed -->
  </bean>
</property>
</bean>

```

## Eviction

The default SFSB cache is configured to support eviction. The EJB3 SFSB container uses the JBoss Cache eviction mechanism to manage SFSB passivation. When beans are deployed, the EJB container will programatically add eviction regions to the cache, one region per bean type.

## CacheLoader

A JBoss Cache CacheLoader is also configured; again to support SFSB passivation. When beans are evicted from the cache, the cache loader passivates them to a persistent store; in this case to the file system in the `<JBOSS_HOME>/server/production/data/sfsb` directory. JBoss Cache supports a variety of different CacheLoader implementations that know how to store data to different persistent

store types; see the JBoss Cache documentation for details. However, if you change the `CacheLoaderConfiguration`, be sure that you do not use a shared store, e.g. a single schema in a shared database. Each node in the cluster must have its own persistent store, otherwise as nodes independently passivate and activate clustered beans, they will corrupt each other's data.

### Buddy Replication

Using buddy replication, state is replicated to a configurable number of backup servers in the cluster (a.k.a. buddies), rather than to all servers in the cluster. To enable buddy replication, adjust the following properties in the `buddyReplicationConfig` property bean:

- Set `enabled` to `true`.
- Use the `buddyPoolName` to form logical subgroups of nodes within the cluster. If possible, buddies will be chosen from nodes in the same buddy pool.
- Adjust the `buddyLocatorConfig.numBuddies` property to reflect the number of backup nodes to which each node should replicate its state.

## 23.3. STATELESS SESSION BEAN IN EJB 2.X

To make an EJB 2.x bean clustered, you need to modify its `jboss.xml` descriptor to contain a `<clustered>` tag.

```
<jboss>
  <enterprise-beans>
    <session>
      <ejb-name>nextgen.StatelessSession</ejb-name>
      <jndi-name>nextgen.StatelessSession</jndi-name>
      <clustered>true</clustered>
      <cluster-config>
        <partition-name>DefaultPartition</partition-name>
        <home-load-balance-
policy>org.jboss.ha.framework.interfaces.RoundRobin</home-load-balance-
policy>
        <bean-load-balance-
policy>org.jboss.ha.framework.interfaces.RoundRobin</bean-load-balance-
policy>
      </cluster-config>
    </session>
  </enterprise-beans>
</jboss>
```

- `partition-name` specifies the name of the cluster the bean participates in. The default value is `DefaultPartition`. The default partition name can also be set system-wide using the `jboss.partition.name` system property.
- `home-load-balance-policy` indicates the class to be used by the home stub to balance calls made on the nodes of the cluster. By default, the proxy will load-balance calls in a `RoundRobin` fashion.
- `bean-load-balance-policy` Indicates the class to be used by the bean stub to balance calls made on the nodes of the cluster. By default, the proxy will load-balance calls in a `RoundRobin` fashion.

## 23.4. STATEFUL SESSION BEAN IN EJB 2.X

Clustering stateful session beans is more complex than clustering their stateless counterparts since JBoss needs to manage the state information. The state of all stateful session beans are replicated and synchronized across the cluster each time the state of a bean changes. The JBoss Enterprise Application Platform uses the `HASessionStateService` bean to manage distributed session states for clustered EJB 2.x stateful session beans. In this section, we cover both the session bean configuration and the `HASessionStateService` bean configuration.

### 23.4.1. The EJB application configuration

In the EJB application, you need to modify the `jboss.xml` descriptor file for each stateful session bean and add the `<clustered>` tag.

```
<jboss>
  <enterprise-beans>
    <session>
      <ejb-name>nextgen.StatefulSession</ejb-name>
      <jndi-name>nextgen.StatefulSession</jndi-name>
      <clustered>True</clustered>
      <cluster-config>
        <partition-name>DefaultPartition</partition-name>
        <home-load-balance-
policy>org.jboss.ha.framework.interfaces.RoundRobin</home-load-balance-
policy>
        <bean-load-balance-
policy>org.jboss.ha.framework.interfaces.FirstAvailable</bean-load-
balance-policy>
        <session-state-manager-jndi-name>/HASessionState/Default</session-
state-manager-jndi-name>
      </cluster-config>
    </session>
  </enterprise-beans>
</jboss>
```

In the bean configuration, only the `<clustered>` tag is mandatory to indicate that the bean works in a cluster. The `<cluster-config>` element is optional and its default attribute values are indicated in the sample configuration above.

The `<session-state-manager-jndi-name>` tag is used to give the JNDI name of the `HASessionStateService` to be used by this bean.

The description of the remaining tags is identical to the one for stateless session bean. Actions on the clustered stateful session bean's home interface are by default load-balanced, round-robin. Once the bean's remote stub is available to the client, calls will not be load-balanced round-robin any more and will stay "sticky" to the first node in the list.

### 23.4.2. Optimize state replication

As the replication process is a costly operation, you can optimize this behavior by optionally implementing in your bean class a method with the following signature:

```
public boolean isModified();
```



Before replicating your bean, the container will detect if your bean implements this method. If your bean does, the container calls the `isModified()` method and it only replicates the bean when the method returns `true`. If the bean has not been modified (or not enough to require replication, depending on your own preferences), you can return `false` and the replication would not occur.

### 23.4.3. The `HASessionStateService` configuration

The `HASessionStateService` bean is defined in the `<JBoss_HOME>/server/<PROFILE>/deploy/cluster/ha-legacy-jboss-beans.xml` file.

```
<bean name="HASessionStateService"
      class="org.jboss.ha.hasessionstate.server.HASessionStateService">

  <annotation>@org.jboss.aop.microcontainer.aspects.jmx.JMX
  (name="jboss:service=HASessionState",
  exposedInterface=org.jboss.ha.hasessionstate.server.
  HASessionStateServiceMBean.class,
  registerDirectly=true)</annotation>

  <!-- Partition used for group RPCs -->
  <property name="HAPartition"><inject bean="HAPartition"/></property>

  <!-- JNDI name under which the service is bound -->
  <property name="jndiName">/HASessionState/Default</property>
  <!-- Max delay before cleaning unreclaimed state.
  Defaults to 30*60*1000 => 30 minutes -->
  <property name="beanCleaningDelay">0</property>

</bean>
```

The configuration attributes in the `HASessionStateService` bean are listed below.

- **HAPartition** is a required attribute to inject the `HAPartition` service that HA-JNDI uses for intra-cluster communication.
- **jndiName** is an optional attribute to specify the JNDI name under which this `HASessionStateService` bean is bound. The default value is `/HAPartition/Default`.
- **beanCleaningDelay** is an optional attribute to specify the number of milliseconds after which the `HASessionStateService` can clean a state that has not been modified. If a node, owning a bean, crashes, its brother node will take ownership of this bean. Nevertheless, the container cache of the brother node will not know about it (because it has never seen it before) and will never delete according to the cleaning settings of the bean. That is why the `HASessionStateService` needs to do this cleanup sometimes. The default value is `30*60*1000` milliseconds (i.e., 30 minutes).

### 23.4.4. Handling Cluster Restart

We have covered the HA smart client architecture in [Section 20.2.1, “Client-side interceptor architecture”](#). The default HA smart proxy client can only failover as long as one node in the cluster exists. If there is a complete cluster shutdown, the proxy becomes orphaned and loses knowledge of the available nodes in the cluster. There is no way for the proxy to recover from this. The proxy needs to look up a fresh set of targets out of JNDI/HA-JNDI when the nodes are restarted.

RetryInterceptor can be added to the proxy client side interceptor stack to allow for a transparent recovery from such a restart failure. To enable it for an EJB, setup an invoker-proxy-binding that includes the RetryInterceptor. Below is an example jboss.xml configuration.

```
<jboss>
  <session>
    <ejb-name>nextgen_RetryInterceptorStatelessSession</ejb-name>
    <invoker-bindings>
      <invoker>
        <invoker-proxy-binding-name>clustered-retry-stateless-rmi-
invoker</invoker-proxy-binding-name>
        <jndi-name>nextgen_RetryInterceptorStatelessSession</jndi-name>
      </invoker>
    </invoker-bindings>
    <clustered>true</clustered>
  </session>
  <invoker-proxy-binding>
    <name>clustered-retry-stateless-rmi-invoker</name>
    <invoker-mbean>jboss:service=invoker,type=jrmpha</invoker-mbean>
    <proxy-factory>org.jboss.proxy.ejb.ProxyFactoryHA</proxy-factory>
    <proxy-factory-config>
      <client-interceptors>
        <home>
          <interceptor>org.jboss.proxy.ejb.HomeInterceptor</interceptor>
          <interceptor>org.jboss.proxy.SecurityInterceptor</interceptor>

<interceptor>org.jboss.proxy.TransactionInterceptor</interceptor>
          <interceptor>org.jboss.proxy.ejb.RetryInterceptor</interceptor>

<interceptor>org.jboss.invocation.InvokerInterceptor</interceptor>
          </home>
          <bean>

<interceptor>org.jboss.proxy.ejb.StatelessSessionInterceptor</interceptor>
          <interceptor>org.jboss.proxy.SecurityInterceptor</interceptor>

<interceptor>org.jboss.proxy.TransactionInterceptor</interceptor>
          <interceptor>org.jboss.proxy.ejb.RetryInterceptor</interceptor>

<interceptor>org.jboss.invocation.InvokerInterceptor</interceptor>
          </bean>
        </client-interceptors>
      </proxy-factory-config>
    </invoker-proxy-binding>
  </jboss>
```

### 23.4.5. JNDI Lookup Process

In order to recover the HA proxy, the RetryInterceptor does a lookup in JNDI. This means that internally it creates a new InitialContext and does a JNDI lookup. But, for that lookup to succeed, the InitialContext needs to be configured properly to find your naming server. The RetryInterceptor will go through the following steps in attempting to determine the proper naming environment properties:

1. It will check its own static retryEnv field. This field can be set by client code via a call to

`RetryInterceptor.setRetryEnv(Properties)`. This approach to configuration has two downsides: first, it reduces portability by introducing JBoss-specific calls to the client code; and second, since a static field is used only a single configuration per VM is possible.

2. If the `retryEnv` field is null, it will check for any environment properties bound to a `ThreadLocal` by the `org.jboss.naming.NamingContextFactory` class. To use this class as your naming context factory, in your `jni.properties` set property `java.naming.factory.initial=org.jboss.naming.NamingContextFactory`. The advantage of this approach is use of `org.jboss.naming.NamingContextFactory` is simply a configuration option in your `jni.properties` file, and thus your java code is unaffected. The downside is the naming properties are stored in a `ThreadLocal` and thus are only visible to the thread that originally created an `InitialContext`.
3. If neither of the above approaches yield a set of naming environment properties, a default `InitialContext` is used. If the attempt to contact a naming server is unsuccessful, by default the `InitialContext` will attempt to fall back on multicast discovery to find an HA-JNDI naming server. See [Chapter 22, \*Clustered JNDI Services\*](#) for more on multicast discovery of HA-JNDI.

### 23.4.6. `SingleRetryInterceptor`

The `RetryInterceptor` is useful in many use cases, but a disadvantage it has is that it will continue attempting to re-lookup the HA proxy in JNDI until it succeeds. If for some reason it cannot succeed, this process could go on forever, and thus the EJB call that triggered the `RetryInterceptor` will never return. For many client applications, this possibility is unacceptable. As a result, JBoss does not make the `RetryInterceptor` part of its default client interceptor stacks for clustered EJBs.

In a previous release, a new flavor of retry interceptor was introduced, the `org.jboss.proxy.ejb.SingleRetryInterceptor`. This version works like the `RetryInterceptor`, but only makes a single attempt to re-lookup the HA proxy in JNDI. If this attempt fails, the EJB call will fail just as if no retry interceptor was used. The `SingleRetryInterceptor` is now part of the default client interceptor stacks for clustered EJBs.

The downside of the `SingleRetryInterceptor` is that if the retry attempt is made during a portion of a cluster restart where no servers are available, the retry will fail and no further attempts will be made.

## CHAPTER 24. CLUSTERED ENTITY EJBS

In a JBoss Enterprise Application Platform cluster, entity bean instance caches need to be kept in sync across all nodes. If an entity bean provides remote services, the service methods need to be load balanced as well.

### 24.1. ENTITY BEAN IN EJB 3.0

In EJB 3.0, entity beans primarily serve as a persistence data model. They do not provide remote services. Hence, the entity bean clustering service in EJB 3.0 primarily deals with distributed caching and replication, instead of load balancing.

#### 24.1.1. Configure the distributed cache

To avoid round trips to the database, you can use a cache for your entities. JBoss EJB 3.0 entity beans are implemented by Hibernate, which has support for a second-level cache. The second-level cache provides the following functionalities:

- If you persist a cache-enabled entity bean instance to the database via the entity manager, the entity will be inserted into the cache.
- If you update an entity bean instance, and save the changes to the database via the entity manager, the entity will be updated in the cache.
- If you remove an entity bean instance from the database via the entity manager, the entity will be removed from the cache.
- If loading a cached entity from the database via the entity manager, and that entity does not exist in the database, it will be inserted into the cache.

As well as a region for caching entities, the second-level cache also contains regions for caching collections, queries, and timestamps. The Hibernate setup used for the JBoss EJB 3.0 implementation uses JBoss Cache as its underlying second-level cache implementation.

Configuration of a the second-level cache is done via your EJB3 deployment's `persistence.xml`, like so:

```
<?xml version="1.0" encoding="UTF-8"?>
<persistence xmlns:xsi="http://www.w3.org/2001/XMLSchema-instance"
xmlns="http://java.sun.com/xml/ns/persistence"
xsi:schemaLocation="http://java.sun.com/xml/ns/persistence
http://java.sun.com/xml/ns/persistence/persistence_1_0.xsd">
  <persistence-unit name="tempdb" transaction-type="JTA">
    <jta-data-source>java:/DefaultDS</jta-data-source>
    <properties>
      <property name="hibernate.cache.use_second_level_cache"
value="true"/>
      <property name="hibernate.cache.use_query_cache" value="true"/>
      <property name="hibernate.cache.region.factory_class"
value="org.hibernate.cache.jbc2.JndiMultiplexedJBossCacheRegionFactory"/>
      <!-- region factory specific properties -->
      <property name="hibernate.cache.region.jbc2.cachefactory"
value="java:CacheManager"/>
      <property name="hibernate.cache.region.jbc2.cfg.entity" value="mvcc-
entity"/>
    </properties>
  </persistence-unit>
</persistence>
```

```

        <property name="hibernate.cache.region.jbc2.cfg.collection"
value="mvcc-entity"/>
    </properties>
</persistence-unit>
</persistence>

```

#### **hibernate.cache.use\_second\_level\_cache**

Enables second-level caching of entities and collections.

#### **hibernate.cache.use\_query\_cache**

Enables second-level caching of queries.

#### **hibernate.cache.region.factory\_class**

Defines the **RegionFactory** implementation that dictates region-specific caching behavior. Hibernate ships with 2 types of JBoss Cache-based second-level caches: shared and multiplexed.

A shared region factory uses the same Cache for all cache regions - much like the legacy CacheProvider implementation in older Hibernate versions.

Hibernate ships with 2 shared region factory implementations:

#### **org.hibernate.cache.jbc2.SharedJBossCacheRegionFactory**

Uses a single JBoss Cache configuration, from a newly instantiated CacheManager, for all cache regions.

**Table 24.1. Additional properties for SharedJBossCacheRegionFactory**

Property	Default	Description
hibernate.cache.region.jbc2.cfg.shared	treecache.xml	The classpath or file system resource containing the JBoss Cache configuration settings.
hibernate.cache.region.jbc2.cfg.jgroups.stacks	org/hibernate/cache/jbc2/builder/jgroups-stacks.xml	The classpath or file system resource containing the JGroups protocol stack configurations.

#### **org.hibernate.cache.jbc2.JndiSharedJBossCacheRegionFactory**

Uses a single JBoss Cache configuration, from an existing CacheManager bound to JNDI, for all cache regions.

**Table 24.2. Additional properties for JndiSharedJBossCacheRegionFactory**

Property	Default	Description
hibernate.cache.region.jbc2.cfg.shared	<i>Required</i>	JNDI name to which the shared <b>Cache</b> instance is bound.

A multiplexed region factory uses separate Cache instances, using optimized configurations for each cache region.

**Table 24.3. Common properties for multiplexed region factory implementations**

Property	Default	Description
hibernate.cache.region.jbc2.cfg.entity	optimistic-entity	The JBoss Cache configuration used for the entity cache region. Alternative configurations: mvcc-entity, pessimistic-entity, mvcc-entity-repeatable, optimistic-entity-repeatable, pessimistic-entity-repeatable
hibernate.cache.region.jbc2.cfg.collection	optimistic-entity	The JBoss Cache configuration used for the collection cache region. The collection cache region typically uses the same configuration as the entity cache region.
hibernate.cache.region.jbc2.cfg.query	local-query	The JBoss Cache configuration used for the query cache region. By default, cached query results are not replicated. Alternative configurations: replicated-query
hibernate.cache.region.jbc2.cfg.ts	timestamps-cache	The JBoss Cache configuration used for the timestamp cache region. If query caching is used, the corresponding timestamp cache must be replicating, even if the query cache is non-replicating. The timestamp cache region must never share the same cache as the query cache.

Hibernate ships with 2 shared region factory implementations:

#### **org.hibernate.cache.jbc2.MultiplexedJBossCacheRegionFactory**

Uses separate JBoss Cache configurations, from a newly instantiated CacheManager, per cache region.

**Table 24.4. Additional properties for MultiplexedJBossCacheRegionFactory**

Property	Default	Description
hibernate.cache.region.jbc2.configs	org/hibernate/cache/jbc2/builder/jbc2-configs.xml	The classpath or file system resource containing the JBoss Cache configuration settings.

Property	Default	Description
hibernate.cache.region.jbc2.cf g.jgroups.stacks	org/hibernate/cache/jbc2/buil der/jgroups-stacks.xml	The classpath or file system resource containing the JGroups protocol stack configurations.

### org.hibernate.cache.jbc2.JndiMultiplexedJBossCacheRegionFactory

Uses separate JBoss Cache configurations, from a JNDI-bound CacheManager, see [Section 21.2.1, “The JBoss Enterprise Application Platform CacheManager Service”](#), per cache region.

**Table 24.5. Additional properties for JndiMultiplexedJBossCacheRegionFactory**

Property	Default	Description
hibernate.cache.region.jbc2.ca chefactory	<i>Required</i>	JNDI name to which the <b>CacheManager</b> instance is bound.

Now, we have JBoss Cache configured to support distributed caching of EJB 3.0 entity beans. We still have to configure individual entity beans to use the cache service.

### 24.1.2. Configure the entity beans for cache

Next we need to configure which entities to cache. The default is to not cache anything, even with the settings shown above. We use the `@org.hibernate.annotations.Cache` annotation to tag entity beans that needs to be cached.

```
@Entity
@Cache(usage = CacheConcurrencyStrategy.TRANSACTIONAL)
public class Account implements Serializable
{
    // ... ..
}
```

A very simplified rule of thumb is that you will typically want to do caching for objects that rarely change, and which are frequently read. You can fine tune the cache for each entity bean in the appropriate JBoss Cache configuration file, e.g. `jboss-cache-manager-jboss-beans.xml`. For instance, you can specify the size of the cache. If there are too many objects in the cache, the cache can evict the oldest or least used objects, depending on configuration, to make room for new objects. Assuming the `region_prefix` specified in `persistence.xml` was `myprefix`, the default name of the cache region for the `com.mycompany.entities.Account` entity bean would be `/myprefix/com/mycompany/entities/Account`.

```
<bean name="..." class="org.jboss.cache.config.Configuration">
    ... ..
    <property name="evictionConfig">
        <bean class="org.jboss.cache.config.EvictionConfig">
```

```

<property name="wakeupInterval">5000</property>
<!-- Overall default -->
<property name="defaultEvictionRegionConfig">
  <bean class="org.jboss.cache.config.EvictionRegionConfig">
    <property name="regionName">/</property>
    <property name="evictionAlgorithmConfig">
      <bean class="org.jboss.cache.eviction.LRUAlgorithmConfig">
        <!-- Evict LRU node once we have more than this number of
nodes -->
        <property name="maxNodes">10000</property>
        <!-- And, evict any node that has not been accessed in this
many seconds -->
        <property name="timeToLiveSeconds">1000</property>
        <!-- Do not evict a node that's been accessed within this
many seconds.
        Set this to a value greater than your max expected
transaction length. -->
        <property name="minTimeToLiveSeconds">120</property>
      </bean>
    </property>
  </bean>
</property>
<property name="evictionRegionConfigs">
  <list>
    <bean class="org.jboss.cache.config.EvictionRegionConfig">
      <property
name="regionName">/myprefix/com/mycompany/entities/Account</property>
      <property name="evictionAlgorithmConfig">
        <bean class="org.jboss.cache.eviction.LRUAlgorithmConfig">
          <property name="maxNodes">10000</property>
          <property name="timeToLiveSeconds">5000</property>
          <property name="minTimeToLiveSeconds">120</property>
        </bean>
      </property>
    </bean>
    . . . . .
  </list>
</property>
</bean>
</property>
</bean>

```

If you do not specify a cache region for an entity bean class, all instances of this class will be cached using the `defaultEvictionRegionConfig` as defined above. The `@Cache` annotation exposes an optional attribute "region" that lets you specify the cache region where an entity is to be stored, rather than having it be automatically created from the fully-qualified class name of the entity class.

```

@Entity
@Cache(usage = CacheConcurrencyStrategy.TRANSACTIONAL, region = "Account")
public class Account implements Serializable
{
  // ... ..
}

```

The eviction configuration would then become:

■



```

<bean name="..." class="org.jboss.cache.config.Configuration">
  ...
  <property name="evictionConfig">
    <bean class="org.jboss.cache.config.EvictionConfig">
      <property name="wakeupInterval">5000</property>
      <!-- Overall default -->
      <property name="defaultEvictionRegionConfig">
        <bean class="org.jboss.cache.config.EvictionRegionConfig">
          <property name="regionName">/</property>
          <property name="evictionAlgorithmConfig">
            <bean class="org.jboss.cache.eviction.LRUAlgorithmConfig">
              <property name="maxNodes">5000</property>
              <property name="timeToLiveSeconds">1000</property>
              <property name="minTimeToLiveSeconds">120</property>
            </bean>
          </property>
        </bean>
      </property>
    </bean>
  </property>
  <property name="evictionRegionConfigs">
    <list>
      <bean class="org.jboss.cache.config.EvictionRegionConfig">
        <property name="regionName">/myprefix/Account</property>
        <property name="evictionAlgorithmConfig">
          <bean class="org.jboss.cache.eviction.LRUAlgorithmConfig">
            <property name="maxNodes">10000</property>
            <property name="timeToLiveSeconds">5000</property>
            <property name="minTimeToLiveSeconds">120</property>
          </bean>
        </property>
      </bean>
    </list>
  </property>
</bean>

```

### 24.1.3. Query result caching

The EJB3 Query API also provides means for you to save the results (i.e., collections of primary keys of entity beans, or collections of scalar values) of specified queries in the second-level cache. Here we show a simple example of annotating a bean with a named query, also providing the Hibernate-specific hints that tells Hibernate to cache the query.

First, in persistence.xml you need to tell Hibernate to enable query caching:

```
<property name="hibernate.cache.use_query_cache" value="true"/>
```

Next, you create a named query associated with an entity, and tell Hibernate you want to cache the results of that query:

```

@Entity
@Cache(usage = CacheConcurrencyStrategy.TRANSACTIONAL, region = "Account")
@NamedQueries(

```

```

{
    @NamedQuery(
        name = "account.bybranch",
        query = "select acct from Account as acct where acct.branch = ?1",
        hints = { @QueryHint(name = "org.hibernate.cacheable", value = "true")
    }
    )
})
public class Account implements Serializable
{
    // ... ..
}

```

The `@NamedQueries`, `@NamedQuery` and `@QueryHint` annotations are all in the `javax.persistence` package. See the Hibernate and EJB3 documentation for more on how to use EJB3 queries and on how to instruct EJB3 to cache queries.

By default, Hibernate stores query results in JBoss Cache in a region named `<region_prefix>/org/hibernate/cache/StandardQueryCache`. Based on this, you can set up separate eviction handling for your query results. So, if the region prefix were set to `myprefix` in `persistence.xml`, you could, for example, create this sort of eviction handling:

```

<bean name="..." class="org.jboss.cache.config.Configuration">
    ... ..
    <property name="evictionConfig">
        <bean class="org.jboss.cache.config.EvictionConfig">
            <property name="wakeupInterval">5000</property>
            <!-- Overall default -->
            <property name="defaultEvictionRegionConfig">
                <bean class="org.jboss.cache.config.EvictionRegionConfig">
                    <property name="regionName"></property>
                    <property name="evictionAlgorithmConfig">
                        <bean
class="org.jboss.cache.eviction.LRUAlgorithmConfig">
                            <property name="maxNodes">5000</property>
                            <property name="timeToLiveSeconds">1000</property>
                            <property name="minTimeToLiveSeconds">120</property>
                        </bean>
                    </property>
                </bean>
            </property>
            <property name="evictionRegionConfigs">
                <list>
                    <bean class="org.jboss.cache.config.EvictionRegionConfig">
                        <property
name="regionName">/myprefix/Account</property>
                        <property name="evictionAlgorithmConfig">
                            <bean
class="org.jboss.cache.eviction.LRUAlgorithmConfig">
                                <property name="maxNodes">10000</property>
                                <property
name="timeToLiveSeconds">5000</property>
                                <property
name="minTimeToLiveSeconds">120</property>
                            </bean>
                        </property>
                    </bean>
                </list>
            </property>
        </bean>
    </property>

```

```

        </bean>
        <bean class="org.jboss.cache.config.EvictionRegionConfig">
            <property
name="regionName">/myprefix/org/hibernate/cache/StandardQueryCache</proper
ty>
                <property name="evictionAlgorithmConfig">
                    <bean
class="org.jboss.cache.eviction.LRUAlgorithmConfig">
                        <property name="maxNodes">100</property>
                        <property name="timeToLiveSeconds">600</property>
                        <property
name="minTimeToLiveSeconds">120</property>
                    </bean>
                </property>
            </bean>
        </list>
    </property>
</bean>
</property>
</bean>

```

The `@NamedQuery.hints` attribute shown above takes an array of vendor-specific `@QueryHints` as a value. Hibernate accepts the `"org.hibernate.cacheRegion"` query hint, where the value is the name of a cache region to use instead of the default `/org/hibernate/cache/StandardQueryCache`. For example:

```

@Entity
@Cache(usage = CacheConcurrencyStrategy.TRANSACTIONAL, region = "Account")
@NamedQueries(
{
    @NamedQuery(
        name = "account.bybranch",
        query = "select acct from Account as acct where acct.branch = ?1",
        hints =
        {
            @QueryHint(name = "org.hibernate.cacheable", value = "true"),
            @QueryHint(name = "org.hibernate.cacheRegion", value = "Queries")
        }
    )
})
public class Account implements Serializable
{
    // ... ..
}

```

The related eviction configuration:

```

<bean name="..." class="org.jboss.cache.config.Configuration">
    ... ..
    <property name="evictionConfig">
        <bean class="org.jboss.cache.config.EvictionConfig">
            <property name="wakeupInterval">5000</property>
            <!-- Overall default -->
            <property name="defaultEvictionRegionConfig">
                <bean class="org.jboss.cache.config.EvictionRegionConfig">
                    <property name="regionName">/</property>
                    <property name="evictionAlgorithmConfig">

```

```

        <bean
class="org.jboss.cache.eviction.LRUAlgorithmConfig">
    <property name="maxNodes">5000</property>
    <property name="timeToLiveSeconds">1000</property>
    <property name="minTimeToLiveSeconds">120</property>
    </bean>
</property>
</bean>
</property>
<property name="evictionRegionConfigs">
    <list>
        <bean class="org.jboss.cache.config.EvictionRegionConfig">
            <property
name="regionName">/myprefix/Account</property>
            <property name="evictionAlgorithmConfig">
                <bean
class="org.jboss.cache.eviction.LRUAlgorithmConfig">
                    <property name="maxNodes">10000</property>
                    <property
name="timeToLiveSeconds">5000</property>
                    <property
name="minTimeToLiveSeconds">120</property>
                </bean>
            </property>
        </bean>
        <bean class="org.jboss.cache.config.EvictionRegionConfig">
            <property
name="regionName">/myprefix/Queries</property>
            <property name="evictionAlgorithmConfig">
                <bean
class="org.jboss.cache.eviction.LRUAlgorithmConfig">
                    <property name="maxNodes">100</property>
                    <property name="timeToLiveSeconds">600</property>
                    <property
name="minTimeToLiveSeconds">120</property>
                </bean>
            </property>
        </bean>
        ... ..
    </list>
</property>
</bean>
</property>
</bean>

```

## 24.2. ENTITY BEANS IN EJB 2.X



## IMPORTANT

Clustering 2.x entity beans is not advised.

Doing so exposes elements that generally are too fine grained for use as remote objects to clustered remote objects and introduces data synchronization problems that are non-trivial.

Do not use EJB 2.x entity bean clustering unless you are in the unique situation of using read-only, or one read-write node with read-only nodes synchronized with the cache invalidation services.

To use a clustered entity bean, the application does not need to do anything special, except for looking up EJB 2.x remote bean references from the clustered HA-JNDI.

To cluster EJB 2.x entity beans, you need to add the `<clustered>` element to the application's `jboss.xml` descriptor file. Below is a typical `jboss.xml` file.

```
<jboss>
  <enterprise-beans>
    <entity>
      <ejb-name>nextgen.EnterpriseEntity</ejb-name>
      <jndi-name>nextgen.EnterpriseEntity</jndi-name>
      <clustered>True</clustered>
      <cluster-config>
        <partition-name>DefaultPartition</partition-name>
        <home-load-balance-
policy>org.jboss.ha.framework.interfaces.RoundRobin</home-load-balance-
policy>
        <bean-load-balance-
policy>org.jboss.ha.framework.interfaces.FirstAvailable</bean-load-
balance-policy>
      </cluster-config>
    </entity>
  </enterprise-beans>
</jboss>
```

The EJB 2.x entity beans are clustered for load balanced remote invocations. All the bean instances are synchronized to have the same contents on all nodes.

However, clustered EJB 2.x Entity Beans do not have a distributed locking mechanism or a distributed cache. They can only be synchronized by using row-level locking at the database level (see `<row-lock>` in the CMP specification) or by setting the Transaction Isolation Level of your JDBC driver to be `TRANSACTION_SERIALIZABLE`. Because there is no supported distributed locking mechanism or distributed cache Entity Beans use Commit Option "B" by default (see `standardjboss.xml` and the container configurations `Clustered CMP 2.x EntityBean`, `Clustered CMP EntityBean`, or `Clustered BMP EntityBean`). It is not recommended that you use Commit Option "A" unless your Entity Bean is read-only.



## NOTE

If you are using Bean Managed Persistence (BMP), you are going to have to implement synchronization on your own.

## CHAPTER 25. HTTP SERVICES

Installing and configuring HTTP Services such as `mod_jk` and `mod_cluster` is covered in detail in the *HTTP Connectors Load Balancing Guide*

## CHAPTER 26. JBOSS MESSAGING CLUSTERING NOTES

The most current information about using JBoss Messaging in a clustered environment is always available from the relevant *JBoss Messaging User Guide* at <https://access.redhat.com/knowledge/docs/>.

## CHAPTER 27. CLUSTERED DEPLOYMENT OPTIONS

### 27.1. CLUSTERED SINGLETON SERVICES

A clustered singleton service (also known as a HA singleton) is a service that is deployed on multiple nodes in a cluster, but is providing its service on only one of the nodes. The node running the singleton service is typically called the master node.

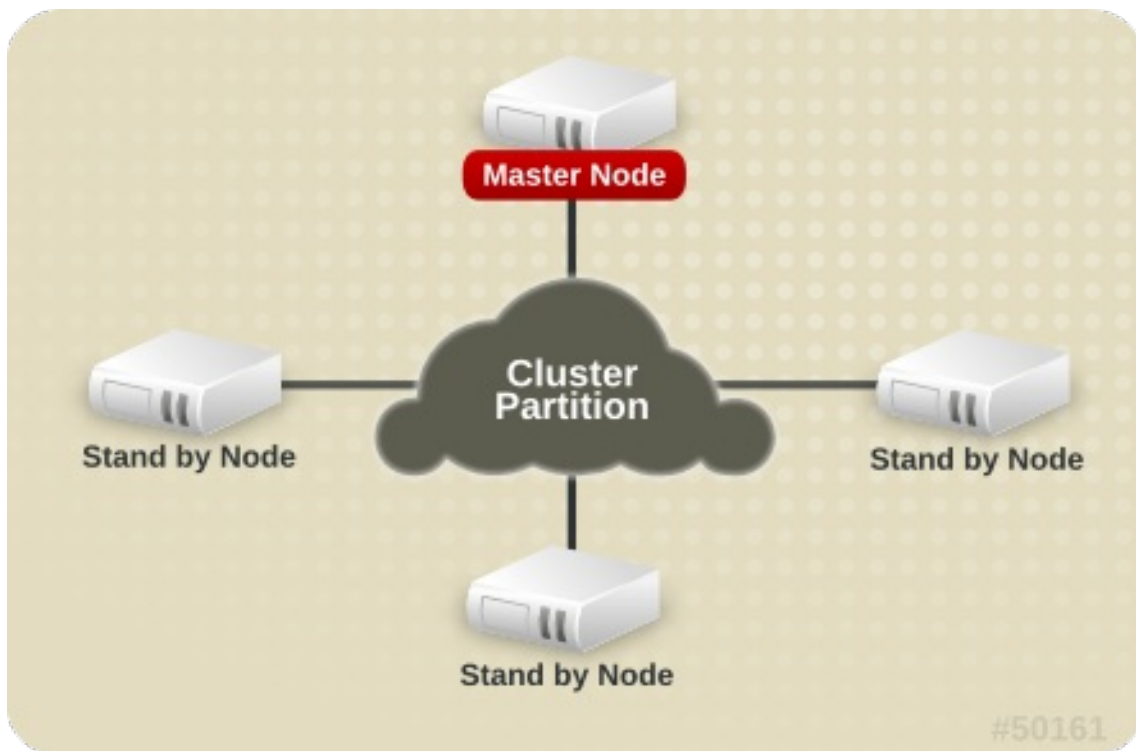

Figure 27.1. Topology before the Master Node fails

When the master fails or is shut down, another master is selected from the remaining nodes and the service is restarted on the new master. Thus, other than a brief interval when one master has stopped and another has yet to take over, the service is always being provided by one but only one node.



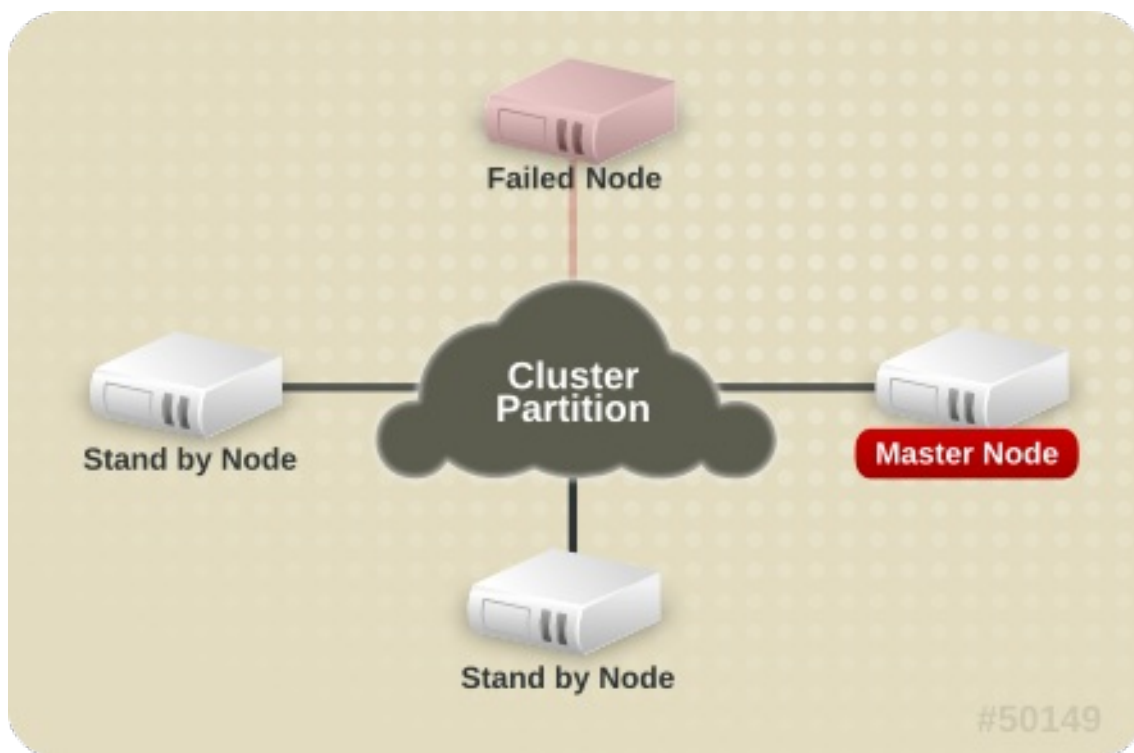

Figure 27.2. Topology after the Master Node fails

### 27.1.1. HASingleton Deployment Options

The JBoss Enterprise Application Platform provides support for a number of strategies for helping you deploy clustered singleton services. In this section we will explore the different strategies. All of the strategies are built on top of the `HAPartition` service described in the introduction. They rely on the `HAPartition` to provide notifications when different nodes in the cluster start and stop; based on those notifications each node in the cluster can independently (but consistently) determine if it is now the master node and needs to begin providing a service.

#### 27.1.1.1. HASingletonDeployer service

The simplest and most commonly used strategy for deploying an HA singleton is to take an ordinary deployment (war, ear, jar, whatever you would normally put in `deploy`) and deploy it in the `<JBOSS_HOME>/server/<PROFILE>/deploy-hasingleton` directory instead of in `deploy`. The `deploy-hasingleton` directory does not lie under `deploy` nor `farm` directories, so its contents are not automatically deployed when an Enterprise Application Platform instance starts. Instead, deploying the contents of this directory is the responsibility of a special service, the `HASingletonDeployer` bean (which itself is deployed via the `deploy/deploy-hasingleton-jboss-beans.xml` file). The `HASingletonDeployer` service is itself an HA Singleton, one whose provided service, when it becomes master, is to deploy the contents of `deploy-hasingleton`; and whose service, when it stops being the master (typically at server shutdown), is to undeploy the contents of `deploy-hasingleton`.

So, by placing your deployments in `deploy-hasingleton` you know that they will be deployed only on the master node in the cluster. If the master node cleanly shuts down, they will be cleanly undeployed as part of shutdown. If the master node fails or is shut down, they will be deployed on whatever node takes over as master.

Using `deploy-hasingleton` is very simple, but it does have two drawbacks:

- There is no hot-deployment feature for services in `deploy-hasingleton`. Redeploying a service that has been deployed to `deploy-hasingleton` requires a server restart.
- If the master node fails and another node takes over as master, your singleton service needs to go through the entire deployment process before it will be providing services. Depending on the complexity of your service's deployment, and the extent of start up activity in which it engages, this could take a while, during which time the service is not being provided.

### 27.1.1.2. POJO deployments using HASingletonController

If your service is a POJO (i.e., not a J2EE deployment like an ear or war or jar), you can deploy it along with a service called an `HASingletonController` in order to turn it into an HA singleton. It is the job of the `HASingletonController` to work with the `HAPartition` service to monitor the cluster and determine if it is now the master node for its service. If it determines it has become the master node, it invokes a method on your service telling it to begin providing service. If it determines it is no longer the master node, it invokes a method on your service telling it to stop providing service. Let us walk through an illustration.

First, we have a POJO that we want to make an HA singleton. The only thing special about it is it needs to expose a public method that can be called when it should begin providing service, and another that can be called when it should stop providing service:

```
public interface HASingletonExampleMBean
{
    boolean isMasterNode();
}

public class HASingletonExample implements HASingletonExampleMBean
{
    private boolean isMasterNode = false;

    public boolean isMasterNode()
    {
        return isMasterNode;
    }

    public void startSingleton()
    {
        isMasterNode = true;
    }

    public void stopSingleton()
    {
        isMasterNode = false;
    }
}
```

We used `startSingleton` and `stopSingleton` in the above example, but you could name the methods anything.

Next, we deploy our service, along with an `HASingletonController` to control it, most likely packaged in a `.sar` file, with the following `META-INF/jboss-beans.xml`:

```
<deployment xmlns="urn:jboss:bean-deployer:2.0">
  <!-- This bean is an example of a clustered singleton -->
```

```

<bean name="HASingletonExample"
class="org.jboss.ha.examples.HASingletonExample">
  <annotation>@org.jboss.aop.microcontainer.aspects.jmx.JMX
(name="jboss:service=HASingletonExample",
exposedInterface=org.jboss.ha.examples.HASingletonExampleMBean.class)</ann
otation>
</bean>

<bean name="ExampleHASingletonController"
class="org.jboss.ha.singleton.HASingletonController">

<annotation>@org.jboss.aop.microcontainer.aspects.jmx.JMX(name="jboss:service=ExampleHASingletonController",
exposedInterface=org.jboss.ha.singleton.HASingletonControllerMBean.class,
registerDirectly=true)</annotation>
  <property name="HAPartition"><inject bean="HAPartition"/></property>
  <property name="target"><inject bean="HASingletonExample"/></property>
  <property name="targetStartMethod">startSingleton</property>
  <property name="targetStopMethod">stopSingleton</property>
</bean>
</deployment>

```

- 1 While the `<annotation>` line in the code sample above has been broken across multiple lines for formatting, ensure it is on a single line if you copy it into a configuration file. The configuration will not work if this line is broken.

The primary advantage of this approach over `deploy-ha-singleton` is that the above example can be placed in `deploy` or `farm` and thus can be hot deployed and farmed deployed. Also, if our example service had complex, time-consuming start up requirements, those could potentially be implemented in `create()` or `start()` methods. JBoss will invoke `create()` and `start()` as soon as the service is deployed; it does not wait until the node becomes the master node. So, the service could be primed and ready to go, just waiting for the controller to implement `startSingleton()` at which point it can immediately provide service.

Although not demonstrated in the example above, the `HASingletonController` can support an optional argument for either or both of the target start and stop methods. These are specified using the `targetStartMethodArgument` and `targetStopMethodArgument` properties, respectively. Currently, only string values are supported.

### 27.1.1.3. HASingleton deployments using a Barrier

Services deployed normally inside `deploy` or `farm` that want to be started/stopped whenever the content of `deploy-hasingleton` gets deployed/undeployed, (i.e., whenever the current node becomes the master), need only specify a dependency on the Barrier service:

```
<depends>jboss.ha:service=HASingletonDeployer,type=Barrier</depends>
```

The way it works is that a `BarrierController` is deployed along with the `HASingletonDeployer` and listens for JMX notifications from it. A `BarrierController` is a relatively simple MBean that can subscribe to receive any JMX notification in the system. It uses the received notifications to control the lifecycle of a dynamically created MBean called the Barrier. The Barrier is instantiated, registered and brought to the `CREATE` state when the `BarrierController` is deployed. After that, the `BarrierController` starts

and stops the Barrier when matching JMX notifications are received. Thus, other services need only depend on the Barrier bean using the usual `<depends>` tag, and they will be started and stopped in tandem with the Barrier. When the BarrierController is undeployed the Barrier is also destroyed.

This provides an alternative to the deploy-hasingleton approach in that we can use farming to distribute the service, while content in deploy-hasingleton must be copied manually on all nodes.

On the other hand, the barrier-dependent service will be instantiated/created (i.e., any `create()` method invoked) on all nodes, but only started on the master node. This is different with the deploy-hasingleton approach that will only deploy (instantiate/create/start) the contents of the deploy-hasingleton directory on one of the nodes.

So services depending on the barrier will need to make sure they do minimal or no work inside their `create()` step, rather they should use `start()` to do the work.



#### NOTE

The Barrier controls the start/stop of dependent services, but not their destruction, which happens only when the `BarrierController` is itself destroyed/undeployed. Thus using the `Barrier` to control services that need to be "destroyed" as part of their normal "undeploy" operation (like, for example, an `EJBContainer`) will not have the desired effect.

### 27.1.2. Determining the master node

The various clustered singleton management strategies all depend on the fact that each node in the cluster can independently react to changes in cluster membership and correctly decide whether it is now the "master node". How is this done?

For each member of the cluster, the `HAPartition` service maintains an attribute called the `CurrentView`, which is basically an ordered list of the current members of the cluster. As nodes join and leave the cluster, `JGroups` ensures that each surviving member of the cluster gets an updated view. You can see the current view by going into the JMX console, and looking at the `CurrentView` attribute in the `jboss:service=DefaultPartition` mbean. Every member of the cluster will have the same view, with the members in the same order.

Let us say, for example, that we have a 4 node cluster, nodes A through D, and the current view can be expressed as {A, B, C, D}. Generally speaking, the order of nodes in the view will reflect the order in which they joined the cluster (although this is not always the case, and should not be assumed to be the case).

To further our example, let us say there is a singleton service (i.e. an `HASingletonController`) named `Foo` that's deployed around the cluster, except, for whatever reason, on B. The `HAPartition` service maintains across the cluster a registry of what services are deployed where, in view order. So, on every node in the cluster, the `HAPartition` service knows that the view with respect to the `Foo` service is {A, C, D} (no B).

Whenever there is a change in the cluster topology of the `Foo` service, the `HAPartition` service invokes a callback on `Foo` notifying it of the new topology. So, for example, when `Foo` started on D, the `Foo` service running on A, C and D all got callbacks telling them the new view for `Foo` was {A, C, D}. That callback gives each node enough information to independently decide if it is now the master. The `Foo` service on each node uses the `HAPartition`'s `HASingletonElectionPolicy` to determine if they are the master, as explained in the [Section 27.1.2.1, "HA singleton election policy"](#).

If A were to fail or shutdown, `Foo` on C and D would get a callback with a new view for `Foo` of {C, D}. C

would then become the master. If A restarted, A, C and D would get a callback with a new view for Foo of {C, D, A}. C would remain the master – there's nothing magic about A that would cause it to become the master again just because it was before.

### 27.1.2.1. HA singleton election policy

The `HASingletonElectionPolicy` object is responsible for electing a master node from a list of available nodes, on behalf of an HA singleton, following a change in cluster topology.

```
public interface HASingletonElectionPolicy
{
    ClusterNode elect(List<ClusterNode> nodes);
}
```

JBoss Enterprise Application Platform ships with two election policies:

#### `HASingletonElectionPolicySimple`

This policy selects a master node based relative age. The desired age is configured via the `position` property, which corresponds to the index in the list of available nodes. `position = 0`, the default, refers to the oldest node; `position = 1`, refers to the 2nd oldest; etc. `position` can also be negative to indicate youngness; imagine the list of available nodes as a circular linked list. `position = -1`, refers to the youngest node; `position = -2`, refers to the 2nd youngest node; etc.

```
<bean class="org.jboss.ha.singleton.HASingletonElectionPolicySimple">
    <property name="position">-1</property>
</bean>
```

#### `PreferredMasterElectionPolicy`

This policy extends `HASingletonElectionPolicySimple`, allowing the configuration of a preferred node. The `preferredMaster` property, specified as `host:port` or `address:port`, identifies a specific node that should become master, if available. If the preferred node is not available, the election policy will behave as described above.

```
<bean class="org.jboss.ha.singleton.PreferredMasterElectionPolicy">
    <property name="preferredMaster">server1:12345</property>
</bean>
```

## 27.2. FARMING DEPLOYMENT

The easiest way to deploy an application into the cluster is to use the farming service. Using the farming service, you can deploy an application (e.g. EAR, WAR, or SAR; either an archive file or in exploded form) to the `all/farm/` directory of any cluster member and the application will be automatically duplicate across all nodes in the same cluster. If a node joins the cluster later, it will pull in all farm deployed applications in the cluster and deploy them locally at start-up time. If you delete the application from a running clustered server node's `farm/` directory, the application will be undeployed locally and then removed from all other clustered server nodes' `farm/` directories (triggering undeployment).

Farming is enabled by default in the `all` configuration in JBoss Enterprise Application Platform and thus requires no manual setup. The required `farm-deployment-jboss-beans.xml` and

`timestamps-jboss-beans.xml` configuration files are located in the `deploy/cluster` directory. If you want to enable farming in a custom configuration, simply copy these files to the corresponding JBoss deploy directory `<JBOSS_HOME>/server/<PROFILE>/deploy/cluster`. Make sure that your custom configuration has clustering enabled.

While there is little need to customize the farming service, it can be customized via the `FarmProfileRepositoryClusteringHandler` bean, whose properties and default values are listed below:

```
<bean name="FarmProfileRepositoryClusteringHandler"
      class="org.jboss.profileservice.cluster.repository.
      DefaultRepositoryClusteringHandler">

  <property name="partition"><inject bean="HAPartition"/></property>
  <property name="profileDomain">default</property>
  <property name="profileServer">default</property>
  <property name="profileName">farm</property>
  <property name="immutable">>false</property>
  <property name="lockTimeout">60000</property><!-- 1 minute -->
  <property name="methodCallTimeout">60000</property><!-- 1 minute -->
  <property name="synchronizationPolicy"><inject
bean="FarmProfileSynchronizationPolicy"/></property>
</bean>
```

- `partition` is a required attribute to inject the `HAPartition` service that the farm service uses for intra-cluster communication.
- `profile[Domain|Server|Name]` are all used to identify the server profile for which this handler is intended.
- `immutable` indicates whether or not this handler allows a node to push content changes to the cluster. A value of `true` is equivalent to setting `synchronizationPolicy` to `org.jboss.system.server.profileservice.repository.clustered.sync.ImmutableSynchronizationPolicy`.
- `lockTimeout` defines the number of milliseconds to wait for cluster-wide lock acquisition.
- `methodCallTimeout` defines the number of milliseconds to wait for invocations on remote cluster nodes.
- `synchronizationPolicy` decides how to handle content additions, reincarnations, updates, or removals from nodes attempting to join the cluster or from cluster merges. The policy is consulted on the "authoritative" node, i.e. the master node for the service on the cluster. *Reincarnation* refers to the phenomenon where a newly started node may contain an application in its `farm/` directory that was previously removed by the farming service but might still exist on the starting node if it was not running when the removal took place. The default synchronization policy is defined as follows:

```
<bean name="FarmProfileSynchronizationPolicy"
      class="org.jboss.profileservice.cluster.repository.
      DefaultSynchronizationPolicy">
  <property name="allowJoinAdditions"><null/></property>
  <property name="allowJoinReincarnations"><null/></property>
  <property name="allowJoinUpdates"><null/></property>
  <property name="allowJoinRemovals"><null/></property>
  <property name="allowMergeAdditions"><null/></property>
```

```

<property name="allowMergeReincarnations"><null/></property>
<property name="allowMergeUpdates"><null/></property>
<property name="allowMergeRemovals"><null/></property>
<property name="developerMode">false</property>
<property name="removalTrackingTime">2592000000</property><!-- 30
days -->
<property name="timestampService"><inject
bean="TimestampDiscrepancyService"/></property>
</bean>

```

- **allow[Join|Merge][Additions|Reincarnations|Updates|Removals]** define fixed responses to requests to allow additions, reincarnations, updates, or removals from joined or merged nodes.
- **developerMode** enables a lenient synchronization policy that allows all changes. Enabling developer mode is equivalent to setting each of the above properties to `true` and is intended for development environments.
- **removalTrackingTime** defines the number of milliseconds for which this policy should remember removed items, for use in detecting reincarnations.
- **timestampService** estimates and tracks discrepancies in system clocks for current and past members of the cluster. Default implementation is defined in `timestamps-jboss-beans.xml`.

## CHAPTER 28. JGROUPS SERVICES

JGroups provides the underlying group communication support for JBoss Enterprise Application Platform clusters. The interaction of clustered services with JGroups was covered in [Section 21.1, “Group Communication with JGroups”](#). This chapter focuses on the details of this interaction, with particular attention to configuration details and troubleshooting tips.

This chapter is not intended as complete JGroups documentation. If you want to know more about JGroups, you can consult:

- The JGroups project documentation at <http://jgroups.org/ug.html>
- The JGroups wiki pages at [jboss.org](https://www.jboss.org/community/wiki/JGroups), rooted at <https://www.jboss.org/community/wiki/JGroups>

The first section of this chapter covers the many JGroups configuration options in detail. JBoss Enterprise Application Platform ships with a set of default JGroups configurations. Most applications will work with the default configurations out of the box. You will only need to edit these configurations when you deploy an application with special network or performance requirements.

### 28.1. CONFIGURING A JGROUPS CHANNEL'S PROTOCOL STACK

The JGroups framework provides services to enable peer-to-peer communications between nodes in a cluster. Communication occurs over a communication channel. The channel built up from a stack of network communication *protocols*, each of which is responsible for adding a particular capability to the overall behavior of the channel. Key capabilities provided by various protocols include transport, cluster discovery, message ordering, lossless message delivery, detection of failed peers, and cluster membership management services.

[Figure 28.1, “Protocol stack in JGroups”](#) shows a conceptual cluster with each member's channel composed of a stack of JGroups protocols.

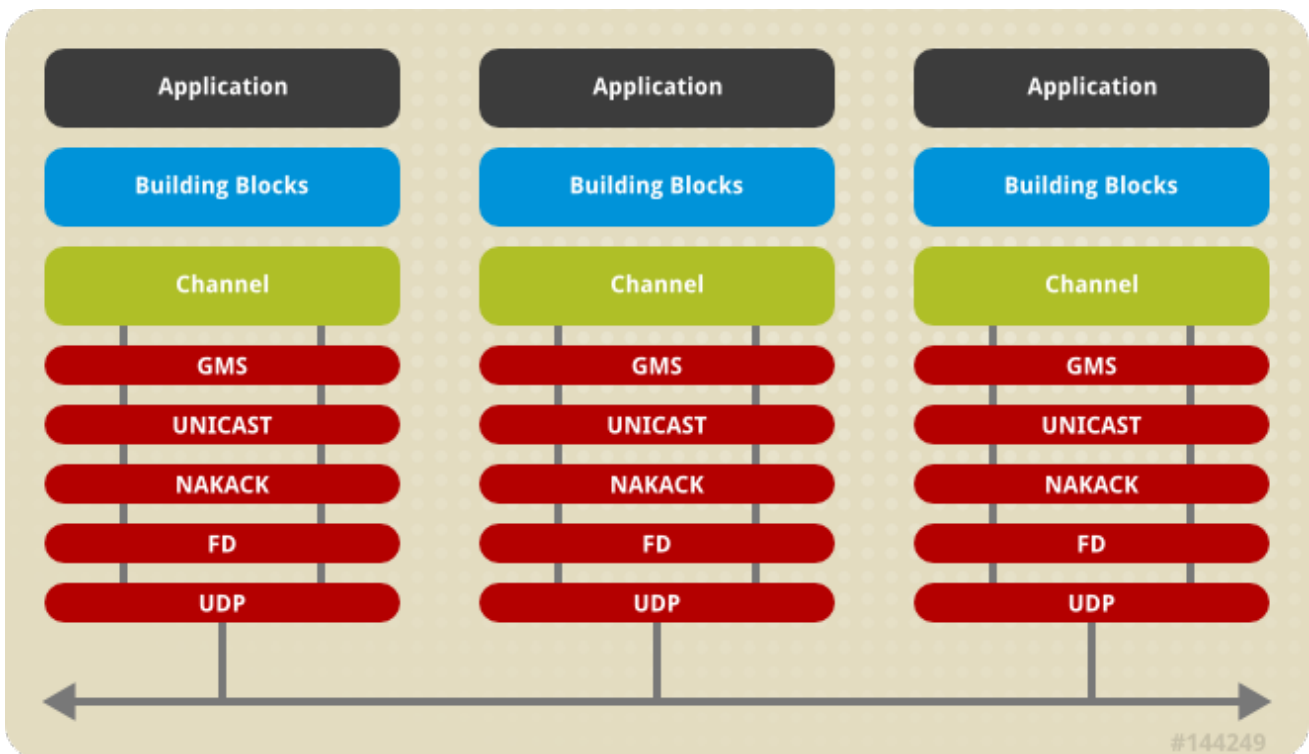

Figure 28.1. Protocol stack in JGroups



This section of the chapter covers some of the most commonly used protocols, according to the type of behavior they add to the channel. We discuss a few key configuration attributes exposed by each protocol, but since these attributes should be altered only by experts, this chapter focuses on familiarizing users with the purpose of various protocols.

The JGroups configurations used in JBoss Enterprise Application Platform appear as nested elements in the `<JBoss_HOME>/server/<PROFILE>/deploy/cluster/jgroups-channel-factory.sar/META-INF/jgroups-channel-factory-stacks.xml` file. This file is parsed by the `ChannelFactory` service, which uses the contents to provide correctly configured channels to the clustered services that require them. See [Section 21.1.1, “The Channel Factory Service”](#) for more on the `ChannelFactory` service.

The following is an example protocol stack configuration from `jgroups-channel-factory-stacks.xml`:

```
<stack name="udp-async"
      description="Same as the default 'udp' stack above, except
message bundling
      is enabled in the transport protocol
(enable_bundling=true).
      Useful for services that make high-volume
asynchronous
      RPCs (e.g. high volume JBoss Cache instances
configured
      for REPL_ASYNC) where message bundling may
improve performance.">
  <config>
    <UDP
      singleton_name="udp-async"
      mcast_port="{jboss.jgroups.udp_async.mcast_port:45689}"
      mcast_addr="{jboss.partition.udpGroup:228.11.11.11}"
      tos="8"
      ucast_recv_buf_size="20000000"
      ucast_send_buf_size="640000"
      mcast_recv_buf_size="25000000"
      mcast_send_buf_size="640000"
      loopback="true"
      discard_incompatible_packets="true"
      enable_bundling="true"
      max_bundle_size="64000"
      max_bundle_timeout="30"
      ip_ttl="{jgroups.udp.ip_ttl:2}"
      thread_naming_pattern="cl"
      timer.num_threads="12"

enable_diagnostics="{jboss.jgroups.enable_diagnostics:true}"

diagnostics_addr="{jboss.jgroups.diagnostics_addr:224.0.0.75}"
      diagnostics_port="{jboss.jgroups.diagnostics_port:7500}"

      thread_pool.enabled="true"
      thread_pool.min_threads="8"
      thread_pool.max_threads="200"
      thread_pool.keep_alive_time="5000"
      thread_pool.queue_enabled="true"
      thread_pool.queue_max_size="1000"
```

```

        thread_pool.rejection_policy="discard"

        oob_thread_pool.enabled="true"
        oob_thread_pool.min_threads="8"
        oob_thread_pool.max_threads="200"
        oob_thread_pool.keep_alive_time="1000"
        oob_thread_pool.queue_enabled="false"
        oob_thread_pool.rejection_policy="discard"/>
<PING timeout="2000" num_initial_members="3"/>
<MERGE2 max_interval="100000" min_interval="20000"/>
<FD_SOCKET/>
<FD timeout="6000" max_tries="5" shun="true"/>
<VERIFY_SUSPECT timeout="1500"/>
<BARRIER/>
<pbcast.NAKACK use_mcast_xmit="true" gc_lag="0"
    retransmit_timeout="300,600,1200,2400,4800"
    discard_delivered_msgs="true"/>
<UNICAST timeout="300,600,1200,2400,3600"/>
<pbcast.STABLE stability_delay="1000"
desired_avg_gossip="50000"
    max_bytes="400000"/>
<VIEW_SYNC avg_send_interval="10000"/>
<pbcast.GMS print_local_addr="true" join_timeout="3000"
    shun="true"
    view_bundling="true"
    view_ack_collection_timeout="5000"
    resume_task_timeout="7500"/>
<FC max_credits="2000000" min_threshold="0.10"
    ignore_synchronous_response="true"/>
<FRAG2 frag_size="60000"/>
<!-- pbcast.STREAMING_STATE_TRANSFER/ -->
<pbcast.STATE_TRANSFER/>
<pbcast.FLUSH timeout="0" start_flush_timeout="10000"/>
</config>
</stack>

```

The `<config>` element contains all the configuration data for JGroups. This information is used to configure a JGroups *channel*, which is conceptually similar to a socket, and manages communication between peers in a cluster. Each element within the `<config>` element defines a particular JGroups *protocol*. Each protocol performs one function. The combination of these functions defines the characteristics of the channel as a whole. The next few sections describe common protocols and explain the options available to each.

### 28.1.1. Common Configuration Properties

The following property is exposed by all of the JGroups protocols discussed below:

- **stats** - indicates whether the protocol should gather runtime statistics on its operations. These statistics can be exposed via tools like the JMX Console or the JGroups Probe utility. What, if any, statistics are gathered depends on the protocol. Default is `true`.

**NOTE**

All protocols in the versions of JGroups used in JBoss Enterprise Application Platform 4 and earlier exposed the `down_thread` and `up_thread` attributes. The JGroups version included in JBoss Enterprise Application Platform 5 and later no longer uses those attributes, and a **WARN** message will be written to the server log if they are configured for any protocol.

## 28.1.2. Transport Protocols

The transport protocols send and receive messages to and from the network. They also manage the thread pools used to deliver incoming messages to addresses higher in the protocol stack. JGroups supports **UDP**, **TCP** and **TUNNEL** as transport protocols.

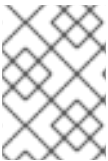
**NOTE**

The **UDP**, **TCP**, and **TUNNEL** protocols are mutually exclusive. You can only have one transport protocol in each JGroups **Config** element

### 28.1.2.1. UDP configuration

UDP is the preferred transport protocol for JGroups. UDP uses multicast (or, in an unusual configuration, multiple unicasts) to send and receive messages. If you choose UDP as the transport protocol for your cluster service, you need to configure it in the **UDP** sub-element in the JGroups **config** element. Here is an example.

```
<UDP
  singleton_name="udp-async"
  mcast_port="${jboss.jgroups.udp_async.mcast_port:45689}"
  mcast_addr="${jboss.partition.udpGroup:228.11.11.11}"
  tos="8"
  ucast_recv_buf_size="20000000"
  ucast_send_buf_size="640000"
  mcast_recv_buf_size="25000000"
  mcast_send_buf_size="640000"
  loopback="true"
  discard_incompatible_packets="true"
  enable_bundling="true"
  max_bundle_size="64000"
  max_bundle_timeout="30"
  ip_ttl="${jgroups.udp.ip_ttl:2}"
  thread_naming_pattern="cl"
  timer.num_threads="12"

enable_diagnostics="${jboss.jgroups.enable_diagnostics:true}"

diagnostics_addr="${jboss.jgroups.diagnostics_addr:224.0.0.75}"
  diagnostics_port="${jboss.jgroups.diagnostics_port:7500}"

  thread_pool.enabled="true"
  thread_pool.min_threads="8"
  thread_pool.max_threads="200"
  thread_pool.keep_alive_time="5000"
  thread_pool.queue_enabled="true"
```

```
thread_pool.queue_max_size="1000"
thread_pool.rejection_policy="discard"

oob_thread_pool.enabled="true"
oob_thread_pool.min_threads="8"
oob_thread_pool.max_threads="200"
oob_thread_pool.keep_alive_time="1000"
oob_thread_pool.queue_enabled="false"
oob_thread_pool.rejection_policy="discard"/>
```

JGroups transport configurations have a number of attributes available. First we look at the attributes available to the **UDP** protocol, followed by the attributes that are also used by the **TCP** and **TUNNEL** transport protocols.

The attributes particular to the **UDP** protocol are:

- **ip\_mcast** specifies whether or not to use IP multicasting. The default is `true`. If set to `false`, multiple unicast packets will be sent instead of one multicast packet. Any packet sent via **UDP** protocol are UDP datagrams.
- **mcast\_addr** specifies the multicast address (class D) for communicating with the group (i.e., the cluster). The standard protocol stack configurations in JBoss Enterprise Application Platform use the value of system property `jboss.partition.udpGroup`, if set, as the value for this attribute. Using the `-u` command line switch when starting JBoss Enterprise Application Platform sets that value. See [Section 28.6.2, “Isolating JGroups Channels”](#) for information about using this configuration attribute to ensure that JGroups channels are properly isolated from one another. If this attribute is omitted, the default value is `228.11.11.11`.
- **mcast\_port** specifies the port to use for multicast communication with the group. See [Section 28.6.2, “Isolating JGroups Channels”](#) for how to use this configuration attribute to ensure JGroups channels are properly isolated from one another. If this attribute is omitted, the default is `45688`.
- **mcast\_send\_buf\_size**, **mcast\_rcv\_buf\_size**, **ucast\_send\_buf\_size** and **ucast\_rcv\_buf\_size** define the socket send and receive buffer sizes that JGroups will request from the operating system. A large buffer size helps to ensure that packets are not dropped due to buffer overflow. However, socket buffer sizes are limited at the operating system level, so obtaining the desired buffer may require configuration at the operating system level. See [Section 28.6.2.3, “Improving UDP Performance by Configuring OS UDP Buffer Limits”](#) for further details.
- **bind\_port** specifies the port to which the unicast receive socket should be bound. The default is `0`; i.e. use an ephemeral port.
- **port\_range** specifies the number of ports to try if the port identified by **bind\_port** is not available. The default is `1`, which specifies that only **bind\_port** will be tried.
- **ip\_ttl** specifies time-to-live (TTL) for IP Multicast packets. TTL is the commonly used term in multicast networking, but is actually something of a misnomer, since the value here refers to how many network hops a packet will be allowed to travel before networking equipment will drop it.
- **tos** specifies the traffic class for sending unicast and multicast datagrams.

The attributes that are common to all transport protocols, and thus have the same meanings when used with **TCP** or **TUNNEL**, are:

- **singleton\_name** provides a unique name for this transport protocol configuration. Used by the application server's **ChannelFactory** to support sharing of a transport protocol instance by different channels that use the same transport protocol configuration. See [Section 21.1.2, “The JGroups Shared Transport”](#).
- **bind\_addr** specifies the interface on which to receive and send messages. By default, JGroups uses the value of system property **jgroups.bind\_addr**. This can also be set with the **-b** command line switch. See [Section 28.6, “Other Configuration Issues”](#) for more on binding JGroups sockets.
- **receive\_on\_all\_interfaces** specifies whether this node should listen on all interfaces for multicasts. The default is **false**. It overrides the **bind\_addr** property for receiving multicasts. However, **bind\_addr** (if set) is still used to send multicasts.
- **send\_on\_all\_interfaces** specifies whether this node sends UDP packets via all available network interface controllers, if your machine has multiple network interface controllers available. This means that the same multicast message is sent N times, so use with care.
- **receive\_interfaces** specifies a list of interfaces on which to receive multicasts. The multicast receive socket will listen on all of these interfaces. This is a comma-separated list of IP addresses or interface names, for example, **192.168.5.1, eth1, 127.0.0.1**.
- **send\_interfaces** specifies a list of interfaces via which to send multicasts. The multicast sender socket will send on all of these interfaces. This is a comma-separated list of IP addresses or interface names, for example, **192.168.5.1, eth1, 127.0.0.1**. This means that the same multicast message is sent N times, so use with care.
- **enable\_bundling** specifies whether to enable message bundling. If **true**, the transport protocol queues outgoing messages until **max\_bundle\_size** bytes have accumulated, or **max\_bundle\_time** milliseconds have elapsed, whichever occurs first. Then the transport protocol bundles queued messages into one large message and sends it. The messages are un-bundled at the receiver. The default is **false**.

Message bundling can have significant performance benefits for channels that are used for high volume sending of messages where the sender does not block waiting for a response from recipients (for example, a JBoss Cache instance configured for **REPL\_ASYNC**.) It can add considerable latency to applications where senders need to block waiting for responses, so it is not recommended for certain situations, such as where a JBoss Cache instance is configured for **REPL\_SYNC**.

- **loopback** specifies whether the thread sending a message to the group should itself carry the message back up the stack for delivery. (Messages sent to the group are always delivered to the sending node as well.) If **false**, the sending thread does not carry the message; the transport protocol waits to read the message off the network and uses one of the message delivery pool threads for delivery. The default is **false**, but **true** is recommended to ensure that the channel receives its own messages, in case the network interface goes down.
- **discard\_incompatible\_packets** specifies whether to discard packets sent by peers that use a different version of JGroups. Each message in the cluster is tagged with a JGroups version. If **discard\_incompatible\_packets** is set to **true**, messages received from different versions of JGroups will be silently discarded. Otherwise, a warning will be logged. *In no case will the message be delivered.* The default value is **false**.

- **enable\_diagnostics** specifies that the transport should open a multicast socket on address **diagnostics\_addr** and port **diagnostics\_port** to listen for diagnostic requests sent by the JGroups [Probe utility](#).
- The various **thread\_pool** attributes configure the behavior of the pool of threads JGroups uses to carry ordinary incoming messages up the stack. The various attributes provide the constructor arguments for an instance of `java.util.concurrent.ThreadPoolExecutorService`. In the example above, the pool will have a minimum or *core size* of 8 threads, and a maximum size of 200. If more than 8 pool threads have been created, a thread returning from carrying a message will wait for up to 5000 milliseconds to be assigned a new message to carry, after which it will terminate. If no threads are available to carry a message, the (separate) thread reading messages off the socket will place messages in a queue; the queue will hold up to 1000 messages. If the queue is full, the thread reading messages off the socket will discard the message.
- The various **oob\_thread\_pool** attributes are similar to the **thread\_pool** attributes in that they configure a `java.util.concurrent.ThreadPoolExecutorService` used to carry incoming messages up the protocol stack. In this case, the pool is used to carry a special type of message known as an Out-Of-Band (OOB) message. OOB messages are exempt from the ordered-delivery requirements of protocols like NAKACK and UNICAST and thus can be delivered up the stack even if NAKACK or UNICAST are queuing up messages from a particular sender. OOB messages are often used internally by JGroups protocols and can be used by applications as well. For example, when JBoss Cache is in **REPL\_SYNC** mode, it uses OOB messages for the second phase of its two-phase-commit protocol.

### 28.1.2.2. TCP configuration

Alternatively, a JGroups-based cluster can also work over TCP connections. Compared with UDP, TCP generates more network traffic when the cluster size increases. TCP is fundamentally a unicast protocol. To send multicast messages, JGroups uses multiple TCP unicasts. To use TCP as a transport protocol, you should define a **TCP** element in the JGroups `config` element. Here is an example of the **TCP** element.

```
<TCP singleton_name="tcp"
      start_port="7800" end_port="7800"/>
```

The following attributes are specific to the **TCP** element:

- **start\_port** and **end\_port** define the range of TCP ports to which the server should bind. The server socket is bound to the first available port beginning with **start\_port**. If no available port is found (for example, because the ports are in use by other sockets) before the **end\_port**, the server throws an exception. If no **end\_port** is provided, or **end\_port** is lower than **start\_port**, no upper limit is applied to the port range. If **start\_port** is equal to **end\_port**, JGroups is forced to use the specified port, since **start\_port** fails if the specified port is not available. The default value is **7800**. If set to **0**, the operating system will select a port. (This will only work for **MPING** or **TCPGOSSIP** discovery protocols. **TCCPING** requires that nodes and their required ports are listed.)
- **bind\_port** in TCP acts as an alias for **start\_port**. If configured internally, it sets **start\_port**.
- **recv\_buf\_size**, **send\_buf\_size** define receive and send buffer sizes. It is good to have a large receiver buffer size, so packets are less likely to get dropped due to buffer overflow.
- **conn\_expire\_time** specifies the time (in milliseconds) after which a connection can be closed by the reaper if no traffic has been received.

- **reaper\_interval** specifies interval (in milliseconds) to run the reaper. If both values are 0, no reaping will be done. If either value is > 0, reaping will be enabled. By default, **reaper\_interval** is 0, which means no reaper.
- **sock\_conn\_timeout** specifies max time in milliseconds for a socket creation. When doing the initial discovery, and a peer hangs, do not wait forever but go on after the timeout to ping other members. Reduces chances of \*not\* finding any members at all. The default is 2000.
- **use\_send\_queues** specifies whether to use separate send queues for each connection. This prevents blocking on write if the peer hangs. The default is true.
- **external\_addr** specifies external IP address to broadcast to other group members (if different to local address). This is useful when you have use (Network Address Translation) NAT, e.g. a node on a private network, behind a firewall, but you can only route to it via an externally visible address, which is different from the local address it is bound to. Therefore, the node can be configured to broadcast its external address, while still able to bind to the local one. This avoids having to use the TUNNEL protocol, (and hence a requirement for a central gossip router) because nodes outside the firewall can still route to the node inside the firewall, but only on its external address. Without setting the **external\_addr**, the node behind the firewall will broadcast its private address to the other nodes which will not be able to route to it.
- **skip\_suspected\_members** specifies whether unicast messages should not be sent to suspected members. The default is true.
- **tcp\_nodelay** specifies TCP\_NODELAY. TCP by default nags messages, that is, conceptually, smaller messages are bundled into larger ones. If we want to invoke synchronous cluster method calls, then we need to disable nagling in addition to disabling message bundling (by setting **enable\_bundling** to false). Nagling is disabled by setting **tcp\_nodelay** to true. The default is false.



#### NOTE

All of the attributes common to all protocols discussed in the UDP protocol section also apply to TCP.

### 28.1.2.3. TUNNEL configuration

The **TUNNEL** protocol uses an external router process to send messages. The external router is a Java process that runs the `org.jgroups.stack.GossipRouter` main class. Each node has to register with the router. All messages are sent to the router and forwarded on to their destinations. The **TUNNEL** approach can be used to set up communication with nodes behind firewalls. A node can establish a TCP connection to the **GossipRouter** through the firewall (you can use port 80). This connection is also used by the router to send messages to nodes behind the firewall, as most firewalls do not permit outside hosts to initiate a TCP connection to a host inside the firewall. The **TUNNEL** configuration is defined in the **TUNNEL** element within the JGroups `<config>` element, like so:

```
<TUNNEL singleton_name="tunnel"
        router_port="12001"
        router_host="192.168.5.1"/>
```

The available attributes in the **TUNNEL** element are listed below.

- **router\_host** specifies the host on which the **GossipRouter** is running.
- **router\_port** specifies the port on which the **GossipRouter** is listening.

- **reconnect\_interval** specifies the interval of time (in milliseconds) for which **TUNNEL** will attempt to connect to the **GossipRouter** if the connection is not established. The default value is **5000**.



## NOTE

All of the attributes common to all protocols discussed in the UDP protocol section also apply to **TUNNEL**.

### 28.1.3. Discovery Protocols

When a channel on a node first connects, it must determine which other nodes are running compatible channels, and which of these nodes is currently acting as the *coordinator* (the node responsible for letting new nodes join the group). Discovery protocols are used to find active nodes in the cluster and to determine which is the coordinator. This information is then provided to the group membership protocol (GMS), which communicates with the coordinator's GMS to add the newly-connecting node to the group. (For more information about group membership protocols, see [Section 28.1.6, “Group Membership \(GMS\)”](#).)

Discovery protocols also assist merge protocols (see [Section 28.5, “Merging \(MERGE2\)”](#)) to detect cluster-split situations.

The discovery protocols sit on top of the transport protocol, so you can choose to use different discovery protocols depending on your transport protocol. These are also configured as sub-elements in the JGroups `<config>` element.

#### 28.1.3.1. PING

PING is a discovery protocol that works by either multicasting PING requests to an IP multicast address or connecting to a gossip router. As such, PING normally sits on top of the UDP or TUNNEL transport protocols. Each node responds with a packet {C, A}, where C=coordinator's address and A=own address. After timeout milliseconds or num\_initial\_members replies, the joiner determines the coordinator from the responses, and sends a JOIN request to it (handled by). If nobody responds, we assume we are the first member of a group.

Here is an example PING configuration for IP multicast.

```
<PING timeout="2000"
      num_initial_members="3"/>
```

Here is another example PING configuration for contacting a Gossip Router.

```
<PING gossip_host="localhost"
      gossip_port="1234"
      timeout="2000"
      num_initial_members="3"/>
```

The available attributes in the **PING** element are listed below.

- **timeout** specifies the maximum number of milliseconds to wait for num\_initial\_members responses. The default is 3000.
- **num\_initial\_members** specifies the minimum number of responses to wait for unless timeout has expired. The default is 2.



- **gossip\_host** specifies the host on which the GossipRouter is running.
- **gossip\_port** specifies the port on which the GossipRouter is listening on.
- **gossip\_refresh** specifies the interval (in milliseconds) for the lease from the GossipRouter. The default is 20000.
- **initial\_hosts** is a comma-separated list of addresses or ports (for example, `host1[12345], host2[23456]`) which are pinged for discovery. Default is `null`, meaning multicast discovery should be used. If **initial\_hosts** is specified, you must list all possible cluster members, not just a few well-known hosts, or **MERGE2** cluster split discovery will not work reliably.

If both **gossip\_host** and **gossip\_port** are defined, the cluster uses the GossipRouter for the initial discovery. If the **initial\_hosts** is specified, the cluster pings that static list of addresses for discovery. Otherwise, the cluster uses IP multicasting for discovery.



#### NOTE

The discovery phase returns when the **timeout** ms have elapsed or the **num\_initial\_members** responses have been received.

#### 28.1.3.2. TCPGOSSIP

The TCPGOSSIP protocol only works with a GossipRouter. It works essentially the same way as the PING protocol configuration with valid **gossip\_host** and **gossip\_port** attributes. It works on top of both UDP and TCP transport protocols. Here is an example.

```
<TCPGOSSIP timeout="2000"
  num_initial_members="3"
  initial_hosts="192.168.5.1[12000],192.168.0.2[12000]"/>
```

The available attributes in the **TCPGOSSIP** element are listed below.

- **timeout** specifies the maximum number of milliseconds to wait for **num\_initial\_members** responses. The default is 3000.
- **num\_initial\_members** specifies the minimum number of responses to wait for unless timeout has expired. The default is 2.
- **initial\_hosts** is a comma-separated list of addresses/ports (for example, `host1[12345], host2[23456]`) of **GossipRouters** to register

#### 28.1.3.3. TCPPING

The TCPPING protocol takes a set of known members and pings them for discovery. The mechanism works on top of TCP.

Here is an example of the **TCPPING** configuration element in the **JGroups config** element.

```
<TCPPING timeout="2000"
  num_initial_members="3"/
  initial_hosts="hosta[2300],hostb[3400],hostc[4500]"
```

```
max_dynamic_hosts="3"
port_range="3">
```

The available attributes in the **TCPPING** element are listed below.

- **timeout** specifies the maximum number of milliseconds to wait for `num_initial_members` responses. The default is 3000.
- **num\_initial\_members** specifies the minimum number of responses to wait for unless timeout has expired. The default is 2.
- **initial\_hosts** is a comma-separated list of addresses (for example, `host1[12345], host2[23456]`) for pinging.
- **max\_dynamic\_hosts** specifies the maximum number of hosts that can be dynamically added to the cluster (defaults to 0).

If dynamic adding of hosts is not allowed, make sure you list all cluster members in the `<initial_hosts>` attribute on all cluster members before adding the new node to the cluster, so that the nodes can be added on server start.

- **port\_range** specifies the number of consecutive ports to be probed when getting the initial membership, starting with the port specified in the `initial_hosts` parameter. Given the current values of `port_range` and `initial_hosts` above, the **TCPPING** layer will try to connect to `hosta[2300], hosta[2301], hosta[2302], hostb[3400], hostb[3401], hostb[3402], hostc[4500], hostc[4501], and hostc[4502]`. This configuration option allows for multiple possible ports on the same host to be pinged without having to spell out all possible combinations. If in your TCP protocol configuration your `end_port` is greater than your `start_port`, we recommend using a **TCPPING** `port_range` equal to the difference, to ensure a node is pinged no matter which port it is bound to within the allowed range.

#### 28.1.3.4. MPING

**MPING** uses IP multicast to discover the initial membership. Unlike the other discovery protocols, which delegate the sending and receiving of discovery messages on the network to the transport protocol, **MPING** opens its own sockets to send and receive multicast discovery messages. As a result it can be used with all transports, but it is most often used with **TCP**. **TCP** usually requires **TCPPING**, which must explicitly list all possible group members. **MPING** does not have this requirement, and is typically used where **TCP** is required for regular message transport, and UDP multicasting is allowed for discovery.

```
<MPING timeout="2000"
  num_initial_members="3"
  bind_to_all_interfaces="true"
  mcast_addr="228.8.8.8"
  mcast_port="7500"
  ip_ttl="8"/>
```

The available attributes in the **MPING** element are listed below.

- **timeout** specifies the maximum number of milliseconds to wait for any responses. The default is 3000.
- **num\_initial\_members** specifies the maximum number of responses to wait for unless timeout has expired. The default is 2..

- **bind\_addr** specifies the interface on which to send and receive multicast packets. By default JGroups uses the value of the system property `jgroups.bind_addr`, which can be set with the `-b` command line switch. See [Section 28.6, “Other Configuration Issues”](#) for more on binding JGroups sockets.
- **bind\_to\_all\_interfaces** overrides the `bind_addr` and uses all interfaces in multihome nodes.
- **mcast\_addr**, **mcast\_port**, **ip\_ttl** attributes are the same as related attributes in the UDP protocol configuration.

#### 28.1.4. Failure Detection Protocols

The failure detection protocols are used to detect failed nodes. Once a failed node is detected, a *suspect verification* phase can occur. If the node is still considered dead after this phase is complete, the cluster updates its membership view so that further messages are not sent to the failed node. The service using JGroups is informed that the node is no longer part of the cluster. Failure detection protocols are configured as sub-elements in the JGroups `<config>` element.

##### 28.1.4.1. FD

**FD** is a failure detection protocol based on 'heartbeat' messages. This protocol requires that each node periodically ping its neighbor. If the neighbor fails to respond, the calling node sends a **SUSPECT** message to the cluster. The current group coordinator can optionally verify that the suspected node is dead (**VERIFY\_SUSPECT**). If the node is still considered dead after this verification step, the coordinator updates the cluster's membership view. The following is an example of **FD** configuration:

```
<FD timeout="6000"
    max_tries="5"
    shun="true"/>
```

The available attributes in the **FD** element are listed below.

- **timeout** specifies the maximum number of milliseconds to wait for the responses to the are-you-alive messages. The default is 3000.
- **max\_tries** specifies the number of missed are-you-alive messages from a node before the node is suspected. The default is 2.
- **shun** specifies whether a failed node will be forbidden from sending messages to the group without formally rejoining. A shunned node would need to rejoin the cluster via the discovery process. JGroups allows applications to configure a channel such that, when a channel is shunned, the process of rejoining the cluster and transferring state takes place automatically. This is the default behavior of JBoss Enterprise Application Platform.



#### NOTE

Regular traffic from a node is proof of life, so heartbeat messages are only sent when no regular traffic is detected on the node for a long period of time.

##### 28.1.4.2. FD SOCK

**FD SOCK** is a failure detection protocol based on a ring of TCP sockets created between group members. Each member in a group connects to its neighbor, with the final member connecting to the first, forming a ring. Node B becomes suspected when its neighbor, Node A, detects an abnormally

closed TCP socket, presumably due to a crash in Node B. (When nodes intend to leave the group, they inform their neighbors so that they do not become suspected.)

The simplest `FD_SOCKET` configuration does not take any attribute. You can declare an empty `FD_SOCKET` element in the JGroups `<config>` element.

```
<FD_SOCKET/>
```

The attributes available to the `FD_SOCKET` element are listed below.

- `bind_addr` specifies the interface to which the server socket should be bound. By default, JGroups uses the value of the system property `jgroups.bind_addr`. This system property can be set with the `-b` command line switch. For more information about binding JGroups sockets, see [Section 28.6, “Other Configuration Issues”](#).

### 28.1.4.3. VERIFY\_SUSPECT

This protocol verifies whether a suspected member is really dead by pinging that member once again. This verification is performed by the coordinator of the cluster. The suspected member is dropped from the cluster group if confirmed to be dead. The aim of this protocol is to minimize false suspicions. Here's an example.

```
<VERIFY_SUSPECT timeout="1500"/>
```

The available attributes in the `VERIFY_SUSPECT` element are listed below.

- `timeout` specifies how long to wait for a response from the suspected member before considering it dead.

### 28.1.4.4. FD versus FD\_SOCKET

FD and `FD_SOCKET`, each taken individually, do not provide a solid failure detection layer. Let us look at the differences between these failure detection protocols to understand how they complement each other:

- *FD*
  - An overloaded machine might be slow in sending are-you-alive responses.
  - A member will be suspected when suspended in a debugger/profiler.
  - Low timeouts lead to higher probability of false suspicions and higher network traffic.
  - High timeouts will not detect and remove crashed members for some time.
- *FD\_SOCKET*:
  - Suspended in a debugger is no problem because the TCP connection is still open.
  - High load no problem either for the same reason.
  - Members will only be suspected when TCP connection breaks, so hung members will not be detected.

- o Also, a crashed switch will not be detected until the connection runs into the TCP timeout (between 2-20 minutes, depending on TCP/IP stack implementation).

A failure detection layer is intended to report real failures promptly, while avoiding false suspicions. There are two solutions:

1. By default, JGroups configures the `FD_SOCKET` socket with `KEEP_ALIVE`, which means that TCP sends a heartbeat on socket on which no traffic has been received in 2 hours. If a host crashed (or an intermediate switch or router crashed) without closing the TCP connection properly, we would detect this after 2 hours (plus a few minutes). This is of course better than never closing the connection (if `KEEP_ALIVE` is off), but may not be of much help. So, the first solution would be to lower the timeout value for `KEEP_ALIVE`. This can only be done for the entire kernel in most operating systems, so if this is lowered to 15 minutes, this will affect all TCP sockets.
2. The second solution is to combine `FD_SOCKET` and `FD`; the timeout in `FD` can be set such that it is much lower than the TCP timeout, and this can be configured individually per process. `FD_SOCKET` will already generate a suspect message if the socket was closed abnormally. However, in the case of a crashed switch or host, `FD` will make sure the socket is eventually closed and the suspect message generated. Example:

```
<FD_SOCKET/>
<FD timeout="6000" max_tries="5" shun="true"/>
<VERIFY_SUSPECT timeout="1500"/>
```

In this example, a member becomes suspected when the neighboring socket has been closed abnormally, in a process crash, for instance, since the operating system closes all sockets. However, if a host or switch crashes, the sockets will not be closed. `FD` will suspect the neighbor after sixty seconds (6000 milliseconds). Note that if this example system were stopped in a breakpoint in the debugger, the node being debugged will be suspected once the `timeout` has elapsed.

A combination of `FD` and `FD_SOCKET` provides a solid failure detection layer, which is why this technique is used across the JGroups configurations included with JBoss Enterprise Application Platform.

## 28.1.5. Reliable Delivery Protocols

Reliable delivery protocols within the JGroups stack ensure that messages are actually delivered, and delivered in the correct order (First In, First Out, or FIFO) to the destination node. The basis for reliable message delivery is positive and negative delivery acknowledgments (`ACK` and `NAK`). In `ACK` mode, the sender resends the message until acknowledgment is received from the receiver. In `NAK` mode, the receiver requests re-transmission when it discovers a gap.

### 28.1.5.1. UNICAST

The `UNICAST` protocol is used for unicast messages. It uses positive acknowledgements ( `ACK`). It is configured as a sub-element under the JGroups `config` element. If the JGroups stack is configured with the TCP transport protocol, `UNICAST` is not necessary because TCP itself guarantees FIFO delivery of unicast messages. Here is an example configuration for the `UNICAST` protocol:

```
<UNICAST timeout="300,600,1200,2400,3600"/>
```

There is only one configurable attribute in the `UNICAST` element.

- `timeout` specifies the re-transmission timeout (in milliseconds). For instance, if the timeout is 100, 200, 400, 800, the sender resends the message if it has not received an `ACK` after 100

milliseconds the first time, and the second time it waits for 200 milliseconds before re-sending, and so on. A low value for the first timeout allows for prompt re-transmission of dropped messages, but means that messages may be transmitted more than once if they have not actually been lost (that is, the message has been sent, but the ACK has not been received before the timeout). High values (1000, 2000, 3000) can improve performance if the network is tuned such that UDP datagram loss is infrequent. High values on networks with frequent losses will be harmful to performance, since later messages will not be delivered until lost messages have been re-transmitted.

### 28.1.5.2. NAKACK

The NAKACK protocol is used for multicast messages. It uses negative acknowledgements ( NAK). Under this protocol, each message is tagged with a sequence number. The receiver keeps track of the received sequence numbers and delivers the messages in order. When a gap in the series of received sequence numbers is detected, the receiver schedules a task to periodically ask the sender to re-transmit the missing message. The task is canceled if the missing message is received. NAKACK protocol is configured as the `pbcast . NAKACK` sub-element under the JGroups `<config>` element. Here is an example configuration:

```
<pbcast.NAKACK max_xmit_size="60000" use_mcast_xmit="false"
  retransmit_timeout="300,600,1200,2400,4800" gc_lag="0"
  discard_delivered_msgs="true"/>
```

The configurable attributes in the `pbcast . NAKACK` element are as follows.

- `re-transmit_timeout` specifies the series of timeouts (in milliseconds) after which re-transmission is requested if a missing message has not yet been received.
- `use_mcast_xmit` determines whether the sender should send the re-transmission to the entire cluster rather than just to the node requesting it. This is useful when the *sender's* network layer tends to drop packets, avoiding the need to individually re-transmit to each node.
- `max_xmit_size` specifies the maximum size (in bytes) for a bundled re-transmission, if multiple messages are reported missing.
- `discard_delivered_msgs` specifies whether to discard delivered messages on the receiver nodes. By default, nodes save delivered messages so any node can re-transmit a lost message in case the original sender has crashed or left the group. However, if we only ask the sender to resend its messages, we can enable this option and discard delivered messages.
- `gc_lag` specifies the number of messages to keep in memory for re-transmission, even after the periodic cleanup protocol (see [Section 28.4, “Distributed Garbage Collection \(STABLE\)”](#)) indicates all peers have received the message. The default value is 20.

### 28.1.6. Group Membership (GMS)

The group membership service (GMS) protocol in the JGroups stack maintains a list of active nodes. It handles the requests to join and leave the cluster. It also handles the SUSPECT messages sent by failure detection protocols. All nodes in the cluster, as well as any interested services like JBoss Cache or HAPartition, are notified if the group membership changes. The group membership service is configured in the `pbcast . GMS` sub-element under the JGroups `config` element. Here is an example configuration.

```
<pbcast.GMS print_local_addr="true"
  join_timeout="3000"
```

```

join_retry_timeout="2000"
shun="true"
view_bundling="true"/>

```

The configurable attributes in the `pbcast . GMS` element are as follows.

- `join_timeout` specifies the maximum number of milliseconds to wait for a new node JOIN request to succeed. Retry afterwards.
- `join_retry_timeout` specifies the number of milliseconds to wait after a failed JOIN before trying again.
- `print_local_addr` specifies whether to dump the node's own address to the standard output when started.
- `shun` specifies whether a node should shun (that is, disconnect) itself if it receives a cluster view in which it is not a member node.
- `disable_initial_coord` specifies whether to prevent this node from becoming the cluster coordinator during the initial connection of the channel. This flag does not prevent a node becoming the coordinator after the initial channel connection, if the current coordinator leaves the group.
- `view_bundling` specifies whether multiple JOIN or LEAVE requests arriving at the same time are bundled and handled together at the same time, resulting in only one new view that incorporates all changes. This is more efficient than handling each request separately.

### 28.1.7. Flow Control (FC)

The flow control (FC) protocol tries to adapt the data sending rate to the data receipt rate among nodes. If a sender node is too fast, it might overwhelm the receiver node and result in out-of-memory conditions or dropped packets that have to be re-transmitted. In JGroups, flow control is implemented via a credit-based system. The sender and receiver nodes have the same number of credits (bytes) to start with. The sender subtracts credits by the number of bytes in messages it sends. The receiver accumulates credits for the bytes in the messages it receives. When the sender's credit drops to a threshold, the receivers send some credit to the sender. If the sender's credit is used up, the sender blocks until it receives credits from the receiver. The flow control protocol is configured in the `FC` sub-element under the JGroups `config` element. Here is an example configuration.

```

<FC max_credits="2000000"
min_threshold="0.10"
ignore_synchronous_response="true"/>

```

The configurable attributes in the `FC` element are as follows.

- `max_credits` specifies the maximum number of credits (in bytes). This value should be smaller than the JVM heap size.
- `min_credits` specifies the minimum number of bytes that must be received before the receiver will send more credits to the sender.
- `min_threshold` specifies the percentage of the `max_credits` that should be used to calculate `min_credits`. Setting this overrides the `min_credits` attribute.
- `ignore_synchronous_response` specifies whether threads that have carried messages up to the application should be allowed to carry outgoing messages back down through FC without

blocking for credits. *Synchronous response* refers to the fact that these messages are generally responses to incoming RPC-type messages. Forbidding JGroups threads to carry messages up to block in FC can help prevent certain deadlock scenarios, so we recommend setting this to **true**.



## NOTE

FC is required for group communication where group messages must be sent at the highest speed that the slowest receiver can handle. For example, say we have a cluster comprised of nodes A, B, C and D. D is slow (perhaps overloaded), while the rest are fast. When A sends a group message, it does so via TCP connections: A-A (theoretically), A-B, A-C and A-D.

Say A sends 100 million messages to the cluster. TCP's flow control applies to A-B, A-C and A-D individually, but not to A-BCD as a group. Therefore, A, B and C will receive the 100 million messages, but D will receive only 1 million. (This is also why **NAKACK** is required, even though TCP handles its own re-transmission.)

JGroups must buffer all messages in memory in case an original sender *S* dies and a node requests re-transmission of a message sent by *S*. Since all members buffer all messages that they receive, stable messages (messages seen by every node) must sometimes be purged. (The purging process is managed by the **STABLE** protocol. For more information, see [Section 28.4, "Distributed Garbage Collection \(STABLE\)"](#).)

In the above case, the slow node D will prevent the group from purging messages above 1M, so every member will buffer 99M messages ! This in most cases leads to OOM exceptions. Note that - although the sliding window protocol in TCP will cause writes to block if the window is full - we assume in the above case that this is still much faster for A-B and A-C than for A-D.

So, in summary, even with TCP we need to FC to ensure we send messages at a rate the slowest receiver (D) can handle.



**NOTE**

This depends on how the application uses the JGroups channel. Referring to the example above, if there was something about the application that would naturally cause A to slow down its rate of sending because D was not keeping up, then FC would not be needed.

A good example of such an application is one that uses JGroups to make synchronous group RPC calls. By synchronous, we mean the thread that makes the call blocks waiting for responses from all the members of the group. In that kind of application, the threads on A that are making calls would block waiting for responses from D, thus naturally slowing the overall rate of calls.

A JBoss Cache cluster configured for REPL\_SYNC is a good example of an application that makes synchronous group RPC calls. If a channel is only used for a cache configured for REPL\_SYNC, we recommend you remove FC from its protocol stack.

And, of course, if your cluster only consists of two nodes, including FC in a TCP-based protocol stack is unnecessary. There is no group beyond the single peer-to-peer relationship, and TCP's internal flow control will handle that just fine.

Another case where FC may not be needed is for a channel used by a JBoss Cache configured for buddy replication and a single buddy. Such a channel will in many respects act like a two node cluster, where messages are only exchanged with one other node, the buddy. (There may be other messages related to data gravitation that go to all members, but in a properly engineered buddy replication use case these should be infrequent. But if you remove FC be sure to load test your application.)

## 28.2. FRAGMENTATION (FRAG2)

This protocol fragments messages that are larger than a certain size, and reassembles them at the receiver's side. It works for both unicast and multicast messages. It is configured with the FRAG2 sub-element in the JGroups `config` element. Here is an example configuration:

```
<FRAG2 frag_size="60000"/>
```

The configurable attributes in the FRAG2 element are as follows.

- **frag\_size** specifies the maximum message size (in bytes) before fragmentation occurs. Messages larger than this size are fragmented. For stacks that use the UDP transport, this value must be lower than 64 kilobytes (the maximum UDP datagram size). For TCP-based stacks, it must be lower than the value of `max_credits` in the FC protocol.

**NOTE**

TCP protocol already provides fragmentation, but a JGroups fragmentation protocol is still required if FC is used. The reason for this is that if you send a message larger than `FC.max_credits`, the FC protocol will block forever. So, `frag_size` within FRAG2 must always be set to a value lower than that of `FC.max_credits`.

## 28.3. STATE TRANSFER

The state transfer service transfers the state from an existing node (i.e., the cluster coordinator) to a newly joining node. It is configured in the `pbcast.STATE_TRANSFER` sub-element under the JGroups `Config` element. It does not have any configurable attribute. Here is an example configuration.

```
<pbcast.STATE_TRANSFER/>
```

## 28.4. DISTRIBUTED GARBAGE COLLECTION (STABLE)

In a JGroups cluster, all nodes must store all messages received for potential re-transmission in case of a failure. However, if we store all messages forever, we will run out of memory. The distributed garbage collection service periodically purges messages that have been seen by all nodes, removing them from the memory in each node. The distributed garbage collection service is configured in the `pbcast.STABLE` sub-element under the JGroups `config` element. Here is an example configuration.

```
<pbcast.STABLE stability_delay="1000"
  desired_avg_gossip="5000"
  max_bytes="400000"/>
```

The configurable attributes in the `pbcast.STABLE` element are as follows.

- `desired_avg_gossip` specifies intervals (in milliseconds) of garbage collection runs. Set this to 0 to disable interval-based garbage collection.
- `max_bytes` specifies the maximum number of bytes received before the cluster triggers a garbage collection run. Set to 0 to disable garbage collection based on the bytes received.
- `stability_delay` specifies the maximum time period (in milliseconds) of a random delay introduced before a node sends its `STABILITY` message at the end of a garbage collection run. The delay gives other nodes concurrently running a `STABLE` task a chance to send first. If used together with `max_bytes`, this attribute should be set to a small number.

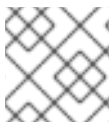

### NOTE

Set the `max_bytes` attribute when you have a high traffic cluster.

## 28.5. MERGING (MERGE2)

When a network error occurs, the cluster might be partitioned into several different partitions. JGroups has a MERGE service that allows the coordinators in partitions to communicate with each other and form a single cluster back again. The merging service is configured in the `MERGE2` sub-element under the JGroups `Config` element. Here is an example configuration.

```
<MERGE2 max_interval="10000"
  min_interval="2000"/>
```

The configurable attributes in the `MERGE2` element are as follows.

- `max_interval` specifies the maximum number of milliseconds to wait before sending a MERGE message.
- `min_interval` specifies the minimum number of milliseconds to wait before sending a MERGE message.

JGroups chooses a random value between `min_interval` and `max_interval` to periodically send the MERGE message.



#### NOTE

The application state maintained by the application using a channel is not merged by JGroups during a merge. This must be done by the application.



#### NOTE

If `MERGE2` is used in conjunction with `TCCPING`, the `initial_hosts` attribute must contain all the nodes that could potentially be merged back, in order for the merge process to work properly. Otherwise, the merge process may not detect all sub-groups, and may miss those comprised solely of unlisted members.

## 28.6. OTHER CONFIGURATION ISSUES

### 28.6.1. Binding JGroups Channels to a Particular Interface

In the Transport Protocols section above, we briefly touched on how the interface to which JGroups will bind sockets is configured. Let us get into this topic in more depth:

First, it is important to understand that the value set in any `bind_addr` element in an XML configuration file will be ignored by JGroups if it finds that the system property `jgroups.bind_addr` (or a deprecated earlier name for the same thing, `bind.address`) has been set. The system property has a higher priority level than the XML property. If JBoss Enterprise Application Platform is started with the `-b` (or `--host`) switch, the application server will set `jgroups.bind_addr` to the specified value. If `-b` is not set, the application server will bind most services to `localhost` by default.

So, what are *best practices* for managing how JGroups binds to interfaces?

- Binding JGroups to the same interface as other services. Simple, just use `-b`:

```
./run.sh -b 192.168.1.100 -c production
```

- Binding services (e.g., JBoss Web) to one interface, but use a different one for JGroups:

```
./run.sh -b 10.0.0.100 -Djgroups.bind_addr=192.168.1.100 -c
production
```

Specifically setting the system property overrides the `-b` value. This is a common usage pattern; put client traffic on one network, with intra-cluster traffic on another.

- Binding services (e.g., JBoss Web) to all interfaces. This can be done like this:

```
./run.sh -b 0.0.0.0 -c production
```

However, doing this will not cause JGroups to bind to all interfaces! Instead, JGroups will bind to the machine's default interface. See the Transport Protocols section for how to tell JGroups to receive or send on all interfaces, if that is what you really want.

- Binding services (e.g., JBoss Web) to all interfaces, but specify the JGroups interface:

```
./run.sh -b 0.0.0.0 -Djgroups.bind_addr=192.168.1.100 -c production
```

Again, specifically setting the system property overrides the **-b** value.

- Using different interfaces for different channels:

```
./run.sh -b 10.0.0.100 -Djgroups.ignore.bind_addr=true -c production
```

This setting tells JGroups to ignore the `jgroups.bind_addr` system property, and instead use whatever is specified in XML. You would need to edit the various XML configuration files to set the various `bind_addr` attributes to the desired interfaces.

## 28.6.2. Isolating JGroups Channels

Within JBoss Enterprise Application Platform, there are a number of services that independently create JGroups channels – possibly multiple different JBoss Cache services (used for `HttpSession` replication, EJB3 stateful session bean replication and EJB3 entity replication), two JBoss Messaging channels, and `HAPartition`, the general purpose clustering service that underlies most other JBossHA services.

It is critical that these channels only communicate with their intended peers; not with the channels used by other services and not with channels for the same service opened on machines not meant to be part of the group. Nodes improperly communicating with each other is one of the most common issues users have with JBoss Enterprise Application Platform clustering.

Whom a JGroups channel will communicate with is defined by its group name and, for UDP-based channels, its multicast address and port. Isolating a JGroups channel means ensuring that different channels use different values for the group name, the multicast address and, in some cases, the multicast port.

### 28.6.2.1. Isolating Sets of JBoss Enterprise Application Platform Instances from Each Other

This section addresses the issue of having multiple independent clusters running within the same environment. For example, you might have a production cluster, a staging cluster, and a QA cluster, or multiple clusters in a QA test lab or development team environment.

To isolate JGroups clusters from other clusters on the network, you must:

- Make sure the channels in the various clusters use different group names. This can be controlled with the command line arguments used to start JBoss Enterprise Application Platform; see [Section 28.6.2.2.1, “Changing the Group Name”](#) for more information.
- Make sure the channels in the various clusters use different multicast addresses. This is also easy to control with the command line arguments used to start JBoss.
- If you are not running on Linux, Windows, Solaris or HP-UX, you may also need to ensure that the channels in each cluster use different multicast ports. This is more difficult than using different group names, although it can still be controlled from the command line. See [Section 28.6.2.2.3, “Changing the Multicast Port”](#). Note that using different ports should not be necessary if your servers are running on Linux, Windows, Solaris or HP-UX.

### 28.6.2.2. Isolating Channels for Different Services on the Same Set of JBoss Enterprise Application Platform Instances

This section addresses the usual case: a cluster of three machines, each of which has, for example, an HAPartition deployed alongside JBoss Cache for web session clustering. The HAPartition channels should not communicate with the JBoss Cache channels. Ensuring proper isolation of these channels is straightforward, and is usually handled by the application server without any alterations on the part of the user.

To isolate channels for different services from each other on the same set of application server instances, each channel must have its own group name. The configurations that ship with JBoss Enterprise Application Platform ensure that this is the case. However, if you create a custom service that uses JGroups directly, you must use a unique group name. If you create a custom JBoss Cache configuration, ensure that you provide a unique value in the `clusterName` configuration property.

In releases prior to JBoss Enterprise Application Platform 5, different channels running in the same application server also had to use unique multicast ports. With the JGroups shared transport introduced in JBoss Enterprise Application Platform 5 (see [Section 21.1.2, “The JGroups Shared Transport”](#)), it is now common for multiple channels to use the same transport protocol and its sockets. This makes configuration easier, which is one of the main benefits of the shared transport. However, if you decide to create your own custom JGroups protocol stack configuration, be sure to configure its transport protocols with a multicast port that is different from the ports used in other protocol stacks.

#### 28.6.2.2.1. Changing the Group Name

The group name for a JGroups channel is configured via the service that starts the channel. For all the standard clustered services, we make it easy for you to create unique groups names by simply using the `-g` (or `--partition`) switch when starting JBoss:

```
./run.sh -g QAPartition -b 192.168.1.100 -c production
```

This switch sets the `jboss.partition.name` system property, which is used as a component in the configuration of the group name in all the standard clustering configuration files. For example,

```
<property name="clusterName">${jboss.partition.name:DefaultPartition}-SFSBCache</property>
```

#### 28.6.2.2.2. Changing the multicast address and port

The `-u` (or `--udp`) command line switch may be used to control the multicast address used by the JGroups channels opened by all standard JBoss Enterprise Application Platform services.

```
/run.sh -u 230.1.2.3 -g QAPartition -b 192.168.1.100 -c production
```

This switch sets the `jboss.partition.udpGroup` system property, which is referenced in all of the standard protocol stack configurations in JBoss Enterprise Application Platform:

```
<UDP mcast_addr="${jboss.partition.udpGroup:228.1.2.3}" ....
```



#### NOTE

If channels with different group names share the same multicast address and port, the lower level JGroups protocols in each channel will see, process and eventually discard messages intended for the other group. This will at a minimum hurt performance and can lead to anomalous behavior.

### 28.6.2.2.3. Changing the Multicast Port

On some operating systems (Mac OS X for example), using different `-g` and `-u` values is not sufficient to isolate clusters; the channels running in the different clusters must also use different multicast ports. Unfortunately, setting the multicast ports is not as simple as `-g` and `-u`. By default, a JBoss Enterprise Application Platform instance running the `production` configuration will use up to two different instances of the JGroups UDP transport protocol, and will therefore open two multicast sockets. You can control the ports those sockets use by using system properties on the command line. For example,

```
/run.sh -u 230.1.2.3 -g QAPartition -b 192.168.1.100 -c production \\  
-Djboss.jgroups.udp.mcast_port=12345 -  
Djboss.messaging.datachanneludpport=23456
```

The `jboss.messaging.datachanneludpport` property controls the multicast port used by the `MPING` protocol in JBoss Messaging's `DATA` channel. The `jboss.jgroups.udp.mcast_port` property controls the multicast port used by the UDP transport protocol shared by all other clustered services.

The set of JGroups protocol stack configurations included in the `<JBOSS_HOME>/server/production/deploy/cluster/jgroups-channelfactory.sar/META-INF/jgroups-channelfactory-stacks.xml` file includes a number of other example protocol stack configurations that the standard JBoss Enterprise Application Platform distribution does not actually use. Those configurations also use system properties to set any multicast ports. So, if you reconfigure a JBoss Enterprise Application Platform service to use one of those protocol stack configurations, use the appropriate system property to control the port from the command line.



#### NOTE

It should be sufficient to just change the address, but unfortunately the handling of multicast sockets is one area where the JVM fails to hide operating system behavior differences from the application. The `java.net.MulticastSocket` class provides different overloaded constructors. On some operating systems, if you use one constructor variant, packets addressed to a particular multicast port are delivered to all listeners on that port, regardless of the multicast address on which they are listening. We refer to this as the *promiscuous traffic* problem. On most operating systems that exhibit the promiscuous traffic problem (Linux, Solaris and HP-UX) JGroups can use a different constructor variant that avoids the problem. However, on some operating systems with the promiscuous traffic problem (Mac OS X), multicast does not work properly if the other constructor variant is used. So, on these operating systems the recommendation is to configure different multicast ports for different clusters.

### 28.6.2.3. Improving UDP Performance by Configuring OS UDP Buffer Limits

By default, the JGroups channels in JBoss Enterprise Application Platform use the UDP transport protocol to take advantage of IP multicast. However, one disadvantage of UDP is it does not come with the reliable delivery guarantees provided by TCP. The protocols discussed in [Section 28.1.5, “Reliable Delivery Protocols”](#) allow JGroups to guarantee delivery of UDP messages, but those protocols are implemented in Java, not at the operating system network layer. For peak performance from a UDP-based JGroups channel it is important to limit the need for JGroups to re-transmit messages by limiting UDP datagram loss.

One of the most common causes of lost UDP datagrams is an undersized receive buffer on the socket. The UDP protocol's `mcast_recv_buf_size` and `ucast_recv_buf_size` configuration attributes

are used to specify the amount of receive buffer JGroups *requests* from the operating system, but the actual size of the buffer the operating system provides is limited by operating system-level maximums. These maximums are often very low:

**Table 28.1. Default Max UDP Buffer Sizes**

Operating System	Default Max UDP Buffer (in bytes)
Linux	131071
Windows	No known limit
Solaris	262144
FreeBSD, Darwin	262144
AIX	1048576

The command used to increase the above limits is operating system-specific. The table below shows the command required to increase the maximum buffer to 25 megabytes. In all cases, root privileges are required:

**Table 28.2. Commands to Change Max UDP Buffer Sizes**

Operating System	Command
Linux	<code>sysctl -w net.core.rmem_max=26214400</code>
Solaris	<code>ndd -set /dev/udp udp_max_buf 26214400</code>
FreeBSD, Darwin	<code>sysctl -w kern.ipc.maxsockbuf=26214400</code>
AIX	<code>no -o sb_max=8388608</code> (AIX will only allow 1 megabyte, 4 megabytes or 8 megabytes).

### 28.6.3. JGroups Troubleshooting

#### 28.6.3.1. Nodes do not form a cluster

Make sure your machine is set up correctly for IP multicast. There are 2 test programs that can be used to detect this: `McastReceiverTest` and `McastSenderTest`. Go to the `<JBOSS_HOME>/server/production/lib` directory and start `McastReceiverTest`, for example:

```
[lib]$ java -cp jgroups.jar org.jgroups.tests.McastReceiverTest -
mcast_addr 224.10.10.10 -port 5555
```

Then in another window start `McastSenderTest`:

```
[lib]$ java -cp jgroups.jar org.jgroups.tests.McastSenderTest -mcast_addr  
224.10.10.10 -port 5555
```

If you want to bind to a specific network interface card (NIC), use `-bind_addr 192.168.0.2`, where `192.168.0.2` is the IP address of the NIC to which you want to bind. Use this parameter in both the sender and the receiver.

You should be able to type in the `McastSenderTest` window and see the output in the `McastReceiverTest` window. If not, try to use `-ttl 32` in the sender. If this still fails, consult a system administrator to help you setup IP multicast correctly, and ask the admin to make sure that multicast will work on the interface you have chosen or, if the machines have multiple interfaces, ask to be told the correct interface. Once you know multicast is working properly on each machine in your cluster, you can repeat the above test to test the network, putting the sender on one machine and the receiver on another.

### 28.6.3.2. Causes of missing heartbeats in FD

Sometimes a member is suspected by FD because a heartbeat ack has not been received for some time `T` (defined by `timeout` and `max_tries`). This can have multiple reasons, e.g. in a cluster of A,B,C,D; C can be suspected if (note that A pings B, B pings C, C pings D and D pings A):

- B or C are running at 100% CPU for more than `T` seconds. So even if C sends a heartbeat ack to B, B may not be able to process it because it is at 100%
- B or C are garbage collecting, same as above.
- A combination of the 2 cases above
- The network loses packets. This usually happens when there is a lot of traffic on the network, and the switch starts dropping packets (usually broadcasts first, then IP multicasts, TCP packets last).
- B or C are processing a callback. Let us say C received a remote method call over its channel and takes `T+1` seconds to process it. During this time, C will not process any other messages, including heartbeats, and therefore B will not receive the heartbeat ack and will suspect C.



## CHAPTER 29. JBOSS CACHE CONFIGURATION AND DEPLOYMENT

JBoss Cache provides the underlying distributed caching support used by many of the standard clustered services in a JBoss Enterprise Application Platform cluster. You can also deploy JBoss Cache in your own application to handle custom caching requirements. In this chapter we provide some background on the main configuration options available with JBoss Cache, with an emphasis on how those options relate to the JBoss Cache usage by the standard clustered services the Enterprise Application Platform provides. We then discuss the different options available for deploying a custom cache in the Enterprise Application Platform.

Users considering deploying JBoss Cache for direct use by their own application are strongly encouraged to read the JBoss Cache documentation available at the <https://access.redhat.com/knowledge/docs/>.

See also [Section 21.2, “Distributed Caching with JBoss Cache”](#) for information on how the standard JBoss Enterprise Application Platform clustered services use JBoss Cache.

### 29.1. KEY JBOSS CACHE CONFIGURATION OPTIONS

JBoss Enterprise Application Platform ships with a reasonable set of default JBoss Cache configurations that are suitable for the standard clustered service use cases (e.g. web session replication or JPA/Hibernate caching). Most applications that involve the standard clustered services just work out of the box with the default configurations. You only need to tweak them when you are deploying an application that has special network or performance requirements. In this section we provide a brief overview of some of the key configuration choices. This is by no means a complete discussion; for full details users interested in moving beyond the default configurations are encouraged to read the JBoss Cache documentation available at <https://access.redhat.com/knowledge/docs/>.

Most JBoss Cache configuration examples in this section use the JBoss Microcontainer schema for building up an `org.jboss.cache.config.Configuration` object graph from XML. JBoss Cache has its own custom XML schema, but the standard JBoss Enterprise Application Platform CacheManager service uses the JBoss Microcontainer schema to be consistent with most other internal Enterprise Application Platform services.

Before getting into the key configuration options, let us have a look at the most likely place that a user would encounter them.

#### 29.1.1. Editing the CacheManager Configuration

As discussed in [Section 21.2.1, “The JBoss Enterprise Application Platform CacheManager Service”](#), the standard JBoss Enterprise Application Platform clustered services use the CacheManager service as a factory for JBoss Cache instances. So, cache configuration changes are likely to involve edits to the CacheManager service.



#### NOTE

Users can also use the CacheManager as a factory for custom caches used by directly by their own applications; see [Section 29.2.1, “Deployment Via the CacheManager Service”](#).

The CacheManager is configured via the `<JBOSS_HOME>/server/<PROFILE>/deploy/cluster/jboss-cache-manager.sar/META-`

**INF/jboss-cache-manager-jboss-beans.xml** file. The element most likely to be edited is the "CacheConfigurationRegistry" bean, which maintains a registry of all the named JBC configurations the CacheManager knows about. Most edits to this file would involve adding a new JBoss Cache configuration or changing a property of an existing one.

The following is a redacted version of the "CacheConfigurationRegistry" bean configuration:

```
<bean name="CacheConfigurationRegistry"
class="org.jboss.ha.cachemanager.DependencyInjectedConfigurationRegistry">
    <!-- If users wish to add configs using a more familiar JBC config
format
        they can add them to a cache-configs.xml file specified by this
property.
        However, use of the microcontainer format used below is
recommended.
        <property name="configResource">META-INF/jboss-cache-
configs.xml</property>
        -->
    <!-- The configurations. A Map<String name, Configuration config> --
>
    <property name="newConfigurations">
        <map keyClass="java.lang.String"
valueClass="org.jboss.cache.config.Configuration">

        <!-- The standard configurations follow. You can add your own and/or
edit these. -->

        <!-- Standard cache used for web sessions -->
        <entry><key>standard-session-cache</key>
        <value>
            <bean name="StandardSessionCacheConfig"
class="org.jboss.cache.config.Configuration">

                <!-- Provides batching functionality for caches that do not want
to
                    interact with regular JTA Transactions -->
                <property name="transactionManagerLookupClass">
                    org.jboss.cache.transaction.BatchModeTransactionManagerLookup
                </property>

                <!-- Name of cluster. Needs to be the same for all members -->
                <property
name="clusterName">${jboss.partition.name:DefaultPartition}-
SessionCache</property>
                <!-- Use a UDP (multicast) based stack. Need JGroups flow control
(FC)
                    because we are using asynchronous replication. -->
                <property
name="multiplexerStack">${jboss.default.jgroups.stack:udp}</property>
                <property name="fetchInMemoryState">true</property>

                <property name="nodeLockingScheme">PESSIMISTIC</property>
                <property name="isolationLevel">REPEATABLE_READ</property>
            </bean>
        </value>
        </entry>
    </map>
    </property>
</bean>
```

```

        <property name="cacheMode">REPL_ASYNC</property>
        .... more details of the standard-session-cache configuration
    </bean>
</value>
</entry>

<!-- Appropriate for web sessions with FIELD granularity -->
<entry><key>field-granularity-session-cache</key>
<value>

    <bean name="FieldSessionCacheConfig"
class="org.jboss.cache.config.Configuration">
        .... details of the field-granularity-standard-session-cache
configuration
    </bean>

</value>

</entry>

... entry elements for the other configurations

</map>
</property>
</bean>

```

The actual JBoss Cache configurations are specified using the JBoss Microcontainer's schema rather than one of the standard JBoss Cache configuration formats. When JBoss Cache parses one of its standard configuration formats, it creates a Java Bean of type `org.jboss.cache.config.Configuration` with a tree of child Java Beans for some of the more complex sub-configurations (i.e. cache loading, eviction, buddy replication). Rather than delegating this task of XML parsing/Java Bean creation to JBC, we let the Enterprise Application Platform's microcontainer do it directly. This has the advantage of making the microcontainer aware of the configuration beans, which in later Enterprise Application Platform 5.x releases will be helpful in allowing external management tools to manage the JBC configurations.

The configuration format should be fairly self-explanatory if you look at the standard configurations the Enterprise Application Platform ships; they include all the major elements. The types and properties of the various java beans that make up a JBoss Cache configuration can be seen in the JBoss Cache Javadocs. Here is a fairly complete example:

```

<bean name="StandardSFSBCacheConfig"
class="org.jboss.cache.config.Configuration">

    <!-- No transaction manager lookup -->

    <!-- Name of cluster. Needs to be the same for all members -->
    <property name="clusterName">${jboss.partition.name:DefaultPartition}-
SFSBCache</property>
    <!-- Use a UDP (multicast) based stack. Need JGroups flow control (FC)
because we are using asynchronous replication. -->
    <property
name="multiplexerStack">${jboss.default.jgroups.stack:udp}</property>
    <property name="fetchInMemoryState">true</property>

```

```

<property name="nodeLockingScheme">PESSIMISTIC</property>
<property name="isolationLevel">REPEATABLE_READ</property>
<property name="cacheMode">REPL_ASYNC</property>

<property name="useLockStriping">>false</property>

<!-- Number of milliseconds to wait until all responses for a
synchronous call have been received. Make this longer
than lockAcquisitionTimeout.-->
<property name="syncReplTimeout">17500</property>
<!-- Max number of milliseconds to wait for a lock acquisition -->
<property name="lockAcquisitionTimeout">15000</property>
<!-- The max amount of time (in milliseconds) we wait until the
state (ie. the contents of the cache) are retrieved from
existing members at startup. -->
<property name="stateRetrievalTimeout">60000</property>

<!--
SFSBs use region-based marshalling to provide for partial state
transfer during deployment/undeployment.
-->
<property name="useRegionBasedMarshalling">>false</property>
<!-- Must match the value of "useRegionBasedMarshalling" -->
<property name="inactiveOnStartup">>false</property>

<!-- Disable asynchronous RPC marshalling/sending -->
<property name="serializationExecutorPoolSize">0</property>
<!-- We have no asynchronous notification listeners -->
<property name="listenerAsyncPoolSize">0</property>

<property name="exposeManagementStatistics">>true</property>

<property name="buddyReplicationConfig">
  <bean class="org.jboss.cache.config.BuddyReplicationConfig">

    <!-- Just set to true to turn on buddy replication -->
    <property name="enabled">>false</property>

    <!-- A way to specify a preferred replication group. We try
and pick a buddy who shares the same pool name (falling
back to other buddies if not available). -->
    <property name="buddyPoolName">default</property>

    <property name="buddyCommunicationTimeout">17500</property>

    <!-- Do not change these -->
    <property name="autoDataGravitation">>false</property>
    <property name="dataGravitationRemoveOnFind">>true</property>
    <property name="dataGravitationSearchBackupTrees">>true</property>

    <property name="buddyLocatorConfig">
      <bean
class="org.jboss.cache.buddyreplication.NextMemberBuddyLocatorConfig">
        <!-- The number of backup nodes we maintain -->
        <property name="numBuddies">1</property>
        <!-- Means that each node will *try* to select a buddy on

```

```

        a different physical host. If not able to do so
        though, it will fall back to colocated nodes. -->
        <property name="ignoreColocatedBuddies">true</property>
    </bean>
</property>
</bean>
</property>
<property name="cacheLoaderConfig">
    <bean class="org.jboss.cache.config.CacheLoaderConfig">
        <!-- Do not change these -->
        <property name="passivation">true</property>
        <property name="shared">false</property>

        <property name="individualCacheLoaderConfigs">
            <list>
                <bean
class="org.jboss.cache.loader.FileCacheLoaderConfig">
                    <!-- Where passivated sessions are stored -->
                    <property
name="location">${jboss.server.data.dir}${/}sfsb</property>
                    <!-- Do not change these -->
                    <property name="async">false</property>
                    <property
name="fetchPersistentState">true</property>
                    <property name="purgeOnStartup">true</property>
                    <property
name="ignoreModifications">false</property>
                    <property
name="checkCharacterPortability">false</property>
                </bean>
            </list>
        </property>
    </bean>
</property>

<!-- EJBs use JBoss Cache eviction -->
<property name="evictionConfig">
    <bean class="org.jboss.cache.config.EvictionConfig">
        <property name="wakeupInterval">5000</property>
        <!-- Overall default -->
        <property name="defaultEvictionRegionConfig">
            <bean class="org.jboss.cache.config.EvictionRegionConfig">
                <property name="regionName"/></property>
                <property name="evictionAlgorithmConfig">
                    <bean
class="org.jboss.cache.eviction.NullEvictionAlgorithmConfig"/>
                </property>
            </bean>
        </property>
        <!-- EJB3 integration code will programatically create
        other regions as beans are deployed -->
    </bean>
</property>
</bean>

```

Basically, the XML specifies the creation of an `org.jboss.cache.config.Configuration` java

bean and the setting of a number of properties on that bean. Most of the properties are of simple types, but some, such as `buddyReplicationConfig` and `cacheLoaderConfig` take various types java beans as their values.

Next we will look at some of the key configuration options.

### 29.1.2. Cache Mode

JBoss Cache's `cacheMode` configuration attribute combines into a single property two related aspects:

#### Handling of Cluster Updates

This controls how a cache instance on one node should notify the rest of the cluster when it makes changes in its local state. There are three options:

- **Synchronous** means the cache instance sends a message to its peers notifying them of the change(s) and before returning waits for them to acknowledge that they have applied the same changes. If the changes are made as part of a JTA transaction, this is done as part of a two-phase commit process during transaction commit. Any locks are held until this acknowledgment is received. Waiting for acknowledgement from all nodes adds delays, but it ensures consistency around the cluster. Synchronous mode is needed when all the nodes in the cluster may access the cached data resulting in a high need for consistency.
- **Asynchronous** means the cache instance sends a message to its peers notifying them of the change(s) and then immediately returns, without any acknowledgement that they have applied the same changes. It *does not* mean sending the message is handled by some other thread besides the one that changed the cache content; the thread that makes the change still spends some time dealing with sending messages to the cluster, just not as much as with synchronous communication. Asynchronous mode is most useful for cases like session replication, where the cache doing the sending expects to be the only one that accesses the data and the cluster messages are used to provide backup copies in case of failure of the sending node. Asynchronous messaging adds a small risk that a later user request that fails over to another node may see out-of-date state, but for many session-type applications this risk is acceptable given the major performance benefits asynchronous mode has over synchronous mode.
- **Local** means the cache instance does not send a message at all. A JGroups channel is not even used by the cache. JBoss Cache has many useful features besides its clustering capabilities and is a very useful caching library even when not used in a cluster. Also, even in a cluster, some cached data does not need to be kept consistent around the cluster, in which case Local mode will improve performance. Caching of JPA/Hibernate query result sets is an example of this; Hibernate's second level caching logic uses a separate mechanism to invalidate stale query result sets from the second level cache, so JBoss Cache does not need to send messages around the cluster for a query result set cache.

#### Replication vs. Invalidation

This aspect deals with the content of messages sent around the cluster when a cache changes its local state, i.e. what should the other caches in the cluster do to reflect the change:

- **Replication** means the other nodes should update their state to reflect the new state on the sending node. This means the sending node needs to include the changed state, increasing the cost of the message. Replication is necessary if the other nodes have no other way to obtain the state.
- **Invalidation** means the other nodes should remove the changed state from their local state. Invalidation reduces the cost of the cluster update messages, since only the cache key of the changed state needs to be transmitted, not the state itself. However, it is only an option if the

removed state can be retrieved from another source. It is an excellent option for a clustered JPA/Hibernate entity cache, since the cached state can be re-read from the database.

These two aspects combine to form 5 valid values for the `cacheMode` configuration attribute:

- **LOCAL** means no cluster messages are needed.
- **REPL\_SYNC** means synchronous replication messages are sent.
- **REPL\_ASYNC** means asynchronous replication messages are sent.
- **INVALIDATION\_SYNC** means synchronous invalidation messages are sent.
- **INVALIDATION\_ASYNC** means asynchronous invalidation messages are sent.

### 29.1.3. Transaction Handling

JBoss Cache integrates with JTA transaction managers to allow transactional access to the cache. When JBoss Cache detects the presence of a transaction, any locks are held for the life of the transaction, changes made to the cache will be reverted if the transaction rolls back, and any cluster-wide messages sent to inform other nodes of changes are deferred and sent in a batch as part of transaction commit (reducing chattiness).

Integration with a transaction manager is accomplished by setting the `transactionManagerLookupClass` configuration attribute; this specifies the fully qualified class name of a class JBoss Cache can use to find the local transaction manager. Inside JBoss Enterprise Application Platform, this attribute would have one of two values:

- **`org.jboss.cache.transaction.JBossTransactionManagerLookup`**

This finds the standard transaction manager running in the application server. Use this for any custom caches you deploy where you want caching to participate in any JTA transactions.

- **`org.jboss.cache.transaction.BatchModeTransactionManagerLookup`**

This is used in the cache configurations used for web session and EJB SFSB caching. It specifies a simple mock `TransactionManager` that ships with JBoss Cache called the `BatchModeTransactionManager`. This transaction manager is not a true JTA transaction manager and should not be used for anything other than JBoss Cache. Its usage in JBoss Enterprise Application Platform is to get most of the benefits of JBoss Cache's transactional behavior for the session replication use cases, but without getting tangled up with end user transactions that may run during a request.

### 29.1.4. Concurrent Access

JBoss Cache is a thread safe caching API, and uses its own efficient mechanisms of controlling concurrent access. Concurrency is configured via the `nodeLockingScheme` and `isolationLevel` configuration attributes.

There are three choices for `nodeLockingScheme`:

- **MVCC** or multi-version concurrency control, is a locking scheme commonly used by modern database implementations to control fast, safe concurrent access to shared data. JBoss Cache 3.x uses an innovative implementation of MVCC as the default locking scheme. MVCC is designed to provide the following features for concurrent access:
  - Readers that do not block writers

- Writers that fail fast

It achieves this by using data versioning and copying for concurrent writers. The theory is that readers continue reading shared state, while writers copy the shared state, increment a version id, and write that shared state back after verifying that the version is still valid (i.e., another concurrent writer has not changed this state first).

MVCC is the recommended choice for JPA/Hibernate entity caching.

- **PESSIMISTIC** locking involves threads/transactions acquiring either exclusive or non-exclusive locks on nodes before reading or writing. Which is acquired depends on the `isolationLevel` (see below) but in most cases a non-exclusive lock is acquired for a read and an exclusive lock is acquired for a write. Pessimistic locking requires considerably more overhead than MVCC and allows lesser concurrency, since reader threads must block until a write has completed and released its exclusive lock (potentially a long time if the write is part of a transaction). A write will also be delayed due to ongoing reads.

Generally MVCC is a better choice than PESSIMISTIC, which is deprecated as of JBoss Cache 3.0. But, for the session caching usage in JBoss Enterprise Application Platform 5.0.0, PESSIMISTIC is still the default. This is largely because for the session use case there are generally not concurrent threads accessing the same cache location, so the benefits of MVCC are not as great.

- **OPTIMISTIC** locking seeks to improve upon the concurrency available with PESSIMISTIC by creating a "workspace" for each request/transaction that accesses the cache. Data accessed by the request/transaction (even reads) is *copied* into the workspace, which adds overhead. All data is versioned; on completion of non-transactional requests or commits of transactions the version of data in the workspace is compared to the main cache, and an exception is raised if there are inconsistencies. Otherwise changes to the workspace are applied to the main cache.

OPTIMISTIC locking is deprecated but is still provided to support backward compatibility. Users are encouraged to use MVCC instead, which provides the same benefits at lower cost.

The `isolationLevel` attribute has two possible values **READ\_COMMITTED** and **REPEATABLE\_READ** which correspond in semantic to database-style isolation levels. Previous versions of JBoss Cache supported all 5 database isolation levels, and if an unsupported isolation level is configured, it is either upgraded or downgraded to the closest supported level.

REPEATABLE\_READ is the default isolation level, to maintain compatibility with previous versions of JBoss Cache. READ\_COMMITTED, while providing a slightly weaker isolation, has a significant performance benefit over REPEATABLE\_READ.

### 29.1.5. JGroups Integration

Each JBoss Cache instance internally uses a JGroups `Channel` to handle group communications. Inside JBoss Enterprise Application Platform, we strongly recommend that you use the Enterprise Application Platform's JGroups Channel Factory service as the source for your cache's `Channel`. In this section we discuss how to configure your cache to get its channel from the Channel Factory; if you wish to configure the channel in some other way see the JBoss Cache documentation.

#### Caches obtained from the CacheManager Service

This is the simplest approach. The CacheManager service already has a reference to the Channel Factory service, so the only configuration task is to configure the name of the JGroups protocol stack configuration to use.



If you are configuring your cache via the CacheManager service's `jboss-cache-manager-jboss-beans.xml` file (see [Section 29.2.1, “Deployment Via the CacheManager Service”](#)), add the following to your cache configuration, where the value is the name of the protocol stack configuration.:

```
<property name="multiplexerStack">udp</property>
```

### Caches Deployed via a `-jboss-beans.xml` File

If you are deploying a cache via a JBoss Microcontainer `-jboss-beans.xml` file (see [Section 29.2.3, “Deployment Via a `-jboss-beans.xml` File”](#)), you need inject a reference to the Channel Factory service as well as specifying the protocol stack configuration:

```
<property name="runtimeConfig">
  <bean class="org.jboss.cache.config.RuntimeConfig">
    <property name="muxChannelFactory"><inject
bean="JChannelFactory"/></property>
  </bean>
</property>
<property name="multiplexerStack">udp</property>
```

### Caches Deployed via a `-service.xml` File

If you are deploying a cache MBean via `-service.xml` file (see [Section 29.2.2, “Deployment Via a `-service.xml` File”](#)), `CacheJmxWrapper` is the class of your MBean; that class exposes a `MuxChannelFactory` MBean attribute. You dependency inject the Channel Factory service into this attribute, and set the protocol stack name via the `MultiplexerStack` attribute:

```
<attribute name="MuxChannelFactory"><inject
bean="JChannelFactory"/></attribute>
<attribute name="MultiplexerStack">udp</attribute>
```

## 29.1.6. Eviction

Eviction allows the cache to control memory by removing data (typically the least frequently used data). If you wish to configure eviction for a custom cache, refer to the *JBoss Cache User Guide* available in the **JBoss Enterprise Application Platform 5** documentation suite at <https://access.redhat.com/knowledge/docs/>.

For web session caches, eviction should not be configured; the distributable session manager handles eviction itself. For EJB 3 SFSB caches, stick with the eviction configuration in the Enterprise Application Platform's standard `sfsb-cache` configuration (see [Section 21.2.1, “The JBoss Enterprise Application Platform CacheManager Service”](#)). The EJB container will configure eviction itself using the values included in each bean's configuration.

## 29.1.7. Cache Loaders

Cache loading allows JBoss Cache to store data in a persistent store in addition to what it keeps in memory. This data can either be an overflow, where the data in the persistent store is not reflected in memory. Or it can be a superset of what is in memory, where everything in memory is also reflected in the persistent store, along with items that have been evicted from memory. Which of these two modes is used depends on the setting of the `passivation` flag in the JBoss Cache cache loader configuration section. A `true` value means the persistent store acts as an overflow area written to when data is evicted from the in-memory cache.

If you wish to configure cache loading for a custom cache, see the JBoss Cache documentation for all of the available options. Do not configure cache loading for a JPA/Hibernate cache, as the database itself serves as a persistent store; adding a cache loader is just redundant.

The caches used for web session and EJB3 SFSB caching use passivation. Next we will discuss the cache loader configuration for those caches in some detail.

### 29.1.7.1. CacheLoader Configuration for Web Session and SFSB Caches

HttpSession and SFSB passivation rely on JBoss Cache's Cache Loader passivation for storing and retrieving the passivated sessions. Therefore the cache instance used by your webapp's clustered session manager or your bean's EJB container must be configured to enable Cache Loader passivation.

In most cases you do not need to do anything to alter the cache loader configurations for the standard web session and SFSB caches; the standard JBoss Enterprise Application Platform configurations should suit your needs. The following is a bit more detail in case you are interested or want to change from the defaults.

The Cache Loader configuration for the `standard-session-cache` config serves as a good example:

```
<property name="cacheLoaderConfig">
  <bean class="org.jboss.cache.config.CacheLoaderConfig">
    <!-- Do not change these -->
    <property name="passivation">true</property>
    <property name="shared">false</property>

    <property name="individualCacheLoaderConfigs">
      <list>
        <bean
class="org.jboss.cache.loader.FileCacheLoaderConfig">
          <!-- Where passivated sessions are stored -->
          <property
name="location">${jboss.server.data.dir}${/}session</property>
          <!-- Do not change these -->
          <property name="async">false</property>
          <property name="fetchPersistentState">true</property>
          <property name="purgeOnStartup">true</property>
          <property name="ignoreModifications">false</property>
          <property
name="checkCharacterPortability">false</property>
        </bean>
      </list>
    </property>
  </bean>
</property>
```

Some explanation:

- **passivation** property MUST be **true**
- **shared** property MUST be **false**. Do not passivate sessions to a shared persistent store, otherwise if another node activates the session, it will be gone from the persistent store and also gone from memory on other nodes that have passivated it. Backup copies will be lost.

- **individualCacheLoaderConfigs** property accepts a list of Cache Loader configurations. JBC allows you to chain cache loaders; see the JBoss Cache docs. For the session passivation use case a single cache loader is sufficient.
- **class** attribute on a cache loader config bean must refer to the configuration class for a cache loader implementation (e.g. `org.jboss.cache.loader.FileCacheLoaderConfig` or `org.jboss.cache.loader.JDBCCacheLoaderConfig`). See the JBoss Cache documentation for more on the available CacheLoader implementations. If you wish to use `JDBCCacheLoader` (to persist to a database rather than the file system used by `FileCacheLoader`) note the comment above about the `shared` property. Do not use a shared database, or at least not a shared table in the database. Each node in the cluster must have its own storage location.
- **location** property for `FileCacheLoaderConfig` defines the root node of the file system tree where passivated sessions should be stored. The default is to store them in your JBoss Enterprise Application Platform configuration's `data` directory.
- **async** MUST be `false` to ensure passivated sessions are promptly written to the persistent store.
- **fetchPersistentState** property MUST be `true` to ensure passivated sessions are included in the set of session backup copies transferred over from other nodes when the cache starts.
- **purgeOnStartup** should be `true` to ensure out-of-date session data left over from a previous shutdown of a server does not pollute the current data set.
- **ignoreModifications** should be `false`
- **checkCharacterPortability** should be `false` as a minor performance optimization.

### 29.1.8. Buddy Replication

Buddy Replication is a JBoss Cache feature that allows you to suppress replicating your data to all instances in a cluster. Instead, each instance picks one or more 'buddies' in the cluster, and only replicates to those specific buddies. This greatly helps scalability as there is no longer a memory and network traffic impact every time another instance is added to a cluster.

If the cache on another node needs data that it does not have locally, it can ask the other nodes in the cluster to provide it; nodes that have a copy will provide it as part of a process called "data gravitation". The new node will become the owner of the data, placing a backup copy of the data on its buddies. The ability to gravitate data means there is no need for all requests for data to occur on a node that has a copy of it; any node can handle a request for any data. However, data gravitation is expensive and should not be a frequent occurrence; ideally it should only occur if the node that is using some data fails or is shut down, forcing interested clients to fail over to a different node. This makes buddy replication primarily useful for session-type applications with session affinity (a.k.a. "sticky sessions") where all requests for a particular session are normally handled by a single server.

Buddy replication can be enabled for the web session and EJB3 SFSB caches. Do not add buddy replication to the cache configurations used for other standard clustering services (e.g. JPA/Hibernate caching). Services not specifically engineered for buddy replication are highly unlikely to work correctly if it is introduced.

Configuring buddy replication is fairly straightforward. As an example we will look at the buddy replication configuration section from the `CacheManager` service's `standard-session-cache` config:

■

```

<property name="buddyReplicationConfig">
  <bean class="org.jboss.cache.config.BuddyReplicationConfig">

    <!-- Just set to true to turn on buddy replication -->
    <property name="enabled">true</property>

    <!-- A way to specify a preferred replication group. We try
         and pick a buddy who shares the same pool name (falling
         back to other buddies if not available). -->
    <property name="buddyPoolName">default</property>

    <property name="buddyCommunicationTimeout">17500</property>

    <!-- Do not change these -->
    <property name="autoDataGravitation">false</property>
    <property name="dataGravitationRemoveOnFind">true</property>
    <property name="dataGravitationSearchBackupTrees">true</property>

    <property name="buddyLocatorConfig">
      <bean
class="org.jboss.cache.buddyreplication.NextMemberBuddyLocatorConfig">
        <!-- The number of backup copies we maintain -->
        <property name="numBuddies">1</property>
        <!-- Means that each node will *try* to select a buddy on
             a different physical host. If not able to do so
             though, it will fall back to colocated nodes. -->
        <property name="ignoreColocatedBuddies">true</property>
      </bean>
    </property>
  </bean>
</property>

```

The main things you would be likely to configure are:

- **buddyReplicationEnabled** – `true` if you want buddy replication; `false` if data should be replicated to all nodes in the cluster, in which case none of the other buddy replication configurations matter.
- **numBuddies** – to how many backup nodes should each node replicate its state.
- **buddyPoolName** – allows logical subgrouping of nodes within the cluster; if possible, buddies will be chosen from nodes in the same buddy pool.

The `ignoreColocatedBuddies` switch means that when the cache is trying to find a buddy, it will if possible not choose a buddy on the same physical host as itself. If the only server it can find is running on its own machine, it will use that server as a buddy.

Do not change the settings for `autoDataGravitation`, `dataGravitationRemoveOnFind` and `dataGravitationSearchBackupTrees`. Session replication will not work properly if these are changed.

## 29.2. DEPLOYING YOUR OWN JBOSS CACHE INSTANCE

It's quite common for users to deploy their own instances of JBoss Cache inside JBoss Enterprise Application Platform for custom use by their applications. In this section we describe the various ways caches can be deployed.

## 29.2.1. Deployment Via the CacheManager Service

The standard JBoss clustered services that use JBoss Cache obtain a reference to their cache from the Enterprise Application Platform's CacheManager service (see [Section 21.2.1, “The JBoss Enterprise Application Platform CacheManager Service”](#)). End user applications can do the same thing; here's how.

[Section 29.1.1, “Editing the CacheManager Configuration”](#) shows the configuration of the CacheManager's "CacheConfigurationRegistry" bean. To add a new configuration, you would add an additional element inside that bean's `newConfigurations` `<map>`:

```
<bean name="CacheConfigurationRegistry"
class="org.jboss.ha.cachemanager.DependencyInjectedConfigurationRegistry">
    .....
    <property name="newConfigurations">
        <map keyClass="java.lang.String"
valueClass="org.jboss.cache.config.Configuration">

            <entry><key>my-custom-cache</key>
                <value>
                    <bean name="MyCustomCacheConfig"
class="org.jboss.cache.config.Configuration">
                        .... details of the my-custom-cache configuration
                    </bean>
                </value>
            </entry>
            .....
        </map>
    </property>
</bean>
```

See [Section 29.1.1, “Editing the CacheManager Configuration”](#) for an example configuration.

### 29.2.1.1. Accessing the CacheManager

Once you've added your cache configuration to the CacheManager, the next step is to provide a reference to the CacheManager to your application. There are three ways to do this:

- **Dependency Injection**

If your application uses the JBoss Microcontainer for configuration, the simplest mechanism is to have it inject the CacheManager into your service.

```
<bean name="MyService" class="com.example.MyService">
    <property name="cacheManager"><inject
bean="CacheManager"/></property>
</bean>
```

- **JNDI Lookup**

Alternatively, you can find look up the CacheManger is JNDI. It is bound under `java:CacheManager`.

```
import org.jboss.ha.cachemanager.CacheManager;

public class MyService {
    private CacheManager cacheManager;
```

```

    public void start() throws Exception {
        Context ctx = new InitialContext();
        cacheManager = (CacheManager)
ctx.lookup("java:CacheManager");
    }
}

```

- **CacheManagerLocator**

JBoss Enterprise Application Platform also provides a service locator object that can be used to access the CacheManager.

```

import org.jboss.ha.cachemanager.CacheManager;
import org.jboss.ha.framework.server.CacheManagerLocator;

public class MyService {
    private CacheManager cacheManager;

    public void start() throws Exception {
        CacheManagerLocator locator =
CacheManagerLocator.getCacheManagerLocator();
        // Locator accepts as param a set of JNDI properties to help
in lookup;
        // this is not necessary inside the Enterprise Application
Platform
        cacheManager = locator.getCacheManager(null);
    }
}

```

Once a reference to the CacheManager is obtained; usage is simple. Access a cache by passing in the name of the desired configuration. The CacheManager will not start the cache; this is the responsibility of the application. The cache may, however, have been started by another application running in the cache server; the cache may be shared. When the application is done using the cache, it should not stop. Just inform the CacheManager that the cache is no longer being used; the manager will stop the cache when all callers that have asked for the cache have released it.

```

import org.jboss.cache.Cache;
import org.jboss.ha.cachemanager.CacheManager;
import org.jboss.ha.framework.server.CacheManagerLocator;

public class MyService {
    private CacheManager cacheManager;
    private Cache cache;

    public void start() throws Exception {
        Context ctx = new InitialContext();
        cacheManager = (CacheManager) ctx.lookup("java:CacheManager");

        // "true" param tells the manager to instantiate the cache if
// it does not exist yet
        cache = cacheManager.getCache("my-cache-config", true);

        cache.start();
    }
}

```

```

    public void stop() throws Exception {
        cacheManager.releaseCache("my-cache-config");
    }
}

```

The CacheManager can also be used to access instances of POJO Cache.

```

import org.jboss.cache.pojo.PojoCache;
import org.jboss.ha.cachemanager.CacheManager;
import org.jboss.ha.framework.server.CacheManagerLocator;

public class MyService {
    private CacheManager cacheManager;
    private PojoCache pojoCache;

    public void start() throws Exception {
        Context ctx = new InitialContext();
        cacheManager = (CacheManager) ctx.lookup("java:CacheManager");

        // "true" param tells the manager to instantiate the cache if
        // it does not exist yet
        pojoCache = cacheManager.getPojoCache("my-cache-config", true);

        pojoCache.start();
    }

    public void stop() throws Exception {
        cacheManager.releaseCache("my-cache-config");
    }
}

```

### 29.2.2. Deployment Via a -service.xml File

As in JBoss Enterprise Application Platform 4.x, you can also deploy a JBoss Cache instance as an MBean service via a `-service.xml` file. The primary difference from JBoss Enterprise Application Platform 4.x is the value of the `code` attribute in the `mbean` element. In JBoss Enterprise Application Platform 4.x, this was `org.jboss.cache.TreeCache`; in JBoss Enterprise Application Platform 5.x it is `org.jboss.cache.jmx.CacheJmxWrapper`. Here's an example:

```

<?xml version="1.0" encoding="UTF-8"?>

<server>
  <mbean code="org.jboss.cache.jmx.CacheJmxWrapper"
        name="foo:service=ExampleCacheJmxWrapper">

    <attribute name="TransactionManagerLookupClass">
      org.jboss.cache.transaction.JBossTransactionManagerLookup
    </attribute>

    <attribute name="MuxChannelFactory"><inject
bean="JChannelFactory"/></attribute>

    <attribute name="MultiplexerStack">udp</attribute>
    <attribute name="ClusterName">Example-EntityCache</attribute>

```

```

<attribute name="IsolationLevel">REPEATABLE_READ</attribute>
<attribute name="CacheMode">REPL_SYNC</attribute>
<attribute name="InitialStateRetrievalTimeout">15000</attribute>
<attribute name="SyncReplTimeout">20000</attribute>
<attribute name="LockAcquisitionTimeout">15000</attribute>
<attribute name="ExposeManagementStatistics">true</attribute>

</mbean>
</server>

```

The `CacheJmxWrapper` is not the cache itself (i.e. you can not store stuff in it). Rather, as its name implies, it's a wrapper around an `org.jboss.cache.Cache` that handles integration with JMX. `CacheJmxWrapper` exposes the `org.jboss.cache.Cache` via its `CacheJmxWrapperMBean` MBean interfaces `Cache` attribute; services that need the cache can obtain a reference to it via that attribute.

### 29.2.3. Deployment Via a `-jboss-beans.xml` File

Much like it can deploy MBean services described with a `-service.xml`, JBoss Enterprise Application Platform 5 can also deploy services that consist of Plain Old Java Objects (POJOs) if the POJOs are described using the JBoss Microcontainer schema in a `-jboss-beans.xml` file. You create such a file and deploy it, either directly in the `deploy` dir, or packaged in an ear or sar. Following is an example:

```

<?xml version="1.0" encoding="UTF-8"?>

<deployment xmlns="urn:jboss:bean-deployer:2.0">

  <!-- First we create a Configuration object for the cache -->
  <bean name="ExampleCacheConfig"
        class="org.jboss.cache.config.Configuration">

    <!-- Externally injected services -->
    <property name="runtimeConfig">
      <bean name="ExampleCacheRuntimeConfig"
            class="org.jboss.cache.config.RuntimeConfig">
        <property name="transactionManager">
          <inject bean="jboss:service=TransactionManager"
                  property="TransactionManager"/>
        </property>
        <property name="muxChannelFactory"><inject
bean="JChannelFactory"/></property>
      </bean>
    </property>

    <property name="multiplexerStack">udp</property>
    <property name="clusterName">Example-EntityCache</property>
    <property name="isolationLevel">REPEATABLE_READ</property>
    <property name="cacheMode">REPL_SYNC</property>
    <property name="initialStateRetrievalTimeout">15000</property>
    <property name="syncReplTimeout">20000</property>
    <property name="lockAcquisitionTimeout">15000</property>
    <property name="exposeManagementStatistics">true</property>

  </bean>

  <!-- Factory to build the Cache. -->

```



```

    <bean name="DefaultCacheFactory"
class="org.jboss.cache.DefaultCacheFactory">
    <constructor factoryClass="org.jboss.cache.DefaultCacheFactory" />
</bean>

<!-- The cache itself -->
<bean name="ExampleCache" class="org.jboss.cache.Cache">
    <constructor factoryMethod="createCache">
        <factory bean="DefaultCacheFactory"/>
        <parameter class="org.jboss.cache.config.Configuration"><inject
bean="ExampleCacheConfig"/></parameter>
        <parameter class="boolean">>false</false>
    </constructor>
</bean>

<bean name="ExampleService" class="org.foo.ExampleService">
    <property name="cache"><inject bean="ExampleCache"/></property>
</bean>

</deployment>

```

The bulk of the above is the creation of a JBoss Cache **Configuration** object; this is the same as what we saw in the configuration of the CacheManager service (see [Section 29.1.1, “Editing the CacheManager Configuration”](#)). In this case we are not using the CacheManager service as a cache factory, so instead we create our own factory bean and then use it to create the cache (the "ExampleCache" bean). The "ExampleCache" is then injected into a (fictitious) service that needs it.

An interesting thing to note in the above example is the use of the **RuntimeConfig** object. External resources like a **TransactionManager** and a **JGroups ChannelFactory** that are visible to the microcontainer are dependency injected into the **RuntimeConfig**. The assumption here is that in some other deployment descriptor in the Enterprise Application Platform, the referenced beans have already been described.

Using the configuration above, the "ExampleCache" cache will not be visible in JMX. Here's an alternate approach that results in the cache being bound into JMX:

```

<?xml version="1.0" encoding="UTF-8"?>

<deployment xmlns="urn:jboss:bean-deployer:2.0">

    <!-- First we create a Configuration object for the cache -->
    <bean name="ExampleCacheConfig"
        class="org.jboss.cache.config.Configuration">

        .... same as above

    </bean>

    <bean name="ExampleCacheJmxWrapper"
class="org.jboss.cache.jmx.CacheJmxWrapper">

        <annotation>@org.jboss.aop.microcontainer.aspects.jmx.JMX
        (name="foo:service=ExampleCacheJmxWrapper",

exposedInterface=org.jboss.cache.jmx.CacheJmxWrapperMBean.class,
        registerDirectly=true)

```

```
        </annotation>

        <property name="configuration"><inject
bean="ExampleCacheConfig"/></property>

    </bean>

    <bean name="ExampleService" class="org.foo.ExampleService">
        <property name="cache"><inject bean="ExampleCacheJmxWrapper"
property="cache"/></property>
    </bean>

</deployment>
```

Here the "ExampleCacheJmxWrapper" bean handles the task of creating the cache from the configuration. `CacheJmxWrapper` is a JBoss Cache class that provides an MBean interface for a cache. Adding an `<annotation>` element binds the JBoss Microcontainer `@JMX` annotation to the bean; that in turn results in JBoss Enterprise Application Platform registering the bean in JXM as part of the deployment process.

The actual underlying `org.jboss.cache.Cache` instance is available from the `CacheJmxWrapper` via its `cache` property; the example shows how this can be used to inject the cache into the "ExampleService".

## PART IV. LEGACY EJB SUPPORT

## CHAPTER 30. EJBS ON JBOSS

### *The EJB Container Configuration and Architecture*

The JBoss EJB container architecture employs a modular plug-in approach. All key aspects of the EJB container may be replaced by custom versions of a plug-in and/or an interceptor by a developer. This approach allows for fine tuned customization of the EJB container behavior to optimally suite your needs. Most of the EJB container behavior is configurable through the EJB JAR `META-INF/jboss.xml` descriptor and the default server-wide equivalent `standardjboss.xml` descriptor. We will look at various configuration capabilities throughout this chapter as we explore the container architecture.

### 30.1. THE EJB CLIENT SIDE VIEW

We will begin our tour of the EJB container by looking at the client view of an EJB through the home and remote proxies. It is the responsibility of the container provider to generate the `javax.ejb.EJBHome` and `javax.ejb.EJBObject` for an EJB implementation. A client never references an EJB bean instance directly, but rather references the `EJBHome` which implements the bean home interface, and the `EJBObject` which implements the bean remote interface. [Figure 30.1, “The composition of an EJBHome proxy in JBoss.”](#) shows the composition of an EJB home proxy and its relation to the EJB deployment.

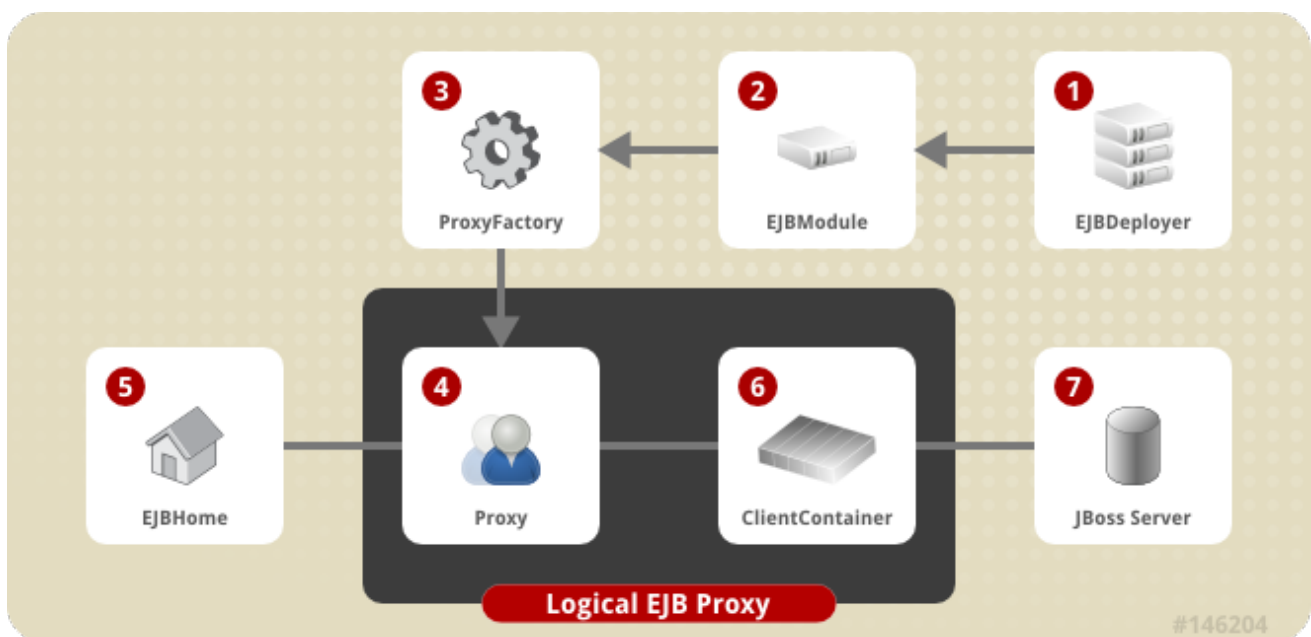

Figure 30.1. The composition of an EJBHome proxy in JBoss.

The numbered items in the figure are:

1. The `EJBDeployer` (`org.jboss.ejb.EJBDeployer`) is invoked to deploy an EJB JAR. An `EJBModule` (`org.jboss.ejb.EJBModule`) is created to encapsulate the deployment metadata.
2. The create phase of the `EJBModule` life cycle creates an `EJBProxyFactory` (`org.jboss.ejb.EJBProxyFactory`) that manages the creation of EJB home and remote interface proxies based on the `EJBModuleInvoker-proxy-bindings` metadata. There can be multiple proxy factories associated with an EJB and we will look at how this is defined shortly.
3. The `ProxyFactory` constructs the logical proxies and binds the homes into JNDI. A logical

proxy is composed of a dynamic `Proxy` (`java.lang.reflect.Proxy`), the home interfaces of the EJB that the proxy exposes, the `ProxyHandler` (`java.lang.reflect.InvocationHandler`) implementation in the form of the `ClientContainer` (`org.jboss.proxy.ClientContainer`), and the client side interceptors.

4. The proxy created by the `EJBProxyFactory` is a standard dynamic proxy. It is a serializable object that proxies the EJB home and remote interfaces as defined in the `EJBModule` metadata. The proxy translates requests made through the strongly typed EJB interfaces into a detyped invocation using the `ClientContainer` handler associated with the proxy. It is the dynamic proxy instance that is bound into JNDI as the EJB home interface that clients lookup. When a client does a lookup of an EJB home, the home proxy is transported into the client VM along with the `ClientContainer` and its interceptors. The use of dynamic proxies avoids the EJB specific compilation step required by many other EJB containers.
5. The EJB home interface is declared in the `ejb-jar.xml` descriptor and available from the `EJBModule` metadata. A key property of dynamic proxies is that they are seen to implement the interfaces they expose. This is true in the sense of Java's strong type system. A proxy can be cast to any of the home interfaces and reflection on the proxy provides the full details of the interfaces it proxies.
6. The proxy delegates calls made through any of its interfaces to the `ClientContainer` handler. The single method required of the handler is: `public Object invoke(Object proxy, Method m, Object[] args) throws Throwable`. The `EJBProxyFactory` creates a `ClientContainer` and assigns this as the `ProxyHandler`. The `ClientContainer`'s state consists of an `InvocationContext` (`org.jboss.invocation.InvocationContext`) and a chain of interceptors (`org.jboss.proxy.Interceptor`). The `InvocationContext` contains:
  - o the JMX `ObjectName` of the EJB container MBean the `Proxy` is associated with
  - o the `javax.ejb.EJBMetaData` for the EJB
  - o the JNDI name of the EJB home interface
  - o the transport specific invoker (`org.jboss.invocation.Invoker`)

The interceptor chain consists of the functional units that make up the EJB home or remote interface behavior. This is a configurable aspect of an EJB as we will see when we discuss the `jboss.xml` descriptor, and the interceptor makeup is contained in the `EJBModule` metadata. Interceptors (`org.jboss.proxy.Interceptor`) handle the different EJB types, security, transactions and transport. You can add your own interceptors as well.

7. The transport specific invoker associated with the proxy has an association to the server side detached invoker that handles the transport details of the EJB method invocation. The detached invoker is a server side component.

The configuration of the client side interceptors is done using the `jboss.xml:client-interceptors` element. When the `ClientContainer` `invoke` method is called it creates an un-typed `Invocation` (`org.jboss.invocation.Invocation`) to encapsulate request. This is then passed through the interceptor chain. The last interceptor in the chain will be the transport handler that knows how to send the request to the server and obtain the reply, taking care of the transport specific details.

As an example of the client interceptor configuration usage, consider the default stateless session bean configuration found in the `server/production/standardjboss.xml` descriptor.

Example 30.1, “The client-interceptors from the Standard Stateless SessionBean configuration.” shows the `stateless-rmi-invoker` client interceptors configuration referenced by the Standard Stateless SessionBean.

**Example 30.1. The client-interceptors from the Standard Stateless SessionBean configuration.**

```

<invoker-proxy-binding>
  <name>stateless-rmi-invoker</name>
  <invoker-mbean>jboss:service=invoker,type=jrmp</invoker-mbean>
  <proxy-factory>org.jboss.proxy.ejb.ProxyFactory</proxy-factory>
    <proxy-factory-config>
      <client-interceptors>
        <home>

<interceptor>org.jboss.proxy.ejb.HomeInterceptor</interceptor>

<interceptor>org.jboss.proxy.SecurityInterceptor</interceptor>

<interceptor>org.jboss.proxy.TransactionInterceptor</interceptor>
  <interceptor call-by-value="false">
    org.jboss.invocation.InvokerInterceptor
  </interceptor>
  <interceptor call-by-value="true">
    org.jboss.invocation.MarshallingInvokerInterceptor
  </interceptor>
  </home>
</bean>

<interceptor>org.jboss.proxy.ejb.StatelessSessionInterceptor</intercepto
r>

<interceptor>org.jboss.proxy.SecurityInterceptor</interceptor>

<interceptor>org.jboss.proxy.TransactionInterceptor</interceptor>
  <interceptor call-by-value="false">
    org.jboss.invocation.InvokerInterceptor
  </interceptor>
  <interceptor call-by-value="true">
    org.jboss.invocation.MarshallingInvokerInterceptor
  </interceptor>
</bean>
</client-interceptors>
</proxy-factory-config>
</invoker-proxy-binding>

<container-configuration>
  <container-name>Standard Stateless SessionBean</container-name>
  <call-logging>>false</call-logging>
  <invoker-proxy-binding-name>stateless-rmi-invoker</invoker-proxy-
binding-name>
  <!-- ... -->
</container-configuration>

```

This is the client interceptor configuration for stateless session beans that is used in the absence of an EJB JAR `META-INF/jboss.xml` configuration that overrides these settings. The functionality provided by each client interceptor is:

- **org.jboss.proxy.ejb.HomeInterceptor:** handles the `getHomeHandle`, `getEJBMetaData`, and `remove` methods of the `EJBHome` interface locally in the client VM. Any other methods are propagated to the next interceptor.
- **org.jboss.proxy.ejb.StatelessSessionInterceptor:** handles the `toString`, `equals`, `hashCode`, `getHandle`, `getEJBHome` and `isIdentical` methods of the `EJBObject` interface locally in the client VM. Any other methods are propagated to the next interceptor.
- **org.jboss.proxy.SecurityInterceptor:** associates the current security context with the method invocation for use by other interceptors or the server.
- **org.jboss.proxy.TransactionInterceptor:** associates any active transaction with the invocation method invocation for use by other interceptors.
- **org.jboss.invocation.InvokerInterceptor:** encapsulates the dispatch of the method invocation to the transport specific invoker. It knows if the client is executing in the same VM as the server and will optimally route the invocation to a by reference invoker in this situation. When the client is external to the server VM, this interceptor delegates the invocation to the transport invoker associated with the invocation context. In the case of the [Example 30.1, “The client-interceptors from the Standard Stateless SessionBean configuration.”](#) configuration, this would be the invoker stub associated with the `jboss:service=invoker, type=jrmp`, the `JRMPInvoker` service.

**org.jboss.invocation.MarshallingInvokerInterceptor:** extends the `InvokerInterceptor` to not optimize in-VM invocations. This is used to force `call-by-value` semantics for method calls.

### 30.1.1. Specifying the EJB Proxy Configuration

To specify the EJB invocation transport and the client proxy interceptor stack, you need to define an `invoker-proxy-binding` in either the EJB JAR `META-INF/jboss.xml` descriptor, or the server `standardjboss.xml` descriptor. There are several default `invoker-proxy-bindings` defined in the `standardjboss.xml` descriptor for the various default EJB container configurations and the standard RMI/JRMP and RMI/IIOP transport protocols. The current default proxy configurations are:

- **entity-rmi-invoker:** a RMI/JRMP configuration for entity beans
- **clustered-entity-rmi-invoker:** a RMI/JRMP configuration for clustered entity beans
- **stateless-rmi-invoker:** a RMI/JRMP configuration for stateless session beans
- **clustered-stateless-rmi-invoker:** a RMI/JRMP configuration for clustered stateless session beans
- **stateful-rmi-invoker:** a RMI/JRMP configuration for clustered stateful session beans
- **clustered-stateful-rmi-invoker:** a RMI/JRMP configuration for clustered stateful session beans
- **message-driven-bean:** a JMS invoker for message driven beans

- **singleton-message-driven-bean**: a JMS invoker for singleton message driven beans
- **message-inflow-driven-bean**: a JMS invoker for message inflow driven beans
- **jms-message-inflow-driven-bean**: a JMS inflow invoker for standard message driven beans
- **iiop**: a RMI/IIOP for use with session and entity beans.

To introduce a new protocol binding, or customize the proxy factory, or the client side interceptor stack, requires defining a new **invoker-proxy-binding**. The full **invoker-proxy-binding** DTD fragment for the specification of the proxy configuration is given in [Figure 30.2, “The invoker-proxy-binding schema”](#).

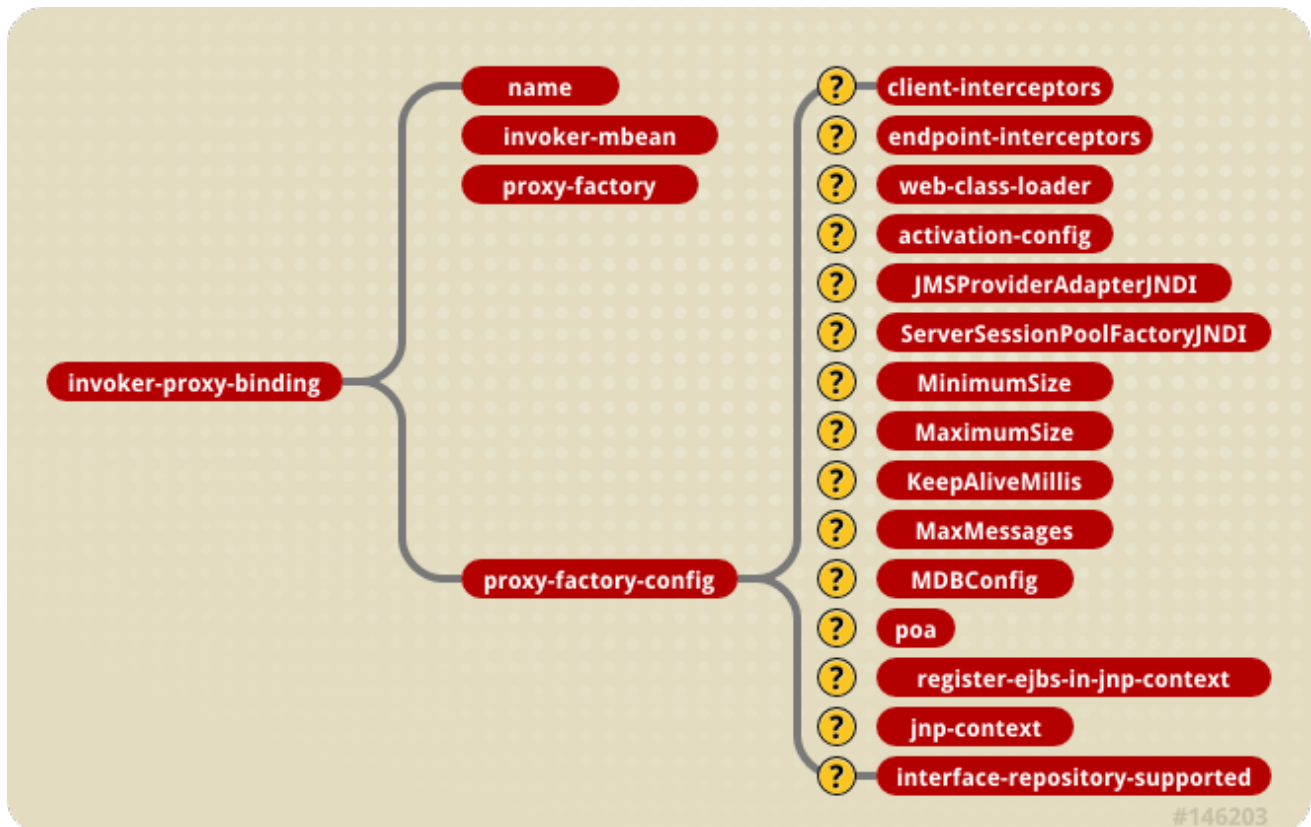

Figure 30.2. The invoker-proxy-binding schema

The **invoker-proxy-binding** child elements are:

- **name**: The **name** element gives a unique name for the **invoker-proxy-binding**. The name is used to reference the binding from the EJB container configuration when setting the default proxy binding as well as the EJB deployment level to specify additional proxy bindings. You will see how this is done when we look at the `jboss.xml` elements that control the server side EJB container configuration.
- **invoker-mbean**: The **invoker-mbean** element gives the JMX `ObjectName` string of the detached invoker MBean service the proxy invoker will be associated with.
- **proxy-factory**: The **proxy-factory** element specifies the fully qualified class name of the proxy factory, which must implement the `org.jboss.ejb.EJBProxyFactory` interface. The `EJBProxyFactory` handles the configuration of the proxy and the association of the protocol specific invoker and context. The current JBoss implementations of the `EJBProxyFactory` interface include:



- `org.jboss.proxy.ejb.ProxyFactory`: The RMI/JRMP specific factory.
- `org.jboss.proxy.ejb.ProxyFactoryHA`: The cluster RMI/JRMP specific factory.
- `org.jboss.ejb.plugins.jms.JMSContainerInvoker`: The JMS specific factory.
- `org.jboss.proxy.ejb.IORFactory`: The RMI/IIOP specific factory.
- **proxy-factory-config**: The `proxy-factory-config` element specifies additional information for the `proxy-factory` implementation. Unfortunately, its currently an unstructured collection of elements. Only a few of the elements apply to each type of proxy factory. The child elements break down into the three invocation protocols: RMI/RJMP, RMI/IIOP and JMS.

For the RMI/JRMP specific proxy factories, `org.jboss.proxy.ejb.ProxyFactory` and `org.jboss.proxy.ejb.ProxyFactoryHA` the following elements apply:

- **client-interceptors**: The `client-interceptors` define the home, remote and optionally the multi-valued proxy interceptor stacks.
- **web-class-loader**: The web class loader defines the instance of the `org.jboss.web.WebClassLoader` that should be associated with the proxy for dynamic class loading.

The following `proxy-factory-config` is for an entity bean accessed over RMI.

```
<proxy-factory-config>
  <client-interceptors>
    <home>

<interceptor>org.jboss.proxy.ejb.HomeInterceptor</interceptor>

<interceptor>org.jboss.proxy.SecurityInterceptor</interceptor>

<interceptor>org.jboss.proxy.TransactionInterceptor</interceptor>
  <interceptor call-by-value="false">
    org.jboss.invocation.InvokerInterceptor
  </interceptor>
  <interceptor call-by-value="true">
    org.jboss.invocation.MarshallingInvokerInterceptor
  </interceptor>
  </home>
</bean>

<interceptor>org.jboss.proxy.ejb.EntityInterceptor</interceptor>

<interceptor>org.jboss.proxy.SecurityInterceptor</interceptor>

<interceptor>org.jboss.proxy.TransactionInterceptor</interceptor>
  <interceptor call-by-value="false">
    org.jboss.invocation.InvokerInterceptor
  </interceptor>
  <interceptor call-by-value="true">
    org.jboss.invocation.MarshallingInvokerInterceptor
  </interceptor>
</bean>
</list-entity>
```

```

<interceptor>org.jboss.proxy.ejb.ListEntityInterceptor</interceptor>

<interceptor>org.jboss.proxy.SecurityInterceptor</interceptor>

<interceptor>org.jboss.proxy.TransactionInterceptor</interceptor>
  <interceptor call-by-value="false">
    org.jboss.invocation.InvokerInterceptor
  </interceptor>
  <interceptor call-by-value="true">
    org.jboss.invocation.MarshallingInvokerInterceptor
  </interceptor>
</list-entity>
</client-interceptors>
</proxy-factory-config>

```

For the RMI/IIOP specific proxy factory, `org.jboss.proxy.ejb.IORFactory`, the following elements apply:

- **web-class-loader:** The web class loader defines the instance of the `org.jboss.web.WebClassLoader` that should be associated with the proxy for dynamic class loading.
- **poa:** The portable object adapter usage. Valid values are `per-servant` and `shared`.
- **register-ejbs-in-jnp-context:** A flag indicating if the EJBs should be register in JNDI.
- **jnp-context:** The JNDI context in which to register EJBs.
- **interface-repository-supported:** This indicates whether or not a deployed EJB has its own CORBA interface repository.

The following shows a `proxy-factory-config` for EJBs accessed over IIOP.

```

<proxy-factory-config>
  <web-class-loader>org.jboss.iiop.WebCL</web-class-loader>
  <poa>per-servant</poa>
  <register-ejbs-in-jnp-context>true</register-ejbs-in-jnp-context>
  <jnp-context>iiop</jnp-context>
</proxy-factory-config>

```

For the JMS specific proxy factory, `org.jboss.ejb.plugins.jms.JMSContainerInvoker`, the following elements apply:

- **MinimumSize:** This specifies the minimum pool size for MDBs processing. This defaults to 1.
- **MaximumSize:** This specifies the upper limit to the number of concurrent MDBs that will be allowed for the JMS destination. This defaults to 15.
- **MaxMessages:** This specifies the `maxMessages` parameter value for the `createConnectionConsumer` method of `javax.jms.QueueConnection` and `javax.jms.TopicConnection` interfaces, as well as the `maxMessages` parameter value for the `createDurableConnectionConsumer` method of `javax.jms.TopicConnection`. It is the maximum number of messages that can be assigned to a server session at one time. This defaults to 1. This value should not be modified from the default unless your JMS provider indicates this is supported.

- **KeepAliveMillis:** This specifies the keep alive time interval in milliseconds for sessions in the session pool. The default is 30000 (30 seconds).
- **MDBConfig:** Configuration for the MDB JMS connection behavior. Among the elements supported are:
  - **ReconnectIntervalSec:** The time to wait (in seconds) before trying to recover the connection to the JMS server.
  - **DeliveryActive:** Whether or not the MDB is active at start up. The default is true.
  - **DLQConfig:** Configuration for an MDB's dead letter queue, used when messages are redelivered too many times.
  - **JMSProviderAdapterJNDI:** The JNDI name of the JMS provider adapter in the `java:/` namespace. This is mandatory for an MDB and must implement `org.jboss.jms.jndi.JMSProviderAdapter`.
  - **ServerSessionPoolFactoryJNDI:** The JNDI name of the session pool in the `java:/` namespace of the JMS provider's session pool factory. This is mandatory for an MDB and must implement `org.jboss.jms.asf.ServerSessionPoolFactory`.

**Example 30.2, “A sample JMSContainerInvoker proxy-factory-config”** gives a sample **proxy-factory-config** fragment taken from the `standardjboss.xml` descriptor.

#### Example 30.2. A sample JMSContainerInvoker proxy-factory-config

```
<proxy-factory-config>
  <JMSProviderAdapterJNDI>DefaultJMSProvider</JMSProviderAdapterJNDI>

  <ServerSessionPoolFactoryJNDI>StdJMSPool</ServerSessionPoolFactoryJNDI>
  <MinimumSize>1</MinimumSize>
  <MaximumSize>15</MaximumSize>
  <KeepAliveMillis>30000</KeepAliveMillis>
  <MaxMessages>1</MaxMessages>
  <MDBConfig>
    <ReconnectIntervalSec>10</ReconnectIntervalSec>
    <DLQConfig>
      <DestinationQueue>queue/DLQ</DestinationQueue>
      <MaxTimesRedelivered>10</MaxTimesRedelivered>
      <TimeToLive>0</TimeToLive>
    </DLQConfig>
  </MDBConfig>
</proxy-factory-config>
```

## 30.2. THE EJB SERVER SIDE VIEW

Every EJB invocation must end up at a server hosted EJB container. In this section we will look at how invocations are transported to the server VM and find their way to the EJB container via the JMX bus.

### 30.2.1. Detached Invokers - The Transport Middlemen

We looked at the detached invoker architecture in the context of exposing RMI compatible interfaces

of MBean services earlier. Here we will look at how detached invokers are used to expose the EJB container home and bean interfaces to clients. The generic view of the invoker architecture is presented in [Figure 30.3, “The transport invoker server side architecture”](#).

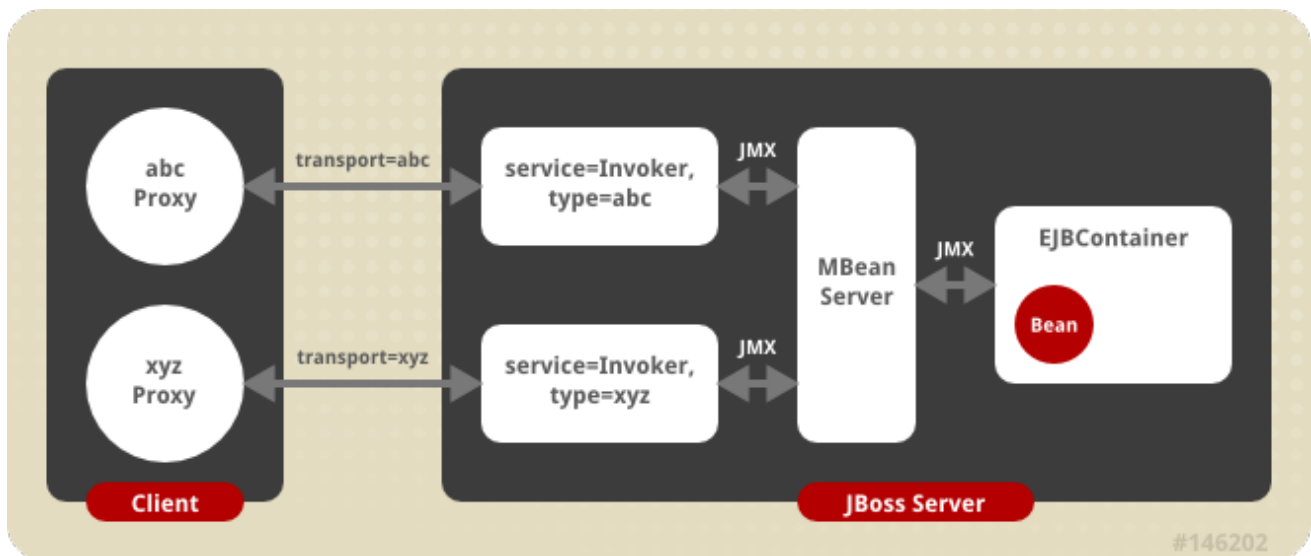

**Figure 30.3. The transport invoker server side architecture**

For each type of home proxy there is a binding to an invoker and its associated transport protocol. A container may have multiple invocation protocols active simultaneously. In the `jboss.xml` file, an `invoker-proxy-binding-name` maps to an `invoker-proxy-binding/name` element. At the `container-configuration` level this specifies the default invoker that will be used for EJBs deployed to the container. At the bean level, the `invoker-bindings` specify one or more invokers to use with the EJB container MBean.

When one specifies multiple invokers for a given EJB deployment, the home proxy must be given a unique JNDI binding location. This is specified by the `invoker/jndi-name` element value. Another issue when multiple invokers exist for an EJB is how to handle remote homes or interfaces obtained when the EJB calls other beans. Any such interfaces need to use the same invoker used to call the outer EJB in order for the resulting remote homes and interfaces to be compatible with the proxy the client has initiated the call through. The `invoker/ejb-ref` elements allow one to map from a protocol independent ENC `ejb-ref` to the home proxy binding for `ejb-ref` target EJB home that matches the referencing invoker type.

An example of using a custom `JRMPInvoker` MBean that enables compressed sockets for session beans can be found in the `org.jboss.test.jrmp` package of the testsuite. The following example illustrates the custom `JRMPInvoker` configuration and its mapping to a stateless session bean.

```
<server>
  <mbean code="org.jboss.invocation.jrmp.server.JRMPInvoker"
  name="jboss:service=invoker,type=jrmp,socketType=CompressionSocketFactory"
  >
    <attribute name="RMIObjectPort">4445</attribute>
    <attribute name="RMIClientSocketFactory">
      org.jboss.test.jrmp.ejb.CompressionClientSocketFactory
    </attribute>
    <attribute name="RMIServerSocketFactory">
      org.jboss.test.jrmp.ejb.CompressionServerSocketFactory
```

```

        </attribute>
    </mbean>
    </server>

```

Here the default **JRMPInvoker** has been customized to bind to port 4445 and to use custom socket factories that enable compression at the transport level.

```

<?xml version="1.0"?>
<!DOCTYPE jboss PUBLIC
    "-//JBoss//DTD JBOSS 3.2//EN"
    "http://www.jboss.org/j2ee/dtd/jboss_3_2.dtd">
<!-- The jboss.xml descriptor for the jrmp-comp.jar ejb unit -->
<jboss>
    <enterprise-beans>
        <session>
            <ejb-name>StatelessSession</ejb-name>
            <configuration-name>Standard Stateless
SessionBean</configuration-name>
            <invoker-bindings>
                <invoker>
                    <invoker-proxy-binding-name>
stateless-compression-invoker
                    </invoker-proxy-binding-name>
                    <jndi-name>jrmp-compressed/StatelessSession</jndi-
name>
                </invoker>
            </invoker-bindings>
        </session>
    </enterprise-beans>

    <invoker-proxy-bindings>
        <invoker-proxy-binding>
            <name>stateless-compression-invoker</name>
            <invoker-mbean>

jboss:service=invoker,type=jrmp,socketType=CompressionSocketFactory
            </invoker-mbean>
            <proxy-factory>org.jboss.proxy.ejb.ProxyFactory</proxy-
factory>
            <proxy-factory-config>
                <client-interceptors>
                    <home>

<interceptor>org.jboss.proxy.ejb.HomeInterceptor</interceptor>

<interceptor>org.jboss.proxy.SecurityInterceptor</interceptor>

<interceptor>org.jboss.proxy.TransactionInterceptor</interceptor>

<interceptor>org.jboss.invocation.InvokerInterceptor</interceptor>
                    </home>
                </client-interceptors>
            </proxy-factory-config>
        </invoker-proxy-binding>
    </invoker-proxy-bindings>

```

```

<interceptor>org.jboss.proxy.SecurityInterceptor</interceptor>

<interceptor>org.jboss.proxy.TransactionInterceptor</interceptor>

<interceptor>org.jboss.invocation.InvokerInterceptor</interceptor>
    </bean>
    </client-interceptors>
  </proxy-factory-config>
</invoker-proxy-binding>
</invoker-proxy-bindings>
</jboss>

```

The **StatelessSession EJB invoker - bindings** settings specify that the **stateless-compression-invoker** will be used with the home interface bound under the JNDI name **jrmp-compressed/StatelessSession**. The **stateless-compression-invoker** is linked to the custom JRMP invoker we just declared.

The following example, **org.jboss.test.hello** testsuite package, is an example of using the **HttpInvoker** to configure a stateless session bean to use the RMI/HTTP protocol.

```

<?xml version="1.0" encoding="UTF-8"?>
<!DOCTYPE jboss PUBLIC
    "-//JBoss//DTD JBOSS 3.2//EN"
    "http://www.jboss.org/j2ee/dtd/jboss_3_2.dtd">
<jboss>
  <enterprise-beans>
    <session>
      <ejb-name>HelloWorldViaHTTP</ejb-name>
      <jndi-name>helloworld/HelloHTTP</jndi-name>
      <invoker-bindings>
        <invoker>
          <invoker-proxy-binding-name>
            stateless-http-invoker
          </invoker-proxy-binding-name>
        </invoker>
      </invoker-bindings>
    </session>
  </enterprise-beans>
  <invoker-proxy-bindings>
    <!-- A custom invoker for RMI/HTTP -->
    <invoker-proxy-binding>
      <name>stateless-http-invoker</name>
      <invoker-mbean>jboss:service=invoker,type=http</invoker-
mbean>
      <proxy-factory>org.jboss.proxy.ejb.ProxyFactory</proxy-
factory>
      <proxy-factory-config>
        <client-interceptors>
          <home>

<interceptor>org.jboss.proxy.ejb.HomeInterceptor</interceptor>

<interceptor>org.jboss.proxy.SecurityInterceptor</interceptor>

<interceptor>org.jboss.proxy.TransactionInterceptor</interceptor>

```

```

<interceptor>org.jboss.invocation.InvokerInterceptor</interceptor>
    </home>
    <bean>
        <interceptor>
org.jboss.proxy.ejb.StatelessSessionInterceptor
        </interceptor>

<interceptor>org.jboss.proxy.SecurityInterceptor</interceptor>

<interceptor>org.jboss.proxy.TransactionInterceptor</interceptor>

<interceptor>org.jboss.invocation.InvokerInterceptor</interceptor>
    </bean>
    </client-interceptors>
</proxy-factory-config>
</invoker-proxy-binding>
</invoker-proxy-bindings>
</jboss>

```

Here a custom invoker-proxy-binding named `stateless-http-invoker` is defined. It uses the `HttpInvoker` MBean as the detached invoker. The `org.jboss:service=invoker,type=http` name is the default name of the `HttpInvoker` MBean as found in the `http-invoker.sar/META-INF/jboss-service.xml` descriptor, and its service descriptor fragment is show here:

```

<!-- The HTTP invoker service configuration -->
<mbean code="org.jboss.invocation.http.server.HttpInvoker"
    name="org.jboss:service=invoker,type=http">
    <!-- Use a URL of the form
http://<hostname>:8080/invoker/EJBInvokerServlet
    where <hostname> is InetAddress.getHostname value on which the
server
    is running. -->
    <attribute name="InvokerURLPrefix">http://</attribute>
    <attribute
name="InvokerURLSuffix">:8080/invoker/EJBInvokerServlet</attribute>
    <attribute name="UseHostName">true</attribute>
</mbean>

```

The client proxy posts the EJB invocation content to the `EJBInvokerServlet` URL specified in the `HttpInvoker` service configuration.

### 30.2.2. The HA JRMPInvoker - Clustered RMI/JRMP Transport

The `org.jboss.invocation.jrmp.server.JRMPInvokerHA` service is an extension of the `JRMPInvoker` that is a cluster aware invoker. The `JRMPInvokerHA` fully supports all of the attributes of the `JRMPInvoker`. This means that customized bindings of the port, interface and socket transport are available to clustered RMI/JRMP as well. For additional information on the clustering architecture and the implementation of the HA RMI proxies see the JBoss Clustering docs.

### 30.2.3. The HA HttpInvoker - Clustered RMI/HTTP Transport

The RMI/HTTP layer allows for software load balancing of the invocations in a clustered environment. An HA capable extension of the HTTP invoker has been added that borrows much of its functionality from the HA-RMI/JRMP clustering.

To enable HA-RMI/HTTP you need to configure the invokers for the EJB container. This is done through either a `jboss.xml` descriptor, or the `standardjboss.xml` descriptor. [Example 30.3, “A jboss.xml stateless session configuration for HA-RMI/HTTP”](#) shows is an example of a stateless session configuration taken from the `org.jboss.test.hello` testsuite package.

### Example 30.3. A jboss.xml stateless session configuration for HA-RMI/HTTP

```
<jboss>
  <enterprise-beans>
    <session>
      <ejb-name>HelloWorldViaClusteredHTTP</ejb-name>
      <jndi-name>helloworld/HelloHA-HTTP</jndi-name>
      <invoker-bindings>
        <invoker>
          <invoker-proxy-binding-name>
            stateless-httpHA-invoker
          </invoker-proxy-binding-name>
        </invoker>
      </invoker-bindings>
      <clustered>true</clustered>
    </session>
  </enterprise-beans>
  <invoker-proxy-bindings>
    <invoker-proxy-binding>
      <name>stateless-httpHA-invoker</name>
      <invoker-mbean>jboss:service=invoker,type=httpHA</invoker-
mbean>
      <proxy-factory>org.jboss.proxy.ejb.ProxyFactoryHA</proxy-
factory>
      <proxy-factory-config>
        <client-interceptors>
          <home>
            <interceptor>org.jboss.proxy.ejb.HomeInterceptor</interceptor>
            <interceptor>org.jboss.proxy.SecurityInterceptor</interceptor>
            <interceptor>org.jboss.proxy.TransactionInterceptor</interceptor>
            <interceptor>org.jboss.invocation.InvokerInterceptor</interceptor>
          </home>
          <bean>
            <interceptor>
              org.jboss.proxy.ejb.StatelessSessionInterceptor
            </interceptor>
          </bean>
        </client-interceptors>
      </proxy-factory-config>
    </invoker-proxy-binding>
  </invoker-proxy-bindings>
  <interceptor>org.jboss.proxy.SecurityInterceptor</interceptor>
  <interceptor>org.jboss.proxy.TransactionInterceptor</interceptor>
  <interceptor>org.jboss.invocation.InvokerInterceptor</interceptor>
</jboss>
```



```

        </bean>
    </client-interceptors>
</proxy-factory-config>
</invoker-proxy-binding>
</invoker-proxy-bindings>
</jboss>

```

The `stateless-httpHA-invoker` `invoker-proxy-binding` references the `jboss:service=invoker, type=httpHA` invoker service. This service would be configured as shown below.

```

<mbean code="org.jboss.invocation.http.server.HttpInvokerHA"
  name="jboss:service=invoker,type=httpHA">
  <!-- Use a URL of the form
    http://<hostname>:8080/invoker/EJBInvokerHAServlet
    where <hostname> is InetAddress.getHostname value on which the
server
    is running.
  -->
  <attribute name="InvokerURLPrefix">http://</attribute>
  <attribute
name="InvokerURLSuffix">:8080/invoker/EJBInvokerHAServlet</attribute>
  <attribute name="UseHostName">true</attribute>
</mbean>

```

The URL used by the invoker proxy is the `EJBInvokerHAServlet` mapping as deployed on the cluster node. The `HttpInvokerHA` instances across the cluster form a collection of candidate http URLs that are made available to the client side proxy for failover and/or load balancing.

## 30.3. THE EJB CONTAINER

An EJB container is the component that manages a particular class of EJB. In JBoss there is one instance of the `org.jboss.ejb.Container` created for each unique configuration of an EJB that is deployed. The actual object that is instantiated is a subclass of `Container` and the creation of the container instance is managed by the `EJBDeployer` MBean.

### 30.3.1. EJBDeployer MBean

The `org.jboss.ejb.EJBDeployer` MBean is responsible for the creation of EJB containers. Given an EJB JAR that is ready for deployment, the `EJBDeployer` will create and initialize the necessary EJB containers, one for each type of EJB. The configurable attributes of the `EJBDeployer` are:

- **VerifyDeployments:** a boolean flag indicating if the EJB verifier should be run. This validates that the EJBs in a deployment unit conform to the EJB 2.1 specification. Setting this to true is useful for ensuring your deployments are valid.
- **VerifierVerbose:** A boolean that controls the verbosity of any verification failures/warnings that result from the verification process.
- **StrictVerifier:** A boolean that enables/disables strict verification. When strict verification is enable an EJB will deploy only if verifier reports no errors.
- **CallByValue:** a boolean flag that indicates call by value semantics should be used by default.

- **ValidateDTDs**: a boolean flag that indicates if the `ejb-jar.xml` and `jboss.xml` descriptors should be validated against their declared DTDs. Setting this to true is useful for ensuring your deployment descriptors are valid.
- **MetricsEnabled**: a boolean flag that controls whether container interceptors marked with an `metricsEnabled=true` attribute should be included in the configuration. This allows one to define a container interceptor configuration that includes metrics type interceptors that can be toggled on and off.
- **WebServiceName**: The JMX ObjectName string of the web service MBean that provides support for the dynamic class loading of EJB classes.
- **TransactionManagerServiceName**: The JMX ObjectName string of the JTA transaction manager service. This must have an attribute named `TransactionManager` that returns that `javax.transaction.TransactionManager` instance.

The deployer contains two central methods: `deploy` and `undeploy`. The `deploy` method takes a URL, which either points to an EJB JAR, or to a directory whose structure is the same as a valid EJB JAR (which is convenient for development purposes). Once a deployment has been made, it can be undeployed by calling `undeploy` on the same URL. A call to `deploy` with an already deployed URL will cause an `undeploy`, followed by deployment of the URL. JBoss has support for full re-deployment of both implementation and interface classes, and will reload any changed classes. This will allow you to develop and update EJBs without ever stopping a running server.

During the deployment of the EJB JAR the `EJBDeployer` and its associated classes perform three main functions, verify the EJBs, create a container for each unique EJB, initialize the container with the deployment configuration information. We will talk about each function in the following sections.

### 30.3.1.1. Verifying EJB deployments

When the `VerifyDeployments` attribute of the `EJBDeployer` is true, the deployer performs a verification of EJBs in the deployment. The verification checks that an EJB meets EJB specification compliance. This entails validating that the EJB deployment unit contains the required home and remote, local home and local interfaces. It will also check that the objects appearing in these interfaces are of the proper types and that the required methods are present in the implementation class. This is a useful behavior that is enabled by default since there are a number of steps that an EJB developer and deployer must perform correctly to construct a proper EJB JAR, and it is easy to make a mistake. The verification stage attempts to catch any errors and fail the deployment with an error that indicates what needs to be corrected.

Probably the most problematic aspect of writing EJBs is the fact that there is a disconnection between the bean implementation and its remote and home interfaces, as well as its deployment descriptor configuration. It is easy to have these separate elements get out of sync. One tool that helps eliminate this problem is XDoclet. It allows you to use custom JavaDoc-like tags in the EJB bean implementation class to generate the related bean interfaces, deployment descriptors and related objects. See the XDoclet home page, <http://sourceforge.net/projects/xdoclet> for additional details.

### 30.3.1.2. Deploying EJBs Into Containers

The most important role performed by the `EJBDeployer` is the creation of an EJB container and the deployment of the EJB into the container. The deployment phase consists of iterating over EJBs in an EJB JAR, and extracting the bean classes and their metadata as described by the `ejb-jar.xml` and `jboss.xml` deployment descriptors. For each EJB in the EJB JAR, the following steps are performed:

- Create subclass of `org.jboss.ejb.Container` depending on the type of the EJB: stateless,

stateful, BMP entity, CMP entity, or message driven. The container is assigned a unique `ClassLoader` from which it can load local resources. The uniqueness of the `ClassLoader` is also used to isolate the standard `java:comp` JNDI namespace from other J2EE components.

- Set all container configurable attributes from a merge of the `jboss.xml` and `standardjboss.xml` descriptors.
- Create and add the container interceptors as configured for the container.
- Associate the container with an application object. This application object represents a J2EE enterprise application and may contain multiple EJBs and web contexts.

If all EJBs are successfully deployed, the application is started which in turn starts all containers and makes the EJBs available to clients. If any EJB fails to deploy, a deployment exception is thrown and the deployment module is failed.

### 30.3.1.3. Container configuration information

JBoss externalizes most if not all of the setup of the EJB containers using an XML file that conforms to the `jboss_4_0.dtd`. The section DTD that relates to container configuration information is shown in Figure 30.4, “The `jboss_4_0` DTD elements related to container configuration.” .



Figure 30.4. The `jboss_4_0` DTD elements related to container configuration.

The **container-configuration** element and its subelements specify container configuration settings for a type of container as given by the **container-name** element. Each configuration specifies information such as the default invoker type, the container interceptor makeup, instance caches/pools and their sizes, persistence manager, security, and so on. Because this is a large amount of information that requires a detailed understanding of the JBoss container architecture, JBoss ships with a standard configuration for the four types of EJBs. This configuration file is called **standardjboss.xml** and it is located in the conf directory of any configuration file set that uses EJBs. The following is a sample of **container-configuration** from **standardjboss.xml**.

```
<container-configuration>
  <container-name>Standard CMP 2.x EntityBean</container-name>
  <call-logging>>false</call-logging>
  <invoker-proxy-binding-name>entity-rmi-invoker</invoker-proxy-binding-
name>
  <sync-on-commit-only>>false</sync-on-commit-only>
  <insert-after-ejb-post-create>>false</insert-after-ejb-post-create>
  <call-ejb-store-on-clean>>true</call-ejb-store-on-clean>
  <container-interceptors>

<interceptor>org.jboss.ejb.plugins.ProxyFactoryFinderInterceptor</intercep
tor>
  <interceptor>org.jboss.ejb.plugins.LogInterceptor</interceptor>

<interceptor>org.jboss.ejb.plugins.SecurityInterceptor</interceptor>
  <interceptor>org.jboss.ejb.plugins.TxInterceptorCMT</interceptor>

<interceptor>org.jboss.ejb.plugins.CallValidationInterceptor</interceptor>
  <interceptor metricsEnabled="true">
    org.jboss.ejb.plugins.MetricsInterceptor
  </interceptor>

<interceptor>org.jboss.ejb.plugins.EntityCreationInterceptor</interceptor>

<interceptor>org.jboss.ejb.plugins.EntityLockInterceptor</interceptor>

<interceptor>org.jboss.ejb.plugins.EntityInstanceInterceptor</interceptor>

<interceptor>org.jboss.ejb.plugins.EntityReentranceInterceptor</intercepto
r>
  <interceptor>
org.jboss.resource.connectionmanager.CachedConnectionInterceptor
  </interceptor>

<interceptor>org.jboss.ejb.plugins.EntitySynchronizationInterceptor</inter
ceptor>

<interceptor>org.jboss.ejb.plugins.cmp.jdbc.JDBCRelationInterceptor</inter
ceptor>
  </container-interceptors>
  <instance-pool>org.jboss.ejb.plugins.EntityInstancePool</instance-
pool>
  <instance-
cache>org.jboss.ejb.plugins.InvalidableEntityInstanceCache</instance-
cache>
  <persistence-
```

```

manager>org.jboss.ejb.plugins.cmp.jdbc.JDBCStoreManager</persistence-
manager>
  <locking-
policy>org.jboss.ejb.plugins.lock.QueuedPessimisticEJBLock</locking-
policy>
  <container-cache-conf>
    <cache-
policy>org.jboss.ejb.plugins.LRUEnterpriseContextCachePolicy</cache-
policy>
    <cache-policy-conf>
      <min-capacity>50</min-capacity>
      <max-capacity>1000000</max-capacity>
      <overager-period>300</overager-period>
      <max-bean-age>600</max-bean-age>
      <resizer-period>400</resizer-period>
      <max-cache-miss-period>60</max-cache-miss-period>
      <min-cache-miss-period>1</min-cache-miss-period>
      <cache-load-factor>0.75</cache-load-factor>
    </cache-policy-conf>
  </container-cache-conf>
  <container-pool-conf>
    <MaximumSize>100</MaximumSize>
  </container-pool-conf>
  <commit-option>B</commit-option>
</container-configuration>

```

These two examples demonstrate how extensive the container configuration options are. The container configuration information can be specified at two levels. The first is in the `standardjboss.xml` file contained in the configuration file set directory. The second is at the EJB JAR level. By placing a `jboss.xml` file in the EJB JAR `META-INF` directory, you can specify either overrides for container configurations in the `standardjboss.xml` file, or entirely new named container configurations. This provides great flexibility in the configuration of containers. As you have seen, all container configuration attributes have been externalized and as such are easily modifiable. Knowledgeable developers can even implement specialized container components, such as instance pools or caches, and easily integrate them with the standard container configurations to optimize behavior for a particular application or environment.

How an EJB deployment chooses its container configuration is based on the explicit or implicit `jboss/enterprise-beans/<type>/configuration-name` element. The `configuration-name` element is a link to a `container-configurations/container-configuration` element. It specifies which container configuration to use for the referring EJB. The link is from a `configuration-name` element to a `container-name` element.

You are able to specify container configurations per class of EJB by including a `container-configuration` element in the EJB definition. Typically one does not define completely new container configurations, although this is supported. The typical usage of a `jboss.xml` level `container-configuration` is to override one or more aspects of a `container-configuration` coming from the `standardjboss.xml` descriptor. This is done by specifying `container-configuration` that references the name of an existing `standardjboss.xml` `container-configuration/container-name` as the value for the `container-configuration/extends` attribute. The following example shows an example of defining a new `Secured Stateless SessionBean` configuration that is an extension of the `Standard Stateless SessionBean` configuration.

```
<?xml version="1.0"?>
```

```

<jboss>
  <enterprise-beans>
    <session>
      <ejb-name>EchoBean</ejb-name>
      <configuration-name>Secured Stateless
SessionBean</configuration-name>
      <!-- ... -->
    </session>
  </enterprise-beans>
  <container-configurations>
    <container-configuration extends="Standard Stateless SessionBean">
      <container-name>Secured Stateless SessionBean</container-name>
      <!-- Override the container security domain -->
      <security-domain>java:/jaas/my-security-domain</security-
domain>
    </container-configuration>
  </container-configurations>
</jboss>

```

If an EJB does not provide a container configuration specification in the deployment unit EJB JAR, the container factory chooses a container configuration from the `standardjboss.xml` descriptor based on the type of the EJB. So, in reality there is an implicit `configuration-name` element for every type of EJB, and the mappings from the EJB type to default container configuration name are as follows:

- container-managed persistence entity version 2.0 = Standard CMP 2.x EntityBean
- container-managed persistence entity version 1.1 = Standard CMP EntityBean
- bean-managed persistence entity = Standard BMP EntityBean
- stateless session = Standard Stateless SessionBean
- stateful session = Standard Stateful SessionBean
- message driven = Standard Message Driven Bean

It is not necessary to indicate which container configuration an EJB is using if you want to use the default based on the bean type. It probably provides for a more self-contained descriptor to include the `configuration-name` element, but this is purely a matter of style.

Now that you know how to specify which container configuration an EJB is using and can define a deployment unit level override, we now will look at the `container-configuration` child elements in the following sections. A number of the elements specify interface class implementations whose configuration is affected by other elements, so before starting in on the configuration elements you need to understand the `org.jboss.metadata.XmlLoadable` interface.

The `XmlLoadable` interface is a simple interface that consists of a single method. The interface definition is:

```

import org.w3c.dom.Element;
public interface XmlLoadable
{
    public void importXml(Element element) throws Exception;
}

```

Classes implement this interface to allow their configuration to be specified via an XML document

fragment. The root element of the document fragment is what would be passed to the `importXml` method. You will see a few examples of this as the container configuration elements are described in the following sections.

#### 30.3.1.3.1. The container-name element

The `container-name` element specifies a unique name for a given configuration. EJBs link to a particular container configuration by setting their `configuration-name` element to the value of the `container-name` for the container configuration.

#### 30.3.1.3.2. The call-logging element

The `call-logging` element expects a boolean (true or false) as its value to indicate whether or not the `LogInterceptor` should log method calls to a container. This is somewhat obsolete with the change to `log4j`, which provides a fine-grained logging API.

#### 30.3.1.3.3. The invoker-proxy-binding-name element

The `invoker-proxy-binding-name` element specifies the name of the default invoker to use. In the absence of a bean level `invoker-bindings` specification, the `invoker-proxy-binding` whose name matches the `invoker-proxy-binding-name` element value will be used to create home and remote proxies.

#### 30.3.1.3.4. The sync-on-commit-only element

This configures a performance optimization that will cause entity bean state to be synchronized with the database only at commit time. Normally the state of all the beans in a transaction would need to be synchronized when a finder method is called or when an remove method is called, for example.

#### 30.3.1.3.5. insert-after-ejb-post-create

This is another entity bean optimization which cause the database insert command for a new entity bean to be delayed until the `ejbPostCreate` method is called. This allows normal CMP fields as well as CMR fields to be set in a single insert, instead of the default insert followed by an update, which allows removes the requirement for relation ship fields to allow null values.

#### 30.3.1.3.6. call-ejb-store-on-clean

By the specification the container is required to call `ejbStore` method on an entity bean instance when transaction commits even if the instance was not modified in the transaction. Setting this to false will cause JBoss to only call `ejbStore` for dirty objects.

#### 30.3.1.3.7. The container-interceptors Element

The `container-interceptors` element specifies one or more interceptor elements that are to be configured as the method interceptor chain for the container. The value of the interceptor element is a fully qualified class name of an `org.jboss.ejb.Interceptor` interface implementation. The container interceptors form a `linked-list` structure through which EJB method invocations pass. The first interceptor in the chain is invoked when the `MBeanServer` passes a method invocation to the container. The last interceptor invokes the business method on the bean. We will discuss the `Interceptor` interface latter in this chapter when we talk about the container plug-in framework. Generally, care must be taken when changing an existing standard EJB interceptor configuration as the EJB contract regarding security, transactions, persistence, and thread safety derive from the interceptors.

### 30.3.1.3.8. The instance-pool element

The `instance-pool` element specifies the fully qualified class name of an `org.jboss.ejb.InstancePool` interface implementation to use as the container `InstancePool`. We will discuss the `InstancePool` interface in detail later in this chapter when we talk about the container plug-in framework.

### 30.3.1.3.9. The container-pool-conf element

The `container-pool-conf` is passed to the `InstancePool` implementation class given by the `instance-pool` element if it implements the `XmlLoadable` interface. All current JBoss `InstancePool` implementations derive from the `org.jboss.ejb.plugins.AbstractInstancePool` class which provides support for elements shown in [Figure 30.5, “The container-pool-conf element DTD”](#).

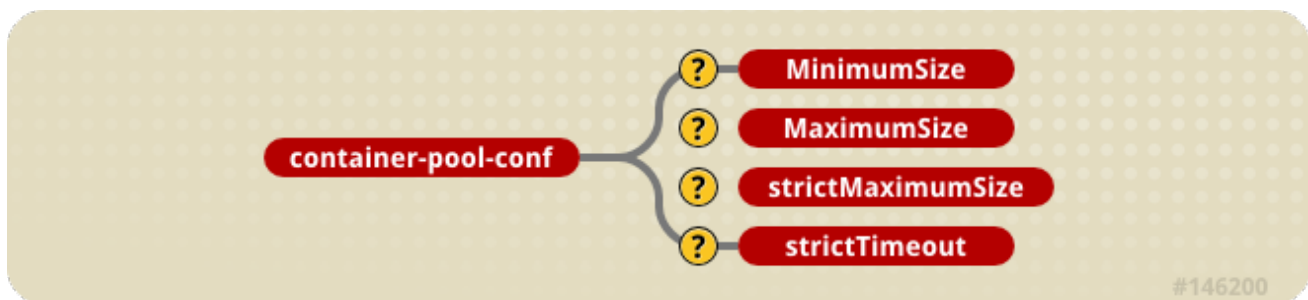

Figure 30.5. The container-pool-conf element DTD

- **MinimumSize:** The `MinimumSize` element gives the minimum number of instances to keep in the pool, although JBoss does not currently seed an `InstancePool` to the `MinimumSize` value.
- **MaximumSize:** The `MaximumSize` specifies the maximum number of pool instances that are allowed. The default use of `MaximumSize` may not be what you expect. The pool `MaximumSize` is the maximum number of EJB instances that are kept available, but additional instances can be created if the number of concurrent requests exceeds the `MaximumSize` value.
- **strictMaximumSize:** If you want to limit the maximum concurrency of an EJB to the pool `MaximumSize`, you need to set the `strictMaximumSize` element to true. When `strictMaximumSize` is true, only `MaximumSize` EJB instances may be active. When there are `MaximumSize` active instances, any subsequent requests will be blocked until an instance is freed back to the pool. The default value for `strictMaximumSize` is false.
- **strictTimeout:** How long a request blocks waiting for an instance pool object is controlled by the `strictTimeout` element. The `strictTimeout` defines the time in milliseconds to wait for an instance to be returned to the pool when there are `MaximumSize` active instances. A value less than or equal to 0 will mean not to wait at all. When a request times out waiting for an instance a `java.rmi.ServerException` is generated and the call aborted. This is parsed as a `Long` so the maximum possible wait time is 9,223,372,036,854,775,807 or about 292,471,208 years, and this is the default value.

### 30.3.1.3.10. The instance-cache element

The `instance-cache` element specifies the fully qualified class name of the `org.jboss.ejb.InstanceCache` interface implementation. This element is only meaningful for



entity and stateful session beans as these are the only EJB types that have an associated identity. We will discuss the `InstanceCache` interface in detail later in this chapter when we talk about the container plug-in framework.

### 30.3.1.3.11. The container-cache-conf element

The `container-cache-conf` element is passed to the `InstanceCache` implementation if it supports the `XmlLoadable` interface. All current JBoss `InstanceCache` implementations derive from the `org.jboss.ejb.plugins.AbstractInstanceCache` class which provides support for the `XmlLoadable` interface and uses the `cache-policy` child element as the fully qualified class name of an `org.jboss.util.CachePolicy` implementation that is used as the instance cache store. The `cache-policy-conf` child element is passed to the `CachePolicy` implementation if it supports the `XmlLoadable` interface. If it does not, the `cache-policy-conf` will silently be ignored.

There are two JBoss implementations of `CachePolicy` used by the `standardjboss.xml` configuration that support the current array of `cache-policy-conf` child elements. The classes are `org.jboss.ejb.plugins.LRUEnterpriseContextCachePolicy` and `org.jboss.ejb.plugins.LRUStatefulContextCachePolicy`. The `LRUEnterpriseContextCachePolicy` is used by entity bean containers while the `LRUStatefulContextCachePolicy` is used by stateful session bean containers. Both cache policies support the following `cache-policy-conf` child elements, shown in [Figure 30.6, “The container-cache-conf element DTD”](#).

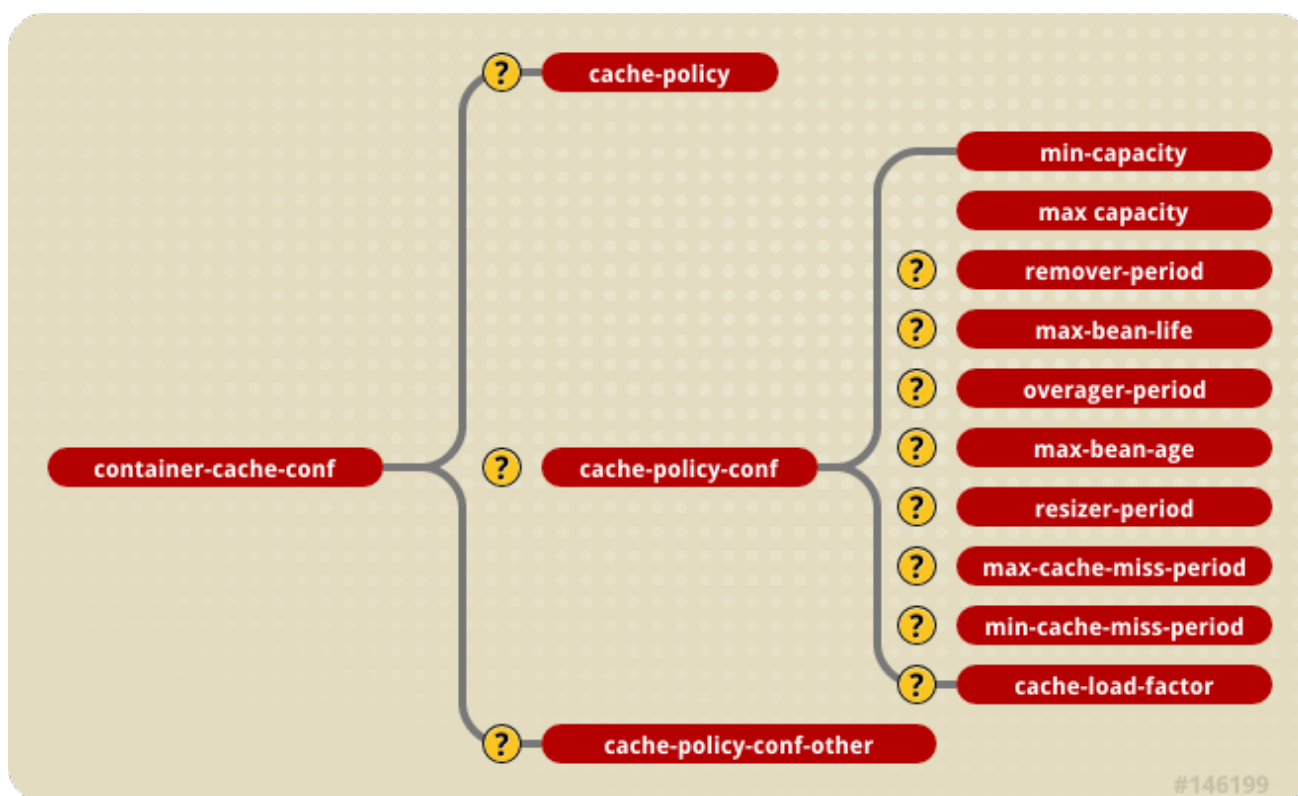

Figure 30.6. The container-cache-conf element DTD

- **min-capacity**: specifies the minimum capacity of this cache
- **max-capacity**: specifies the maximum capacity of the cache, which cannot be less than `min-capacity`.

- **overager-period**: specifies the period in seconds between runs of the overager task. The purpose of the overager task is to see if the cache contains beans with an age greater than the **max-bean-age** element value. Any beans meeting this criterion will be passivated.
- **max-bean-age**: specifies the maximum period of inactivity in seconds a bean can have before it will be passivated by the overager process.
- **resizer-period**: specifies the period in seconds between runs of the resizer task. The purpose of the resizer task is to contract or expand the cache capacity based on the remaining three element values in the following way. When the resizer task executes it checks the current period between cache misses, and if the period is less than the **min-cache-miss-period** value the cache is expanded up to the **max-capacity** value using the **cache-load-factor**. If instead the period between cache misses is greater than the **max-cache-miss-period** value the cache is contracted using the **cache-load-factor**.
- **max-cache-miss-period**: specifies the time period in seconds in which a cache miss should signal that the cache capacity be contracted. It is equivalent to the minimum miss rate that will be tolerated before the cache is contracted.
- **min-cache-miss-period**: specifies the time period in seconds in which a cache miss should signal that the cache capacity be expanded. It is equivalent to the maximum miss rate that will be tolerated before the cache is expanded.
- **cache-load-factor**: specifies the factor by which the cache capacity is contracted and expanded. The factor should be less than 1. When the cache is contracted the capacity is reduced so that the current ratio of beans to cache capacity is equal to the **cache-load-factor** value. When the cache is expanded the new capacity is determined as **current-capacity \* 1/cache-load-factor**. The actual expansion factor may be as high as 2 based on an internal algorithm based on the number of cache misses. The higher the cache miss rate the closer the true expansion factor will be to 2.

The `LRUStatefulContextCachePolicy` also supports the remaining child elements:

- **remover-period**: specifies the period in seconds between runs of the remover task. The remover task removes passivated beans that have not been accessed in more than **max-bean-life** seconds. This task prevents stateful session beans that were not removed by users from filling up the passivation store.
- **max-bean-life**: specifies the maximum period in seconds that a bean can exist inactive. After this period, as a result, the bean will be removed from the passivation store.

An alternative cache policy implementation is the `org.jboss.ejb.plugins.NoPassivationCachePolicy` class, which simply never passivates instances. It uses an in-memory `HashMap` implementation that never discards instances unless they are explicitly removed. This class does not support any of the `cache-policy-conf` configuration elements.

#### 30.3.1.3.12. The persistence-manager element

The `persistence-manager` element value specifies the fully qualified class name of the persistence manager implementation. The type of the implementation depends on the type of EJB. For stateful session beans it must be an implementation of the `org.jboss.ejb.StatefulSessionPersistenceManager` interface. For BMP entity beans it must

be an implementation of the `org.jboss.ejb.EntityPersistenceManager` interface, while for CMP entity beans it must be an implementation of the `org.jboss.ejb.EntityPersistenceStore` interface.

### 30.3.1.3.13. The web-class-loader Element

The `web-class-loader` element specifies a subclass of `org.jboss.web.WebClassLoader` that is used in conjunction with the `WebService` MBean to allow dynamic loading of resources and classes from deployed ears, EJB JARs and WARs. A `WebClassLoader` is associated with a `Container` and must have an `org.jboss.mx.loading.UnifiedClassLoader` as its parent. It overrides the `getURLs()` method to return a different set of URLs for remote loading than what is used for local loading.

`WebClassLoader` has two methods meant to be overridden by subclasses: `getKey()` and `getBytes()`. The latter is a no-op in this implementation and should be overridden by subclasses with bytecode generation ability, such as the classloader used by the `iiop` module.

`WebClassLoader` subclasses must have a constructor with the same signature as the `WebClassLoader(ObjectName containerName, UnifiedClassLoader parent)` constructor.

### 30.3.1.3.14. The locking-policy element

The `locking-policy` element gives the fully qualified class name of the EJB lock implementation to use. This class must implement the `org.jboss.ejb.BeanLock` interface. The current JBoss versions include:

- `org.jboss.ejb.plugins.lock.QueuedPessimisticEJBLOCK`: an implementation that holds threads awaiting the transactional lock to be freed in a fair FIFO queue. Non-transactional threads are also put into this wait queue as well. This class pops the next waiting transaction from the queue and notifies only those threads waiting associated with that transaction. The `QueuedPessimisticEJBLOCK` is the current default used by the standard configurations.
- `org.jboss.ejb.plugins.lock.QueuedPessimisticEJBLOCKNoADE`: This behaves the same as the `QueuedPessimisticEJBLOCK` except that deadlock detection is disabled.
- `org.jboss.ejb.plugins.lock.SimpleReadWriteEJBLOCK`: This lock allows multiple read locks concurrently. Once a writer has requested the lock, future read-lock requests whose transactions do not already have the read lock will block until all writers are done; then all the waiting readers will concurrently go (depending on the `reentrant` setting / `methodLock`). A reader who promotes gets first crack at the write lock, ahead of other waiting writers. If there is already a reader that is promoting, we throw an inconsistent read exception. Of course, writers have to wait for all read-locks to release before taking the write lock.
- `org.jboss.ejb.plugins.lock.NoLock`: an anti-locking policy used with the instance per transaction container configurations.

Locking and deadlock detection will be discussed in more detail in [Section 30.4, “Entity Bean Locking and Deadlock Detection”](#).

### 30.3.1.3.15. The commit-option and optiond-refresh-rate elements

The `commit-option` value specifies the EJB entity bean persistent storage commit option. It must be one of `A`, `B`, `C` or `D`.

- `A`: the container caches the beans state between transactions. This option assumes that the

container is the only user accessing the persistent store. This assumption allows the container to synchronize the in-memory state from the persistent storage only when absolutely necessary. This occurs before the first business method executes on a found bean or after the bean is passivated and reactivated to serve another business method. This behavior is independent of whether the business method executes inside a transaction context.

- **B:** the container caches the bean state between transactions. However, unlike option **A** the container does not assume exclusive access to the persistent store. Therefore, the container will synchronize the in-memory state at the beginning of each transaction. Thus, business methods executing in a transaction context do not see much benefit from the container caching the bean, whereas business methods executing outside a transaction context (transaction attributes `Never`, `NotSupported` or `Supports`) access the cached (and potentially invalid) state of the bean.
- **C:** the container does not cache bean instances. The in-memory state must be synchronized on every transaction start. For business methods executing outside a transaction the synchronization is still performed, but the `ejbLoad` executes in the same transaction context as that of the caller.
- **D:** is a JBoss-specific commit option which is not described in the EJB specification. It is a lazy read scheme where bean state is cached between transactions as with option **A**, but the state is periodically re-synchronized with that of the persistent store. The default time between reloads is 30 seconds, but may be configured using the `optiond-refresh-rate` element.

#### 30.3.1.3.16. The security-domain element

The `security-domain` element specifies the JNDI name of the object that implements the `org.jboss.security.AuthenticationManager` and `org.jboss.security.RealmMapping` interfaces. It is more typical to specify the `security-domain` under the `jboss` root element so that all EJBs in a given deployment are secured in the same manner. However, it is possible to configure the security domain for each bean configuration.

#### 30.3.1.3.17. cluster-config

The `cluster-config` element allows to specify cluster specific settings for all EJBs that use the container configuration. Specification of the cluster configuration may be done at the container configuration level or at the individual EJB deployment level.

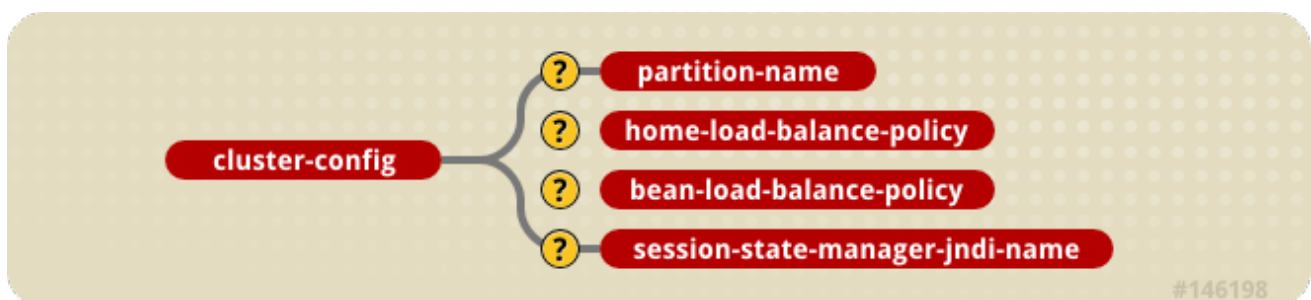

Figure 30.7. The cluster-config and related elements

- **partition-name:** The `partition-name` element indicates where to find the `org.jboss.ha.framework.interfaces.HAPartition` interface to be used by the container to exchange clustering information. This is not the full JNDI name under which `HAPartition` is bound. Rather, it should correspond to the `PartitionName` attribute of the

**ClusterPartitionMBean** service that is managing the desired cluster. The actual JNDI name of the **HAPartition** binding will be formed by appending `/HASessionState/` to the partition-name value. The default value is **DefaultPartition**.

- **home-load-balance-policy**: The `home-load-balance-policy` element indicates the Java class name to be used to load balance calls made on the home proxy. The class must implement the `org.jboss.ha.framework.interface.LoadBalancePolicy` interface. The default policy is `org.jboss.ha.framework.interfaces.RoundRobin`.
- **bean-load-balance-policy**: The `bean-load-balance-policy` element indicates the java class name to be used to load balance calls in the bean proxy. The class must implement the `org.jboss.ha.framework.interface.LoadBalancePolicy` interface. For entity beans and stateful session beans, the default is `org.jboss.ha.framework.interfaces.FirstAvailavble`. For stateless session beans, `org.jboss.ha.framework.interfaces.RoundRobin`.
- **session-state-manager-jndi-name**: The `session-state-manager-jndi-name` element indicates the name of the `org.jboss.ha.framework.interfaces.HASessionState` to be used by the container as a backend for state session management in the cluster. Unlike the partition-name element, this is a JNDI name under which the **HASessionState** implementation is bound. The default location used is `/HASessionState/Default`.

#### 30.3.1.3.18. The depends element

The **depends** element gives a JMX **ObjectName** of a service on which the container or EJB depends. Specification of explicit dependencies on other services avoids having to rely on the deployment order being after the required services are started.

### 30.3.2. Container Plug-in Framework

The JBoss EJB container uses a framework pattern that allows one to change implementations of various aspects of the container behavior. The container itself does not perform any significant work other than connecting the various behavioral components together. Implementations of the behavioral components are referred to as plug-ins, because you can plug in a new implementation by changing a container configuration. Examples of plug-in behavior you may want to change include persistence management, object pooling, object caching, container invokers and interceptors. There are four subclasses of the `org.jboss.ejb.Container` class, each one implementing a particular bean type:

- `org.jboss.ejb.EntityContainer`: handles `javax.ejb.EntityBean` types
- `org.jboss.ejb.StatelessSessionContainer`: handles Stateless `javax.ejb.SessionBean` types
- `org.jboss.ejb.StatefulSessionContainer`: handles Stateful `javax.ejb.SessionBean` types
- `org.jboss.ejb.MessageDrivenContainer` handles `javax.ejb.MessageDrivenBean` types

The EJB containers delegate much of their behavior to components known as container plug-ins. The interfaces that make up the container plug-in points include the following:

- `org.jboss.ejb.ContainerPlugin`
- `org.jboss.ejb.ContainerInvoker`
- `org.jboss.ejb.Interceptor`

- `org.jboss.ejb.InstancePool`
- `org.jboss.ejb.InstanceCache`
- `org.jboss.ejb.EntityPersistenceManager`
- `org.jboss.ejb.EntityPersistenceStore`
- `org.jboss.ejb.StatefulSessionPersistenceManager`

The container's main responsibility is to manage its plug-ins. This means ensuring that the plug-ins have all the information they need to implement their functionality.

### 30.3.2.1. `org.jboss.ejb.ContainerPlugin`

The `ContainerPlugin` interface is the parent interface of all container plug-in interfaces. It provides a callback that allows a container to provide each of its plug-ins a pointer to the container the plug-in is working on behalf of. The `ContainerPlugin` interface is given below.

#### Example 30.4. The `org.jboss.ejb.ContainerPlugin` interface

```
public interface ContainerPlugin
    extends Service, AllowedOperationsFlags
{
    /** co
     * This callback is set by the container so that the plugin
     * may access its container
     *
     * @param con the container which owns the plugin
     */
    public void setContainer(Container con);
}
```

### 30.3.2.2. `org.jboss.ejb.Interceptor`

The `Interceptor` interface enables one to build a chain of method interceptors through which each EJB method invocation must pass. The `Interceptor` interface is given below.

#### Example 30.5. The `org.jboss.ejb.Interceptor` interface

```
import org.jboss.invocation.Invocation;

public interface Interceptor
    extends ContainerPlugin
{
    public void setNext(Interceptor interceptor);
    public Interceptor getNext();
    public Object invokeHome(Invocation mi) throws Exception;
    public Object invoke(Invocation mi) throws Exception;
}
```

All interceptors defined in the container configuration are created and added to the container interceptor chain by the **EJBDeployer**. The last interceptor is not added by the deployer but rather by the container itself because this is the interceptor that interacts with the EJB bean implementation.

The order of the interceptor in the chain is important. The idea behind ordering is that interceptors that are not tied to a particular **EnterpriseContext** instance are positioned before interceptors that interact with caches and pools.

Implementers of the **Interceptor** interface form a linked-list like structure through which the **Invocation** object is passed. The first interceptor in the chain is invoked when an invoker passes a **Invocation** to the container via the JMX bus. The last interceptor invokes the business method on the bean. There are usually on the order of five interceptors in a chain depending on the bean type and container configuration. **Interceptor** semantic complexity ranges from simple to complex. An example of a simple interceptor would be **LoggingInterceptor**, while a complex example is **EntitySynchronizationInterceptor**.

One of the main advantages of an interceptor pattern is flexibility in the arrangement of interceptors. Another advantage is the clear functional distinction between different interceptors. For example, logic for transaction and security is cleanly separated between the **TXInterceptor** and **SecurityInterceptor** respectively.

If any of the interceptors fail, the call is terminated at that point. This is a fail-quickly type of semantic. For example, if a secured EJB is accessed without proper permissions, the call will fail as the **SecurityInterceptor** before any transactions are started or instances caches are updated.

### 30.3.2.3. org.jboss.ejb.InstancePool

An **InstancePool** is used to manage the EJB instances that are not associated with any identity. The pools actually manage subclasses of the **org.jboss.ejb.EnterpriseContext** objects that aggregate un-associated bean instances and related data.

#### Example 30.6. The org.jboss.ejb.InstancePool interface

```
public interface InstancePool
    extends ContainerPlugin
{
    /**
     * Get an instance without identity. Can be used
     * by finders and create-methods, or stateless beans
     *
     * @return Context /w instance
     * @exception RemoteException
     */
    public EnterpriseContext get() throws Exception;

    /** Return an anonymous instance after invocation.
     *
     * @param ctx
     */
    public void free(EnterpriseContext ctx);

    /**
     * Discard an anonymous instance after invocation.
     * This is called if the instance should not be reused,
     * perhaps due to some exception being thrown from it.
     */
}
```

```

    *
    * @param ctx
    */
    public void discard(EnterpriseContext ctx);

    /**
     * Return the size of the pool.
     *
     * @return the size of the pool.
     */
    public int getCurrentSize();

    /**
     * Get the maximum size of the pool.
     *
     * @return the size of the pool.
     */
    public int getMaxSize();
}

```

Depending on the configuration, a container may choose to have a certain size of the pool contain recycled instances, or it may choose to instantiate and initialize an instance on demand.

The pool is used by the `InstanceCache` implementation to acquire free instances for activation, and it is used by interceptors to acquire instances to be used for Home interface methods (create and finder calls).

#### 30.3.2.4. `org.jboss.ejb.InstanceCache`

The container `InstanceCache` implementation handles all EJB-instances that are in an active state, meaning bean instances that have an identity attached to them. Only entity and stateful session beans are cached, as these are the only bean types that have state between method invocations. The cache key of an entity bean is the bean primary key. The cache key for a stateful session bean is the session id.

##### Example 30.7. The `org.jboss.ejb.InstanceCache` interface

```

public interface InstanceCache
    extends ContainerPlugin
{
    /**
     * Gets a bean instance from this cache given the identity.
     * This method may involve activation if the instance is not
     * in the cache.
     * Implementation should have  $O(1)$  complexity.
     * This method is never called for stateless session beans.
     *
     * @param id the primary key of the bean
     * @return the EnterpriseContext related to the given id
     * @exception RemoteException in case of illegal calls
     * (concurrent / reentrant), NoSuchObjectException if
     * the bean cannot be found.
     * @see #release
     */
}

```



```

    public EnterpriseContext get(Object id)
    throws RemoteException, NoSuchObjectException;

    /**
     * Inserts an active bean instance after creation or activation.
     * Implementation should guarantee proper locking and O(1)
    complexity.
     *
     * @param ctx the EnterpriseContext to insert in the cache
     * @see #remove
     */
    public void insert(EnterpriseContext ctx);

    /**
     * Releases the given bean instance from this cache.
     * This method may passivate the bean to get it out of the cache.
     * Implementation should return almost immediately leaving the
     * passivation to be executed by another thread.
     *
     * @param ctx the EnterpriseContext to release
     * @see #get
     */
    public void release(EnterpriseContext ctx);

    /**
     * Removes a bean instance from this cache given the identity.
     * Implementation should have O(1) complexity and guarantee
     * proper locking.
     *
     * @param id the primary key of the bean
     * @see #insert
     */
    public void remove(Object id);

    /**
     * Checks whether an instance corresponding to a particular
     * id is active
     *
     * @param id the primary key of the bean
     * @see #insert
     */
    public boolean isActive(Object id);
}

```

In addition to managing the list of active instances, the **InstanceCache** is also responsible for activating and passivating instances. If an instance with a given identity is requested, and it is not currently active, the **InstanceCache** must use the **InstancePool** to acquire a free instance, followed by the persistence manager to activate the instance. Similarly, if the **InstanceCache** decides to passivate an active instance, it must call the persistence manager to passivate it and release the instance to the **InstancePool**.

### 30.3.2.5. org.jboss.ejb.EntityPersistenceManager

The `EntityPersistenceManager` is responsible for the persistence of EntityBeans. This includes the following:

- Creating an EJB instance in a storage
- Loading the state of a given primary key into an EJB instance
- Storing the state of a given EJB instance
- Removing an EJB instance from storage
- Activating the state of an EJB instance
- Passivating the state of an EJB instance

### Example 30.8. The `org.jboss.ejb.EntityPersistenceManager` interface

```
public interface EntityPersistenceManager
    extends ContainerPlugin
{
    /**
     * Returns a new instance of the bean class or a subclass of the
     * bean class.
     *
     * @return the new instance
     */
    Object createBeanClassInstance() throws Exception;

    /**
     * This method is called whenever an entity is to be created. The
     * persistence manager is responsible for calling the ejbCreate
     method
     * on the instance and to handle the results properly wrt the
     persistent
     * store.
     *
     * @param m the create method in the home interface that was
     * called
     * @param args any create parameters
     * @param instance the instance being used for this create call
     */
    void createEntity(Method m,
        Object[] args,
        EntityEnterpriseContext instance)
        throws Exception;

    /**
     * This method is called whenever an entity is to be created. The
     * persistence manager is responsible for calling the ejbPostCreate
     method
     * on the instance and to handle the results properly wrt the
     persistent
     * store.
     *
     * @param m the create method in the home interface that was
     * called

```

```

    * @param args any create parameters
    * @param instance the instance being used for this create call
    */
void postCreateEntity(Method m,
    Object[] args,
    EntityEnterpriseContext instance)
throws Exception;

/**
 * This method is called when single entities are to be found. The
 * persistence manager must find out whether the wanted instance is
 * available in the persistence store, and if so it shall use the
 * ContainerInvoker plugin to create an EJBObject to the instance,
which
 * is to be returned as result.
 *
 * @param finderMethod the find method in the home interface that
was
 * called
 * @param args any finder parameters
 * @param instance the instance to use for the finder call
 * @return an EJBObject representing the found entity
 */
Object findEntity(Method finderMethod,
    Object[] args,
    EntityEnterpriseContext instance)
throws Exception;

/**
 * This method is called when collections of entities are to be
 * found. The persistence manager must find out whether the wanted
 * instances are available in the persistence store, and if so it
 * shall use the ContainerInvoker plugin to create EJBObjects to
 * the instances, which are to be returned as result.
 *
 * @param finderMethod the find method in the home interface that
was
 * called
 * @param args any finder parameters
 * @param instance the instance to use for the finder call
 * @return an EJBObject collection representing the found
 * entities
 */
Collection findEntities(Method finderMethod,
    Object[] args,
    EntityEnterpriseContext instance)
    throws Exception;

/**
 * This method is called when an entity shall be activated. The
 * persistence manager must call the ejbActivate method on the
 * instance.
 *
 * @param instance the instance to use for the activation
 *
 * @throws RemoteException thrown if some system exception occurs

```

```
 */
void activateEntity(EntityEnterpriseContext instance)
throws RemoteException;

/**
 * This method is called whenever an entity shall be load from the
 * underlying storage. The persistence manager must load the state
 * from the underlying storage and then call ejbLoad on the
 * supplied instance.
 *
 * @param instance the instance to synchronize
 *
 * @throws RemoteException thrown if some system exception occurs
 */
void loadEntity(EntityEnterpriseContext instance)
throws RemoteException;

/**
 * This method is used to determine if an entity should be stored.
 *
 * @param instance the instance to check
 * @return true, if the entity has been modified
 * @throws Exception thrown if some system exception occurs
 */
boolean isModified(EntityEnterpriseContext instance) throws
Exception;

/**
 * This method is called whenever an entity shall be stored to the
 * underlying storage. The persistence manager must call ejbStore
 * on the supplied instance and then store the state to the
 * underlying storage.
 *
 * @param instance the instance to synchronize
 *
 * @throws RemoteException thrown if some system exception occurs
 */
void storeEntity(EntityEnterpriseContext instance)
throws RemoteException;

/**
 * This method is called when an entity shall be passivate. The
 * persistence manager must call the ejbPassivate method on the
 * instance.
 *
 * @param instance the instance to passivate
 *
 * @throws RemoteException thrown if some system exception occurs
 */
void passivateEntity(EntityEnterpriseContext instance)
throws RemoteException;

/**
 * This method is called when an entity shall be removed from the
 * underlying storage. The persistence manager must call ejbRemove
 * on the instance and then remove its state from the underlying
```

```

    * storage.
    *
    * @param instance the instance to remove
    *
    * @throws RemoteException thrown if some system exception occurs
    * @throws RemoveException thrown if the instance could not be
removed
    */
    void removeEntity(EntityEnterpriseContext instance)
    throws RemoteException, RemoveException;
}

```

### 30.3.2.6. The org.jboss.ejb.EntityPersistenceStore interface

As per the EJB 2.1 specification, JBoss supports two entity bean persistence semantics: container managed persistence (CMP) and bean managed persistence (BMP). The CMP implementation uses an implementation of the `org.jboss.ejb.EntityPersistenceStore` interface. By default this is the `org.jboss.ejb.plugins.cmp.jdbc.JDBCStoreManager` which is the entry point for the CMP2 persistence engine. The `EntityPersistenceStore` interface is shown below.

#### Example 30.9. The org.jboss.ejb.EntityPersistenceStore interface

```

public interface EntityPersistenceStore
    extends ContainerPlugin
{
    /**
     * Returns a new instance of the bean class or a subclass of the
     * bean class.
     *
     * @return the new instance
     *
     * @throws Exception
     */
    Object createBeanClassInstance()
        throws Exception;

    /**
     * Initializes the instance context.
     *
     * <p>This method is called before createEntity, and should
     * reset the value of all cmpFields to 0 or null.
     *
     * @param ctx
     *
     * @throws RemoteException
     */
    void initEntity(EntityEnterpriseContext ctx);

    /**
     * This method is called whenever an entity is to be created. The
     * persistence manager is responsible for handling the results
     * properly wrt the persistent store.
     *
     * @param m the create method in the home interface that was

```

```

    * called
    * @param args any create parameters
    * @param instance the instance being used for this create call
    * @return The primary key computed by CMP PM or null for BMP
    *
    * @throws Exception
    */
Object createEntity(Method m,
Object[] args,
EntityEnterpriseContext instance)
    throws Exception;

/**
 * This method is called when single entities are to be found. The
 * persistence manager must find out whether the wanted instance
 * is available in the persistence store, if so it returns the
 * primary key of the object.
 *
 * @param finderMethod the find method in the home interface that
was
    * called
    * @param args any finder parameters
    * @param instance the instance to use for the finder call
    * @return a primary key representing the found entity
    *
    * @throws RemoteException thrown if some system exception occurs
    * @throws FinderException thrown if some heuristic problem occurs
    */
Object findEntity(Method finderMethod,
    Object[] args,
    EntityEnterpriseContext instance)
    throws Exception;

/**
 * This method is called when collections of entities are to be
 * found. The persistence manager must find out whether the wanted
 * instances are available in the persistence store, and if so it
 * must return a collection of primaryKeys.
 *
 * @param finderMethod the find method in the home interface that
was
    * called
    * @param args any finder parameters
    * @param instance the instance to use for the finder call
    * @return an primary key collection representing the found
    * entities
    *
    * @throws RemoteException thrown if some system exception occurs
    * @throws FinderException thrown if some heuristic problem occurs
    */
Collection findEntities(Method finderMethod,
    Object[] args,
    EntityEnterpriseContext instance)
    throws Exception;

/**

```

```

    * This method is called when an entity shall be activated.
    *
    * <p>With the PersistenceManager factorization most EJB
    * calls should not exists However this calls permits us to
    * introduce optimizations in the persistence store. Particularly
    * the context has a "PersistenceContext" that a PersistenceStore
    * can use (JAWS does for smart updates) and this is as good a
    * callback as any other to set it up.
    * @param instance the instance to use for the activation
    *
    * @throws RemoteException thrown if some system exception occurs
    */
void activateEntity(EntityEnterpriseContext instance)
    throws RemoteException;

/**
 * This method is called whenever an entity shall be load from the
 * underlying storage. The persistence manager must load the state
 * from the underlying storage and then call ejbLoad on the
 * supplied instance.
 *
 * @param instance the instance to synchronize
 *
 * @throws RemoteException thrown if some system exception occurs
 */
void loadEntity(EntityEnterpriseContext instance)
    throws RemoteException;

/**
 * This method is used to determine if an entity should be stored.
 *
 * @param instance the instance to check
 * @return true, if the entity has been modified
 * @throws Exception thrown if some system exception occurs
 */
boolean isModified(EntityEnterpriseContext instance)
    throws Exception;

/**
 * This method is called whenever an entity shall be stored to the
 * underlying storage. The persistence manager must call ejbStore
 * on the supplied instance and then store the state to the
 * underlying storage.
 *
 * @param instance the instance to synchronize
 *
 * @throws RemoteException thrown if some system exception occurs
 */
void storeEntity(EntityEnterpriseContext instance)
    throws RemoteException;

/**
 * This method is called when an entity shall be passivate. The
 * persistence manager must call the ejbPassivate method on the
 * instance.
 *

```

```

    * <p>See the activate discussion for the reason for
    * exposing EJB callback * calls to the store.
    *
    * @param instance the instance to passivate
    *
    * @throws RemoteException thrown if some system exception occurs
    */
    void passivateEntity(EntityEnterpriseContext instance)
        throws RemoteException;

    /**
     * This method is called when an entity shall be removed from the
     * underlying storage. The persistence manager must call ejbRemove
     * on the instance and then remove its state from the underlying
     * storage.
     *
     * @param instance the instance to remove
     *
     * @throws RemoteException thrown if some system exception occurs
     * @throws RemoveException thrown if the instance could not be
    removed
     */
    void removeEntity(EntityEnterpriseContext instance)
        throws RemoteException, RemoveException;
}

```

The default BMP implementation of the `EntityPersistenceManager` interface is `org.jboss.ejb.plugins.BMPPersistenceManager`. The BMP persistence manager is fairly simple since all persistence logic is in the entity bean itself. The only duty of the persistence manager is to perform container callbacks.

### 30.3.2.7. `org.jboss.ejb.StatefulSessionPersistenceManager`

The `StatefulSessionPersistenceManager` is responsible for the persistence of stateful `SessionBeans`. This includes the following:

- Creating stateful sessions in a storage
- Activating stateful sessions from a storage
- Passivating stateful sessions to a storage
- Removing stateful sessions from a storage

The `StatefulSessionPersistenceManager` interface is shown below.

#### Example 30.10. The `org.jboss.ejb.StatefulSessionPersistenceManager` interface

```

public interface StatefulSessionPersistenceManager
    extends ContainerPlugin
{
    public void createSession(Method m, Object[] args,
        StatefulSessionEnterpriseContext ctx)
        throws Exception;
}

```



```

    public void activateSession(StatefulSessionEnterpriseContext ctx)
    throws RemoteException;

    public void passivateSession(StatefulSessionEnterpriseContext ctx)
    throws RemoteException;

    public void removeSession(StatefulSessionEnterpriseContext ctx)
    throws RemoteException, RemoveException;

    public void removePassivated(Object key);
}

```

The default implementation of the `StatefulSessionPersistenceManager` interface is `org.jboss.ejb.plugins.StatefulSessionFilePersistenceManager`. As its name implies, `StatefulSessionFilePersistenceManager` utilizes the file system to persist stateful session beans. More specifically, the persistence manager serializes beans in a flat file whose name is composed of the bean name and session id with a `.ser` extension. The persistence manager restores a bean's state during activation and respectively stores its state during passivation from the bean's `.ser` file.

## 30.4. ENTITY BEAN LOCKING AND DEADLOCK DETECTION

This section provides information on what entity bean locking is and how entity beans are accessed and locked within JBoss. It also describes the problems you may encounter as you use entity beans within your system and how to combat these issues. Deadlocking is formally defined and examined. And, finally, we walk you through how to fine tune your system in terms of entity bean locking.

### 30.4.1. Why JBoss Needs Locking

Locking is about protecting the integrity of your data. Sometimes you need to be sure that only one user can update critical data at one time. Sometimes, access to sensitive objects in your system need to be serialized so that data is not corrupted by concurrent reads and writes. Databases traditionally provide this sort of functionality with transactional scopes and table and row locking facilities.

Entity beans are a great way to provide an object-oriented interface to relational data. Beyond that, they can improve performance by taking the load off of the database through caching and delaying updates until absolutely needed so that the database efficiency can be maximized. But, with caching, data integrity is a problem, so some form of application server level locking is needed for entity beans to provide the transaction isolation properties that you are used to with traditional databases.

### 30.4.2. Entity Bean Lifecycle

With the default configuration of JBoss there is only one active instance of a given entity bean in memory at one time. This applies for every cache configuration and every type of `commit-option`. The lifecycle for this instance is different for every `commit-option` though.

- For commit option *A*, this instance is cached and used between transactions.
- For commit option *B*, this instance is cached and used between transactions, but is marked as dirty at the end of a transaction. This means that at the start of a new transaction `ejbLoad` must be called.

- For commit option *C*, this instance is marked as dirty, released from the cache, and marked for passivation at the end of a transaction.
- For commit option *D*, a background refresh thread periodically calls `ejbLoad` on stale beans within the cache. Otherwise, this option works in the same way as *A*.

When a bean is marked for passivation, the bean is placed in a passivation queue. Each entity bean container has a passivation thread that periodically passivates beans that have been placed in the passivation queue. A bean is pulled out of the passivation queue and reused if the application requests access to a bean of the same primary key.

On an exception or transaction rollback, the entity bean instance is thrown out of cache entirely. It is not put into the passivation queue and is not reused by an instance pool. Except for the passivation queue, there is no entity bean instance pooling.

### 30.4.3. Default Locking Behavior

Entity bean locking is totally decoupled from the entity bean instance. The logic for locking is totally isolated and managed in a separate lock object. Because there is only one allowed instance of a given entity bean active at one time, JBoss employs two types of locks to ensure data integrity and to conform to the EJB spec.

- **Method Lock:** The method lock ensures that only one thread of execution at a time can invoke on a given Entity Bean. This is required by the EJB spec.
- **Transaction Lock:** A transaction lock ensures that only one transaction at a time has access to a give Entity Bean. This ensures the ACID properties of transactions at the application server level. Since, by default, there is only one active instance of any given Entity Bean at one time, JBoss must protect this instance from dirty reads and dirty writes. So, the default entity bean locking behavior will lock an entity bean within a transaction until it completes. This means that if any method at all is invoked on an entity bean within a transaction, no other transaction can have access to this bean until the holding transaction commits or is rolled back.

### 30.4.4. Pluggable Interceptors and Locking Policy

We saw that the basic entity bean lifecycle and behavior is defined by the container configuration defined in `standardjboss.xml` descriptor. Let us look at the `container-interceptors` definition for the *Standard CMP 2.x EntityBean* configuration.

```
<container-interceptors>
<interceptor>org.jboss.ejb.plugins.ProxyFactoryFinderInterceptor</interceptor>
  <interceptor>org.jboss.ejb.plugins.LogInterceptor</interceptor>
  <interceptor>org.jboss.ejb.plugins.SecurityInterceptor</interceptor>
  <interceptor>org.jboss.ejb.plugins.TxInterceptorCMT</interceptor>
<interceptor>org.jboss.ejb.plugins.CallValidationInterceptor</interceptor>
  <interceptor
metricsEnabled="true">org.jboss.ejb.plugins.MetricsInterceptor</interceptor>
<interceptor>org.jboss.ejb.plugins.EntityCreationInterceptor</interceptor>
  <interceptor>org.jboss.ejb.plugins.EntityLockInterceptor</interceptor>
<interceptor>org.jboss.ejb.plugins.EntityInstanceInterceptor</interceptor>
```

```

<interceptor>org.jboss.ejb.plugins.EntityReentranceInterceptor</interceptor>
<interceptor>org.jboss.resource.connectionmanager.CachedConnectionInterceptor</interceptor>
<interceptor>org.jboss.ejb.plugins.EntitySynchronizationInterceptor</interceptor>
<interceptor>org.jboss.ejb.plugins.cmp.jdbc.JDBCRelationInterceptor</interceptor>
</container-interceptors>

```

The interceptors shown above define most of the behavior of the entity bean. Below is an explanation of the interceptors that are relevant to this section.

- **EntityLockInterceptor:** This interceptor's role is to schedule any locks that must be acquired before the invocation is allowed to proceed. This interceptor is very lightweight and delegates all locking behavior to a pluggable locking policy.
- **EntityInstanceInterceptor:** The job of this interceptor is to find the entity bean within the cache or create a new one. This interceptor also ensures that there is only one active instance of a bean in memory at one time.
- **EntitySynchronizationInterceptor:** The role of this interceptor is to synchronize the state of the cache with the underlying storage. It does this with the `ejbLoad` and `ejbStore` semantics of the EJB specification. In the presence of a transaction this is triggered by transaction demarcation. It registers a callback with the underlying transaction monitor through the JTA interfaces. If there is no transaction the policy is to store state upon returning from invocation. The synchronization polices *A*, *B* and *C* of the specification are taken care of here as well as the JBoss specific commit-option *D*.

### 30.4.5. Deadlock

Finding deadlock problems and resolving them is the topic of this section. We will describe what deadlocking MBeans, how you can detect it within your application, and how you can resolve deadlocks. Deadlock can occur when two or more threads have locks on shared resources. [Figure 30.8, “Deadlock definition example”](#) illustrates a simple deadlock scenario. Here, **Thread 1** has the lock for **Bean A**, and **Thread 2** has the lock for **Bean B**. At a later time, **Thread 1** tries to lock **Bean B** and blocks because **Thread 2** has it. Likewise, as **Thread 2** tries to lock **A** it also blocks because **Thread 1** has the lock. At this point both threads are deadlocked waiting for access to the resource already locked by the other thread.

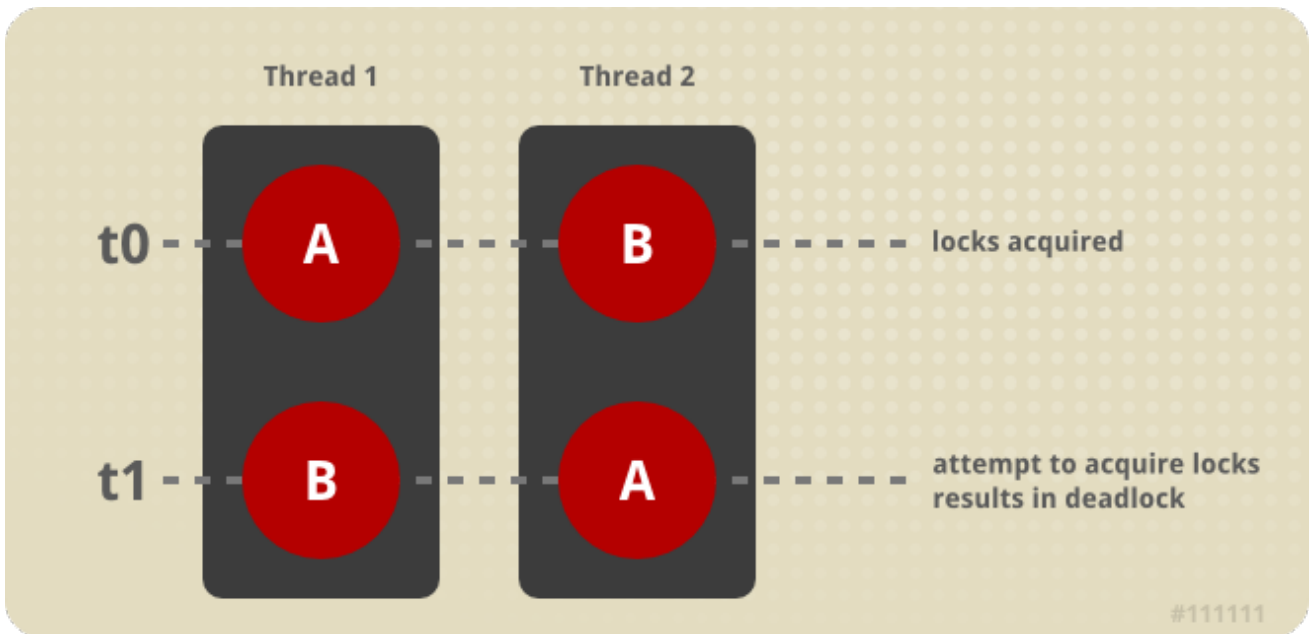

Figure 30.8. Deadlock definition example

The default locking policy of JBoss is to lock an Entity bean when an invocation occurs in the context of a transaction until the transaction completes. Because of this, it is very easy to encounter deadlock if you have long running transactions that access many entity beans, or if you are not careful about ordering the access to them. Various techniques and advanced configurations can be used to avoid deadlocking problems. They are discussed later in this section.

### 30.4.5.1. Deadlock Detection

Fortunately, JBoss is able to perform deadlock detection. JBoss holds a global internal graph of waiting transactions and what transactions they are blocking on. Whenever a thread determines that it cannot acquire an entity bean lock, it figures out what transaction currently holds the lock on the bean and add itself to the blocked transaction graph. An example of what the graph may look like is given in Table 30.1, “An example blocked transaction table”.

Table 30.1. An example blocked transaction table

Blocking TX	Tx that holds needed lock
Tx1	Tx2
Tx3	Tx4
Tx4	Tx1

Before the thread actually blocks it tries to detect whether there is deadlock problem. It does this by traversing the block transaction graph. As it traverses the graph, it keeps track of what transactions are blocked. If it sees a blocked node more than once in the graph, then it knows there is deadlock and will throw an `ApplicationDeadlockException`. This exception will cause a transaction rollback which will cause all locks that transaction holds to be released.

### 30.4.5.2. Catching ApplicationDeadlockException

Since JBoss can detect application deadlock, you should write your application so that it can retry a

transaction if the invocation fails because of the `ApplicationDeadlockException`. Unfortunately, this exception can be deeply embedded within a `RemoteException`, so you have to search for it in your catch block. For example:

```
try {
    // ...
} catch (RemoteException ex) {
    Throwable cause = null;
    RemoteException rex = ex;
    while (rex.detail != null) {
        cause = rex.detail;
        if (cause instanceof ApplicationDeadlockException) {
            // ... We have deadlock, force a retry of the transaction.
            break;
        }
        if (cause instanceof RemoteException) {
            rex = (RemoteException)cause;
        }
    }
}
```

### 30.4.5.3. Viewing Lock Information

The `EntityLockMonitor` MBean service allows one to view basic locking statistics as well as printing out the state of the transaction locking table. To enable this monitor uncomment its configuration in the `conf/jboss-service.xml`:

```
<mbean code="org.jboss.monitor.EntityLockMonitor"
       name="jboss.monitor:name=EntityLockMonitor"/>
```

The `EntityLockMonitor` has no configurable attributes. It does have the following read-only attributes:

- **MedianWaitTime:** The median value of all times threads had to wait to acquire a lock.
- **AverageContenders:** The ratio of the total number of contentions to the sum of all threads that had to wait for a lock.
- **TotalContentions:** The total number of threads that had to wait to acquire the transaction lock. This happens when a thread attempts to acquire a lock that is associated with another transaction
- **MaxContenders:** The maximum number of threads that were waiting to acquire the transaction lock.

It also has the following operations:

- **clearMonitor:** This operation resets the lock monitor state by zeroing all counters.
- **printLockMonitor:** This operation prints out a table of all EJB locks that lists the `ejbName` of the bean, the total time spent waiting for the lock, the count of times the lock was waited on and the number of transactions that timed out waiting for the lock.

### 30.4.6. Advanced Configurations and Optimizations

The default locking behavior of entity beans can cause deadlock. Since access to an entity bean locks the bean into the transaction, this also can present a huge performance/throughput problem for your application. This section walks through various techniques and configurations that you can use to optimize performance and reduce the possibility of deadlock.

### 30.4.6.1. Short-lived Transactions

Make your transactions as short-lived and fine-grained as possible. The shorter the transaction you have, the less likelihood you will have concurrent access collisions and your application throughput will go up.

### 30.4.6.2. Ordered Access

Ordering the access to your entity beans can help lessen the likelihood of deadlock. This means making sure that the entity beans in your system are always accessed in the same exact order. In most cases, user applications are just too complicated to use this approach and more advanced configurations are needed.

### 30.4.6.3. Read-Only Beans

Entity beans can be marked as read-only. When a bean is marked as read-only, it never takes part in a transaction. This means that it is never transactionally locked. Using commit-option *D* with this option is sometimes very useful when your read-only bean's data is sometimes updated by an external source.

To mark a bean as read-only, use the `read-only` flag in the `jboss.xml` deployment descriptor.

#### Example 30.11. Marking an entity bean read-only using `jboss.xml`

```
<jboss>
  <enterprise-beans>
    <entity>
      <ejb-name>MyEntityBean</ejb-name>
      <jndi-name>MyEntityHomeRemote</jndi-name>
      <read-only>True</read-only>
    </entity>
  </enterprise-beans>
</jboss>
```

### 30.4.6.4. Explicitly Defining Read-Only Methods

After reading and understanding the default locking behavior of entity beans, you are probably wondering, "Why lock the bean if its not modifying the data?" JBoss allows you to define what methods on your entity bean are read only so that it will not lock the bean within the transaction if only these types of methods are called. You can define these read only methods within a `jboss.xml` deployment descriptor. Wildcards are allowed for method names. The following is an example of declaring all getter methods and the `anotherReadOnlyMethod` as read-only.

#### Example 30.12. Defining entity bean methods as read only

```
<jboss>
  <enterprise-beans>
    <entity>
```

```

    <ejb-name>nextgen.EnterpriseEntity</ejb-name>
    <jndi-name>nextgen.EnterpriseEntity</jndi-name>
    <method-attributes>
      <method>
        <method-name>get*</method-name>
        <read-only>>true</read-only>
      </method>
      <method>
        <method-name>anotherReadOnlyMethod</method-name>
        <read-only>>true</read-only>
      </method>
    </method-attributes>
  </entity>
</enterprise-beans>
</jboss>

```

### 30.4.6.5. Instance Per Transaction Policy

The Instance Per Transaction policy is an advanced configuration that can totally wipe away deadlock and throughput problems caused by JBoss's default locking policy. The default Entity Bean locking policy is to only allow one active instance of a bean. The Instance Per Transaction policy breaks this requirement by allocating a new instance of a bean per transaction and dropping this instance at the end of the transaction. Because each transaction has its own copy of the bean, there is no need for transaction based locking.

This option does sound great but does have some drawbacks right now. First, the transactional isolation behavior of this option is equivalent to **READ\_COMMITTED**. This can create repeatable reads when they are not desired. In other words, a transaction could have a copy of a stale bean. Second, this configuration option currently requires commit-option *B* or *C* which can be a performance drain since an `ejbLoad` must happen at the beginning of the transaction. But, if your application currently requires commit-option *B* or *C* anyways, then this is the way to go. The JBoss developers are currently exploring ways to allow commit-option *A* as well (which would allow the use of caching for this option).

JBoss has container configurations named **Instance Per Transaction CMP 2.x EntityBean** and **Instance Per Transaction BMP EntityBean** defined in the `standardjboss.xml` that implement this locking policy. To use this configuration, you just have to reference the name of the container configuration to use with your bean in the `jboss.xml` deployment descriptor as show below.

**Example 30.13. An example of using the Instance Per Transaction policy.**

```

<jboss>
  <enterprise-beans>
    <entity>
      <ejb-name>MyCMP2Bean</ejb-name>
      <jndi-name>MyCMP2</jndi-name>
      <configuration-name>
        Instance Per Transaction CMP 2.x EntityBean
      </configuration-name>
    </entity>
    <entity>
      <ejb-name>MyBMPBean</ejb-name>
      <jndi-name>MyBMP</jndi-name>
      <configuration-name>
        Instance Per Transaction BMP EntityBean
      </configuration-name>
    </entity>
  </enterprise-beans>
</jboss>

```

```
        </configuration-name>
    </entity>
</enterprise-beans>
</jboss>
```

### 30.4.7. Running Within a Cluster

Currently there is no distributed locking capability for entity beans within the cluster. This functionality has been delegated to the database and must be supported by the application developer. For clustered entity beans, it is suggested to use commit-option *B* or *C* in combination with a row locking mechanism. For CMP, there is a row-locking configuration option. This option will use a SQL `select for update` when the bean is loaded from the database. With commit-option *B* or *C*, this implements a transactional lock that can be used across the cluster. For BMP, you must explicitly implement the select for update invocation within the BMP's `ejbLoad` method.

### 30.4.8. Troubleshooting

This section will describe some common locking problems and their solution.

#### 30.4.8.1. Locking Behavior Not Working

Many JBoss users observe that locking does not seem to be working and see concurrent access to their beans, and thus dirty reads. Here are some common reasons for this:

- If you have custom **container - configurations**, make sure you have updated these configurations.
- Make absolutely sure that you have implemented `equals` and `hashCode` correctly from custom/complex primary key classes.
- Make absolutely sure that your custom/complex primary key classes serialize correctly. One common mistake is assuming that member variable initializations will be executed when a primary key is unmarshaled.

#### 30.4.8.2. IllegalStateException

An `IllegalStateException` with the message "removing bean lock and it has tx set!" usually means that you have not implemented `equals` and/or `hashCode` correctly for your custom/complex primary key class, or that your primary key class is not implemented correctly for serialization.

#### 30.4.8.3. Hangs and Transaction Timeouts

One long outstanding bug of JBoss is that on a transaction timeout, that transaction is only marked for a rollback and not actually rolled back. This responsibility is delegated to the invocation thread. This can cause major problems if the invocation thread hangs indefinitely since things like entity bean locks will never be released. The solution to this problem is not a good one. You really just need to avoid doing stuff within a transaction that could hang indefinitely. One common mistake is making connections across the internet or running a web-crawler within a transaction.

## 30.5. EJB TIMER CONFIGURATION

The J2EE timer service allows for any EJB object to register for a timer callback either at a designated



time in the future. Timer events can be used for auditing, reporting or other cleanup tasks that need to happen at some given time in the future. Timer events are intended to be persistent and should be executed even in the event of a server failure. Coding to EJB timers is a standard part of the J2EE specification, so we will not explore the programming model. We will, instead, look at the configuration of the timer service in JBoss so that you can understand how to make timers work best in your environment

The EJB timer service is configured by several related MBeans in the `ejb-deployer.xml` file. The primary MBean is the `EJBTimerService` MBean.

```
<mbean code="org.jboss.ejb.txtimer.EJBTimerServiceImpl"
name="jboss.ejb:service=EJBTimerService">
  <attribute
name="RetryPolicy">jboss.ejb:service=EJBTimerService,retryPolicy=fixedDelay</attribute>
  <attribute
name="PersistencePolicy">jboss.ejb:service=EJBTimerService,persistencePolicy=database</attribute>
  <attribute
name="TimerIdGeneratorClassName">org.jboss.ejb.txtimer.BigIntegerTimerIdGenerator</attribute>
  <attribute
name="TimedObjectInvokerClassName">org.jboss.ejb.txtimer.TimedObjectInvokerImpl</attribute>
</mbean>
```

The `EJBTimerService` has the following configurable attributes:

- **RetryPolicy:** This is name of the MBean that implements the retry policy. The MBean must support the `org.jboss.ejb.txtimer.RetryPolicy` interface. JBoss provides one implementation, `FixedDelayRetryPolicy`, which will be described later.
- **PersistencePolicy:** This is the name of the MBean that implements the persistence strategy for saving timer events. The MBean must support the `org.jboss.ejb.txtimer.PersistencePolicy` interface. JBoss provides two implementations, `NoopPersistencePolicy` and `DatabasePersistencePolicy`, which will be described later.
- **TimerIdGeneratorClassName:** This is the name of a class that provides the timer ID generator strategy. This class must implement the `org.jboss.ejb.txtimer.TimerIdGenerator` interface. JBoss provides the `org.jboss.ejb.txtimer.BigIntegerTimerIdGenerator` implementation.
- **TimedObjectInvokerClassname:** This is the name of a class that provides the timer method invocation strategy. This class must implement the `org.jboss.ejb.txtimer.TimedObjectInvoker` interface. JBoss provides the `org.jboss.ejb.txtimer.TimedObjectInvokerImpl` implementation.

The retry policy MBean definition used is shown here:

```
<mbean code="org.jboss.ejb.txtimer.FixedDelayRetryPolicy"
name="jboss.ejb:service=EJBTimerService,retryPolicy=fixedDelay">
  <attribute name="Delay">100</attribute>
</mbean>
```

The retry policy takes one configuration value:

- **Delay:** This is the delay (ms) before retrying a failed timer execution. The default delay is 100ms.

If EJB timers do not need to be persisted, the **NoopPersistence** policy can be used. This MBean is commented out by default, but when enabled will look like this:

```
<mbean code="org.jboss.ejb.txtimer.NoopPersistencePolicy"
      name="jboss.ejb:service=EJBTimerService,persistencePolicy=noop"/>
```

Most applications that use timers will want timers to be persisted. For that the **DatabasePersistencePolicy** MBean should be used.

```
<mbean code="org.jboss.ejb.txtimer.DatabasePersistencePolicy"
      name="jboss.ejb:service=EJBTimerService,persistencePolicy=database">
  <!-- DataSource JNDI name -->
  <depends optional-attribute-
name="DataSource">jboss.jca:service=DataSourceBinding,name=DefaultDS</depe
nds>
  <!-- The plugin that handles database persistence -->
  <attribute
name="DatabasePersistencePlugin">org.jboss.ejb.txtimer.GeneralPurposeDatab
asePersistencePlugin</attribute>
</mbean>
```

- **DataSource:** This is the MBean for the DataSource that timer data will be written to.
- **DatabasePersistencePlugin:** This is the name of the class that implements the persistence strategy. This should be **org.jboss.ejb.txtimer.GeneralPurposeDatabasePersistencePlugin**.

## CHAPTER 31. THE CMP ENGINE

This chapter will explore the use of container managed persistence (CMP) in JBoss. We will assume a basic familiarity the EJB CMP model and focus on the operation of the JBoss CMP engine. Specifically, we will look at how to configure and optimize CMP applications on JBoss. For more introductory coverage of basic CMP concepts, we recommend *Enterprise Java Beans, Fourth Edition*(O'Reilly 2004).

### 31.1. EXAMPLE CODE

This chapter is example-driven. We will work with the crime portal application which stores information about imaginary criminal organizations. The data model we will be working with is shown in [Figure 31.1](#), “The crime portal example classes”.

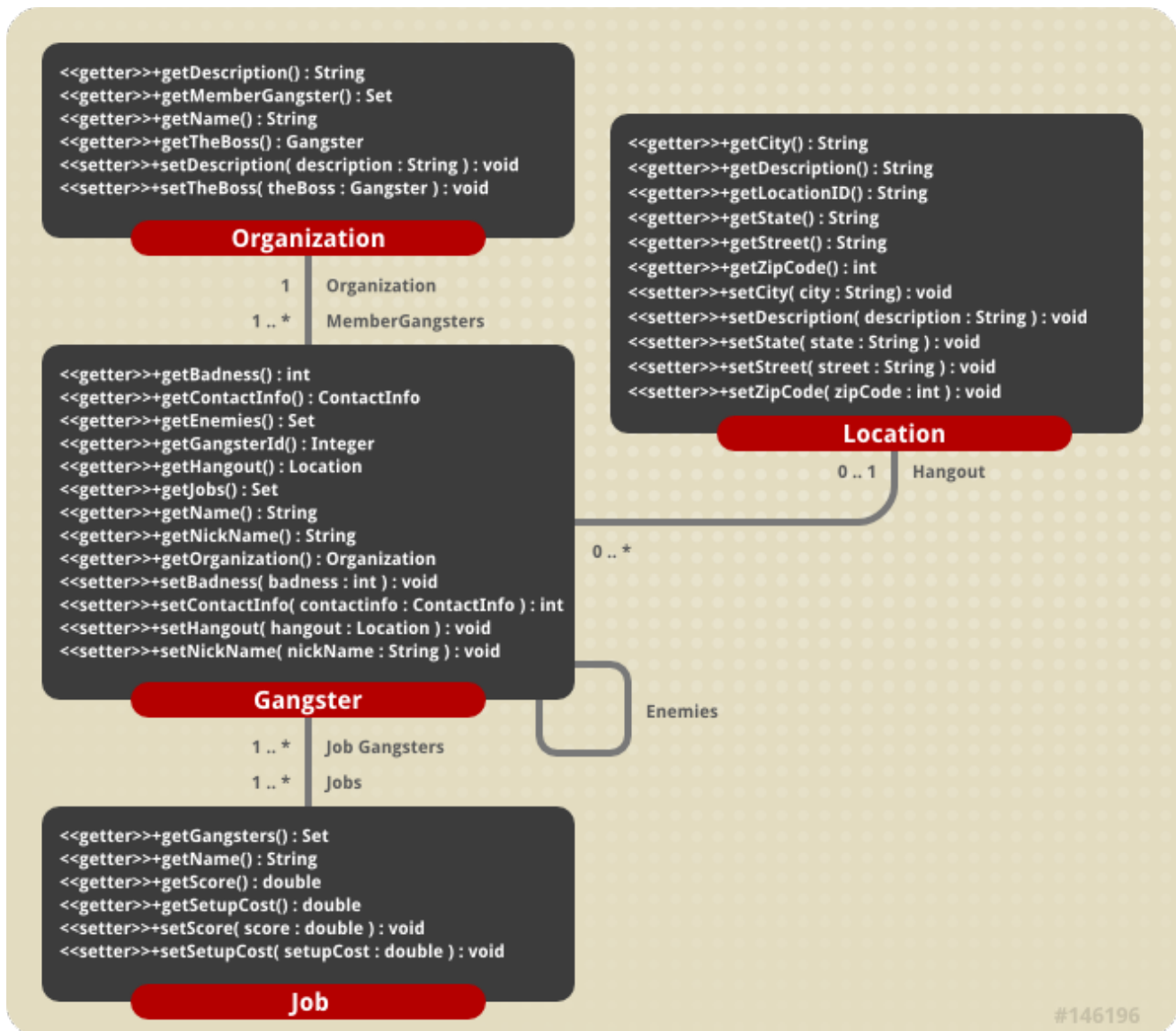

Figure 31.1. The crime portal example classes

The source code for the crime portal is available in the `src/main/org/jboss/cmp2` directory of the example code. To build the example code, run Ant as shown below

```
[examples]$ ant -Dchap=cmp2 config
```

This command builds and deploys the application to the server. When you start your server, or if it is already running, you should see the following deployment messages:

```

15:46:36,704 INFO [OrganizationBean$Proxy] Creating organization Yakuza,
Japanese Gangsters
15:46:36,790 INFO [OrganizationBean$Proxy] Creating organization Mafia,
Italian Bad Guys
15:46:36,797 INFO [OrganizationBean$Proxy] Creating organization Triads,
Kung Fu Movie Extras
15:46:36,877 INFO [GangsterBean$Proxy] Creating Gangster 0 'Bodyguard'
Yojimbo
15:46:37,003 INFO [GangsterBean$Proxy] Creating Gangster 1 'Master'
Takeshi
15:46:37,021 INFO [GangsterBean$Proxy] Creating Gangster 2 'Four finger'
Yuriko
15:46:37,040 INFO [GangsterBean$Proxy] Creating Gangster 3 'Killer' Chow
15:46:37,106 INFO [GangsterBean$Proxy] Creating Gangster 4 'Lightning'
Shogi
15:46:37,118 INFO [GangsterBean$Proxy] Creating Gangster 5 'Pizza-Face'
Valentino
15:46:37,133 INFO [GangsterBean$Proxy] Creating Gangster 6 'Toothless'
Toni
15:46:37,208 INFO [GangsterBean$Proxy] Creating Gangster 7 'Godfather'
Corleone
15:46:37,238 INFO [JobBean$Proxy] Creating Job 10th Street Jeweler Heist
15:46:37,247 INFO [JobBean$Proxy] Creating Job The Greate Train Robbery
15:46:37,257 INFO [JobBean$Proxy] Creating Job Cheap Liquor Snatch and
Grab

```

Since the beans in the examples are configured to have their tables removed on undeployment, anytime you restart the server you need to rerun the config target to reload the example data and re-deploy the application.

### 31.1.1. Enabling CMP Debug Logging

In order to get meaningful feedback from the chapter tests, increase the log level of the CMP subsystem before running the test. To enable debug logging add the following category to your `log4j.xml` file:

```

<category name="org.jboss.ejb.plugins.cmp">
  <priority value="DEBUG"/>
</category>

```

In addition to this, it is necessary to decrease the threshold on the **CONSOLE** appender to allow debug level messages to be logged to the console. The following changes also need to be applied to the `log4j.xml` file.

```

<appender name="CONSOLE" class="org.apache.log4j.ConsoleAppender">
  <errorHandler class="org.jboss.logging.util.OnlyOnceErrorHandler"/>
  <param name="Target" value="System.out"/>
  <param name="Threshold" value="DEBUG" />

  <layout class="org.apache.log4j.PatternLayout">
    <!-- The default pattern: Date Priority [Category] Message\n -->
    <param name="ConversionPattern" value="%d{ABSOLUTE} %-5p [%c{1}]
%m%n"/>
  </layout>
</appender>

```

To see the full workings of the CMP engine you would need to enable the custom **TRACE** level priority on the `org.jboss.ejb.plugins.cmp` category as shown here:

```
<category name="org.jboss.ejb.plugins.cmp">
  <priority value="TRACE" class="org.jboss.logging.XLevel"/>
</category>
```

### 31.1.2. Running the examples

The first test target illustrates a number of the customization features that will be discussed throughout this chapter. To run these tests execute the following ant target:

```
[examples]$ ant -Dchap=cmp2 -Dex=test run-example
```

```
22:30:09,862 DEBUG [OrganizationEJB#findByPrimaryKey] Executing SQL:
SELECT t0_OrganizationEJ
B.name FROM ORGANIZATION t0_OrganizationEJB WHERE
t0_OrganizationEJB.name=?
22:30:09,927 DEBUG [OrganizationEJB] Executing SQL: SELECT desc, the_boss
FROM ORGANIZATION W
HERE (name=?)
22:30:09,931 DEBUG [OrganizationEJB] load relation SQL: SELECT id FROM
GANGSTER WHERE (organi
zation=?)
22:30:09,947 DEBUG [StatelessSessionContainer] Useless invocation of
remove() for stateless s
ession bean
22:30:10,086 DEBUG [GangsterEJB#findBadDudes_ejbql] Executing SQL: SELECT
t0_g.id FROM GANGST
ER t0_g WHERE (t0_g.badness > ?)
22:30:10,097 DEBUG [GangsterEJB#findByPrimaryKey] Executing SQL: SELECT
t0_GangsterEJB.id FRO
M GANGSTER t0_GangsterEJB WHERE t0_GangsterEJB.id=?
22:30:10,102 DEBUG [GangsterEJB#findByPrimaryKey] Executing SQL: SELECT
t0_GangsterEJB.id FRO
M GANGSTER t0_GangsterEJB WHERE t0_GangsterEJB.id=?
```

These tests exercise various finders, selectors and object to table mapping issues. We will refer to the tests throughout the chapter.

The other main target runs a set of tests to demonstrate the optimized loading configurations presented in [Section 31.7, “Optimized Loading”](#). Now that the logging is setup correctly, the read-ahead tests will display useful information about the queries performed. Note that you do not have to restart the server for it to recognize the changes to the `log4j.xml` file, but it may take a minute or so. The following shows the actual execution of the readahead client:

```
[examples]$ ant -Dchap=cmp2 -Dex=readahead run-example
```

When the readahead client is executed, all of the SQL queries executed during the test are displayed in the server console. The important items of note when analyzing the output are the number of queries executed, the columns selected, and the number of rows loaded. The following shows the read-ahead none portion of the server console output from readahead:

```

22:44:31,570 INFO [ReadAheadTest]
#####
### read-ahead none
###
22:44:31,582 DEBUG [GangsterEJB#findAll_none] Executing SQL: SELECT
t0_g.id FROM GANGSTER t0_
g ORDER BY t0_g.id ASC
22:44:31,604 DEBUG [GangsterEJB] Executing SQL: SELECT name, nick_name,
badness, organization
, hangout FROM GANGSTER WHERE (id=?)
22:44:31,615 DEBUG [GangsterEJB] Executing SQL: SELECT name, nick_name,
badness, organization
, hangout FROM GANGSTER WHERE (id=?)
22:44:31,622 DEBUG [GangsterEJB] Executing SQL: SELECT name, nick_name,
badness, organization
, hangout FROM GANGSTER WHERE (id=?)
22:44:31,628 DEBUG [GangsterEJB] Executing SQL: SELECT name, nick_name,
badness, organization
, hangout FROM GANGSTER WHERE (id=?)
22:44:31,635 DEBUG [GangsterEJB] Executing SQL: SELECT name, nick_name,
badness, organization
, hangout FROM GANGSTER WHERE (id=?)
22:44:31,644 DEBUG [GangsterEJB] Executing SQL: SELECT name, nick_name,
badness, organization
, hangout FROM GANGSTER WHERE (id=?)
22:44:31,649 DEBUG [GangsterEJB] Executing SQL: SELECT name, nick_name,
badness, organization
, hangout FROM GANGSTER WHERE (id=?)
22:44:31,658 DEBUG [GangsterEJB] Executing SQL: SELECT name, nick_name,
badness, organization
, hangout FROM GANGSTER WHERE (id=?)
22:44:31,670 INFO [ReadAheadTest]
###
#####
...

```

We will revisit this example and explore the output when we discuss the settings for optimized loading.

## 31.2. THE JBOSSCMP-JDBC STRUCTURE

The `jbosscmp-jdbc.xml` descriptor is used to control the behavior of the JBoss engine. This can be done globally through the `conf/standardjbosscmp-jdbc.xml` descriptor found in the server configuration file set, or per EJB JAR deployment via a `META-INF/jbosscmp-jdbc.xml` descriptor.

The DTD for the `jbosscmp-jdbc.xml` descriptor can be found in `<JBoss_HOME>/docs/dtd/jbosscmp-jdbc_4_0.dtd`. The public doctype for this DTD is:

```

<!DOCTYPE jbosscmp-jdbc PUBLIC
    "-//JBoss//DTD JBOSSCMP-JDBC 4.0//EN"
    "http://www.jboss.org/j2ee/dtd/jbosscmp-jdbc_4_0.dtd">

```

The top level elements are shown in [Figure 31.2, “The jbosscmp-jdbc content model.”](#)

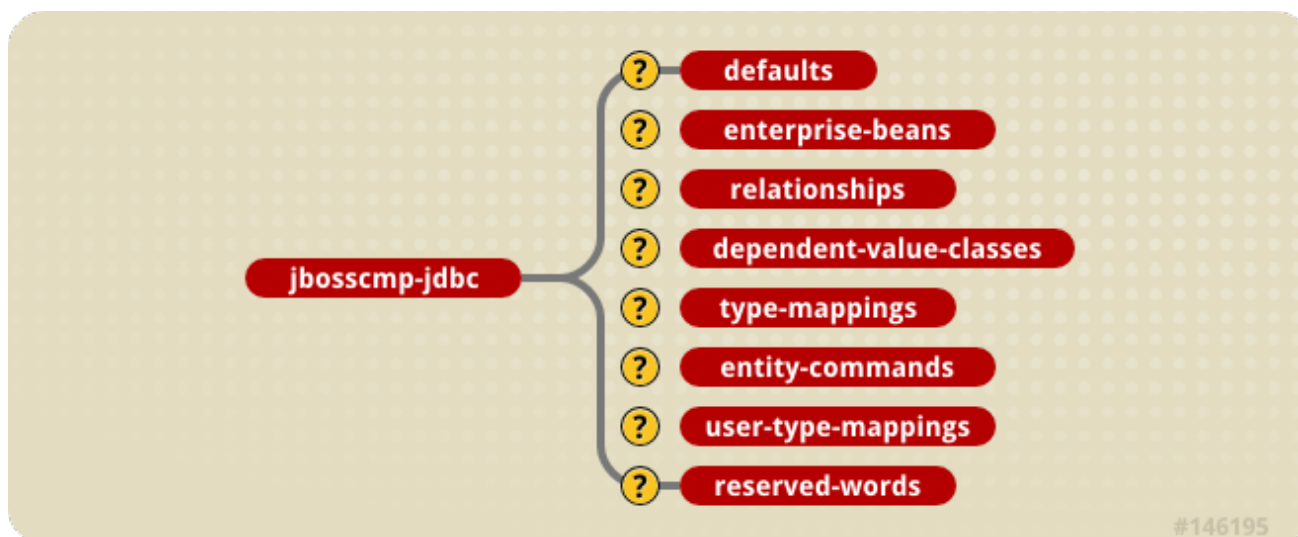

Figure 31.2. The jboss-cmp-jdbc content model.

- **defaults:** The defaults section allows for the specification of default behavior/settings for behavior that controls entity beans. Use of this section simplifies the amount of information needed for the common behaviors found in the entity beans section. See [Section 31.12, “Defaults”](#) for the details of the defaults content.
- **enterprise-beans:** The `enterprise-beans` element allows for customization of entity beans defined in the `ejb-jar.xml` `enterprise-beans` descriptor. This is described in detail in [Section 31.3, “Entity Beans”](#).
- **relationships:** The `relationships` element allows for the customization of tables and the loading behavior of entity relationships. This is described in detail in [Section 31.5, “Container Managed Relationships”](#).
- **dependent-value-classes:** The `dependent-value-classes` element allows for the customization of the mapping of dependent value classes to tables. Dependent value classes are described in detail in [Section 31.4.5, “Dependent Value Classes \(DVCs\)”](#) (DVCs).
- **type-mappings:** The `type-mappings` element defines the Java to SQL type mappings for a database, along with SQL templates, and function mappings. This is described in detail in [Section 31.13, “Datasource Customization”](#).
- **entity-commands:** The `entity-commands` element allows for the definition of the entity creation command instances that know how to create an entity instance in a persistent store. This is described in detail in [Section 31.11, “Entity Commands and Primary Key Generation”](#).
- **user-type-mappings:** The `user-type-mappings` elements defines a mapping of a user types to a column using a mapper class. A mapper is like a mediator. When storing, it takes an instance of the user type and translates it to a column value. When loading, it takes a column value and translates it to an instance of the user type. Details of the user type mappings are described in [Section 31.13.4, “User Type Mappings”](#).
- **reserved-words:** The `reserved-words` element defines one or more reserved words that should be escaped when generating tables. Each reserved word is specified as the content of a `word` element.

### 31.3. ENTITY BEANS

We will start our look at entity beans in JBoss by examining one of the CMP entity beans in the crime

portal. We will look at the gangster bean, which is implemented as local CMP entity bean. Although JBoss can provide remote entity beans with pass-by-reference semantics for calls in the same VM to get the performance benefit as from local entity beans, the use of local entity beans is strongly encouraged.

We will start with the required home interface. Since we are only concerned with the CMP fields at this point, we will show only the methods dealing with the CMP fields.

```
// Gangster Local Home Interface
public interface GangsterHome
    extends EJBLocalHome
{
    Gangster create(Integer id, String name, String nickName)
        throws CreateException;
    Gangster findByPrimaryKey(Integer id)
        throws FinderException;
}
```

The local interface is what clients will use to talk. Again, it contains only the CMP field accessors.

```
// Gangster Local Interface
public interface Gangster
    extends EJBLocalObject
{
    Integer getGangsterId();

    String getName();

    String getNickName();
    void setNickName(String nickName);

    int getBadness();
    void setBadness(int badness);
}
```

Finally, we have the actual gangster bean. Despite it's size, very little code is actually required. The bulk of the class is the create method.

```
// Gangster Implementation Class
public abstract class GangsterBean
    implements EntityBean
{
    private EntityContext ctx;
    private Category log = Category.getInstance(getClass());
    public Integer ejbCreate(Integer id, String name, String nickName)
        throws CreateException
    {
        log.info("Creating Gangster " + id + " '" + nickName + "' "+
name);
        setGangsterId(id);
        setName(name);
        setNickName(nickName);
        return null;
    }
}
```



```

public void ejbPostCreate(Integer id, String name, String nickName) {
}

// CMP field accessors -----
--
public abstract Integer getGangsterId();
public abstract void setGangsterId(Integer gangsterId);
public abstract String getName();
public abstract void setName(String name);
public abstract String getNickName();
public abstract void setNickName(String nickName);
public abstract int getBadness();
public abstract void setBadness(int badness);
public abstract ContactInfo getContactInfo();
public abstract void setContactInfo(ContactInfo contactInfo);
//...

// EJB callbacks -----
--
public void setEntityContext(EntityContext context) { ctx = context;
}
public void unsetEntityContext() { ctx = null; }
public void ejbActivate() { }
public void ejbPassivate() { }
public void ejbRemove() { log.info("Removing " + getName()); }
public void ejbStore() { }
public void ejbLoad() { }
}

```

The only thing missing now is the `ejb-jar.xml` deployment descriptor. Although the actual bean class is named `GangsterBean`, we've called the entity `GangsterEJB`.

```

<?xml version="1.0" encoding="UTF-8"?>
<ejb-jar xmlns="http://java.sun.com/xml/ns/"Whats_new_in_JBoss_4-
J2EE_Certification_and_Standards_Compliance" version="2.1"
  xmlns:xsi="http://www.w3.org/2001/XMLSchema-instance"
  xsi:schemaLocation="http://java.sun.com/xml/ns/j2ee
    http://java.sun.com/xml/ns/j2ee/ejb-
jar_2_1.xsd">
  <display-name>Crime Portal</display-name>

  <enterprise-beans>
    <entity>
      <display-name>Gangster Entity Bean</display-name>
      <ejb-name>GangsterEJB</ejb-name>
      <local-home>org.jboss.cmp2.crimeportal.GangsterHome</local-
home>
      <local>org.jboss.cmp2.crimeportal.Gangster</local>

      <ejb-class>org.jboss.cmp2.crimeportal.GangsterBean</ejb-class>
      <persistence-type>Container</persistence-type>
      <prim-key-class>java.lang.Integer</prim-key-class>
      <reentrant>False</reentrant>
      <cmp-version>2.x</cmp-version>
      <abstract-schema-name>gangster</abstract-schema-name>

```

```

        <cmp-field>
            <field-name>gangsterId</field-name>
        </cmp-field>
        <cmp-field>
            <field-name>name</field-name>
        </cmp-field>
        <cmp-field>
            <field-name>nickName</field-name>
        </cmp-field>
        <cmp-field>
            <field-name>badness</field-name>
        </cmp-field>
        <cmp-field>
            <field-name>contactInfo</field-name>
        </cmp-field>
        <primkey-field>gangsterId</primkey-field>

        <!-- ... -->
    </entity>
</enterprise-beans>
</ejb-jar>

```

Note that we've specified a CMP version of 2.x to indicate that this is EJB 2.x CMP entity bean. The abstract schema name was set to `gangster`. That will be important when we look at EJB-QL queries in [Section 31.6, "Queries"](#).

### 31.3.1. Entity Mapping

The JBoss configuration for the entity is declared with an `entity` element in the `jbosscmp-jdbc.xml` file. This file is located in the `META-INF` directory of the EJB JAR and contains all of the optional configuration information for configuring the CMP mapping. The `entity` elements for each entity bean are grouped together in the `enterprise-beans` element under the top level `jbosscmp-jdbc` element. A stubbed out entity configuration is shown below.

```

<?xml version="1.0" encoding="UTF-8"?>
<!DOCTYPE jbosscmp-jdbc PUBLIC
    "-//JBoss//DTD JBOSSCMP-JDBC 3.2//EN"
    "http://www.jboss.org/j2ee/dtd/jbosscmp-jdbc_3_2.dtd">
<jbosscmp-jdbc>
    <defaults>
        <!-- application-wide CMP defaults -->
    </defaults>
    <enterprise-beans>
        <entity>
            <ejb-name>GangsterEJB</ejb-name>
            <!-- overrides to defaults section -->
            <table-name>gangster</table-name>
            <!-- CMP Fields (see CMP-Fields) -->
            <!-- Load Groups (see Load Groups)-->
            <!-- Queries (see Queries) -->
        </entity>
    </enterprise-beans>
</jbosscmp-jdbc>

```

The `ejb-name` element is required to match the entity specification here with the one in the `ejb-`

`jar.xml` file. The remainder of the elements specify either overrides the global or application-wide CMP defaults and CMP mapping details specific to the bean. The application defaults come from the `defaults` section of the `jbosscmp-jdbc.xml` file and the global defaults come from the `defaults` section of the `standardjbosscmp-jdbc.xml` file in the `conf` directory for the current server configuration file set. The `defaults` section is discussed in [Section 31.12, “Defaults”](#). [Figure 31.3, “The entity element content model”](#) shows the full `entity` content model.



Figure 31.3. The entity element content model

A detailed description of each entity element follows:

- **ejb-name:** This required element is the name of the EJB to which this configuration applies. This element must match an `ejb-name` of an entity in the `ejb-jar.xml` file.
- **datasource:** This optional element is the `jndi-name` used to look up the datasource. All database connections used by an entity or relation-table are obtained from the datasource. Having different datasources for entities is not recommended, as it vastly constrains the domain over which finders and `ejbSelects` can query. The default is `java:/DefaultDS` unless overridden in the `defaults` section.

- **datasource-mapping:** This optional element specifies the name of the `type-mapping`, which determines how Java types are mapped to SQL types, and how EJB-QL functions are mapped to database specific functions. Type mappings are discussed in [Section 31.13.3, “Mapping”](#). The default is `Hypersonic SQL` unless overridden in the defaults section.
- **create-table:** This optional element when true, specifies that JBoss should attempt to create a table for the entity. When the application is deployed, JBoss checks if a table already exists before creating the table. If a table is found, it is logged, and the table is not created. This option is very useful during the early stages of development when the table structure changes often. The default is false unless overridden in the defaults section.
- **alter-table:** If `create-table` is used to automatically create the schema, `alter-table` can be used to keep the schema current with changes to the entity bean. Alter table will perform the following specific tasks:
  - new fields will be created
  - fields which are no longer used will be removed
  - string fields which are shorter than the declared length will have their length increased to the declared length. (not supported by all databases)
- **remove-table:** This optional element when true, JBoss will attempt to drop the table for each entity and each relation table mapped relationship. When the application is undeployed, JBoss will attempt to drop the table. This option is very useful during the early stages of development when the table structure changes often. The default is false unless overridden in the defaults section.
- **post-table-create:** This optional element specifies an arbitrary SQL statement that should be executed immediately after the database table is created. This command is only executed if `create-table` is true and the table did not previously exist.
- **read-only:** This optional element when true specifies that the bean provider will not be allowed to change the value of any fields. A field that is read-only will not be stored in, or inserted into, the database. If a primary key field is read-only, the create method will throw a `CreateException`. If a set accessor is called on a read-only field, it throws an `EJBException`. Read-only fields are useful for fields that are filled in by database triggers, such as last update. The `read-only` option can be overridden on a per `cmp-field` basis, and is discussed in [Section 31.4.3, “Read-only Fields”](#). The default is false unless overridden in the defaults section.
- **read-time-out:** This optional element is the amount of time in milliseconds that a read on a read-only field is valid. A value of 0 means that the value is always reloaded at the start of a transaction, and a value of -1 means that the value never times out. This option can also be overridden on a per `cmp-field` basis. If `read-only` is false, this value is ignored. The default is -1 unless overridden in the defaults section.
- **row-locking:** This optional element if true specifies that JBoss will lock all rows loaded in a transaction. Most databases implement this by using the `SELECT FOR UPDATE` syntax when loading the entity, but the actual syntax is determined by the `row-locking-template` in the datasource-mapping used by this entity. The default is false unless overridden in the defaults section.
- **pk-constraint:** This optional element if true specifies that JBoss will add a primary key constraint when creating tables. The default is true unless overridden in the defaults section.

- **read-ahead:** This optional element controls caching of query results and `cmr-fields` for the entity. This option is discussed in [Section 31.7.3, “Read-ahead”](#).
- **fetch-size:** This optional element specifies the number of entities to read in one round-trip to the underlying datastore. The default is 0 unless overridden in the defaults section.
- **list-cache-max:** This optional element specifies the number of read-lists that can be tracked by this entity. This option is discussed in [on-load](#). The default is 1000 unless overridden in the defaults section.
- **clean-read-ahead-on-load:** When an entity is loaded from the read ahead cache, JBoss can remove the data used from the read ahead cache. The default is `false`.
- **table-name:** This optional element is the name of the table that will hold data for this entity. Each entity instance will be stored in one row of this table. The default is the `ejb-name`.
- **cmp-field:** The optional element allows one to define how the `ejb-jar.xml` `cmp-field` is mapped onto the persistence store. This is discussed in [Section 31.4, “CMP Fields”](#).
- **load-groups:** This optional element specifies one or more groupings of CMP fields to declare load groupings of fields. This is discussed in [Section 31.7.2, “Load Groups”](#).
- **eager-load-groups:** This optional element defines one or more load grouping as eager load groups. This is discussed in [Section 31.8.2, “Eager-loading Process”](#).
- **lazy-load-groups:** This optional element defines one or more load grouping as lazy load groups. This is discussed in [Section 31.8.3, “Lazy loading Process”](#).
- **query:** This optional element specifies the definition of finders and selectors. This is discussed in [Section 31.6, “Queries”](#).
- **unknown-pk:** This optional element allows one to define how an unknown primary key type of `java.lang.Object` maps to the persistent store.
- **entity-command:** This optional element allows one to define the entity creation command instance. Typically this is used to define a custom command instance to allow for primary key generation. This is described in detail in [Section 31.11, “Entity Commands and Primary Key Generation”](#).
- **optimistic-locking:** This optional element defines the strategy to use for optimistic locking. This is described in detail in [Section 31.10, “Optimistic Locking”](#).
- **audit:** This optional element defines the CMP fields that will be audited. This is described in detail in [Section 31.4.4, “Auditing Entity Access”](#).

## 31.4. CMP FIELDS

CMP fields are declared on the bean class as abstract getter and setter methods that follow the JavaBean property accessor conventions. Our gangster bean, for example, has a `getName()` and a `setName()` method for accessing the `name` CMP field. In this section we will look at how to configure these declared CMP fields and control the persistence and behavior.

### 31.4.1. CMP Field Declaration

The declaration of a CMP field starts in the `ejb-jar.xml` file. On the gangster bean, for example, the `gangsterId`, `name`, `nickName` and `badness` would be declared in the `ejb-jar.xml` file as follows:

```

<ejb-jar>
  <enterprise-beans>
    <entity>
      <ejb-name>GangsterEJB</ejb-name>
      <cmp-field><field-name>gangsterId</field-name></cmp-field>
      <cmp-field><field-name>name</field-name></cmp-field>
      <cmp-field><field-name>nickName</field-name></cmp-field>
      <cmp-field><field-name>badness</field-name></cmp-field>
    </entity>
  </enterprise-beans>
</ejb-jar>

```

Note that the J2EE deployment descriptor does not declare any object-relational mapping details or other configuration. It is nothing more than a simple declaration of the CMP fields.

### 31.4.2. CMP Field Column Mapping

The relational mapping configuration of a CMP field is done in the `jbosscmp-jdbc.xml` file. The structure is similar to the `ejb-jar.xml` with an `entity` element that has `cmp-field` elements under it with the additional configuration details.

The following shows the basic column name and data type mappings for the gangster bean.

```

<jbosscmp-jdbc>
  <enterprise-beans>
    <entity>
      <ejb-name>GangsterEJB</ejb-name>
      <table-name>gangster</table-name>

      <cmp-field>
        <field-name>gangsterId</field-name>
        <column-name>id</column-name>
      </cmp-field>
      <cmp-field>
        <field-name>name</field-name>
        <column-name>name</column-name>
        <not-null/>
      </cmp-field>
      <cmp-field>
        <field-name>nickName</field-name>
        <column-name>nick_name</column-name>
        <jdbc-type>VARCHAR</jdbc-type>
        <sql-type>VARCHAR(64)</sql-type>
      </cmp-field>
      <cmp-field>
        <field-name>badness</field-name>
        <column-name>badness</column-name>
      </cmp-field>
    </entity>
  </enterprise-beans>
</jbosscmp-jdbc>

```

The full content model of the `cmp-field` element of the `jbosscmp-jdbc.xml` is shown below.

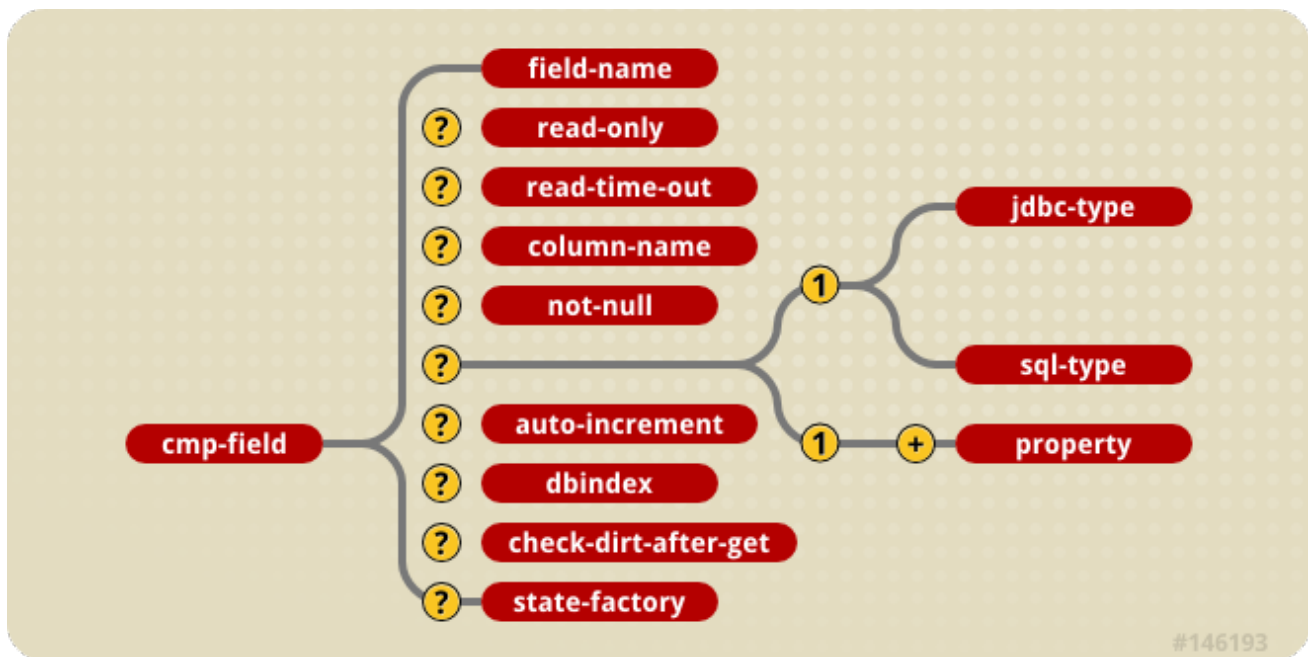

Figure 31.4. The JBoss entity element content model

A detailed description of each element follows:

- **field-name:** This required element is the name of the `cmp-field` that is being configured. It must match the `field-name` element of a `cmp-field` declared for this entity in the `ejb-jar.xml` file.
- **read-only:** This declares that field in question is read-only. This field will not be written to the database by JBoss. Read-only fields are discussed in [Section 31.4.3, “Read-only Fields”](#).
- **read-only-timeout:** This is the time in milliseconds that a read-only field value will be considered valid.
- **column-name:** This optional element is the name of the column to which the `cmp-field` is mapped. The default is to use the `field-name` value.
- **not-null:** This optional element indicates that JBoss should add a NOT NULL to the end of the column declaration when automatically creating the table for this entity. The default for primary key fields and primitives is not null.
- **jdbc-type:** This is the JDBC type that is used when setting parameters in a JDBC prepared statement or loading data from a JDBC result set. The valid types are defined in `java.sql.Types`. This is only required if `sql-type` is specified. The default JDBC type will be based on the database type in the `datasourcemappping`.
- **sql-type:** This is the SQL type that is used in create table statements for this field. Valid SQL types are only limited by your database vendor. This is only required if `jdbc-type` is specified. The default SQL type will be base on the database type in the `datasourcemappping`.
- **property:** This optional element allows one to define how the properties of a dependent value class CMP field should be mapped to the persistent store. This is discussed further in [Section 31.4.5, “Dependent Value Classes \(DVCs\)”](#).
- **auto-increment:** The presence of this optional field indicates that it is automatically incremented by the database layer. This is used to map a field to a generated column as well as to an externally manipulated column.

- **dbindex:** The presence of this optional field indicates that the server should create an index on the corresponding column in the database. The index name will be `fieldname_index`.
- **check-dirty-after-get:** This value defaults to false for primitive types and the basic `java.lang` immutable wrappers (`Integer`, `String`, etc...). For potentially mutable objects, JBoss will mark they field as potentially dirty after a get operation. If the dirty check on an object is too expensive, you can optimize it away by setting `check-dirty-after-get` to false.
- **state-factory:** This specifies class name of a state factory object which can perform dirty checking for this field. State factory classes must implement the `CMPCFieldStateFactory` interface.

### 31.4.3. Read-only Fields

JBoss allows for read-only CMP fields by setting the `read-only` and `read-time-out` elements in the `cmp-field` declaration. These elements work the same way as they do at the entity level. If a field is read-only, it will never be used in an `INSERT` or `UPDATE` statement. If a primary key field is `read-only`, the create method will throw a `CreateException`. If a set accessor is called for a read-only field, it throws an `EJBException`. Read-only fields are useful for fields that are filled in by database triggers, such as last update. A read-only CMP field declaration example follows:

```
<jbosscmp-jdbc>
  <enterprise-beans>
    <entity>
      <ejb-name>GangsterEJB</ejb-name>
      <cmp-field>
        <field-name>lastUpdated</field-name>
        <read-only>true</read-only>
        <read-time-out>1000</read-time-out>
      </cmp-field>
    </entity>
  </enterprise-beans>
</jbosscmp-jdbc>
```

### 31.4.4. Auditing Entity Access

The `audit` element of the entity section allows one to specify how access to and entity bean is audited. This is only allowed when an entity bean is accessed under a security domain so that this is a caller identity established. The content model of the audit element is given [Figure 31.5, “The jbosscmp-jdbc.xml audit element content model”](#).

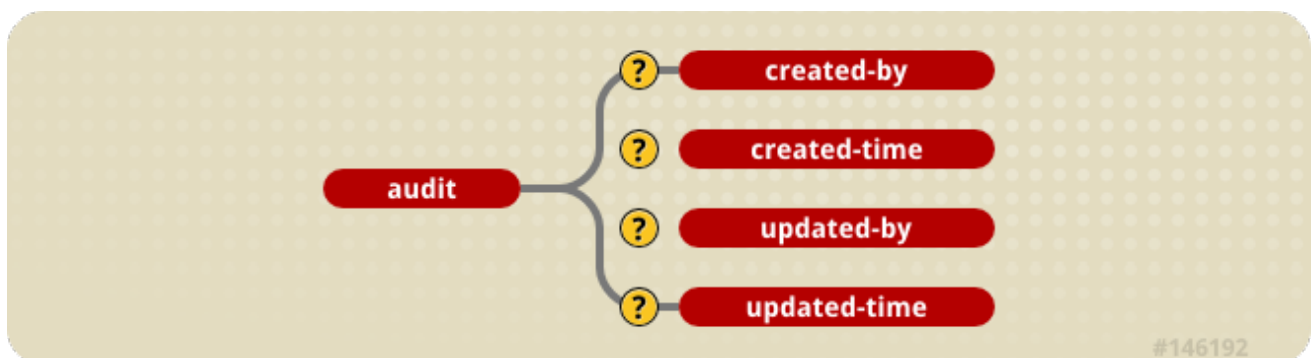

#146192

Figure 31.5. The `jbosscmp-jdbc.xml` audit element content model



- **created-by:** This optional element indicates that the caller who created the entity should be saved to either the indicated **column-name** or **cmp field-name**.
- **created-time:** This optional element indicates that the time of entity creation should be saved to either the indicated **column-name** or **cmp field-name**.
- **updated-by:** This optional element indicates that the caller who last modified the entity should be saved to either the indicated **column-name** or **CMP field-name**.
- **updated-time:** This optional element indicates that the last time of entity modification should be saved to either the indicated **column-name** or **CMP field-name**.

For each element, if a **field-name** is given, the corresponding audit information should be stored in the specified CMP field of the entity bean being accessed. Note that there does not have to be an corresponding CMP field declared on the entity. In case there are matching field names, you will be able to access audit fields in the application using the corresponding CMP field abstract getters and setters. Otherwise, the audit fields will be created and added to the entity internally. You will be able to access audit information in EJB-QL queries using the audit field names, but not directly through the entity accessors.

If, on the other hand, a **column-name** is specified, the corresponding audit information should be stored in the indicated column of the entity table. If JBoss is creating the table the **jdbc-type** and **sql-type** element can then be used to define the storage type.

The declaration of audit information with given column names is shown below.

```
<jbosscmp-jdbc>
  <enterprise-beans>
    <entity>
      <ejb-name>AuditChangedNamesEJB</ejb-name>
      <table-name>cmp2_audit_changednames</table-name>
      <audit>
        <created-by>
          <column-name>createdby</column-name>
        </created-by>
        <created-time>
          <column-name>createdtime</column-name>
        </created-time>
        <updated-by>
          <column-name>updatedby</column-name></updated-by>
        <updated-time>
          <column-name>updatedtime</column-name>
        </updated-time>
      </audit>
    </entity>
  </enterprise-beans>
</jbosscmp-jdbc>
```

### 31.4.5. Dependent Value Classes (DVCs)

A dependent value class (DVC) is a fancy term used to identify any Java class that is the type of a **cmp-field** other than the automatically recognized types core types such as strings and number values. By default, a DVC is serialized, and the serialized form is stored in a single database column. Although not discussed here, there are several known issues with the long-term storage of classes in serialized form.

JBoss also supports the storage of the internal data of a DVC into one or more columns. This is useful for supporting legacy JavaBeans and database structures. It is not uncommon to find a database with a highly flattened structure (e.g., a `PURCHASE_ORDER` table with the fields `SHIP_LINE1`, `SHIP_LINE2`, `SHIP_CITY`, etc. and an additional set of fields for the billing address). Other common database structures include telephone numbers with separate fields for area code, exchange, and extension, or a person's name spread across several fields. With a DVC, multiple columns can be mapped to one logical field.

JBoss requires that a DVC to be mapped must follow the JavaBeans naming specification for simple properties, and that each property to be stored in the database must have both a getter and a setter method. Furthermore, the bean must be serializable and must have a no argument constructor. A property can be any simple type, an un-mapped DVC or a mapped DVC, but cannot be an EJB. A DVC mapping is specified in a `dependent-value-class` element within the `dependent-value-classes` element.

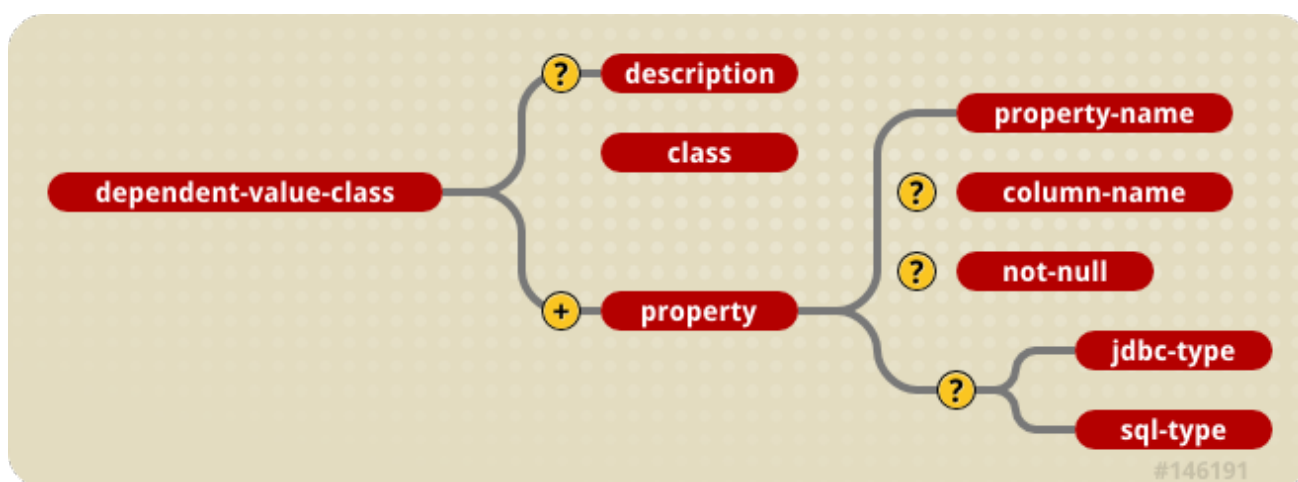

Figure 31.6. The `jbosscmp-jdbc` `dependent-value-class` element model.

Here is an example of a simple `ContactInfo` DVC class.

```

public class ContactInfo
    implements Serializable
{
    /** The cell phone number. */
    private PhoneNumber cell;

    /** The pager number. */
    private PhoneNumber pager;

    /** The email address */
    private String email;

    /**
     * Creates empty contact info.
     */
    public ContactInfo() {
    }

    public PhoneNumber getCell() {
        return cell;
    }
}

```

```

public void setCell(PhoneNumber cell) {
    this.cell = cell;
}

public PhoneNumber getPager() {
    return pager;
}

public void setPager(PhoneNumber pager) {
    this.pager = pager;
}

public String getEmail() {
    return email;
}

public void setEmail(String email) {
    this.email = email.toLowerCase();
}

// ... equals, hashCode, toString
}

```

The contact info includes a phone number, which is represented by another DVC class.

```

public class PhoneNumber
    implements Serializable
{
    /** The first three digits of the phone number. */
    private short areaCode;

    /** The middle three digits of the phone number. */
    private short exchange;

    /** The last four digits of the phone number. */
    private short extension;

    // ... getters and setters

    // ... equals, hashCode, toString
}

```

The DVC mappings for these two classes are relatively straight forward.

```

<dependent-value-classes>
  <dependent-value-class>
    <description>A phone number</description>
    <class>org.jboss.cmp2.crimeportal.PhoneNumber</class>
    <property>
      <property-name>areaCode</property-name>
      <column-name>area_code</column-name>
    </property>
    <property>
      <property-name>exchange</property-name>
      <column-name>exchange</column-name>
    </property>
  </dependent-value-class>
</dependent-value-classes>

```

```

    <property>
      <property-name>extension</property-name>
      <column-name>extension</column-name>
    </property>
  </dependent-value-class>

  <dependent-value-class>
    <description>General contact info</description>
    <class>org.jboss.cmp2.crimeportal.ContactInfo</class>
    <property>
      <property-name>cell</property-name>
      <column-name>cell</column-name>
    </property>
    <property>
      <property-name>pager</property-name>
      <column-name>pager</column-name>
    </property>
    <property>
      <property-name>email</property-name>
      <column-name>email</column-name>
      <jdbc-type>VARCHAR</jdbc-type>
      <sql-type>VARCHAR(128)</sql-type>
    </property>
  </dependent-value-class>
</dependent-value-classes>

```

Each DVC is declared with a **dependent-value-class** element. A DVC is identified by the Java class type declared in the class element. Each property to be persisted is declared with a property element. This specification is based on the **cmp-field** element, so it should be self-explanatory. This restriction will also be removed in a future release. The current proposal involves storing the primary key fields in the case of a local entity and the entity handle in the case of a remote entity.

The **dependent-value-classes** section defines the internal structure and default mapping of the classes. When JBoss encounters a field that has an unknown type, it searches the list of registered DVCs, and if a DVC is found, it persists this field into a set of columns, otherwise the field is stored in serialized form in a single column. JBoss does not support inheritance of DVCs; therefore, this search is only based on the declared type of the field. A DVC can be constructed from other DVCs, so when JBoss runs into a DVC, it flattens the DVC tree structure into a set of columns. If JBoss finds a DVC circuit during start up, it will throw an **EJBException**. The default column name of a property is the column name of the base **cmp-field** followed by an underscore and then the column name of the property. If the property is a DVC, the process is repeated. For example, a **cmp-field** named **info** that uses the **ContactInfo** DVC would have the following columns:

```

info_cell_area_code
info_cell_exchange
info_cell_extension
info_pager_area_code
info_pager_exchange
info_pager_extension
info_email

```

The automatically generated column names can quickly become excessively long and awkward. The default mappings of columns can be overridden in the entity element as follows:

```

<jbosscmp-jdbc>

```

```

<enterprise-beans>
  <entity>
    <ejb-name>GangsterEJB</ejb-name>
    <cmp-field>
      <field-name>contactInfo</field-name>
      <property>
        <property-name>cell.areaCode</property-name>
        <column-name>cell_area</column-name>
      </property>
      <property>
        <property-name>cell.exchange</property-name>
        <column-name>cell_exch</column-name>
      </property>
      <property>
        <property-name>cell.extension</property-name>
        <column-name>cell_ext</column-name>
      </property>

      <property>
        <property-name>pager.areaCode</property-name>
        <column-name>page_area</column-name>
      </property>
      <property>
        <property-name>pager.exchange</property-name>
        <column-name>page_exch</column-name>
      </property>
      <property>
        <property-name>pager.extension</property-name>
        <column-name>page_ext</column-name>
      </property>

      <property>
        <property-name>email</property-name>
        <column-name>email</column-name>
        <jdbc-type>VARCHAR</jdbc-type>
        <sql-type>VARCHAR(128)</sql-type>
      </property>
    </cmp-field>
  </entity>
</enterprise-beans>
</jbosscmp-jdbc>

```

When overriding property info for the entity, you need to refer to the property from a flat perspective as in `cell.areaCode`.

## 31.5. CONTAINER MANAGED RELATIONSHIPS

Container Managed Relationships (CMRs) are a powerful new feature of CMP 2.0. Programmers have been creating relationships between entity objects since EJB 1.0 was introduced (not to mention since the introduction of databases), but before CMP 2.0 the programmer had to write a lot of code for each relationship in order to extract the primary key of the related entity and store it in a pseudo foreign key field. The simplest relationships were tedious to code, and complex relationships with referential integrity required many hours to code. With CMP 2.0 there is no need to code relationships by hand. The container can manage one-to-one, one-to-many and many-to-many relationships, with referential

integrity. One restriction with CMRs is that they are only defined between local interfaces. This means that a relationship cannot be created between two entities in separate applications, even in the same application server.

There are two basic steps to create a container managed relationship: create the `cmr-field` abstract accessors and declare the relationship in the `ejb-jar.xml` file. The following two sections describe these steps.

### 31.5.1. CMR-Field Abstract Accessors

CMR-Field abstract accessors have the same signatures as `cmp-fields`, except that single-valued relationships must return the local interface of the related entity, and multi-valued relationships can only return a `java.util.Collection` (or `java.util.Set`) object. For example, to declare a one-to-many relationship between `organization` and `gangster`, we declare the relationship from `organization` to `gangster` in the `OrganizationBean` class:

```
public abstract class OrganizationBean
    implements EntityBean
{
    public abstract Set getMemberGangsters();
    public abstract void setMemberGangsters(Set gangsters);
}
```

We also can declare the relationship from `gangster` to `organization` in the `GangsterBean` class:

```
public abstract class GangsterBean
    implements EntityBean
{
    public abstract Organization getOrganization();
    public abstract void setOrganization(Organization org);
}
```

Although each bean declared a CMR field, only one of the two beans in a relationship must have a set of accessors. As with CMP fields, a CMR field is required to have both a getter and a setter method.

### 31.5.2. Relationship Declaration

The declaration of relationships in the `ejb-jar.xml` file is complicated and error prone. Although we recommend using a tool like XDoclet to manage the deployment descriptors for CMR fields, it's still important to understand how the descriptor works. The following illustrates the declaration of the `organization/gangster` relationship:

```
<ejb-jar>
  <relationships>
    <ejb-relation>
      <ejb-relation-name>Organization-Gangster</ejb-relation-name>
      <ejb-relationship-role>
        <ejb-relationship-role-name>org-has-gangsters </ejb-
relationship-role-name>
        <multiplicity>One</multiplicity>
        <relationship-role-source>
          <ejb-name>OrganizationEJB</ejb-name>
        </relationship-role-source>
      <cmr-field>
```

```

        <cmr-field-name>memberGangsters</cmr-field-name>
        <cmr-field-type>java.util.Set</cmr-field-type>
    </cmr-field>
</ejb-relationship-role>
<ejb-relationship-role>
    <ejb-relationship-role-name>
        gangster-belongs-to-org
    </ejb-relationship-role-name>
    <multiplicity>Many</multiplicity>
    <cascade-delete/>
    <relationship-role-source>
        <ejb-name>GangsterEJB</ejb-name>
    </relationship-role-source>
    <cmr-field>
        <cmr-field-name>organization</cmr-field-name>
    </cmr-field>
</ejb-relationship-role>
</ejb-relation>
</relationships>
</ejb-jar>

```

As you can see, each relationship is declared with an `ejb-relation` element within the top level `relationships` element. The relation is given a name in the `ejb-relation-name` element. This is important because we will need to refer to the role by name in the `jbosscmp-jdbc.xml` file. Each `ejb-relation` contains two `ejb-relationship-role` elements (one for each side of the relationship). The `ejb-relationship-role` tags are as follows:

- **ejb-relationshiprole-name:** This optional element is used to identify the role and match the database mapping the `jbosscmp-jdbc.xml` file. The relationship role names for each side of a relationship must be different.
- **multiplicity:** This indicates the multiplicity of this side of the relationship. The valid values are **One** or **Many**. In this example, the multiplicity of the organization is **One** and the multiplicity of the gangster is **Many** because the relationship is from one organization to many gangsters. Note, as with all XML elements, this element is case sensitive.
- **cascade-delete:** When this optional element is present, JBoss will delete the child entity when the parent entity is deleted. Cascade deletion is only allowed for a role where the other side of the relationship has a multiplicity of one. The default is to not cascade delete.
- **relationship-role-source**
  - **ejb-name:** This required element gives the name of the entity that has the role.
- **cmr-field**
  - **cmr-field-name:** This is the name of the CMR field of the entity has one, if it has one.
  - **cmr-field-type:** This is the type of the CMR field, if the field is a collection type. It must be `java.util.Collection` or `java.util.Set`.

After adding the CMR field abstract accessors and declaring the relationship, the relationship should be functional. The next section discusses the database mapping of the relationship.

### 31.5.3. Relationship Mapping

Relationships can be mapped using either a foreign key or a separate relation table. One-to-one and one-to-many relationships use the foreign key mapping style by default, and many-to-many relationships use only the relation table mapping style. The mapping of a relationship is declared in the `relationships` section of the `jbosscmp-jdbc.xml` descriptor via `ejb-relation` elements. Relationships are identified by the `ejb-relation-name` from the `ejb-jar.xml` file. The `jbosscmp-jdbc.xml` `ejb-relation` element content model is shown in [Figure 31.7, “The jbosscmp-jdbc.xml ejb-relation element content model”](#).

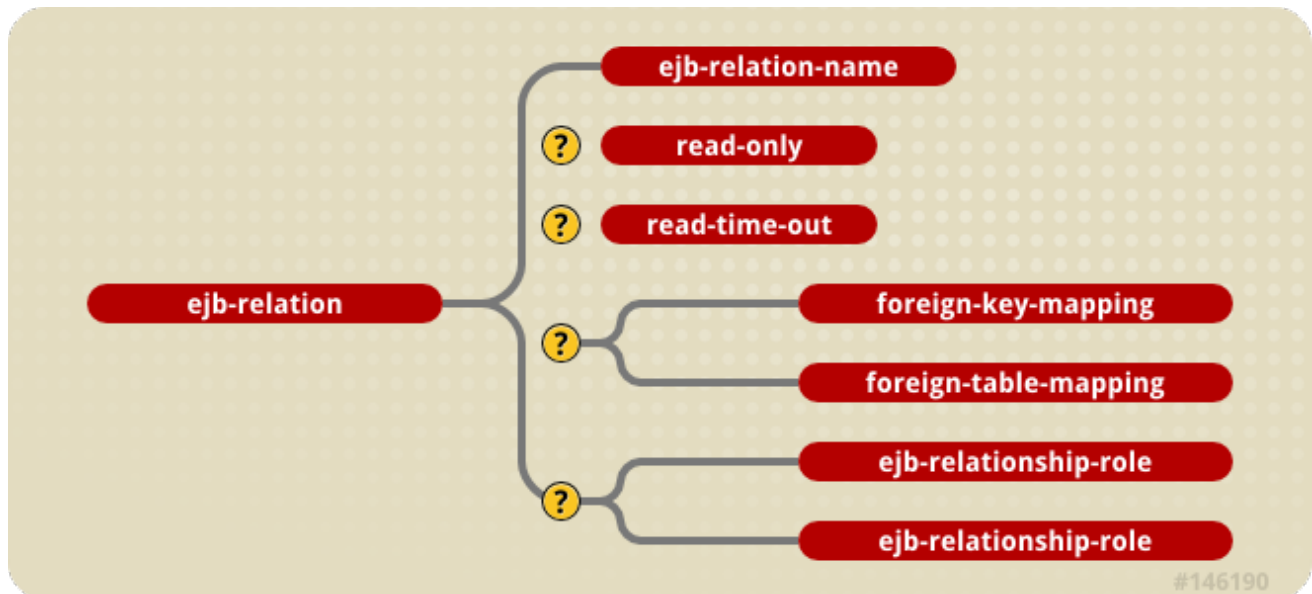

**Figure 31.7. The jbosscmp-jdbc.xml ejb-relation element content model**

The basic template of the relationship mapping declaration for `Organization-Gangster` relationship follows:

```
<jbosscmp-jdbc>
  <relationships>
    <ejb-relation>
      <ejb-relation-name>Organization-Gangster</ejb-relation-name>
      <foreign-key-mapping/>
      <ejb-relationship-role>
        <ejb-relationship-role-name>org-has-gangsters</ejb-
relationship-role-name>
        <key-fields>
          <key-field>
            <field-name>name</field-name>
            <column-name>organization</column-name>
          </key-field>
        </key-fields>
      </ejb-relationship-role>
      <ejb-relationship-role>
        <ejb-relationship-role-name>gangster-belongs-to-org</ejb-
relationship-role-name>
        <key-fields/>
      </ejb-relationship-role>
    </ejb-relation>
  </relationships>
</jbosscmp-jdbc>
```



After the `ejb-relation-name` of the relationship being mapped is declared, the relationship can be declared as read only using the `read-only` and `read-time-out` elements. They have the same semantics as their counterparts in the entity element.

The `ejb-relation` element must contain either a `foreign-key-mapping` element or a `relation-table-mapping` element, which are described in [Section 31.5.3.2, “Foreign Key Mapping”](#) and [Section 31.5.3.3, “Relation table Mapping”](#). This element may also contain a pair of `ejb-relationship-role` elements as described in the following section.

### 31.5.3.1. Relationship Role Mapping

Each of the two `ejb-relationship-role` elements contains mapping information specific to an entity in the relationship. The content model of the `ejb-relationship-role` element is shown in [Figure 31.8, “The jbossCMP-jdbc ejb-relationship-role element content model”](#).

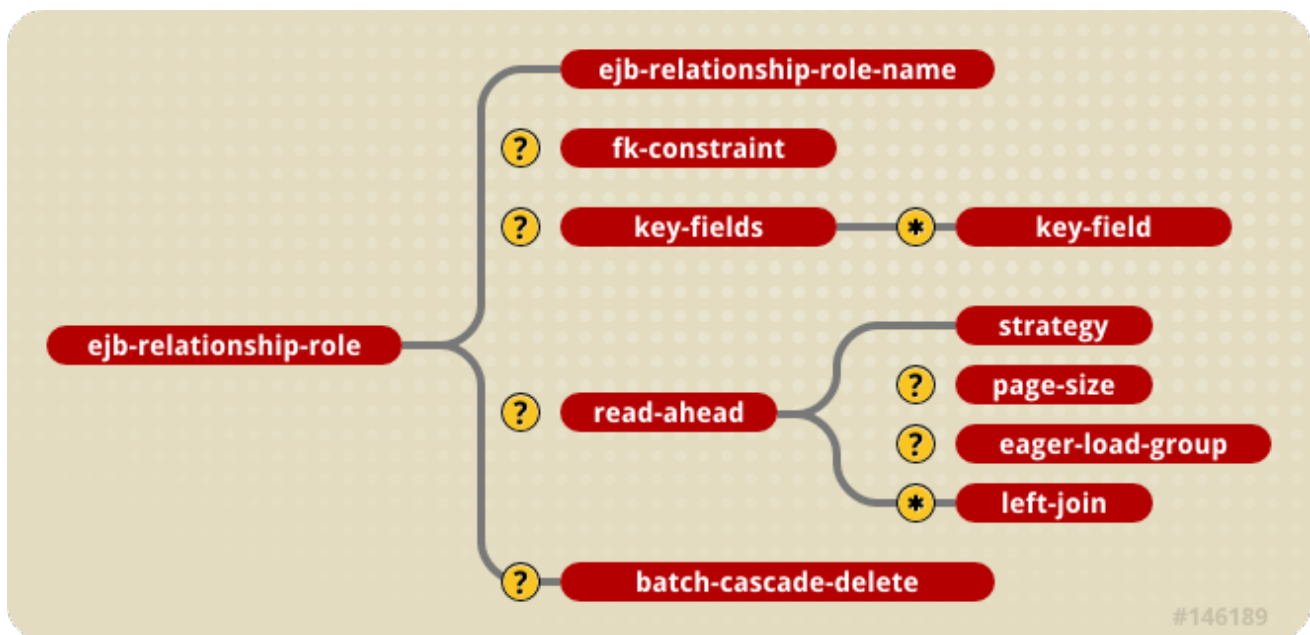

Figure 31.8. The jbossCMP-jdbc `ejb-relationship-role` element content model

A detailed description of the main elements follows:

- **ejb-relationship-role-name:** This required element gives the name of the role to which this configuration applies. It must match the name of one of the roles declared for this relationship in the `ejb-jar.xml` file.
- **fk-constraint:** This optional element is a true/false value that indicates whether JBoss should add a foreign key constraint to the tables for this side of the relationship. JBoss will only add generate the constraint if both the primary table and the related table were created by JBoss during deployment.
- **key-fields:** This optional element specifies the mapping of the primary key fields of the current entity, whether it is mapped in the relation table or in the related object. The `key-fields` element must contain a `key-field` element for each primary key field of the current entity. The `key-fields` element can be empty if no foreign key mapping is needed for this side of the relation. An example of this would be the many side of a one-to-many relationship. The details of this element are described below.
- **read-ahead:** This optional element controls the caching of this relationship. This option is discussed in [Section 31.8.3.1, “Relationships”](#).

- **batch-cascade-delete:** This indicates that a cascade delete on this relationship should be performed with a single SQL statement. This requires that the relationship be marked as **batch-delete** in the **ejb-jar.xml**.

As noted above, the **key-fields** element contains a **key-field** for each primary key field of the current entity. The **key-field** element uses the same syntax as the **cmp-field** element of the entity, except that **key-field** does not support the **not-null** option. Key fields of a **relation-table** are automatically not null, because they are the primary key of the table. On the other hand, foreign key fields must be nullable by default. This is because the CMP specification requires an insert into the database after the **ejbCreate** method and an update to it after to pick up CMR changes made in **ejbPostCreate**. Since the EJB specification does not allow a relationship to be modified until **ejbPostCreate**, a foreign key will be initially set to null. There is a similar problem with removal. You can change this insert behavior using the **jboss.xmlinsert-after-ejb-post-create** container configuration flag. The following example illustrates the creation of a new bean configuration that uses **insert-after-ejb-post-create** by default.

```
<jboss>
  <!-- ... -->
  <container-configurations>
    <container-configuration extends="Standard CMP 2.x EntityBean">
      <container-name>INSERT after ejbPostCreate
Container</container-name>
      <insert-after-ejb-post-create>true</insert-after-ejb-post-
create>
    </container-configuration>
  </container-configurations>
</jboss>
```

An alternate means of working around the non-null foreign key issue is to map the foreign key elements onto non-null CMP fields. In this case you simply populate the foreign key fields in **ejbCreate** using the associated CMP field setters.

The content model of the **key-fields** element is [Figure 31.9, “The jbosscmp-jdbc key-fields element content model”](#).

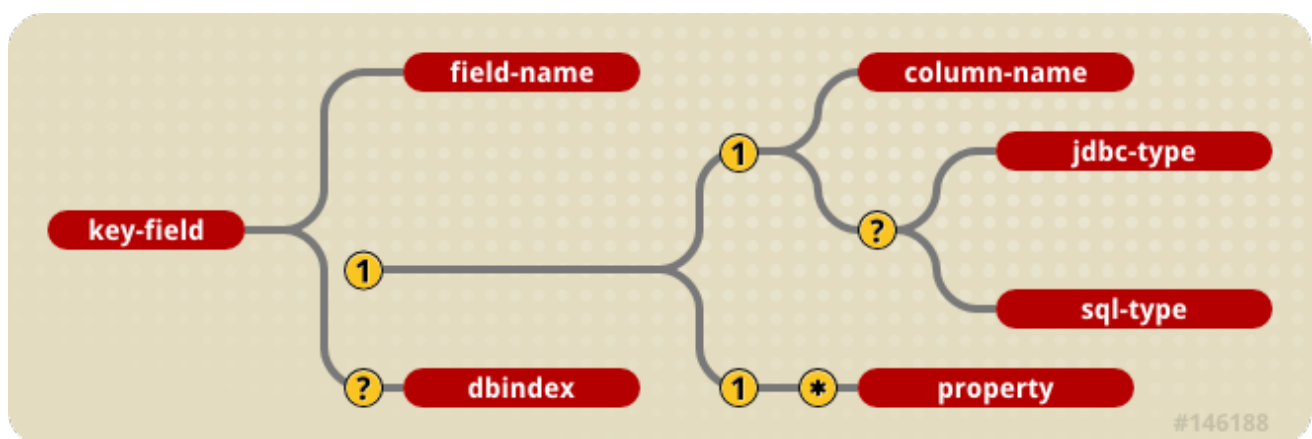

**Figure 31.9.** The **jbosscmp-jdbc** **key-fields** element content model

A detailed description of the elements contained in the **key-field** element follows:

- **field-name:** This required element identifies the field to which this mapping applies. This name must match a primary key field of the current entity.

- **column-name:** Use this element to specify the column name in which this primary key field will be stored. If this is relationship uses **foreign-key-mapping**, this column will be added to the table for the related entity. If this relationship uses **relation-table-mapping**, this column is added to the **relation-table**. This element is not allowed for mapped dependent value class; instead use the property element.
- **jdbc-type:** This is the JDBC type that is used when setting parameters in a JDBC **PreparedStatement** or loading data from a JDBC **ResultSet**. The valid types are defined in `java.sql.Types`.
- **sql-type:** This is the SQL type that is used in create table statements for this field. Valid types are only limited by your database vendor.
- **property:** Use this element for to specify the mapping of a primary key field which is a dependent value class.
- **dbindex:** The presence of this optional field indicates that the server should create an index on the corresponding column in the database, and the index name will be `fieldname_index`.

### 31.5.3.2. Foreign Key Mapping

Foreign key mapping is the most common mapping style for one-to-one and one-to-many relationships, but is not allowed for many-to many relationships. The foreign key mapping element is simply declared by adding an empty **foreign-key-mapping** element to the **ejb-relation** element.

As noted in the previous section, with a foreign key mapping the **key-fields** declared in the **ejb-relationship-role** are added to the table of the related entity. If the **key-fields** element is empty, a foreign key will not be created for the entity. In a one-to-many relationship, the many side (**Gangster** in the example) must have an empty **key-fields** element, and the one side (**Organization** in the example) must have a **key-fields** mapping. In one-to-one relationships, one or both roles can have foreign keys.

The foreign key mapping is not dependent on the direction of the relationship. This means that in a one-to-one unidirectional relationship (only one side has an accessor) one or both roles can still have foreign keys. The complete foreign key mapping for the **Organization-Gangster** relationship is shown below with the foreign key elements:

```
<jbosscmp-jdbc>
  <relationships>
    <ejb-relation>
      <ejb-relation-name>Organization-Gangster</ejb-relation-name>
      <foreign-key-mapping/>
      <ejb-relationship-role>
        <ejb-relationship-role-name>org-has-gangsters</ejb-
relationship-role-name>
        <key-fields> <key-field> <field-name>name</field-name>
<column-name>organization</column-name> </key-field> </key-fields>
      </ejb-relationship-role>
      <ejb-relationship-role>
        <ejb-relationship-role-name>gangster-belongs-to-org</ejb-
relationship-role-name>
        <key-fields/>
      </ejb-relationship-role>
```

```

    </ejb-relation>
  </relationships>
</jbosscomp-jdbc>

```

### 31.5.3.3. Relation table Mapping

Relation table mapping is less common for one-to-one and one-to-many relationships, but is the only mapping style allowed for many-to-many relationships. Relation table mapping is defined using the `relation-table-mapping` element, the content model of which is shown below.

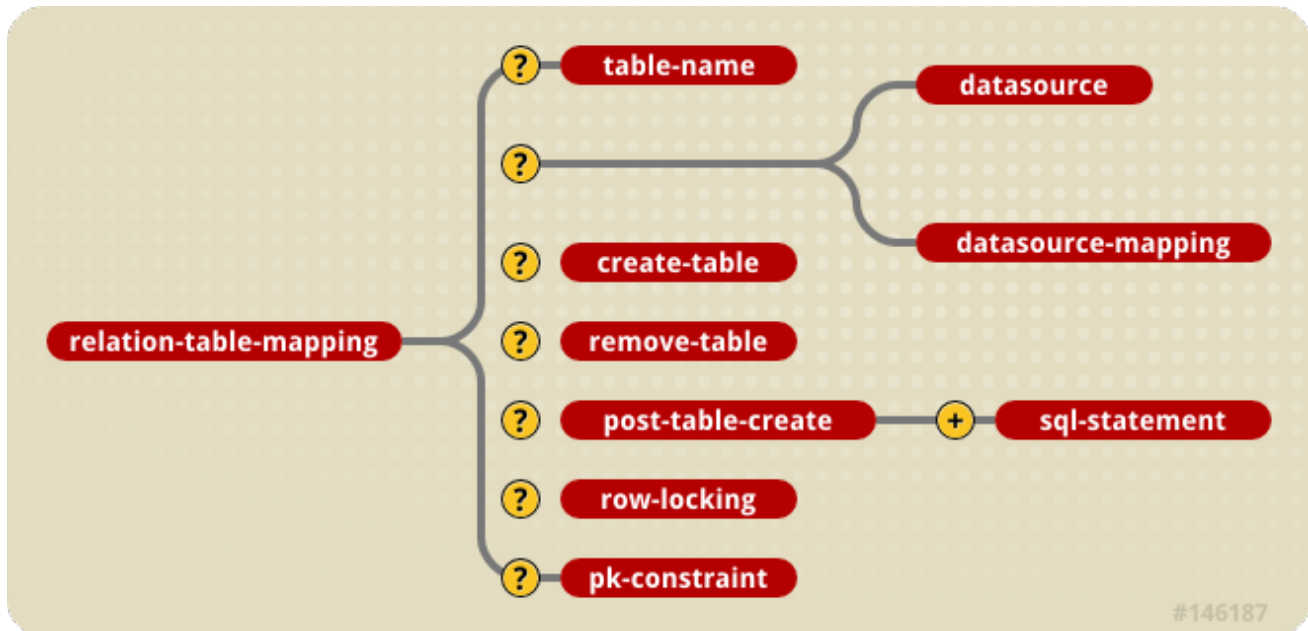

Figure 31.10. The `jbosscomp-jdbc` `relation-table-mapping` element content model

The `relation-table-mapping` for the `Gangster - Job` relationship is shown in with table mapping elements:

#### Example 31.1. The `jbosscomp-jdbc.xml` Relation-table Mapping

```

<jbosscomp-jdbc>
  <relationships>
    <ejb-relation>
      <ejb-relation-name>Gangster-Jobs</ejb-relation-name>
      <relation-table-mapping>
        <table-name>gangster_job</table-name>
      </relation-table-mapping>
      <ejb-relationship-role>
        <ejb-relationship-role-name>gangster-has-jobs</ejb-
relationship-role-name>
        <key-fields>
          <key-field>
            <field-name>gangsterId</field-name>
            <column-name>gangster</column-name>
          </key-field>
        </key-fields>
      </ejb-relationship-role>
      <ejb-relationship-role>
        <ejb-relationship-role-name>job-has-gangsters</ejb-
relationship-role-name>

```

```

        <key-fields>
            <key-field>
                <field-name>name</field-name>
                <column-name>job</column-name>
            </key-field>
        </key-fields>
    </ejb-relationship-role>
</ejb-relation>
</relationships>
</jboss-cmp-jdbc>

```

The `relation-table-mapping` element contains a subset of the options available in the `entity` element. A detailed description of these elements is reproduced here for convenience:

- **table-name:** This optional element gives the name of the table that will hold data for this relationship. The default table name is based on the entity and `cmr-field` names.
- **datasource:** This optional element gives the `jndi-name` used to look up the datasource. All database connections are obtained from the datasource. Having different datasources for entities is not recommended, as it vastly constrains the domain over which finders and `ejbSelects` can query.
- **datasourcemapping:** This optional element allows one to specify the name of the `type-mapping` to use.
- **create-table:** This optional element if true indicates JBoss should attempt to create a table for the relationship. When the application is deployed, JBoss checks if a table already exists before creating the table. If a table is found, it is logged, and the table is not created. This option is very useful during the early stages of development when the table structure changes often.
- **post-table-create:** This optional element specifies an arbitrary SQL statement that should be executed immediately after the database table is created. This command is only executed if `create-table` is true and the table did not previously exist.
- **remove-table:** This optional element if true indicates JBoss should attempt to drop the `relation-table` when the application is undeployed. This option is very useful during the early stages of development when the table structure changes often.
- **row-locking:** This optional element if true indicates JBoss should lock all rows loaded in a transaction. Most databases implement this by using the `SELECT FOR UPDATE` syntax when loading the entity, but the actual syntax is determined by the `row-locking-template` in the `datasource-mapping` used by this entity.
- **pk-constraint:** This optional element if true indicates JBoss should add a primary key constraint when creating tables.

## 31.6. QUERIES

Entity beans allow for two types of queries: finders and selects. A finder provides queries on an entity bean to clients of the bean. The select method is designed to provide private query statements to an entity implementation. Unlike finders, which are restricted to only return entities of the same type as

the home interface on which they are defined, select methods can return any entity type or just one field of the entity. EJB-QL is the query language used to specify finders and select methods in a platform independent way.

### 31.6.1. Finder and select Declaration

The declaration of finders has not changed in CMP 2.0. Finders are still declared in the home interface (local or remote) of the entity. Finders defined on the local home interface do not throw a `RemoteException`. The following code declares the `findBadDudes_ejbql` finder on the `GangsterHome` interface. The `ejbql` suffix here is not required. It is simply a naming convention used here to differentiate the different types of query specifications we will be looking at.

```
public interface GangsterHome
    extends EJBLocalHome
{
    Collection findBadDudes_ejbql(int badness) throws FinderException;
}
```

Select methods are declared in the entity implementation class, and must be public and abstract just like CMP and CMR field abstract accessors and must throw a `FinderException`. The following code declares an select method:

```
public abstract class GangsterBean
    implements EntityBean
{
    public abstract Set ejbSelectBoss_ejbql(String name)
        throws FinderException;
}
```

### 31.6.2. EJB-QL Declaration

Every select or finder method (except `findByPrimaryKey`) must have an EJB-QL query defined in the `ejb-jar.xml` file. The EJB-QL query is declared in a query element, which is contained in the entity element. The following are the declarations for `findBadDudes_ejbql` and `ejbSelectBoss_ejbql` queries:

```
<ejb-jar>
  <enterprise-beans>
    <entity>
      <ejb-name>GangsterEJB</ejb-name>
      <!-- ... -->
      <query>
        <query-method>
          <method-name>findBadDudes_ejbql</method-name>
          <method-params>
            <method-param>int</method-param>
          </method-params>
        </query-method>
        <ejb-ql>
          SELECT OBJECT(g) FROM gangster g WHERE g.badness > ?1
        </ejb-ql>
      </query>
      <query>
        <query-method>
```

```

        <method-name>ejbSelectBoss_ejbql</method-name>
        <method-params>
            <method-param>java.lang.String</method-param>
        </method-params>
    </query-method>
    <ejb-ql>
        SELECT DISTINCT underling.organization.theBoss FROM
gangster underling WHERE underling.name = ?1 OR underling.nickName = ?1
    </ejb-ql>
</query>
</entity>
</enterprise-beans>
</ejb-jar>

```

EJB-QL is similar to SQL but has some surprising differences. The following are some important things to note about EJB-QL:

- EJB-QL is a typed language, meaning that it only allows comparison of like types (i.e., strings can only be compared with strings).
- In an equals comparison a variable (single valued path) must be on the left hand side. Some examples follow:

```

g.hangout.state = 'CA' Legal
'CA' = g.shippingAddress.state NOT Legal
'CA' = 'CA' NOT Legal
(r.amountPaid * .01) > 300 NOT Legal
r.amountPaid > (300 / .01) Legal

```

- Parameters use a base 1 index like `java.sql.PreparedStatement`.
- Parameters are only allowed on the right hand side of a comparison. For example:

```

gangster.hangout.state = ?1 Legal
?1 = gangster.hangout.state NOT Legal

```

### 31.6.3. Overriding the EJB-QL to SQL Mapping

The EJB-QL query can be overridden in the `jbosscmp-jdbc.xml` file. The finder or select is still required to have an EJB-QL declaration, but the `ejb-ql` element can be left empty. Currently the SQL can be overridden with JBossQL, DynamicQL, DeclaredSQL or a BMP style custom `ejbFind` method. All EJB-QL overrides are non-standard extensions to the EJB specification, so use of these extensions will limit portability of your application. All of the EJB-QL overrides, except for BMP custom finders, are declared using a `query` element in the `jbosscmp-jdbc.xml` file. The content model is shown in [Figure 31.11, “The jbosscmp-jdbc query element content model”](#) .

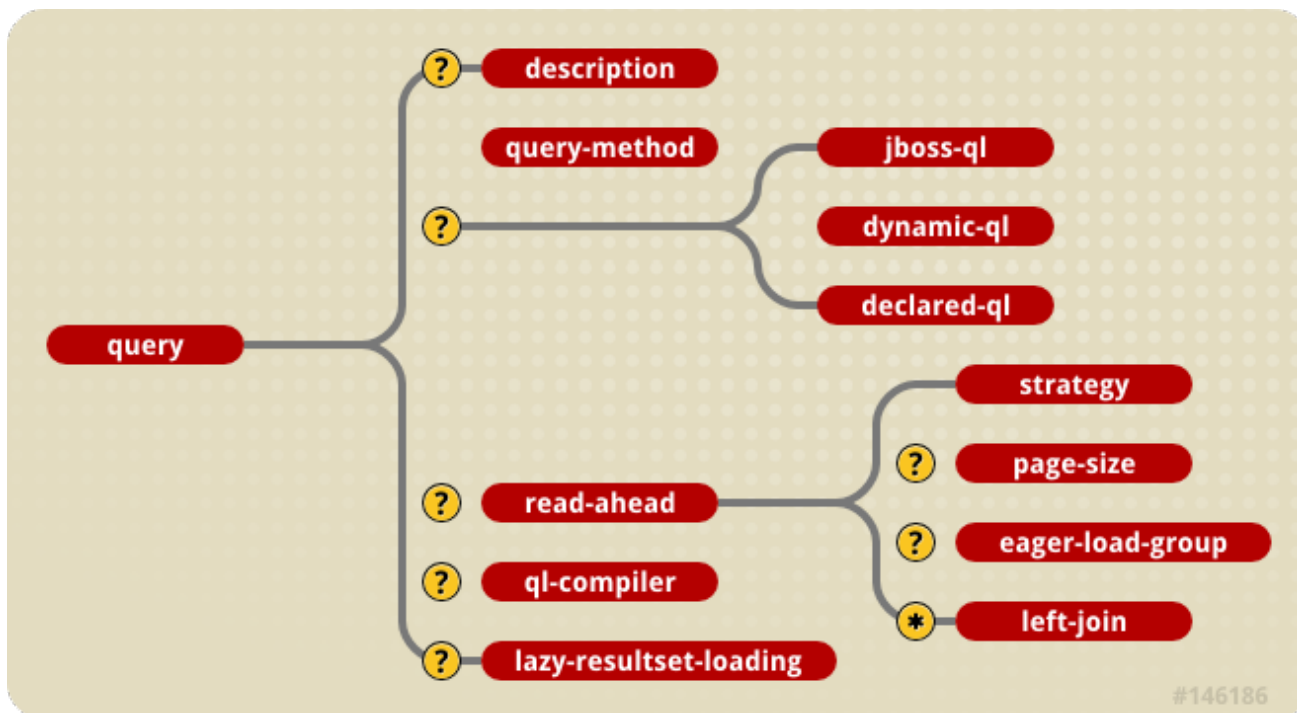

#146186

Figure 31.11. The `jboss-cmp-jdbc` query element content model

- **description:** An optional description for the query.
- **query-method:** This required element specifies the query method that being configured. This must match a `query-method` declared for this entity in the `ejb-jar.xml` file.
- **jboss-ql:** This is a JBossQL query to use in place of the EJB-QL query. JBossQL is discussed in [Section 31.6.4, “JBossQL”](#).
- **dynamic-ql:** This indicated that the method is a dynamic query method and not an EJB-QL query. Dynamic queries are discussed in [Section 31.6.5, “DynamicQL”](#).
- **declared-sql:** This query uses declared SQL in place of the EJB-QL query. Declared SQL is discussed in [Section 31.6.6, “DeclaredSQL”](#).
- **read-ahead:** This optional element allows one to optimize the loading of additional fields for use with the entities referenced by the query. This is discussed in detail in [Section 31.7, “Optimized Loading”](#).

### 31.6.4. JBossQL

JBossQL is a superset of EJB-QL that is designed to address some of the inadequacies of EJB-QL. In addition to a more flexible syntax, new functions, key words, and clauses have been added to JBossQL. At the time of this writing, JBossQL includes support for an **ORDER BY**, **OFFSET** and **LIMIT** clauses, parameters in the **IN** and **LIKE** operators, the **COUNT**, **MAX**, **MIN**, **AVG**, **SUM**, **UCASE** and **LCASE** functions. Queries can also include functions in the **SELECT** clause for select methods.

JBossQL is declared in the `jboss-cmp-jdbc.xml` file with a `jboss-ql` element containing the JBossQL query. The following example provides an example JBossQL declaration.

```

<jboss-cmp-jdbc>
  <enterprise-beans>
    <entity>
      <ejb-name>GangsterEJB</ejb-name>
    
```



```

    <query>
      <query-method>
        <method-name>findBadDudes_jbossql</method-name>
        <method-params>
          <method-param>int</method-param>
        </method-params>
      </query-method>
      <jboss-ql>SELECT OBJECT(g) FROM gangster g WHERE
g.badness > ?1 ORDER BY g.badness DESC</jboss-ql>
    </query>
  </entity>
</enterprise-beans>
</jbosscmp-jdbc>

```

The corresponding generated SQL is straightforward.

```

SELECT t0_g.id
FROM gangster t0_g
WHERE t0_g.badness > ?
ORDER BY t0_g.badness DESC

```

Another capability of JBossQL is the ability to retrieve finder results in blocks using the **LIMIT** and **OFFSET** functions. For example, to iterate through the large number of jobs performed, the following `findManyJobs_jbossql` finder may be defined.

```

<jbosscmp-jdbc>
  <enterprise-beans>
    <entity>
      <ejb-name>GangsterEJB</ejb-name>
      <query>
        <query-method>
          <method-name>findManyJobs_jbossql</method-name>
          <method-params>
            <method-param>int</method-param>
          </method-params>
          <method-params>
            <method-param>int</method-param>
          </method-params>
        </query-method>
        <jboss-ql>SELECT OBJECT(j) FROM jobs j OFFSET ?1 LIMIT ?
2</jboss-ql>
      </query>
    </entity>
  </enterprise-beans>
</jbosscmp-jdbc>

```

### 31.6.5. DynamicQL

DynamicQL allows the runtime generation and execution of JBossQL queries. A DynamicQL query method is an abstract method that takes a JBossQL query and the query arguments as parameters. JBoss compiles the JBossQL and executes the generated SQL. The following generates a JBossQL query that selects all the gangsters that have a hangout in any state in the states set:

```

public abstract class GangsterBean

```

```

implements EntityBean
{
public Set.ejbHomeSelectInStates(Set states)
    throws FinderException
{
    // generate JBossQL query
    StringBuffer jbossQl = new StringBuffer();
    jbossQl.append("SELECT OBJECT(g) ");
    jbossQl.append("FROM gangster g ");
    jbossQl.append("WHERE g.hangout.state IN (");

    for (int i = 0; i < states.size(); i++) {
        if (i > 0) {
            jbossQl.append(", ");
        }

        jbossQl.append("?").append(i+1);
    }

    jbossQl.append(") ORDER BY g.name");

    // pack arguments into an Object[]
    Object[] args = states.toArray(new Object[states.size()]);

    // call dynamic-ql query
    return.ejbSelectGeneric(jbossQl.toString(), args);
}
}

```

The DynamicQL select method may have any valid select method name, but the method must always take a string and an object array as parameters. DynamicQL is declared in the `jbosscmp-jdbc.xml` file with an empty `dynamic-ql` element. The following is the declaration for `ejbSelectGeneric`.

```

<jbosscmp-jdbc>
  <enterprise-beans>
    <entity>
      <ejb-name>GangsterEJB</ejb-name>
      <query>
        <query-method>
          <method-name>ejbSelectGeneric</method-name>
          <method-params>
            <method-param>java.lang.String</method-param>
            <method-param>java.lang.Object[]</method-param>
          </method-params>
        </query-method>
        <dynamic-ql/>
      </query>
    </entity>
  </enterprise-beans>
</jbosscmp-jdbc>

```

### 31.6.6. DeclaredSQL

DeclaredSQL is based on the legacy JAWS CMP 1.1 engine finder declaration, but has been updated for CMP 2.0. Commonly this declaration is used to limit a query with a **WHERE** clause that cannot be

represented in q EJB-QL or JBossQL. The content model for the declared-sql element is given in Figure 31.12, “The jbosscmp-jdbc declared-sql element content model.>” .

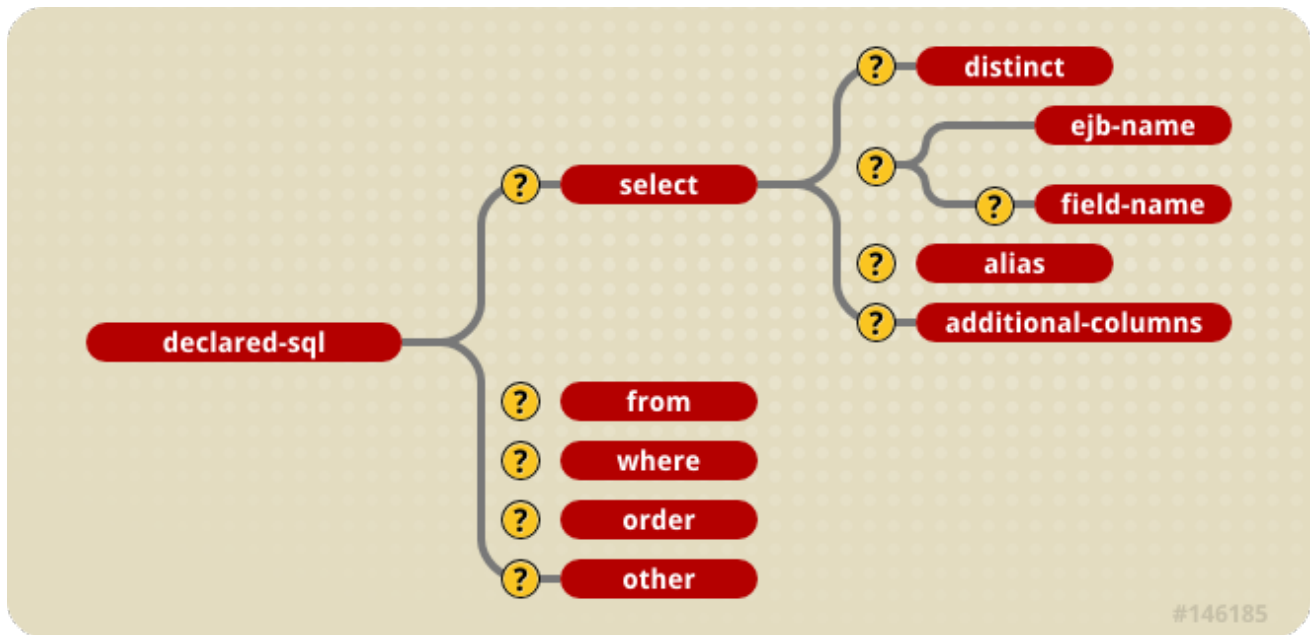

Figure 31.12. The jbosscmp-jdbc declared-sql element content model.>

- **select:** The **select** element specifies what is to be selected and consists of the following elements:
  - **distinct:** If this empty element is present, JBoss will add the **DISTINCT** keyword to the generated **SELECT** clause. The default is to use **DISTINCT** if method returns a `java.util.Set`
  - **ejb-name:** This is the **ejb-name** of the entity that will be selected. This is only required if the query is for a select method.
  - **field-name:** This is the name of the CMP field that will be selected from the specified entity. The default is to select entire entity.
  - **alias:** This specifies the alias that will be used for the main select table. The default is to use the **ejb-name**.
  - **additional-columns:** Declares other columns to be selected to satisfy ordering by arbitrary columns with finders or to facilitate aggregate functions in selects.
- **from:** The **from** element declares additional SQL to append to the generated **FROM** clause.
- **where:** The **where** element declares the **WHERE** clause for the query.
- **order:** The **order** element declares the **ORDER** clause for the query.
- **other:** The **other** element declares additional SQL that is appended to the end of the query.

The following is an example DeclaredSQL declaration.

```

<jbosscmp-jdbc>
  <enterprise-beans>
    <entity>
      <ejb-name>GangsterEJB</ejb-name>
  
```

```

    <query>
      <query-method>
        <method-name>findBadDudes_declaredsql</method-name>
        <method-params>
          <method-param>int</method-param>
        </method-params>
      </query-method>
      <declared-sql>
        <where><![CDATA[ badness > {0} ]]></where>
        <order><![CDATA[ badness DESC ]]></order>
      </declared-sql>
    </query>
  </entity>
</enterprise-beans>
</jbosscomp-jdbc>

```

The generated SQL would be:

```

SELECT id
FROM gangster
WHERE badness > ?
ORDER BY badness DESC

```

As you can see, JBoss generates the **SELECT** and **FROM** clauses necessary to select the primary key for this entity. If desired an additional **FROM** clause can be specified that is appended to the end of the automatically generated **FROM** clause. The following is example DeclaredSQL declaration with an additional **FROM** clause.

```

<jbosscomp-jdbc>
  <enterprise-beans>
    <entity>
      <ejb-name>GangsterEJB</ejb-name>
      <query>
        <query-method>
          <method-name>ejbSelectBoss_declaredsql</method-name>
          <method-params>
            <method-param>java.lang.String</method-param>
          </method-params>
        </query-method>
        <declared-sql>
          <select>
            <distinct/>
            <ejb-name>GangsterEJB</ejb-name>
            <alias>boss</alias>
          </select>
          <from><![CDATA[, gangster g, organization o]]></from>
          <where><![CDATA[
            (LCASE(g.name) = {0} OR LCASE(g.nick_name) = {0})
            AND
            g.organization = o.name AND o.the_boss = boss.id
          ]]></where>
        </declared-sql>
      </query>

```

```

    </entity>
  </enterprise-beans>
</jbosscomp-jdbc>

```

The generated SQL would be:

```

SELECT DISTINCT boss.id
  FROM gangster boss, gangster g, organization o
 WHERE (LCASE(g.name) = ? OR LCASE(g.nick_name) = ?) AND
        g.organization = o.name AND o.the_boss = boss.id

```

Notice that the **FROM** clause starts with a comma. This is because the container appends the declared **FROM** clause to the end of the generated **FROM** clause. It is also possible for the **FROM** clause to start with a SQL **JOIN** statement. Since this is a select method, it must have a **select** element to declare the entity that will be selected. Note that an alias is also declared for the query. If an alias is not declared, the **table-name** is used as the alias, resulting in a **SELECT** clause with the **table\_name.field\_name** style column declarations. Not all database vendors support the that syntax, so the declaration of an alias is preferred. The optional empty **distinct** element causes the **SELECT** clause to use the **SELECT DISTINCT** declaration. The DeclaredSQL declaration can also be used in select methods to select a CMP field.

Now we will see an example which overrides a select to return all of the zip codes an **Organization** operates in.

```

<jbosscomp-jdbc>
  <enterprise-beans>
    <entity>
      <ejb-name>OrganizationEJB</ejb-name>
      <query>
        <query-method>
          <method-
name>ejbSelectOperatingZipCodes_declaredsql</method-name>
          <method-params>
            <method-param>java.lang.String</method-param>
          </method-params>
        </query-method>
        <declared-sql> <select> <distinct/> <ejb-
name>LocationEJB</ejb-name> <field-name>zipCode</field-name>
<alias>hangout</alias> </select> <from><![CDATA[ , organization o,
gangster g ]]></from> <where><![CDATA[ LCASE(o.name) = {0} AND o.name =
g.organization AND g.hangout = hangout.id ]]></where> <order><![CDATA[
hangout.zip ]]></order> </declared-sql>
        </query>
      </entity>
    </enterprise-beans>
  </jbosscomp-jdbc>

```

The corresponding SQL would be:

```

SELECT DISTINCT hangout.zip
  FROM location hangout, organization o, gangster g
 WHERE LCASE(o.name) = ? AND o.name = g.organization AND g.hangout =
hangout.id
        ORDER BY hangout.zip

```

### 31.6.6.1. Parameters

DeclaredSQL uses a completely new parameter handling system, which supports entity and DVC parameters. Parameters are enclosed in curly brackets and use a zero-based index, which is different from the one-based EJB-QL parameters. There are three categories of parameters: simple, DVC, and entity.

- simple:** A simple parameter can be of any type except for a known (mapped) DVC or an entity. A simple parameter only contains the argument number, such as `{0}`. When a simple parameter is set, the JDBC type used to set the parameter is determined by the `datasourcemappping` for the entity. An unknown DVC is serialized and then set as a parameter. Note that most databases do not support the use of a BLOB value in a WHERE clause.
- DVC:** A DVC parameter can be any known (mapped) DVC. A DVC parameter must be dereferenced down to a simple property (one that is not another DVC). For example, if we had a CVS property of type `ContactInfo`, valid parameter declarations would be `{0.email}` and `{0.cell.areaCode}` but not `{0.cell}`. The JDBC type used to set a parameter is based on the class type of the property and the `datasourcemappping` of the entity. The JDBC type used to set the parameter is the JDBC type that is declared for that property in the `dependent-value-class` element.
- entity:** An entity parameter can be any entity in the application. An entity parameter must be dereferenced down to a simple primary key field or simple property of a DVC primary key field. For example, if we had a parameter of type `Gangster`, a valid parameter declaration would be `{0.gangsterId}`. If we had some entity with a primary key field named `info` of type `ContactInfo`, a valid parameter declaration would be `{0.info.cell.areaCode}`. Only fields that are members of the primary key of the entity can be dereferenced (this restriction may be removed in later versions). The JDBC type used to set the parameter is the JDBC type that is declared for that field in the entity declaration.

### 31.6.7. EJBQL 2.1 and SQL92 queries

The default query compiler does not fully support EJB-QL 2.1 or the SQL92 standard. If you need either of these functions, you can replace the query compiler. The default compiler is specified in `standardjbosscmp-jdbc.xml`.

```
<defaults>
  ...
  <ql-compiler>org.jboss.ejb.plugins.cmp.jdbc.JDBCEJBQLCompiler</ql-
compiler>
  ...
</defaults>
```

To use the SQL92 compiler, simply specify the SQL92 compiler in `ql-compiler` element.

```
<defaults>
  ...
  <ql-compiler>org.jboss.ejb.plugins.cmp.jdbc.EJBQLToSQL92Compiler</ql-
compiler>
  ...
</defaults>
```

This changes the query compiler for all beans in the entire system. You can also specify the `ql-compiler` for each element in `jbosscmp-jdbc.xml`. Here is an example using one of our earlier

queries.

```
<query>
  <query-method>
    <method-name>findBadDudes_ejbql</method-name>
    <method-params>
      <method-param>int</method-param>
    </method-params>
  </query-method>
  <ejb-ql><![CDATA[
    SELECT OBJECT(g)
    FROM gangster g
    WHERE g.badness > ?1]]>
  </ejb-ql>
  <ql-compiler>org.jboss.ejb.plugins.cmp.jdbc.EJBQLToSQL92Compiler</ql-
compiler>
</query>
```

One important limitation of SQL92 query compiler is that it always selects all the fields of an entity regardless the **read-ahead** strategy in use. For example, if a query is configured with the **on-loadread-ahead** strategy, the first query will include all the fields, not just primary key fields but only the primary key fields will be read from the **ResultSet**. Then, on load, other fields will be actually loaded into the read-ahead cache. The **on-findread-ahead** with the default load group **\*** works as expected.

### 31.6.8. BMP Custom Finders

JBoss also supports bean managed persistence custom finders. If a custom finder method matches a finder declared in the home or local home interface, JBoss will always call the custom finder over any other implementation declared in the **ejb-jar.xml** or **jbosscmp-jdbc.xml** files. The following simple example finds the entities by a collection of primary keys:

```
public abstract class GangsterBean
  implements EntityBean
{
  public Collection.ejbFindByPrimaryKeys(Collection keys)
  {
    return keys;
  }
}
```

This is a very useful finder because it quickly converts primary keys into real Entity objects without contacting the database. One drawback is that it can create an Entity object with a primary key that does not exist in the database. If any method is invoked on the bad Entity, a **NoSuchEntityException** will be thrown. Another drawback is that the resulting entity bean violates the EJB specification in that it implements a finder, and the JBoss EJB verifier will fail the deployment of such an entity unless the **StrictVerifier** attribute is set to **false**.

## 31.7. OPTIMIZED LOADING

The goal of optimized loading is to load the smallest amount of data required to complete a transaction in the fewest number of queries. The tuning of JBoss depends on a detailed knowledge of the loading process. This section describes the internals of the JBoss loading process and its configuration. Tuning

of the loading process really requires a holistic understanding of the loading system, so this chapter may have to be read more than once.

### 31.7.1. Loading Scenario

The easiest way to investigate the loading process is to look at a usage scenario. The most common scenario is to locate a collection of entities and iterate over the results performing some operation. The following example generates an html table containing all of the gangsters:

```
public String createGangsterHtmlTable_none()
    throws FinderException
{
    StringBuffer table = new StringBuffer();
    table.append("<table>");

    Collection gangsters = gangsterHome.findAll_none();
    for (Iterator iter = gangsters.iterator(); iter.hasNext();) {
        Gangster gangster = (Gangster) iter.next();
        table.append("<tr>");
        table.append("<td>").append(gangster.getName());
        table.append("</td>");
        table.append("<td>").append(gangster.getNickName());
        table.append("</td>");
        table.append("<td>").append(gangster.getBadness());
        table.append("</td>");
        table.append("</tr>");
    }

    return table.toString();
}
```

Assume this code is called within a single transaction and all optimized loading has been disabled. At the `findAll_none` call, JBoss will execute the following query:

```
SELECT t0_g.id
   FROM gangster t0_g
  ORDER BY t0_g.id ASC
```

Then as each of the eight gangster in the sample database is accessed, JBoss will execute the following eight queries:

```
SELECT name, nick_name, badness, hangout, organization
   FROM gangster WHERE (id=0)
SELECT name, nick_name, badness, hangout, organization
   FROM gangster WHERE (id=1)
SELECT name, nick_name, badness, hangout, organization
   FROM gangster WHERE (id=2)
SELECT name, nick_name, badness, hangout, organization
   FROM gangster WHERE (id=3)
SELECT name, nick_name, badness, hangout, organization
   FROM gangster WHERE (id=4)
SELECT name, nick_name, badness, hangout, organization
   FROM gangster WHERE (id=5)
SELECT name, nick_name, badness, hangout, organization
```



```

FROM gangster WHERE (id=6)
SELECT name, nick_name, badness, hangout, organization
FROM gangster WHERE (id=7)

```

There are two problems with this scenario. First, an excessive number of queries are executed because JBoss executes one query for the `findAll` and one query to access each element found. The reason for this behavior has to do with the handling of query results inside the JBoss container. Although it appears that the actual entity beans selected are returned when a query is executed, JBoss really only returns the primary keys of the matching entities, and does not load the entity until a method is invoked on it. This is known as the *n+1* problem and is addressed with the read-ahead strategies described in the following sections.

Second, the values of unused fields are loaded needlessly. JBoss loads the `hangout` and `organization` fields, which are never accessed. (we have disabled the complex `contactInfo` field for the sake of clarity)

The following table shows the execution of the queries:

**Table 31.1. Un-optimized Query Execution**

id	name	nick_name	badness	hangout	organization
0	Yojimbo	Bodyguard	7	0	Yakuza
1	Takeshi	Master	10	1	Yakuza
2	Yuriko	Four finger	4	2	Yakuza
3	Chow	Killer	9	3	Triads
4	Shogi	Lightning	8	4	Triads
5	Valentino	Pizza-Face	4	5	Mafia
6	Toni	Toothless	2	6	Mafia
7	Corleone	Godfather	6	7	Mafia

### 31.7.2. Load Groups

The configuration and optimization of the loading system begins with the declaration of named load groups in the entity. A load group contains the names of CMP fields and CMR Fields that have a foreign key (e.g., `Gangster` in the Organization-Gangster example) that will be loaded in a single operation. An example configuration is shown below:

```

<jbosscmp-jdbc>
  <enterprise-beans>
    <entity>
      <ejb-name>GangsterEJB</ejb-name>
      <!-- ... -->
      <load-groups>
        <load-group>

```

```

        <load-group-name>basic</load-group-name>
        <field-name>name</field-name>
        <field-name>nickName</field-name>
        <field-name>badness</field-name>
    </load-group>
    <load-group>
        <load-group-name>contact info</load-group-name>
        <field-name>nickName</field-name>
        <field-name>contactInfo</field-name>
        <field-name>hangout</field-name>
    </load-group>
</load-groups>
</entity>
</enterprise-beans>
</jbosscomp-jdbc>

```

In this example, two load groups are declared: **basic** and **contact info**. Note that the load groups do not need to be mutually exclusive. For example, both of the load groups contain the **nickName** field. In addition to the declared load groups, JBoss automatically adds a group named **\*** (the star group) that contains every CMP field and CMR field with a foreign key in the entity.

### 31.7.3. Read-ahead

Optimized loading in JBoss is called read-ahead. This refers to the technique of reading the row for an entity being loaded, as well as the next several rows; hence the term read-ahead. JBoss implements two main strategies (**on-find** and **on-load**) to optimize the loading problem identified in the previous section. The extra data loaded during read-ahead is not immediately associated with an entity object in memory, as entities are not materialized in JBoss until actually accessed. Instead, it is stored in the preload cache where it remains until it is loaded into an entity or the end of the transaction occurs. The following sections describe the read-ahead strategies.

#### 31.7.3.1. on-find

The **on-find** strategy reads additional columns when the query is invoked. If the query is **on-find** optimized, JBoss will execute the following query when the query is executed.

```

SELECT t0_g.id, t0_g.name, t0_g.nick_name, t0_g.badness
FROM gangster t0_g
ORDER BY t0_g.id ASC

```

All of the required data would be in the preload cache, so no additional queries would need to be executed while iterating through the query results. This strategy is effective for queries that return a small amount of data, but it becomes very inefficient when trying to load a large result set into memory. The following table shows the execution of this query:

**Table 31.2. on-find Optimized Query Execution**

id	name	nick_name	badness	hangout	organization
0	Yojimbo	Bodyguard	7	0	Yakuza
1	Takeshi	Master	10	1	Yakuza

id	name	nick_name	badness	hangout	organization
2	Yuriko	Four finger	4	2	Yakuza
3	Chow	Killer	9	3	Triads
4	Shogi	Lightning	8	4	Triads
5	Valentino	Pizza-Face	4	5	Mafia
6	Toni	Toothless	2	6	Mafia
7	Corleone	Godfather	6	7	Mafia

The **read-ahead** strategy and **load-group** for a query is defined in the **query** element. If a **read-ahead** strategy is not declared in the **query** element, the strategy declared in the **entity** element or **defaults** element is used. The **on-find** configuration follows:

```
<jbosscmp-jdbc>
  <enterprise-beans>
    <entity>
      <ejb-name>GangsterEJB</ejb-name>
      <!--...-->
      <query>
        <query-method>
          <method-name>findAll_onfind</method-name>
          <method-params/>
        </query-method>
        <jboss-ql><![CDATA[
          SELECT OBJECT(g)
          FROM gangster g
          ORDER BY g.gangsterId
        ]]></jboss-ql>
        <read-ahead>
          <strategy>on-find</strategy>
          <page-size>4</page-size>
          <eager-load-group>basic</eager-load-group>
        </read-ahead>
      </query>
    </entity>
  </enterprise-beans>
</jbosscmp-jdbc>
```

One problem with the **on-find** strategy is that it must load additional data for every entity selected. Commonly in web applications only a fixed number of results are rendered on a page. Since the preloaded data is only valid for the length of the transaction, and a transaction is limited to a single web HTTP hit, most of the preloaded data is not used. The **on-load** strategy discussed in the next section does not suffer from this problem.

### 31.7.3.1.1. Left join read ahead

Left join read ahead is an enhanced **on-findread-ahead** strategy. It allows you to preload in one SQL query not only fields from the base instance but also related instances which can be reached from the base instance by CMR navigation. There are no limitation for the depth of CMR navigations. There are also no limitations for cardinality of CMR fields used in navigation and relationship type mapping, i.e. both foreign key and relation-table mapping styles are supported. Let us look at some examples. Entity and relationship declarations can be found below.

### 31.7.3.1.2. D#findByPrimaryKey

Suppose we have an entity **D**. A typical SQL query generated for the **findByPrimaryKey** would look like this:

```
SELECT t0_D.id, t0_D.name FROM D t0_D WHERE t0_D.id=?
```

Suppose that while executing **findByPrimaryKey** we also want to preload two collection-valued CMR fields **bs** and **cs**.

```
<query>
  <query-method>
    <method-name>findByPrimaryKey</method-name>
    <method-params>
      <method-param>java.lang.Long</method-param>
    </method-params>
  </query-method>
  <jboss-ql><![CDATA[SELECT OBJECT(o) FROM D AS o WHERE o.id = ?
1]]></jboss-ql>
  <read-ahead>
    <strategy>on-find</strategy>
    <page-size>4</page-size>
    <eager-load-group>basic</eager-load-group>
    <left-join cmr-field="bs" eager-load-group="basic"/>
    <left-join cmr-field="cs" eager-load-group="basic"/>
  </read-ahead>
</query>
```

The **left-join** declares the relations to be eager loaded. The generated SQL would look like this:

```
SELECT t0_D.id, t0_D.name,
       t1_D_bs.id, t1_D_bs.name,
       t2_D_cs.id, t2_D_cs.name
FROM D t0_D
     LEFT OUTER JOIN B t1_D_bs ON t0_D.id=t1_D_bs.D_FK
     LEFT OUTER JOIN C t2_D_cs ON t0_D.id=t2_D_cs.D_FK
WHERE t0_D.id=?
```

For the **D** with the specific id we preload all its related **B**'s and **C**'s and can access those instance loading them from the read ahead cache, not from the database.

### 31.7.3.1.3. D#findAll

In the same way, we could optimize the **findAll** method on **D** selects all the **D**'s. A normal **findAll** query would look like this:

```
SELECT DISTINCT t0_o.id, t0_o.name FROM D t0_o ORDER BY t0_o.id DESC
```

To preload the relations, we simply need to add the `left-join` elements to the query.

```
<query>
  <query-method>
    <method-name>findAll</method-name>
  </query-method>
  <jboss-ql><![CDATA[SELECT DISTINCT OBJECT(o) FROM D AS o ORDER BY o.id
DESC]]></jboss-ql>
  <read-ahead>
    <strategy>on-find</strategy>
    <page-size>4</page-size>
    <eager-load-group>basic</eager-load-group>
    <left-join cmr-field="bs" eager-load-group="basic"/>
    <left-join cmr-field="cs" eager-load-group="basic"/>
  </read-ahead>
</query>
```

And here is the generated SQL:

```
SELECT DISTINCT t0_o.id, t0_o.name,
                t1_o_bs.id, t1_o_bs.name,
                t2_o_cs.id, t2_o_cs.name
FROM D t0_o
LEFT OUTER JOIN B t1_o_bs ON t0_o.id=t1_o_bs.D_FK
LEFT OUTER JOIN C t2_o_cs ON t0_o.id=t2_o_cs.D_FK
ORDER BY t0_o.id DESC
```

Now the simple `findAll` query now preloads the related **B** and **C** objects for each **D** object.

#### 31.7.3.1.4. A#findAll

Now let us look at a more complex configuration. Here we want to preload instance **A** along with several relations.

- its parent (self-relation) reached from **A** with CMR field `parent`
- the **B** reached from **A** with CMR field `b`, and the related **C** reached from **B** with CMR field `c`
- **B** reached from **A** but this time with CMR field `b2` and related to it **C** reached from **B** with CMR field `c`.

For reference, the standard query would be:

```
SELECT t0_o.id, t0_o.name FROM A t0_o ORDER BY t0_o.id DESC FOR UPDATE
```

The following metadata describes our preloading plan.

```
<query>
  <query-method>
    <method-name>findAll</method-name>
  </query-method>
  <jboss-ql><![CDATA[SELECT OBJECT(o) FROM A AS o ORDER BY o.id
DESC]]></jboss-ql>
```

```

<read-ahead>
  <strategy>on-find</strategy>
  <page-size>4</page-size>
  <eager-load-group>basic</eager-load-group>
  <left-join cmr-field="parent" eager-load-group="basic"/>
  <left-join cmr-field="b" eager-load-group="basic">
    <left-join cmr-field="c" eager-load-group="basic"/>
  </left-join>
  <left-join cmr-field="b2" eager-load-group="basic">
    <left-join cmr-field="c" eager-load-group="basic"/>
  </left-join>
</read-ahead>
</query>

```

The SQL query generated would be:

```

SELECT t0_o.id, t0_o.name,
       t1_o_parent.id, t1_o_parent.name,
       t2_o_b.id, t2_o_b.name,
       t3_o_b_c.id, t3_o_b_c.name,
       t4_o_b2.id, t4_o_b2.name,
       t5_o_b2_c.id, t5_o_b2_c.name
FROM A t0_o
LEFT OUTER JOIN A t1_o_parent ON t0_o.PARENT=t1_o_parent.id
LEFT OUTER JOIN B t2_o_b ON t0_o.B_FK=t2_o_b.id
LEFT OUTER JOIN C t3_o_b_c ON t2_o_b.C_FK=t3_o_b_c.id
LEFT OUTER JOIN B t4_o_b2 ON t0_o.B2_FK=t4_o_b2.id
LEFT OUTER JOIN C t5_o_b2_c ON t4_o_b2.C_FK=t5_o_b2_c.id
ORDER BY t0_o.id DESC FOR UPDATE

```

With this configuration, you can navigate CMRs from any found instance of **A** without an additional database load.

### 31.7.3.1.5. A#findMeParentGrandParent

Here is another example of self-relation. Suppose, we want to write a method that would preload an instance, its parent, grand-parent and its grand-grand-parent in one query. To do this, we would use nested `left-join` declaration.

```

<query>
  <query-method>
    <method-name>findMeParentGrandParent</method-name>
    <method-params>
      <method-param>java.lang.Long</method-param>
    </method-params>
  </query-method>
  <jboss-ql><![CDATA[SELECT OBJECT(o) FROM A AS o WHERE o.id = ?
1]]></jboss-ql>
  <read-ahead>
    <strategy>on-find</strategy>
    <page-size>4</page-size>
    <eager-load-group>*</eager-load-group>
    <left-join cmr-field="parent" eager-load-group="basic">
      <left-join cmr-field="parent" eager-load-group="basic">
        <left-join cmr-field="parent" eager-load-group="basic"/>
      </left-join>
    </left-join>
  </read-ahead>
</query>

```

```

        </left-join>
    </left-join>
</read-ahead>
</query>

```

The generated SQL would be:

```

SELECT t0_o.id, t0_o.name, t0_o.secondName, t0_o.B_FK, t0_o.B2_FK,
t0_o.PARENT,
    t1_o_parent.id, t1_o_parent.name,
    t2_o_parent_parent.id, t2_o_parent_parent.name,
    t3_o_parent_parent_parent.id, t3_o_parent_parent_parent.name
FROM A t0_o
    LEFT OUTER JOIN A t1_o_parent ON t0_o.PARENT=t1_o_parent.id
    LEFT OUTER JOIN A t2_o_parent_parent ON
t1_o_parent.PARENT=t2_o_parent_parent.id
    LEFT OUTER JOIN A t3_o_parent_parent_parent
    ON t2_o_parent_parent.PARENT=t3_o_parent_parent_parent.id
WHERE (t0_o.id = ?) FOR UPDATE

```

Note, if we remove `left-join` metadata we will have only

```

SELECT t0_o.id, t0_o.name, t0_o.secondName, t0_o.B2_FK, t0_o.PARENT FOR
UPDATE

```

### 31.7.3.2. on-load

The `on-load` strategy block-loads additional data for several entities when an entity is loaded, starting with the requested entity and the next several entities in the order they were selected. This strategy is based on theory that the results of a find or select will be accessed in forward order. When a query is executed, JBoss stores the order of the entities found in the list cache. Later, when one of the entities is loaded, JBoss uses this list to determine the block of entities to load. The number of lists stored in the cache is specified with the `list-cachemax` element of the entity. This strategy is also used when faulting in data not loaded in the `on-find` strategy.

As with the `on-find` strategy, `on-load` is declared in the `read-ahead` element. The `on-load` configuration for this example is shown below.

```

<jbosscmp-jdbc>
  <enterprise-beans>
    <entity>
      <ejb-name>GangsterEJB</ejb-name>
      <!-- ... -->
      <query>
        <query-method>
          <method-name>findAll_onload</method-name>
          <method-params/>
        </query-method>
        <jboss-ql><![CDATA[
          SELECT OBJECT(g)
          FROM gangster g
          ORDER BY g.gangsterId
        ]]></jboss-ql>
      <read-ahead>

```

```

        <strategy>on-load</strategy>
        <page-size>4</page-size>
        <eager-load-group>basic</eager-load-group>
    </read-ahead>
</query>
</entity>
</enterprise-beans>
</jbosscomp-jdbc>

```

With this strategy, the query for the finder method in remains unchanged.

```

SELECT t0_g.id
FROM gangster t0_g
ORDER BY t0_g.id ASC

```

However, the data will be loaded differently as we iterate through the result set. For a page size of four, JBoss will only need to execute the following two queries to load the `name`, `nickName` and `badness` fields for the entities:

```

SELECT id, name, nick_name, badness
FROM gangster
WHERE (id=0) OR (id=1) OR (id=2) OR (id=3)
SELECT id, name, nick_name, badness
FROM gangster
WHERE (id=4) OR (id=5) OR (id=6) OR (id=7)

```

The following table shows the execution of these queries:

**Table 31.3. on-load Optimized Query Execution**

id	name	nick_name	badness	hangout	organization
0	Yojimbo	Bodyguard	7	0	Yakuza
1	Takeshi	Master	10	1	Yakuza
2	Yuriko	Four finger	4	2	Yakuza
3	Chow	Killer	9	3	Triads
4	Shogi	Lightning	8	4	Triads
5	Valentino	Pizza-Face	4	5	Mafia
6	Toni	Toothless	2	6	Mafia
7	Corleone	Godfather	6	7	Mafia

### 31.7.3.3. none

The `none` strategy is really an anti-strategy. This strategy causes the system to fall back to the default



lazy-load code, and specifically does not read-ahead any data or remember the order of the found entities. This results in the queries and performance shown at the beginning of this chapter. The none strategy is declared with a read-ahead element. If the `read-ahead` element contains a `page-size` element or `eager-load-group`, it is ignored. The none strategy is declared the following example.

```
<jbosscmp-jdbc>
  <enterprise-beans>
    <entity>
      <ejb-name>GangsterEJB</ejb-name>
      <!-- ... -->
      <query>
        <query-method>
          <method-name>findAll_none</method-name>
          <method-params/>
        </query-method>
        <jboss-ql><![CDATA[
          SELECT OBJECT(g)
          FROM gangster g
          ORDER BY g.gangsterId
        ]]></jboss-ql>
        <read-ahead>
          <strategy>none</strategy>
        </read-ahead>
      </query>
    </entity>
  </enterprise-beans>
</jbosscmp-jdbc>
```

## 31.8. LOADING PROCESS

In the previous section several steps use the phrase "when the entity is loaded." This was intentionally left vague because the commit option specified for the entity and the current state of the transaction determine when an entity is loaded. The following section describes the commit options and the loading processes.

### 31.8.1. Commit Options

Central to the loading process are the commit options, which control when the data for an entity expires. JBoss supports four commit options A, B, C and D. The first three are described in the Enterprise JavaBeans Specification, but the last one is specific to JBoss. A detailed description of each commit option follows:

- **A:** JBoss assumes it is the sole user of the database; therefore, JBoss can cache the current value of an entity between transactions, which can result in substantial performance gains. As a result of this assumption, no data managed by JBoss can be changed outside of JBoss. For example, changing data in another program or with the use of direct JDBC (even within JBoss) will result in an inconsistent database state.
- **B:** JBoss assumes that there is more than one user of the database but keeps the context information about entities between transactions. This context information is used for optimizing loading of the entity. This is the default commit option.
- **C:** JBoss discards all entity context information at the end of the transaction.

- **D:** This is a JBoss specific commit option. This option is similar to commit option **A**, except that the data only remains valid for a specified amount of time.

The commit option is declared in the `jboss.xml` file. For a detailed description of this file see [Chapter 30, EJBs on JBoss](#). The following example changes the commit option to **A** for all entity beans in the application:

### Example 31.2. The `jboss.xml` Commit Option Declaration

```
<jboss>
  <container-configurations>
    <container-configuration>
      <container-name>Standard CMP 2.x EntityBean</container-
name>
      <commit-option>A</commit-option>
    </container-configuration>
  </container-configurations>
</jboss>
```

## 31.8.2. Eager-loading Process

When an entity is loaded, JBoss must determine the fields that need to be loaded. By default, JBoss will use the **eager-load-group** of the last query that selected this entity. If the entity has not been selected in a query, or the last query used the **none** read-ahead strategy, JBoss will use the default **eager-load-group** declared for the entity. In the following example configuration, the **basic** load group is set as the default **eager-load-group** for the **gangster** entity bean:

```
<jbosscmp-jdbc>
  <enterprise-beans>
    <entity>
      <ejb-name>GangsterEJB</ejb-name>
      <!-- ... -->
      <load-groups>
        <load-group>
          <load-group-name>most</load-group-name>
          <field-name>name</field-name>
          <field-name>nickName</field-name>
          <field-name>badness</field-name>
          <field-name>hangout</field-name>
          <field-name>organization</field-name>
        </load-group>
      </load-groups>
      <eager-load-group>most</eager-load-group>
    </entity>
  </enterprise-beans>
</jbosscmp-jdbc>
```

The eager loading process is initiated the first time a method is called on an entity in a transaction. A detailed description of the load process follows:

1. If the entity context is still valid, no loading is necessary, and therefore the loading process is done. The entity context will be valid when using commit option **A**, or when using commit option **D**, and the data has not timed out.

2. Any residual data in the entity context is flushed. This assures that old data does not bleed into the new load.
3. The primary key value is injected back into the primary key fields. The primary key object is actually independent of the fields and needs to be reloaded after the flush in step 2.
4. All data in the preload cache for this entity is loaded into the fields.
5. JBoss determines the additional fields that still need to be loaded. Normally the fields to load are determined by the eager-load group of the entity, but can be overridden if the entity was located using a query or CMR field with an `on-find` or `on-load` read ahead strategy. If all of the fields have already been loaded, the load process skips to step 7.
6. A query is executed to select the necessary column. If this entity is using the `on-load` strategy, a page of data is loaded as described in [Section 31.7.3.2, “on-load”](#). The data for the current entity is stored in the context and the data for the other entities is stored in the preload cache.
7. The `ejbLoad` method of the entity is called.

### 31.8.3. Lazy loading Process

Lazy loading is the other half of eager loading. If a field is not eager loaded, it must be lazy loaded. When an access to an unloaded field of a bean is made, JBoss loads the field and all the fields of any `lazy-load-group` the field belong to. JBoss performs a set join and then removes any field that is already loaded. An example configuration is shown below.

```
<jbosscmp-jdbc>
  <enterprise-beans>
    <entity>
      <ejb-name>GangsterEJB</ejb-name>
      <!-- ... -->
      <load-groups>
        <load-group>
          <load-group-name>basic</load-group-name>
          <field-name>name</field-name>
          <field-name>nickName</field-name>
          <field-name>badness</field-name>
        </load-group>
        <load-group>
          <load-group-name>contact info</load-group-name>
          <field-name>nickName</field-name>
          <field-name>contactInfo</field-name>
          <field-name>hangout</field-name>
        </load-group>
      </load-groups>
      <!-- ... -->
      <lazy-load-groups>
        <load-group-name>basic</load-group-name>
        <load-group-name>contact info</load-group-name>
      </lazy-load-groups>
    </entity>
  </enterprise-beans>
</jbosscmp-jdbc>
```

When the bean provider calls `getName()` with this configuration, JBoss loads `name`, `nickName` and

**badness**, assuming they are not already loaded. When the bean provider calls `getNickName()`, the **name**, **nickName**, **badness**, **contactInfo**, and **hangout** are loaded. A detailed description of the lazy loading process follows:

1. All data in the preload cache for this entity is loaded into the fields.
2. If the field value was loaded by the preload cache the lazy load process is finished.
3. JBoss finds all of the lazy load groups that contain this field, performs a set join on the groups, and removes any field that has already been loaded.
4. A query is executed to select the necessary columns. As in the basic load process, JBoss may load a block of entities. The data for the current entity is stored in the context and the data for the other entities is stored in the preload cache.

### 31.8.3.1. Relationships

Relationships are a special case in lazy loading because a CMR field is both a field and query. As a field it can be **on-load** block loaded, meaning the value of the currently sought entity and the values of the CMR field for the next several entities are loaded. As a query, the field values of the related entity can be preloaded using **on-find**.

Again, the easiest way to investigate the loading is to look at a usage scenario. In this example, an HTML table is generated containing each gangster and their hangout. The example code follows:

#### Example 31.3. Relationship Lazy Loading Example Code

```
public String createGangsterHangoutHtmlTable()
    throws FinderException
{
    StringBuffer table = new StringBuffer();
    table.append("<table>");
    Collection gangsters = gangsterHome.findAll_onfind();
    for (Iterator iter = gangsters.iterator(); iter.hasNext(); ) {
        Gangster gangster = (Gangster)iter.next();

        Location hangout = gangster.getHangout();
        table.append("<tr>");
        table.append("<td>").append(gangster.getName());
        table.append("</td>");
        table.append("<td>").append(gangster.getNickName());
        table.append("</td>");
        table.append("<td>").append(gangster.getBadness());
        table.append("</td>");
        table.append("<td>").append(hangout.getCity());
        table.append("</td>");
        table.append("<td>").append(hangout.getState());
        table.append("</td>");
        table.append("<td>").append(hangout.getZipCode());
        table.append("</td>");
        table.append("</tr>");
    }

    table.append("</table>");return table.toString();
}
```

For this example, the configuration of the gangster's `findAll_onfind` query is unchanged from the `on-find` section. The configuration of the `Location` entity and `Gangster-Hangout` relationship follows:

#### Example 31.4. The `jbosscmp-jdbc.xml` Relationship Lazy Loading Configuration

```
<jbosscmp-jdbc>
  <enterprise-beans>
    <entity>
      <ejb-name>LocationEJB</ejb-name>
      <load-groups>
        <load-group>
          <load-group-name>quick info</load-group-name>
          <field-name>city</field-name>
          <field-name>state</field-name>
          <field-name>zipCode</field-name>
        </load-group>
      </load-groups>
      <eager-load-group/>
    </entity>
  </enterprise-beans>
  <relationships>
    <ejb-relation>
      <ejb-relation-name>Gangster-Hangout</ejb-relation-name>
      <foreign-key-mapping/>
      <ejb-relationship-role>
        <ejb-relationship-role-name>
          gangster-has-a-hangout
        </ejb-relationship-role-name>
        <key-fields/>
        <read-ahead>
          <strategy>on-find</strategy>
          <page-size>4</page-size>
          <eager-load-group>quick info</eager-load-group>
        </read-ahead>
      </ejb-relationship-role>
      <ejb-relationship-role>
        <ejb-relationship-role-name>
          hangout-for-a-gangster
        </ejb-relationship-role-name>
        <key-fields>
          <key-field>
            <field-name>locationID</field-name>
            <column-name>hangout</column-name>
          </key-field>
        </key-fields>
      </ejb-relationship-role>
    </ejb-relation>
  </relationships>
</jbosscmp-jdbc>
```

JBoss will execute the following query for the finder:

```
SELECT t0_g.id, t0_g.name, t0_g.nick_name, t0_g.badness
FROM gangster t0_g
ORDER BY t0_g.id ASC
```

Then when the hangout is accessed, JBoss executes the following two queries to load the `city`, `state`, and `zip` fields of the hangout:

```
SELECT gangster.id, gangster.hangout,
       location.city, location.st, location.zip
FROM gangster, location
WHERE (gangster.hangout=location.id) AND
      ((gangster.id=0) OR (gangster.id=1) OR
       (gangster.id=2) OR (gangster.id=3))
SELECT gangster.id, gangster.hangout,
       location.city, location.st, location.zip
FROM gangster, location
WHERE (gangster.hangout=location.id) AND
      ((gangster.id=4) OR (gangster.id=5) OR
       (gangster.id=6) OR (gangster.id=7))
```

The following table shows the execution of the queries:

**Table 31.4. on-find Optimized Relationship Query Execution**

id	name	nick_name	badness	hangout	id	city	st	zip
0	Yojimbo	Bodyguard	7	0	0	San Fran	CA	94108
1	Takeshi	Master	10	1	1	San Fran	CA	94133
2	Yuriko	Four finger	4	2	2	San Fran	CA	94133
3	Chow	Killer	9	3	3	San Fran	CA	94133
4	Shogi	Lightning	8	4	4	San Fran	CA	94133
5	Valentino	Pizza-Face	4	5	5	New York	NY	10017
6	Toni	Toothless	2	6	6	Chicago	IL	60661
7	Corleone	Godfather	6	7	7	Las Vegas	NV	89109

### 31.8.4. Lazy loading result sets

By default, when a multi-object finder or select method is executed the JDBC result set is read to the end immediately. The client receives a collection of `EJBLocalObject` or CMP field values which it can then iterate through. For big result sets this approach is not efficient. In some cases it is better to delay reading the next row in the result set until the client tries to read the corresponding value from the collection. You can get this behavior for a query using the `lazy-resultset-loading` element.

```
<query>
  <query-method>
    <method-name>findAll</method-name>
  </query-method>
  <jboss-ql><![CDATA[select object(o) from A o]]></jboss-ql>
  <lazy-resultset-loading>true</lazy-resultset-loading>
</query>
```

There are some issues you should be aware of when using lazy result set loading. Special care should be taken when working with a `Collection` associated with a lazily loaded result set. The first call to `iterator()` returns a special `Iterator` that reads from the `ResultSet`. Until this `Iterator` has been exhausted, subsequent calls to `iterator()` or calls to the `add()` method will result in an exception. The `remove()` and `size()` methods work as would be expected.

## 31.9. TRANSACTIONS

All of the examples presented in this chapter have been defined to run in a transaction. Transaction granularity is a dominating factor in optimized loading because transactions define the lifetime of preloaded data. If the transaction completes, commits, or rolls back, the data in the preload cache is lost. This can result in a severe negative performance impact.

The performance impact of running without a transaction will be demonstrated with an example that uses an `on-find` optimized query that selects the first four gangsters (to keep the result set small), and it is executed without a wrapper transaction. The example code follows:

```
public String createGangsterHtmlTable_no_tx() throws FinderException
{
    StringBuffer table = new StringBuffer();
    table.append("<table>");

    Collection gangsters = gangsterHome.findFour();
    for(Iterator iter = gangsters.iterator(); iter.hasNext(); ) {
        Gangster gangster = (Gangster)iter.next();
        table.append("<tr>");
        table.append("<td>").append(gangster.getName());
        table.append("</td>");
        table.append("<td>").append(gangster.getNickName());
        table.append("</td>");
        table.append("<td>").append(gangster.getBadness());
        table.append("</td>");
        table.append("</tr>");
    }

    table.append("</table>");
    return table.toString();
}
```

The finder results in the following query being executed:

```
SELECT t0_g.id, t0_g.name, t0_g.nick_name, t0_g.badness
FROM gangster t0_g
WHERE t0_g.id < 4
ORDER BY t0_g.id ASC
```

Normally this would be the only query executed, but since this code is not running in a transaction, all of the preloaded data is thrown away as soon as finder returns. Then when the CMP field is accessed JBoss executes the following four queries (one for each loop):

```
SELECT id, name, nick_name, badness
FROM gangster
WHERE (id=0) OR (id=1) OR (id=2) OR (id=3)
SELECT id, name, nick_name, badness
FROM gangster
WHERE (id=1) OR (id=2) OR (id=3)
SELECT id, name, nick_name, badness
FROM gangster
WHERE (id=2) OR (id=3)
SELECT name, nick_name, badness
FROM gangster
WHERE (id=3)
```

It is actually worse than this. JBoss executes each of these queries three times; once for each CMP field that is accessed. This is because the preloaded values are discarded between the CMP field accessor calls.

The following figure shows the execution of the queries:



Figure 31.13. No Transaction on-find optimized query execution

This performance is much worse than *read ahead none* because of the amount of data loaded from the database. The number of rows loaded is determined by the following equation:

#### Example 31.5.

$$n + n - 1 + n - 2 + \dots + 1 + = ((n \cdot (n+1)) / 2) = O(n^2)$$

This all happens because the transaction in the example is bounded by a single call on the entity. This brings up the important question "How do I run my code in a transaction?" The answer depends on



where the code runs. If it runs in an EJB (session, entity, or message driven), the method must be marked with the **Required** or **RequiresNewtrans-attribute** in the **assembly-descriptor**. If the code is not running in an EJB, a user transaction is necessary. The following code wraps a call to the declared method with a user transaction:

```
public String createGangsterHtmlTable_with_tx()
    throws FinderException
{
    UserTransaction tx = null;
    try {
        InitialContext ctx = new InitialContext();
        tx = (UserTransaction) ctx.lookup("UserTransaction");
        tx.begin();

        String table = createGangsterHtmlTable_no_tx();

        if (tx.getStatus() == Status.STATUS_ACTIVE) {
            tx.commit();
        }
        return table;
    } catch (Exception e) {
        try {
            if (tx != null) tx.rollback();
        } catch (SystemException unused) {
            // eat the exception we are exceptioning out anyway
        }
        if (e instanceof FinderException) {
            throw (FinderException) e;
        }
        if (e instanceof RuntimeException) {
            throw (RuntimeException) e;
        }

        throw new EJBException(e);
    }
}
```

## 31.10. OPTIMISTIC LOCKING

JBoss has supports for optimistic locking of entity beans. Optimistic locking allows multiple instances of the same entity bean to be active simultaneously. Consistency is enforced based on the optimistic locking policy choice. The optimistic locking policy choice defines the set of fields that are used in the commit time write of modified data to the database. The optimistic consistency check asserts that the values of the chosen set of fields has the same values in the database as existed when the current transaction was started. This is done using a **select for UPDATE WHERE ...** statement that contains the value assertions.

You specify the optimistic locking policy choice using an **optimistic-locking** element in the **jbosscmp-jdbc.xml** descriptor. The content model of the **optimistic-locking** element is shown below and the description of the elements follows.

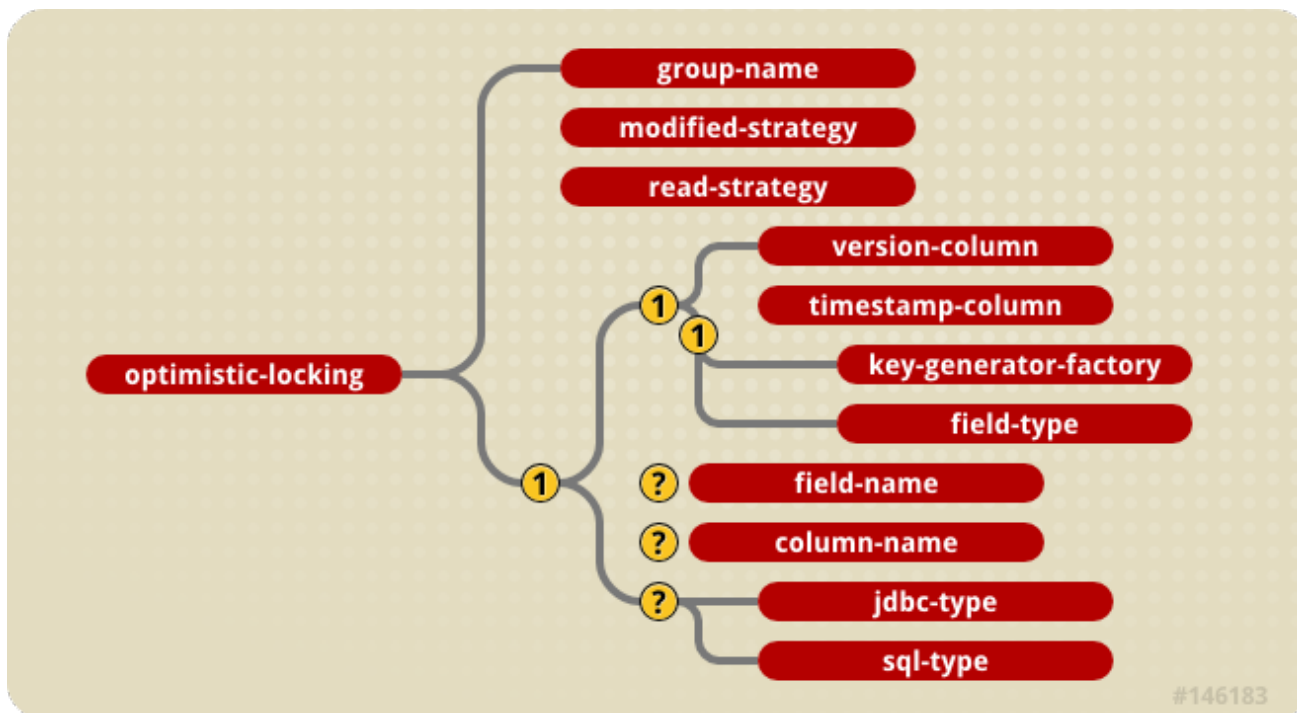

Figure 31.14. The `jbosscmp-jdbc` `optimistic-locking` element content model

- group-name:** This element specifies that optimistic locking is based on the fields of a `load-group`. This value of this element must match one of the entity's `load-group-name`. The fields in this group will be used for optimistic locking.
- modified-strategy:** This element specifies that optimistic locking is based on the modified fields. This strategy implies that the fields that were modified during transaction will be used for optimistic locking.
- read-strategy:** This element specifies that optimistic locking is based on the fields read. This strategy implies that the fields that were read/changed in the transaction will be used for optimistic locking.
- version-column:** This element specifies that optimistic locking is based on a version column strategy. Specifying this element will add an additional version field of type `java.lang.Long` to the entity bean for optimistic locking. Each update of the entity will increase the value of this field. The `field-name` element allows for the specification of the name of the CMP field while the `column-name` element allows for the specification of the corresponding table column.
- timestamp-column:** This element specifies that optimistic locking is based on a timestamp column strategy. Specifying this element will add an additional version field of type `java.util.Date` to the entity bean for optimistic locking. Each update of the entity will set the value of this field to the current time. The `field-name` element allows for the specification of the name of the CMP field while the `column-name` element allows for the specification of the corresponding table column.
- key-generator-factory:** This element specifies that optimistic locking is based on key generation. The value of the element is the JNDI name of a `org.jboss.ejb.plugins.keygenerator.KeyGeneratorFactory` implementation. Specifying this element will add an additional version field to the entity bean for optimistic locking. The type of the field must be specified via the `field-type` element. Each update of

the entity will update the key field by obtaining a new value from the key generator. The `field-name` element allows for the specification of the name of the CMP field while the `column-name` element allows for the specification of the corresponding table column.

A sample `jbosscmp-jdbc.xml` descriptor illustrating all of the optimistic locking strategies is given below.

```
<!DOCTYPE jbosscmp-jdbc PUBLIC
"-//JBoss//DTD JBOSSCMP-JDBC 3.2//EN"
"http://www.jboss.org/j2ee/dtd/jbosscmp-jdbc_3_2.dtd">
<jbosscmp-jdbc>
  <defaults>
    <datasource>java:/DefaultDS</datasource>
    <datasource-mapping>Hypersonic SQL</datasource-mapping>
  </defaults>
  <enterprise-beans>
    <entity>
      <ejb-name>EntityGroupLocking</ejb-name>
      <create-table>true</create-table>
      <remove-table>true</remove-table>
      <table-name>entitygrouplocking</table-name>
      <cmp-field>
        <field-name>dateField</field-name>
      </cmp-field>
      <cmp-field>
        <field-name>integerField</field-name>
      </cmp-field>
      <cmp-field>
        <field-name>stringField</field-name>
      </cmp-field>
      <load-groups>
        <load-group>
          <load-group-name>string</load-group-name>
          <field-name>stringField</field-name>
        </load-group>
        <load-group>
          <load-group-name>all</load-group-name>
          <field-name>stringField</field-name>
          <field-name>dateField</field-name>
        </load-group>
      </load-groups>
      <optimistic-locking>
        <group-name>string</group-name>
      </optimistic-locking>
    </entity>
    <entity>
      <ejb-name>EntityModifiedLocking</ejb-name>
      <create-table>true</create-table>
      <remove-table>true</remove-table>
      <table-name>entitymodifiedlocking</table-name>
      <cmp-field>
        <field-name>dateField</field-name>
      </cmp-field>
      <cmp-field>
        <field-name>integerField</field-name>
      </cmp-field>
```

```

    <cmp-field>
      <field-name>stringField</field-name>
    </cmp-field>
  </optimistic-locking>
    <modified-strategy/>
  </optimistic-locking>
</entity>
<entity>
  <ejb-name>EntityReadLocking</ejb-name>
  <create-table>true</create-table>
  <remove-table>true</remove-table>
  <table-name>entityreadlocking</table-name>
  <cmp-field>
    <field-name>dateField</field-name>
  </cmp-field>
  <cmp-field>
    <field-name>integerField</field-name>
  </cmp-field>
  <cmp-field>
    <field-name>stringField</field-name>
  </cmp-field>
  <optimistic-locking>
    <read-strategy/>
  </optimistic-locking>
</entity>
<entity>
  <ejb-name>EntityVersionLocking</ejb-name>
  <create-table>true</create-table>
  <remove-table>true</remove-table>
  <table-name>entityversionlocking</table-name>
  <cmp-field>
    <field-name>dateField</field-name>
  </cmp-field>
  <cmp-field>
    <field-name>integerField</field-name>
  </cmp-field>
  <cmp-field>
    <field-name>stringField</field-name>
  </cmp-field>
  <optimistic-locking>
    <version-column/>
    <field-name>versionField</field-name>
    <column-name>ol_version</column-name>
    <jdbc-type>INTEGER</jdbc-type>
    <sql-type>INTEGER(5)</sql-type>
  </optimistic-locking>
</entity>
<entity>
  <ejb-name>EntityTimestampLocking</ejb-name>
  <create-table>true</create-table>
  <remove-table>true</remove-table>
  <table-name>entitytimestamplocking</table-name>
  <cmp-field>
    <field-name>dateField</field-name>
  </cmp-field>
  <cmp-field>

```

```

        <field-name>integerField</field-name>
    </cmp-field>
    <cmp-field>
        <field-name>stringField</field-name>
    </cmp-field>
    <optimistic-locking>
        <timestamp-column/>
        <field-name>versionField</field-name>
        <column-name>ol_timestamp</column-name>
        <jdbc-type>TIMESTAMP</jdbc-type>
        <sql-type>DATETIME</sql-type>
    </optimistic-locking>
</entity>
<entity>
    <ejb-name>EntityKeyGeneratorLocking</ejb-name>
    <create-table>true</create-table>
    <remove-table>true</remove-table>
    <table-name>entitykeygenlocking</table-name>
    <cmp-field>
        <field-name>dateField</field-name>
    </cmp-field>
    <cmp-field>
        <field-name>integerField</field-name>
    </cmp-field>
    <cmp-field>
        <field-name>stringField</field-name>
    </cmp-field>
    <optimistic-locking>
        <key-generator-factory>UUIDKeyGeneratorFactory</key-
generator-factory>
        <field-type>java.lang.String</field-type>
        <field-name>uuidField</field-name>
        <column-name>ol_uuid</column-name>
        <jdbc-type>VARCHAR</jdbc-type>
        <sql-type>VARCHAR(32)</sql-type>
    </optimistic-locking>
</entity>
</enterprise-beans>
</jbossCMP-jdbc>

```

## 31.11. ENTITY COMMANDS AND PRIMARY KEY GENERATION

Support for primary key generation outside of the entity bean is available through custom implementations of the entity creation command objects used to insert entities into a persistent store. The list of available commands is specified in `entity-commands` element of the `jbossCMP-jdbc.xml` descriptor. The default `entity-command` may be specified in the `jbossCMP-jdbc.xml` in `defaults` element. Each entity element can override the `entity-command` in `defaults` by specifying its own `entity-command`. The content model of the `entity-commands` and child elements is given below.

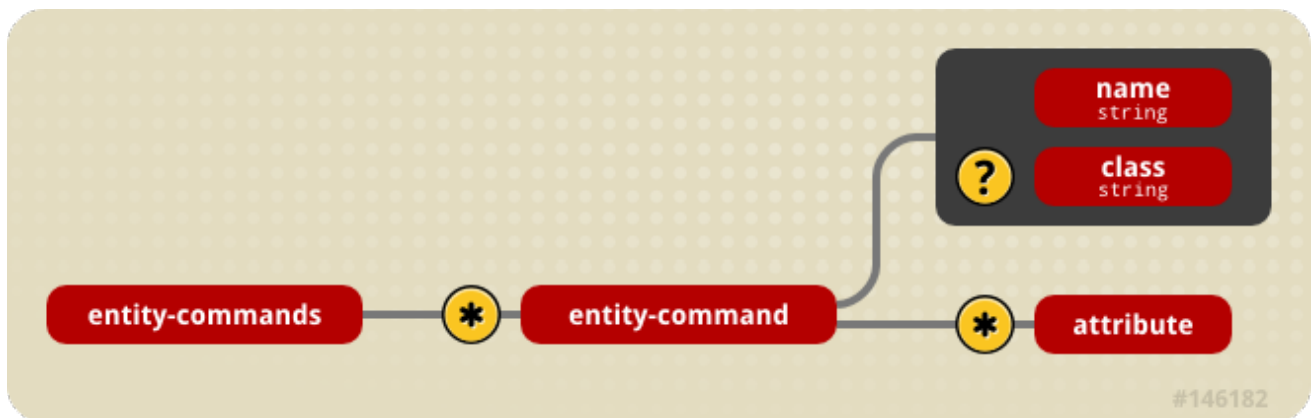

Figure 31.15. The `jbossCMP-jdbc.xml` `entity-commands` element model

Each `entity-command` element specifies an entity generation implementation. The `name` attribute specifies a name that allows the command defined in an `entity-commands` section to be referenced in the defaults and entity elements. The `class` attribute specifies the implementation of the `org.jboss.ejb.plugins.cmp.jdbc.JDBCCreateEntityCommand` that supports the key generation. Database vendor specific commands typically subclass the `org.jboss.ejb.plugins.cmp.jdbc.JDBCIdentityColumnCreateCommand` if the database generates the primary key as a side effect of doing an insert, or the `org.jboss.ejb.plugins.cmp.jdbc.JDBCInsertPKCreateCommand` if the command must insert the generated key.

The optional `attribute` element(s) allows for the specification of arbitrary name/value property pairs that will be available to the entity command implementation class. The `attribute` element has a required `name` attribute that specifies the name property, and the `attribute` element content is the value of the property. The attribute values are accessible through the `org.jboss.ejb.plugins.cmp.jdbc.metadata.JDBCEntityCommandMetaData.getAttribute(String)` method.

### 31.11.1. Existing Entity Commands

The following are the current `entity-command` definitions found in the `standardjbossCMP-jdbc.xml` descriptor:

- default:** (`org.jboss.ejb.plugins.cmp.jdbc.JDBCCreateEntityCommand`) The `JDBCCreateEntityCommand` is the default entity creation as it is the `entity-command` referenced in the `standardjbossCMP-jdbc.xml` defaults element. This entity-command executes an `INSERT INTO` query using the assigned primary key value.
- no-select-before-insert:** (`org.jboss.ejb.plugins.cmp.jdbc.JDBCCreateEntityCommand`) This is a variation on default that skips select before insert by specifying an attribute `name="SQLExceptionProcessor"` that points to the `jboss.jdbc:service=SQLExceptionProcessor` service. The `SQLExceptionProcessor` service provides a `boolean isDuplicateKey(SQLException e)` operation that allows a for determination of any unique constraint violation.
- pk-sql** (`org.jboss.ejb.plugins.cmp.jdbc.keygen.JDBCPkSqlCreateCommand`) The `JDBCPkSqlCreateCommand` executes an `INSERT INTO` query statement provided by the `pk-sql` attribute to obtain the next primary key value. Its primary target usage are databases with sequence support.

- **mysql-get-generated-keys:**  
(`org.jboss.ejb.plugins.cmp.jdbc.keygen.JDBCMySQLCreateCommand`) The `JDBCMySQLCreateCommand` executes an `INSERT INTO` query using the `getGeneratedKeys` method from MySQL native `java.sql.Statement` interface implementation to fetch the generated key.
- **oracle-sequence:**  
(`org.jboss.ejb.plugins.cmp.jdbc.keygen.JDBCOracleCreateCommand`) The `JDBCOracleCreateCommand` is a create command for use with Oracle that uses a sequence in conjunction with a `RETURNING` clause to generate keys in a single statement. It has a required `sequence` element that specifies the name of the sequence column.
- **hsqldb-fetch-key:**  
(`org.jboss.ejb.plugins.cmp.jdbc.keygen.JDBCHsqldbCreateCommand`) The `JDBCHsqldbCreateCommand` executes an `INSERT INTO` query after executing a `CALL IDENTITY()` statement to fetch the generated key.
- **sybase-fetch-key:**  
(`org.jboss.ejb.plugins.cmp.jdbc.keygen.JDBCSybaseCreateCommand`) The `JDBCSybaseCreateCommand` executes an `INSERT INTO` query after executing a `SELECT @@IDENTITY` statement to fetch the generated key.
- **mssql-fetch-key:**  
(`org.jboss.ejb.plugins.cmp.jdbc.keygen.JDBCSQLServerCreateCommand`) The `JDBCSQLServerCreateCommand` for Microsoft SQL Server that uses the value from an `IDENTITY` columns. By default uses `SELECT SCOPE_IDENTITY()` to reduce the impact of triggers; can be overridden with `pk-sql` attribute e.g. for V7.
- **informix-serial:**  
(`org.jboss.ejb.plugins.cmp.jdbc.keygen.JDBCInformixCreateCommand`) The `JDBCInformixCreateCommand` executes an `INSERT INTO` query after using the `getSerial` method from Informix native `java.sql.Statement` interface implementation to fetch the generated key.
- **postgresql-fetch-seq:**  
(`org.jboss.ejb.plugins.cmp.jdbc.keygen.JDBCPostgreSQLCreateCommand`) The `JDBCPostgreSQLCreateCommand` for PostgreSQL that fetches the current value of the sequence. The optional `sequence` attribute can be used to change the name of the sequence, with the default being `table_pkColumn_seq`.
- **key-generator:**  
(`org.jboss.ejb.plugins.cmp.jdbc.keygen.JDBCKeyGeneratorCreateCommand`) The `JDBCKeyGeneratorCreateCommand` executes an `INSERT INTO` query after obtaining a value for the primary key from the key generator referenced by the `key-generator-factory`. The `key-generator-factory` attribute must provide the name of a JNDI binding of the `org.jboss.ejb.plugins.keygenerator.KeyGeneratorFactory` implementation.
- **get-generated-keys:**  
(`org.jboss.ejb.plugins.cmp.jdbc.jdbc3.JDBCGetGeneratedKeysCreateCommand`) The `JDBCGetGeneratedKeysCreateCommand` executes an `INSERT INTO` query using a statement built using the JDBC3 `prepareStatement(String, Statement.RETURN_GENERATED_KEYS)` that has the capability to retrieve the auto-generated key. The generated key is obtained by calling the `PreparedStatement.getGeneratedKeys` method. Since this requires JDBC3 support it is

only available in JDK1.4.1+ with a supporting JDBC driver.

An example configuration using the `hsqldb-fetch-keyentity-command` with the generated key mapped to a known primary key `cmp-field` is shown below.

```
<jbosscmp-jdbc>
  <enterprise-beans>
    <entity>
      <ejb-name>LocationEJB</ejb-name>
      <pk-constraint>>false</pk-constraint>
      <table-name>location</table-name>

      <cmp-field>
        <field-name>locationID</field-name>
        <column-name>id</column-name>
        <auto-increment/>
      </cmp-field>
      <!-- ... -->
      <entity-command name="hsqldb-fetch-key"/>

    </entity>
  </enterprise-beans>
</jbosscmp-jdbc>
```

An alternate example using an unknown primary key without an explicit `cmp-field` is shown below.

```
<jbosscmp-jdbc>
  <enterprise-beans>
    <entity>
      <ejb-name>LocationEJB</ejb-name>
      <pk-constraint>>false</pk-constraint>
      <table-name>location</table-name>
      <unknown-pk>
        <unknown-pk-class>java.lang.Integer</unknown-pk-class>
        <field-name>locationID</field-name>
        <column-name>id</column-name>
        <jdbc-type>INTEGER</jdbc-type>
        <sql-type>INTEGER</sql-type>
        <auto-increment/>
      </unknown-pk>
      <!-- ... -->
      <entity-command name="hsqldb-fetch-key"/>
    </entity>
  </enterprise-beans>
</jbosscmp-jdbc>
```

## 31.12. DEFAULTS

JBoss global defaults are defined in the `standardjbosscmp-jdbc.xml` file of the `server/<server-name>/conf/` directory. Each application can override the global defaults in the `jbosscmp-jdbc.xml` file. The default options are contained in a `defaults` element of the configuration file, and the content model is shown below.



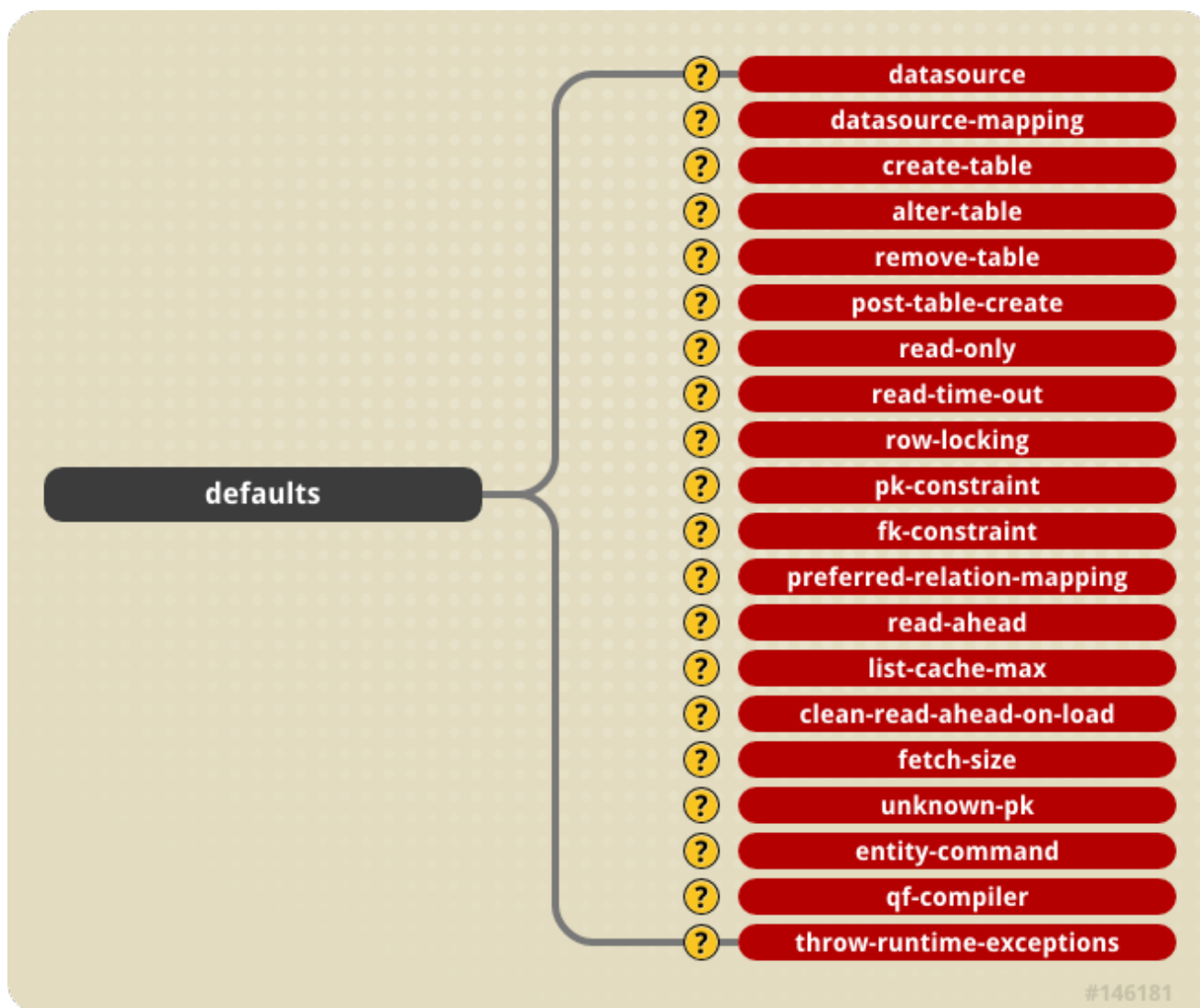

Figure 31.16. The `jbosscmp-jdbc.xml` defaults content model

An example of the defaults section follows:

```
<jbosscmp-jdbc>
  <defaults>
    <datasource>java:/DefaultDS</datasource>
    <datasource-mapping>Hypersonic SQL</datasource-mapping>
    <create-table>true</create-table>
    <remove-table>false</remove-table>
    <read-only>false</read-only>
    <read-time-out>300000</read-time-out>
    <pk-constraint>true</pk-constraint>
    <fk-constraint>false</fk-constraint>
    <row-locking>false</row-locking>
    <preferred-relation-mapping>foreign-key</preferred-relation-
mapping>
    <read-ahead>
      <strategy>on-load</strategy>
      <page-size>1000</page-size>
      <eager-load-group>*</eager-load-group>
    </read-ahead>
    <list-cache-max>1000</list-cache-max>
  </defaults>
</jbosscmp-jdbc>
```

### 31.12.1. A sample jbosscmp-jdbc.xml defaults declaration

Each option can apply to entities, relationships, or both, and can be overridden in the specific entity or relationship. A detailed description of each option follows:

- **datasource:** This optional element is the `jndi-name` used to look up the datasource. All database connections used by an entity or `relation-table` are obtained from the datasource. Having different datasources for entities is not recommended, as it vastly constrains the domain over which finders and `ejbSelects` can query.
- **datasource-mapping:** This optional element specifies the name of the `type-mapping`, which determines how Java types are mapped to SQL types, and how EJB-QL functions are mapped to database specific functions. Type mappings are discussed in [Section 31.13.3, “Mapping”](#).
- **create-table:** This optional element when true, specifies that JBoss should attempt to create a table for the entity. When the application is deployed, JBoss checks if a table already exists before creating the table. If a table is found, it is logged, and the table is not created. This option is very useful during the early stages of development when the table structure changes often. The default is false.
- **alter-table:** If `create-table` is used to automatically create the schema, `alter-table` can be used to keep the schema current with changes to the entity bean. Alter table will perform the following specific tasks:
  - new fields will be created
  - fields which are no longer used will be removed
  - string fields which are shorter than the declared length will have their length increased to the declared length. (not supported by all databases)
- **remove-table:** This optional element when true, JBoss will attempt to drop the table for each entity and each relation table mapped relationship. When the application is undeployed, JBoss will attempt to drop the table. This option is very useful during the early stages of development when the table structure changes often. The default is false.
- **read-only:** This optional element when true specifies that the bean provider will not be allowed to change the value of any fields. A field that is read-only will not be stored in, or inserted into, the database. If a primary key field is read-only, the create method will throw a `CreateException`. If a set accessor is called on a `read-only` field, it throws an `EJBException`. Read only fields are useful for fields that are filled in by database triggers, such as last update. The `read-only` option can be overridden on a per field basis. The default is false.
- **read-time-out:** This optional element is the amount of time in milliseconds that a read on a read only field is valid. A value of 0 means that the value is always reloaded at the start of a transaction, and a value of -1 means that the value never times out. This option can also be overridden on a per CMP field basis. If `read-only` is false, this value is ignored. The default is -1.
- **row-locking:** This optional element if true specifies that JBoss will lock all rows loaded in a transaction. Most databases implement this by using the `SELECT FOR UPDATE` syntax when loading the entity, but the actual syntax is determined by the `row-locking-template` in the `datasource-mapping` used by this entity. The default is false.

- **pk-constraint:** This optional element if true specifies that JBoss will add a primary key constraint when creating tables. The default is true.
- **preferred-relation-mapping:** This optional element specifies the preferred mapping style for relationships. The `preferred-relation-mapping` element must be either `foreign-key` or `relation-table`.
- **read-ahead:** This optional element controls caching of query results and CMR fields for the entity. This option is discussed in [Section 31.7.3, “Read-ahead”](#).
- **list-cache-max:** This optional element specifies the number of `read-lists` that can be tracked by this entity. This option is discussed in [Section 31.7.3.2, “on-load”](#). The default is 1000.
- **clean-read-ahead-on-load:** When an entity is loaded from the read ahead cache, JBoss can remove the data used from the read ahead cache. The default is `false`.
- **fetch-size:** This optional element specifies the number of entities to read in one round-trip to the underlying datastore. The default is 0.
- **unknown-pk:** This optional element allows one to define the default mapping of an unknown primary key type of `java.lang.Object` maps to the persistent store.
- **entity-command:** This optional element allows one to define the default command for entity creation. This is described in detail in [Section 31.11, “Entity Commands and Primary Key Generation”](#).
- **ql-compiler:** This optional elements allows a replacement query compiler to be specified. Alternate query compilers were discussed in [Section 31.6.7, “EJBQL 2.1 and SQL92 queries”](#).
- **throw-runtime-exceptions:** This attribute, if set to true, indicates that an error in connecting to the database should be seen in the application as runtime `EJBException` rather than as a checked exception.

## 31.13. DATASOURCE CUSTOMIZATION

JBoss includes predefined type-mappings for many databases including: Cloudscape, DB2, DB2/400, Hypersonic SQL, InformixDB, InterBase, MS SQLSERVER, MS SQLSERVER2000, MySQL, Oracle7, Oracle8, Oracle9i, PointBase, PostgreSQL, PostgreSQL 7.2, SapDB, SOLID, and Sybase. If you do not like the supplied mapping, or a mapping is not supplied for your database, you will have to define a new mapping. If you find an error in one of the supplied mappings, or if you create a new mapping for a new database, please consider posting a patch at the JBoss project page on SourceForge.

### 31.13.1. Type Mapping

Customization of a database is done through the `type-mapping` section of the `jbosscmp-jdbc.xml` descriptor. The content model for the type-mapping element is given in [Figure 31.17, “The jbosscmp-jdbc type-mapping element content model.”](#)

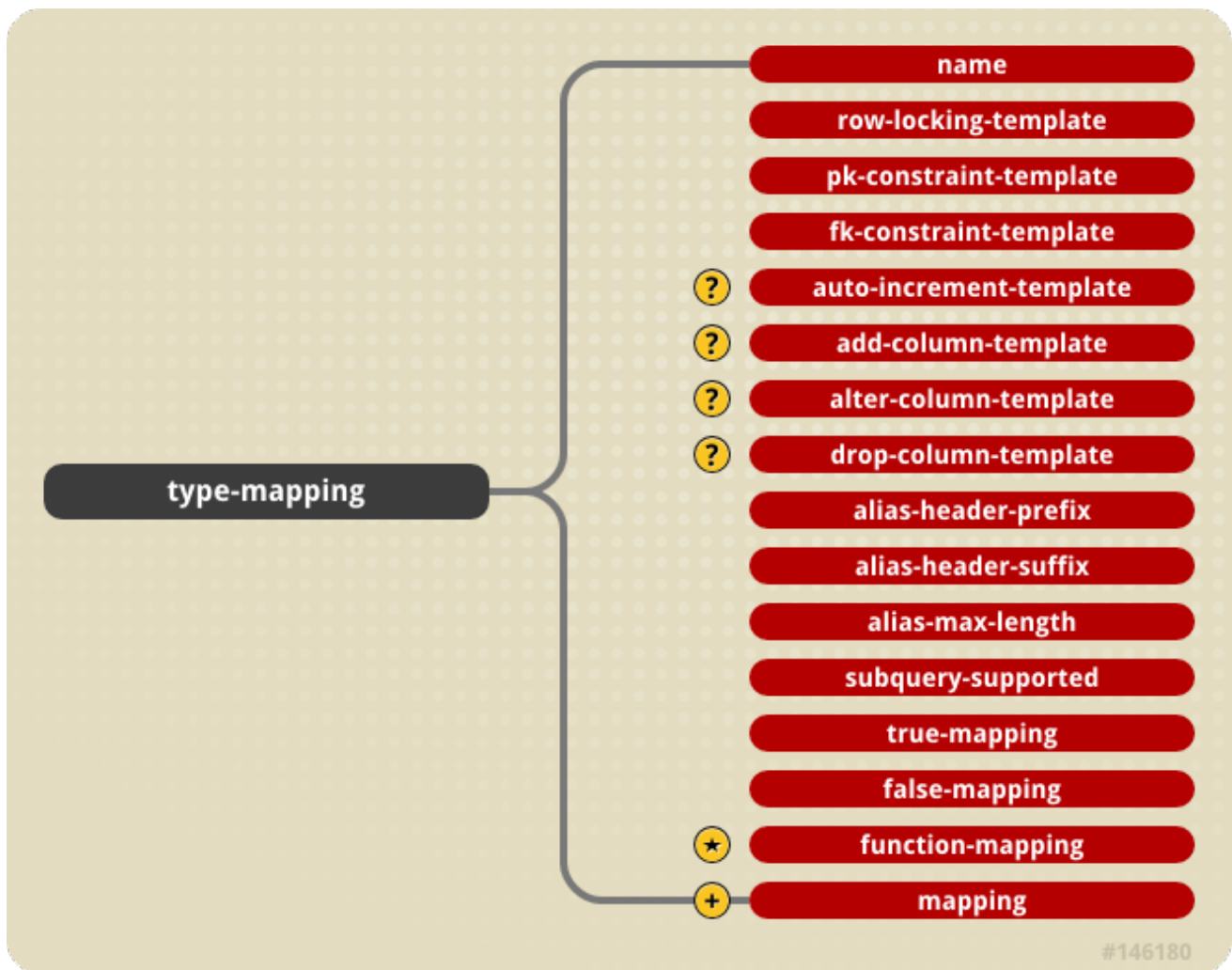

Figure 31.17. The jbossCMP-jdbc type-mapping element content model.

The elements are:

- **name:** This required element provides the name identifying the database customization. It is used to refer to the mapping by the **datasource-mapping** elements found in defaults and entity.
- **row-locking-template:** This required element gives the **PreparedStatement** template used to create a row lock on the selected rows. The template must support three arguments:
  1. the select clause
  2. the from clause. The order of the tables is currently not guaranteed
  3. the where clause

If row locking is not supported in select statement this element should be empty. The most common form of row locking is select for update as in: **SELECT ?1 FROM ?2 WHERE ?3 FOR UPDATE.**

- **pk-constraint-template:** This required element gives the **PreparedStatement** template used to create a primary key constraint in the create table statement. The template must support two arguments
  1. Primary key constraint name; which is always **pk\_{table-name}**

2. Comma separated list of primary key column names

If a primary key constraint clause is not supported in a create table statement this element should be empty. The most common form of a primary key constraint is: **CONSTRAINT ?1 PRIMARY KEY (?2)**

- **fk-constraint-template:** This is the template used to create a foreign key constraint in separate statement. The template must support five arguments:
  1. Table name
  2. Foreign key constraint name; which is always `fk_{table-name}_{cmr-field-name}`
  3. Comma separated list of foreign key column names
  4. References table name
  5. Comma separated list of the referenced primary key column names

If the datasource does not support foreign key constraints this element should be empty. The most common form of a foreign key constraint is: **ALTER TABLE ?1 ADD CONSTRAINT ?2 FOREIGN KEY (?3) REFERENCES ?4 (?5).**

- **auto-increment-template:** This declares the SQL template for specifying auto increment columns.
- **add-column-template:** When `alter-table` is true, this SQL template specifies the syntax for adding a column to an existing table. The default value is **ALTER TABLE ?1 ADD ?2 ?3.** The parameters are:
  1. the table name
  2. the column name
  3. the column type
- **alter-column-template:** When `alter-table` is true, this SQL template specifies the syntax for dropping a column to from an existing table. The default value is **ALTER TABLE ?1 ALTER ?2 TYPE ?3.** The parameters are:
  1. the table name
  2. the column name
  3. the column type
- **drop-column-template:** When `alter-table` is true, this SQL template specifies the syntax for dropping a column to from an existing table. The default value is **ALTER TABLE ?1 DROP ?2.** The parameters are:
  1. the table name
  2. the column name
- **alias-header-prefix:** This required element gives the prefix used in creating the alias header. An alias header is prepended to a generated table alias by the EJB-QL compiler to prevent name collisions. The alias header is constructed as follows: `alias-header-prefix + int_counter +`

alias-header-suffix. An example alias header would be `t0_` for an alias-header-prefix of "t" and an alias-header-suffix of "\_".

- **alias-header-suffix:** This required element gives the suffix portion of the generated alias header.
- **alias-max-length:** This required element gives the maximum allowed length for the generated alias header.
- **subquery-supported:** This required element specifies if this `type-mapping` subqueries as either true or false. Some EJB-QL operators are mapped to exists subqueries. If `subquery-supported` is false, the EJB-QL compiler will use a left join and is null.
- **true-mapping:** This required element defines *true* identity in EJB-QL queries. Examples include `TRUE`, `1`, and `(1=1)`.
- **false-mapping:** This required element defines *false* identity in EJB-QL queries. Examples include `FALSE`, `0`, and `(1=0)`.
- **function-mapping:** This optional element specifies one or more the mappings from an EJB-QL function to an SQL implementation. See [Section 31.13.2, "Function Mapping"](#) for the details.
- **mapping:** This required element specifies the mappings from a Java type to the corresponding JDBC and SQL type. See [Section 31.13.3, "Mapping"](#) for the details.

### 31.13.2. Function Mapping

The function-mapping element model is show below.

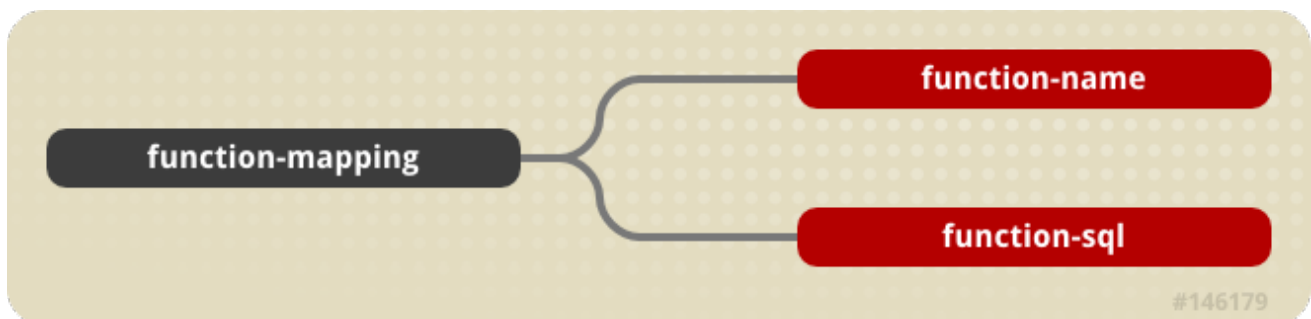

Figure 31.18. The `jbosscmp-jdbc` function-mapping element content model

The allowed child elements are:

- **function-name:** This required element gives the EJB-QL function name, e.g., `concat`, `substring`.
- **function-sql:** This required element gives the SQL for the function as appropriate for the underlying database. Examples for a `concat` function include: `(?1 || ?2)`, `concat(?1, ?2)`, `(?1 + ?2)`.

### 31.13.3. Mapping

A `type-mapping` is simply a set of mappings between Java class types and database types. A set of type mappings is defined by a set of `mapping` elements, the content model for which is shown in [Figure 31.19, "The `jbosscmp-jdbc` mapping element content model."](#)

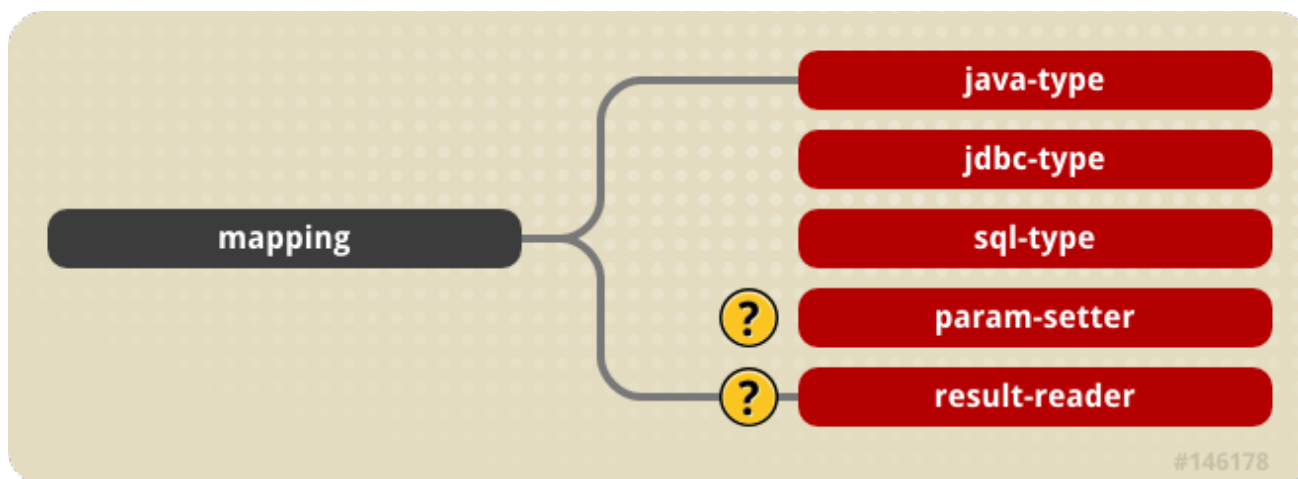

#146178

Figure 31.19. The `jbosscmp-jdbc` mapping element content model.

If JBoss cannot find a mapping for a type, it will serialize the object and use the `java.lang.Object` mapping. The following describes the three child elements of the mapping element:

- **java-type:** This required element gives the fully qualified name of the Java class to be mapped. If the class is a primitive wrapper class such as `java.lang.Short`, the mapping also applies to the primitive type.
- **jdbc-type:** This required element gives the JDBC type that is used when setting parameters in a JDBC `PreparedStatement` or loading data from a JDBC `ResultSet`. The valid types are defined in `java.sql.Types`.
- **sql-type:** This required element gives the SQL type that is used in create table statements. Valid types are only limited by your database vendor.
- **param-setter:** This optional element specifies the fully qualified name of the `JDBCParameterSetter` implementation for this mapping.
- **result-reader:** This optional element specifies the fully qualified name of the `JDBCResultSetReader` implementation for this mapping.

An example mapping element for a short in Oracle9i is shown below.

```

<jbosscmp-jdbc>
  <type-mappings>
    <type-mapping>
      <name>Oracle9i</name>
      <!--...-->
      <mapping>
        <java-type>java.lang.Short</java-type>
        <jdbc-type>NUMERIC</jdbc-type>
        <sql-type>NUMBER(5)</sql-type>
      </mapping>
    </type-mapping>
  </type-mappings>
</jbosscmp-jdbc>

```

### 31.13.4. User Type Mappings

User type mappings allow one to map from JDBC column types to custom CMP fields types by specifying an instance of `org.jboss.ejb.plugins.cmp.jdbc.Mapper` interface, the definition of which is shown below.

```
public interface Mapper
{
    /**
     * This method is called when CMP field is stored.
     * @param fieldValue - CMP field value
     * @return column value.
     */
    Object toColumnValue(Object fieldValue);

    /**
     * This method is called when CMP field is loaded.
     * @param columnValue - loaded column value.
     * @return CMP field value.
     */
    Object toFieldValue(Object columnValue);
}
```

A prototypical use case is the mapping of an integer type to its type-safe Java enumeration instance. The content model of the `user-type-mappings` element consists of one or more `user-type-mapping` elements, the content model of which is shown in [Figure 31.20, “The user-type-mapping content model >”](#).

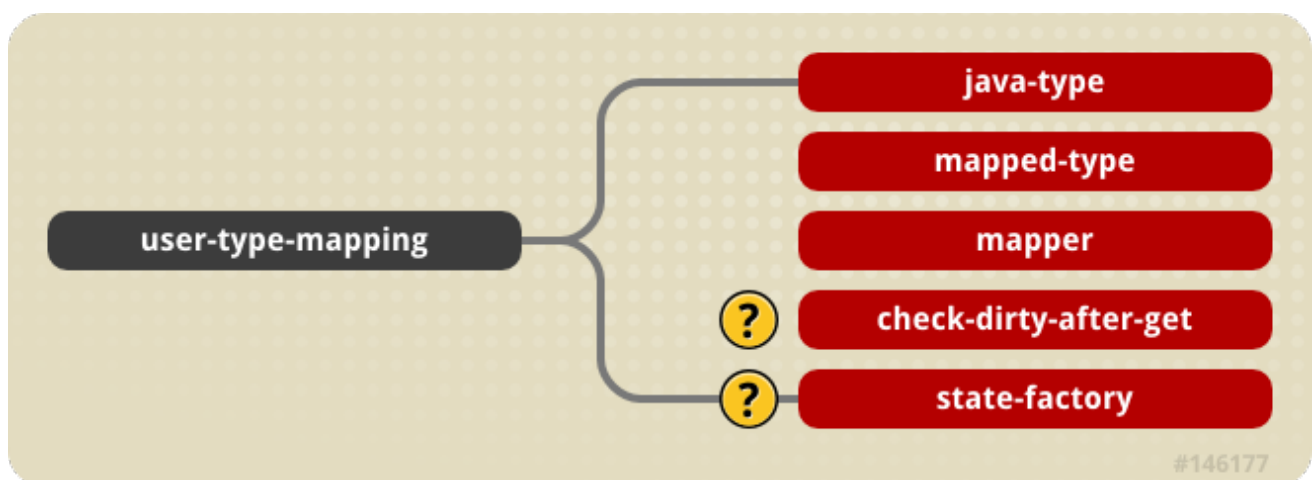

Figure 31.20. The user-type-mapping content model >

- **java-type:** the fully qualified name of the CMP field type in the mapping.
- **mapped-type:** the fully qualified name of the database type in the mapping.
- **mapper:** the fully qualified name of the `Mapper` interface implementation that handles the conversion between the `java-type` and `mapped-type`.



## PART V. APPENDICES

## APPENDIX A. SERVER DIRECTORY STRUCTURE

If you used the zip installation method, installing JBoss Enterprise Application Platform creates a top level directory named `jboss-eap-<version>`.

If you used the GUI installer, you have defined a custom directory named during installation. In this guide we refer to this top-level directory as the `<$JBOSS_HOME>` directory.

Table A.1. `<JBOSS_HOME>/jboss-as` directory structure

Directory	Description	Important Notes
bin	Contains start up, shut down and other system-specific scripts. Basically all the entry point JARs and start scripts included with the JBoss distribution are located in the bin directory. It also contains the configuration scripts which can be used to configure the JVM parameters.	
client	Stores configuration files and JAR files that may be used by a Java client application (running outside JBoss) or an external web container. You can select archives as required or use <code>jbossall-client.jar</code> .	<p>Unlike early versions of the JBoss Enterprise Application Platform, the <code>jbossall-client.jar</code> is now a <b>MANIFEST</b> only JAR file.</p> <p>So if the client application copies over the <code>jbossall-client.jar</code> to its classpath, then it also has to copy over all the other jar files listed in the <b>META-INF/MANIFEST.MF</b> file of <code>jbossall-client.jar</code>.</p> <p>Furthermore, all these JARs, including the <code>jbossall-client.jar</code>, must be placed in the same folder in the client classpath.</p>
common	<p>The <code>lib</code> sub-directory within this <b>common</b> directory, contains all the JAR files which are common to the server configuration sets.</p> <p>Keeping all common JAR files in one place (rather than in the <code>lib</code> folder of each of the server configuration) reduces the size of the server. It also helps with maintenance as there are fewer files to maintain.</p>	<p>Like some of the other configuration paths, the <b>common</b> and the <code>common/lib</code> directories are available as the system properties</p> <p><code>jboss.common.base.url</code> (This holds the URL to <code>&lt;JBOSS_HOME&gt;/jboss-as/common</code> directory) and</p> <p><code>jboss.common.lib.url</code> (This holds the URL to <code>&lt;JBOSS_HOME&gt;/jboss-as/common/lib</code> directory).</p>

Directory	Description	Important Notes
docs	<p>Contains the XML DTDs, schemas used in JBoss for reference (these are also a useful source of documentation on JBoss configuration specifics).</p> <p>This directory also contains example JCA (Java Connector Architecture) configuration files for setting up datasources for different databases (such as MySQL, Oracle, Postgres).</p>	
lib	<p>Contains start up JARs used by JBoss. This directory contains an <i>endorsed</i> sub-directory which is used as one of the Java Endorsed directories. Refer to the <a href="#">Java Endorsed Standards</a> for more details. <b>Do not place your own JAR files in these directories.</b></p>	
server	<p>Contains the server profile sets discussed above. Each of the subdirectories is a different server profile. JBoss ships with <b>minimal, default, production, standard, web</b> and <b>all</b> profile sets. The subdirectories and key configuration files contained in the <b>default</b> profile set are discussed in more detail in subsequent sections.</p>	



### IMPORTANT

Do not remove any configuration or JRA files from the **common** directory location. You may add your own JAR files in the **common/lib** directory *if* those JAR files are meant to be used by all the server profile sets.

If you want the JAR files to be available for all the applications deployed in a single server profile (for example, the **production** profile), then the best location to place these JARs is the `<JBOSS_HOME>/server/<PROFILE>/lib` directory.

## A.1. SERVER PROFILE DIRECTORY STRUCTURE

The directory server profile you are using is effectively the server root while JBoss is running. It contains all the code and configuration information for the services provided by the particular server profile.

It is also where the log output goes and where you deploy applications. The table below shows the directories inside the server profile directory (`<JBOSS_HOME>/server/<PROFILE>`) and their functions.

**Table A.2. Server Profile Directory Structure**

Directory	Description
<b>conf</b>	<p>The <b>conf</b> directory contains the <b>jboss-service.xml</b>, <b>bootstrap.xml</b> bootstrap descriptor file for a given server profile.</p> <p>The <b>bootstrap.xml</b> in turn points to various other configuration files which comprise the server bootstrap. This defines the core microcontainer beans that are fixed for the lifetime of the server.</p>
<b>deploy</b>	<p>The <b>deploy</b> directory contains the hot-deployable services (those which can be added to or removed from the running server). It also contains applications for the current server profile.</p> <p>You deploy your application code by placing application packages (JAR, WAR and EAR files) in the <b>deploy</b> directory.</p> <p>The directory is constantly scanned for updates, and any modified components will be re-deployed automatically.</p> <p>The directory monitored may be configured with the applicationURIs property of the <b>BootstrapProfileFactory</b> bean configuration in the <code>&lt;JBOSS_HOME&gt;/jboss-as/server/&lt;PROFILE&gt;/conf/bootstrap/profile.xml</code> file.</p>
<b>deployers</b>	<p>In Enterprise Application Platform 5, unlike earlier versions, the deployers (which are responsible for parsing and deploying applications) are located separately in the <code>&lt;JBOSS_HOME&gt;/jboss-as/server/&lt;PROFILE&gt;/deployers</code> folder. This folder contains various deployer JAR files and their configurations in <code>*-jboss-beans.xml</code> files.</p>
<b>lib</b>	<p>This directory contains JAR files (Java libraries that should not be hot deployed) needed by this server profile. You can add required library files for JDBC drivers and other requirements to this directory.</p> <p>All JARs in this directory are loaded into the shared classpath at start up. Note that this directory only contains those jars unique to the server profile. Jars common across the server profiles are now located in <code>&lt;JBOSS_HOME&gt;/common/lib</code>.</p>



### IMPORTANT

The file used for configuring the default set of ports for the server is available in the `<PROFILE>/conf/bindingservice.beans/META-INF` folder. The name of the file is `bindings-jboss-beans.xml`. See the port configuration section for more details on how to use this file.

#### A.1.1. The default Server Profile File Set

The default server profile file set is located in the `<JBOSS_HOME>/server/default` directory.

Many of the items in the `default` profile are found in other pre-configured profile. The sections below will discuss some of these files, their location and their use.

### A.1.1.1. Contents of conf directory

The files in the `conf` directory are explained in the following table.

Table A.3. Contents of conf directory

File	Description
<code>bindingservice.beans/*</code>	This directory contains the configurations for various ports used by the server.
<code>bootstrap.xml</code>	This is the <code>bootstrap.xml</code> file that defines which additional microcontainer deployments will be loaded as part of the bootstrap phase.
<code>bootstrap/*</code>	This directory contains the microcontainer bootstrap descriptors that are referenced from the <code>bootstrap.xml</code> file.
<code>jboss-service.xml</code>	<code>jboss-service.xml</code> legacy core mbeans that have yet to be ported to either bootstrap deployments, or deploy services. This file will likely be deprecated in the near future.
<code>jboss-log4j.xml</code>	This file configures the Apache log4j framework category priorities and appenders used by the server code.
<code>jbossts-properties.xml</code>	This file provides the default configuration for the transaction manager.
<code>login-config.xml</code>	This file contains sample server side authentication configurations that are applicable when using JAAS based security.
<code>props/*</code>	The <code>props</code> directory contains the users and roles property files for the <code>jmx-console</code> .
<code>standardjboss.xml</code>	This file provides the default container configurations.
<code>standardjbosscomp-jdbc.xml</code>	This file provides a default configuration file for the JBoss CMP engine.
<code>xmdesc/*-mbean.xml</code>	The <code>xmdesc</code> directory contains XMLElement descriptors for several services configured in the <code>jboss-service.xml</code> file.

File	Description
<code>java.policy</code>	
<code>jax-ws-catalog.xml</code>	
<code>jndi.properties</code>	
<code>standardjbosscomp-jdbc.xml</code>	

### A.1.1.2. Contents of deployers directory

The files in the `deployers` directory are explained in the following table.

**Table A.4. Contents of deployers directory**

File	Description
<code>alias-deployers-jboss-beans.xml</code>	This file contains deployers that treat aliases in deployment as true controller context. Which means they will only get active/installed when their original is installed.
<code>bsh.deployer</code>	This file configures the bean shell deployer, which deploys bean shell scripts as JBoss mbean services.
<code>clustering-deployer-jboss-beans.xml</code>	Clustering-related deployers which add dependencies on needed clustering services to clustered EJB3, EJB2 beans and to distributable web applications.
<code>dependency-deployers-jboss-beans.xml</code>	Deployers for <code>aliases.txt</code> and <code>jboss-dependency.xml</code> . <code>jboss-dependency.xml</code> adds generic dependency and <code>aliases.txt</code> adds human-readable names for deployments. For instance, <code>vfszip://home/something/.../jboss-5.0.0.GA/server/default/deploy/some-long-name.ear</code> aliased to <code>ales-app.ear</code> .
<code>directory-deployer-jboss-beans.xml</code>	Adds legacy behavior for directories, handling its children as possible deployments. For example, <code>.sar's lib</code> directory to treat the <code>.jar</code> files as deployments.
<code>ear-deployer-jboss-beans.xml</code>	JavaEE 5 enterprise application related deployers.
<code>ejb-deployer-jboss-beans.xml</code>	Legacy JavaEE 1.4 ejb jar related deployers.

File	Description
<b>ejb3.deployer</b>	This is a deployer that supports JavaEE 5 ejb3, JPA, and application client deployments.
<b>hibernate-deployer-jboss-beans.xml</b>	Deployers for Hibernate -hibernate.xml descriptors, which are similar to Hibernate's <b>.cfg.xml</b> files.
<b>jboss-aop-jboss5.deployer</b>	JBossAspectLibrary and base aspects.
<b>jboss-ejb3-endpoint-deployer.jar</b>	
<b>jboss-ejb3-metrics-deployer.jar</b>	
<b>jboss-jca.deployer</b>	<b>jboss-jca.deployer</b> description
<b>jboss-threads.deployer</b>	
<b>jbossweb.deployer</b>	The JavaEE 5 servlet, JSF, JSP deployers.
<b>jbossws.deployer</b>	The JavaEE 5 web services endpoint deployers.
<b>jsr77-deployers-jboss-beans.xml</b>	Deployers for creating the JSR77 MBeans from the JavaEE components.
<b>logbridge-jboss-beans.xml</b>	
<b>messaging-definitions-jboss-beans.xml</b>	
<b>metadata-deployer-jboss-beans.xml</b>	Deployers for processing the JavaEE metadata from xml, annotations.
<b>seam.deployer</b>	Deployer providing integration support for JBoss Seam applications.
<b>security-deployer-jboss-beans.xml</b>	Deployers for configuration the security layers of the JavaEE components.
<b>xnio.deployer</b>	

### A.1.1.3. Contents of deploy directory

The files in the **deploy** directory are explained in the following table.

**Table A.5. Contents of "deploy" directory**

File	Description
<b>ROOT.war</b>	<b>ROOT.war</b> establishes the '/' root web application.
<b>admin-console.war</b>	This is the <b>admin-console</b> application which provides a web interface for JBoss Enterprise Application Platform administrators. By default the admin-console is available at <b>http://localhost:8080/admin-console</b> .
<b>cache-invalidation-service.xml</b>	This is a service that allows for custom invalidation of the EJB caches via JMS notifications. It is disabled by default.
<b>ejb2-container-jboss-beans.xml</b>	<b>ejb2-container-jboss-beans.xml</b> <b>UserTransaction</b> integration bean for the EJB2 containers.
<b>ejb2-timer-service.xml</b>	<b>ejb2-timer-service.xml</b> contains the ejb timer service beans.
<b>ejb3-connectors-jboss-beans.xml</b>	<b>ejb3-connectors-jboss-beans.xml</b> EJB3 remoting transport beans.
<b>ejb3-container-jboss-beans.xml</b>	<b>ejb3-container-jboss-beans.xml</b> <b>UserTransaction</b> integration bean for the EJB3 containers.
<b>ejb3-interceptors-aop.xml</b>	<b>ejb3-interceptors-aop.xml</b> defines the EJB3 container aspects.
<b>ejb3-timerservice-jboss-beans.xml</b>	<b>ejb3-timerservice-jboss-beans.xml</b> configures the EJB3 TimerService
<b>hdscanner-jboss-beans.xml</b>	<b>hdscanner-jboss-beans.xml</b> the deploy directory hot deployment scanning bean
<b>hsqldb-ds.xml</b>	Configures the Hypersonic embedded database service configuration file. It sets up the embedded database and related connection factories.
<b>http-invoker.sar</b>	Contains the detached invoker that supports RMI over HTTP. It also contains the proxy bindings for accessing JNDI over HTTP.
<b>jboss-local-jdbc.rar</b>	Is a JCA resource adaptor that implements the JCA <b>ManagedConnectionFactory</b> interface for JDBC drivers that support the <b>DataSource</b> interface but not JCA.



File	Description
<code>jboss-xa-jdbc.rar</code>	JCA resource adaptors for XA DataSources.
<code>jbossweb.sar</code>	An mbean service supporting <b>TomcatDeployer</b> with web application deployment service management.
<code>jbossws.sar</code>	Provides JEE web services support.
<code>jca-jboss-beans.xml</code>	The <code>jca-jboss-beans.xml</code> file is the application server implementation of the JCA specification. It provides the connection management facilities for integrating resource adaptors into the server.
<code>jms-ra.rar</code>	<code>jms-ra.rar</code> JBoss JMS Resource Adapter.
<code>jmx-console.war</code>	This is the <code>jmx-console</code> application which provides a simple web interface for managing the MBean server. By default, the <code>jmx-console</code> is available at <a href="http://localhost:8080/jmx-console">http://localhost:8080/jmx-console</a>
<code>jmx-invoker-service.xml</code>	<code>jmx-invoker-service.xml</code> is an MBean service archive that exposes a subset of the JMX <b>MBeanServer</b> interface methods as an RMI interface to enable remote access to the JMX core functionality.
<code>jsr-88-service.xml</code>	<code>jsr-88-service.xml</code> provides the JSR 88 remote deployment service.
<code>legacy-invokers-service.xml</code>	<code>legacy-invokers-service.xml</code> the legacy detached jmx invoker remoting services.
<code>management/console-mgr.sar</code>	Provides the Web Console. It is a web application/applet that provides a richer view of the JMX server management data than the JMX console. You may view the console using the URL <a href="http://localhost:8080/web-console/">http://localhost:8080/web-console/</a> .
<code>messaging/destinations-service.xml</code>	Configures the default Dead Letter queue and the Expiry queue.
<code>messaging/hsqldb-persistence-service.xml</code>	Provides JMS state management using Hypersonic.
<code>messaging/messaging-service.xml</code>	The <code>messaging-service.xml</code> file configures the core JBoss Messaging service.

File	Description
<b>mail-ra.rar</b>	<b>mail-ra.rar</b> is a resource adaptor that provides a JavaMail connector.
<b>mail-service.xml</b>	The <b>mail-service.xml</b> file is an MBean service descriptor that provides JavaMail sessions for use inside the server.
<b>profiles-service-jboss-beans.xml</b>	<b>profiles-service-jboss-beans.xml</b> configures the ProfileService, which is a generalization of the server configuration.
<b>properties-service.xml</b>	The <b>properties-service.xml</b> file is an MBean service descriptor that allows for customization of the JavaBeans <b>PropertyEditors</b> as well as the definition of system properties.
<b>quartz-ra.rar</b>	<b>quartz-ra.rar</b> is a resource adaptor for inflow of Quartz events
<b>remoting-jboss-beans.xml</b>	<b>remoting-jboss-beans.xml</b> contains the unified invokers based on JBoss Remoting.
<b>scheduler-service.xml</b>	The <b>scheduler-service.xml</b> and <b>schedule-manager-service.xml</b> files are MBean service descriptors that provide a scheduling type of service.
<b>security/security-jboss-beans.xml</b>	<b>security-jboss-beans.xml</b> security domain related beans.
<b>security/security-policies-jboss-beans.xml</b>	<b>security-policies-jboss-beans.xml</b> security authorization related beans for ejb and web authorization.
<b>schedule-manager-service.xml</b>	The <b>schedule-manager-service.xml</b> contains sample scheduler configurations. It is disabled by default.
<b>sqlexception-service.xml</b>	The <b>sqlexception-service.xml</b> file is an MBean service descriptor for the handling of vendor specific <b>SQLExceptions</b> .
<b>transaction-jboss-beans.xml</b>	<b>transaction-jboss-beans.xml</b> JTA transaction manager related beans.
<b>transaction-service.xml</b>	<b>transaction-service.xml</b> contains <b>ClientUserTransaction</b> proxy service configuration.

File	Description
<code>uuid-key-generator.sar</code>	The <code>uuid-key-generator.sar</code> service provides a UUID-based key generation facility.
<code>vfs-jboss-beans.xml</code>	The <code>vfs-jboss-beans.xml</code> configures the Microcontainer bean exposing the JBoss VFS cache statistics.
<code>xnio-provider.jar</code>	XNIO is a centralized management point for network services.

### A.1.2. The all Server Profile File Set

The `all` server profile is located in the `<JBOSS_HOME>/server/all` directory. In addition to the services in the "default" profile, the `all` configuration contains several other services in the `deploy/` directory as shown below.

**Table A.6. Additional Services in `deploy` directory for `all` profile**

File	Description
<code>cluster/deploy-hasingleton-service.xml</code>	This provides the HA singleton service, allowing JBoss to manage services that must be active on only one node of a cluster.
<code>cluster/farm-deployment-jboss-beans.xml</code>	This provides the farm service, which allows for cluster-wide deployment and undeployment of services.
<code>httpha-invoker.sar</code>	This service provides HTTP tunneling support for clustered environments.
<code>http-invoker.sar</code>	
<code>iiop-service.xml</code>	This provides IIOP invocation support.
<code>juddi-service.sar</code>	This service provides UDDI lookup services.
<code>snmp-adaptor.sar</code>	This is a JMX to SNMP adaptor. It allows for the mapping of JMX notifications onto SNMP traps.

### A.1.3. EJB3 Services

The following table explains the files providing `ejb3` services.

**Table A.7. EJB3 Services**

File	Description
<b>ejb3-interceptors-aop.xml</b>	This service provides the AOP interceptor stack configurations for EJB3 bean types.
<b>ejb3.deployer</b>	This service deploys EJB3 applications into JBoss.
<b>jbossws.sar</b>	This provides Java EE 5 web services support.

## APPENDIX B. VENDOR-SPECIFIC DATASOURCE DEFINITIONS

This appendix includes datasource definitions for databases supported by JBoss Enterprise Application Platform.

### B.1. DEPLOYER LOCATION AND NAMING

All database deployers should be saved to the `<JBOSS_HOME>/server/<PROFILE>/deploy/` directory on the server. Each deployer file needs to end with the suffix `-ds.xml`. For instance, an Oracle datasource deployer might be named `oracle-ds.xml`. If files are not named properly, they are not found by the server.

### B.2. DB2

#### Example B.1. DB2 Local-XA

Copy the `$db2_install_dir/java/db2jcc.jar` and `$db2_install_dir/java/db2jcc_license_cu.jar` files into the `$jboss_install_dir/server/default/lib` directory. The `db2java.zip` file, which is part of the legacy CLI driver, is normally not required when using the DB2 Universal JDBC driver included in DB2 v8.1 and later.

```
<datasources>

  <local-tx-datasource>
    <jndi-name>DB2DS</jndi-name>
    <!-- Use the syntax 'jdbc:db2:yourdatabase' for jdbc type 2
connection -->
    <!-- Use the syntax 'jdbc:db2://serveraddress:port/yourdatabase' for
jdbc type 4 connection -->
    <connection-
url>jdbc:db2://serveraddress:port/yourdatabase</connection-url>
    <driver-class>com.ibm.db2.jcc.DB2Driver</driver-class>
    <user-name>x</user-name>
    <password>y</password>
    <min-pool-size>0</min-pool-size>
    <!-- sql to call when connection is created
<new-connection-sql>some arbitrary sql</new-connection-sql>
    -->

    <!-- sql to call on an existing pooled connection when it is
obtained from pool
<check-valid-connection-sql>some arbitrary sql</check-valid-
connection-sql>
    -->

    <!-- corresponding type-mapping in the standardjbosscomp-jdbc.xml
(optional) -->
    <metadata>
      <type-mapping>DB2</type-mapping>
    </metadata>
  </local-tx-datasource>
</datasources>
```

**Example B.2. DB2 XA**

Copy the `$db2_install_dir/java/db2jcc.jar` and `$db2_install_dir/java/db2jcc_license_cu.jar` files into the `$jboss_install_dir/server/default/lib` directory.

The `db2java.zip` file is required when using the DB2 Universal JDBC driver (type 4) for XA on DB2 v8.1 fixpak 14 (and the corresponding DB2 v8.2 fixpak 7).

```
<datasources>
  <!--
    XADatasource for DB2 v8.x (app driver)
  -->

  <xa-datasource>
    <jndi-name>DB2XADS</jndi-name>

    <xa-datasource-class>com.ibm.db2.jcc.DB2XADataSource</xa-
datasource-class>
    <xa-datasource-property name="ServerName">your_server_address</xa-
datasource-property>
    <xa-datasource-property name="PortNumber">your_server_port</xa-
datasource-property>
    <xa-datasource-property name="DatabaseName">your_database_name</xa-
datasource-property>
    <!-- DriverType can be either 2 or 4, but you most likely want to
use the JDBC type 4 as it does not require a DB" client -->
    <xa-datasource-property name="DriverType">4</xa-datasource-
property>
    <!-- If driverType 4 is used, the following two tags are needed -->
    <track-connection-by-tx></track-connection-by-tx>
    <isSameRM-override-value>>false</isSameRM-override-value>

    <xa-datasource-property name="User">your_user</xa-datasource-
property>
    <xa-datasource-property name="Password">your_password</xa-
datasource-property>

    <!-- corresponding type-mapping in the standardjbosscomp-jdbc.xml
(optional) -->
    <metadata>
      <type-mapping>DB2</type-mapping>
    </metadata>
  </xa-datasource>
</datasources>
```

**Example B.3. DB2 on AS/400**

```
<?xml version="1.0" encoding="UTF-8"?>
```

```

<!--
===== --
>
<!--
-->
<!--  JBoss Server Configuration
-->
<!--
-->
<!--
===== --
>

<!-- $Id: db2-400-ds.xml,v 1.1.4.2 2004/10/27 18:44:10 pilhuhn Exp $ -->

<!-- You need the jt400.jar that is delivered with IBM iSeries Access or
the
OpenSource Project jtopen.

[systemname] Hostame of the iSeries
[schema]      Default schema is needed so jboss could use metadat to
test if the tables exists
-->

<datasources>
  <local-tx-datasource>
    <jndi-name>DB2-400</jndi-name>
    <connection-url>jdbc:as400://[systemname]/[schema];extended
dynamic=true;package=jbpkg;package cache=true;package
library=jboss;errors=full</connection-url>
    <driver-class>com.ibm.as400.access.AS400JDBCdriver</driver-class>
    <user-name>[username]</user-name>
    <password>[password]</password>
    <min-pool-size>0</min-pool-size>
    <!-- sql to call when connection is created
    <new-connection-sql>some arbitrary sql</new-connection-sql>
    -->

    <!-- sql to call on an existing pooled connection when it is
obtained from pool
    <check-valid-connection-sql>some arbitrary sql</check-valid-
connection-sql>
    -->
    <!-- corresponding type-mapping in the standardjbosscomp-jdbc.xml
(optional) -->
    <metadata>
      <type-mapping>DB2/400</type-mapping>
    </metadata>

  </local-tx-datasource>
</datasources>

```

The *Native* JDBC driver is shipped as part of the IBM Developer Kit for Java (57xxJV1). It is implemented by making native method calls to the SQL *CLI* (*Call Level Interface*), and it only runs on the i5/OS JVM. The class name to register is `com.ibm.db2.jdbc.app.DB2Driver`. The URL subprotocol is `db2`. Refer to the JDBC FAQs at <http://www-03.ibm.com/systems/i/software/toolbox/faqjdbc.html#faqA1> for more information.

```
<?xml version="1.0" encoding="UTF-8"?>
<!--
===== --
>
<!--
-->
<!-- JBoss Server Configuration
-->
<!--
-->
<!--
===== --
>
<!-- $Id: db2-400-ds.xml,v 1.1.4.2 2004/10/27 18:44:10 pilhuhn Exp $
-->
<!-- You need the jt400.jar that is delivered with IBM iSeries Access or
the
OpenSource Project jtopen.
[systemname] Hostame of the iSeries
[schema] Default schema is needed so jboss could use metadat to
test if the tables exists -->
<datasources>
  <local-tx-datasource>
    <jndi-name>DB2-400</jndi-name>
    <connection-url>jdbc:db2://[systemname]/[schema];extended
dynamic=true;package=jbpkg;package cache=true;package
library=jboss;errors=full</connection-url>
    <driver-class>com.ibm.db2.jdbc.app.DB2Driver</driver-class>
    <user-name>[username]</user-name>
    <password>[password]</password>
    <min-pool-size>0</min-pool-size>
    <!-- sql to call when connection is created
    <new-connection-sql>some arbitrary sql</new-connection-sql> --
  >

    <!-- sql to call on an existing pooled connection when it is
obtained from pool
    <check-valid-connection-sql>some arbitrary sql</check-valid-
connection-sql> -->
    <!-- corresponding type-mapping in the standardjbosscomp-jdbc.xml
(optional) -->
    <metadata>
      <type-mapping>DB2/400</type-mapping>
    </metadata>
  </local-tx-datasource>
</datasources>
```

#### Tips

- This driver is sensitive to the job's CCSID, but works fine with **CCSID=37**.



- [systemname] must be defined as entry WRKRDBDIRE like \*local.

## B.3. ORACLE

### Example B.5. Oracle Local-TX Datasource

```
<?xml version="1.0" encoding="UTF-8"?>

<!--
===== --
>
<!--
-->
<!--  JBoss Server Configuration
-->
<!--
-->
<!--
===== --
>

<!-- $Id: oracle-ds.xml,v 1.6 2004/09/15 14:37:40 loubyansky Exp $ -->
<!--
===== -->
<!--  Datasource config for Oracle originally from Steven Coy
-->
<!--
===== -->

<datasources>
  <local-tx-datasource>
    <jndi-name>OracleDS</jndi-name>
    <connection-
url>jdbc:oracle:thin:@youroraclehost:1521:yoursid</connection-url>
    <!--
      See on WIKI page below how to use Oracle's thin JDBC driver to connect
      with enterprise RAC.
    -->
    <!--
      Here are a couple of the possible OCI configurations.
      For more information, see
      http://otn.oracle.com/docs/products/oracle9i/doc_library/release2/java.9
      20/a96654/toc.htm

    <connection-url>jdbc:oracle:oci:@youroracle-tns-name</connection-url>
    or
    <connection-url>jdbc:oracle:oci:@(description=(address=
      (host=youroraclehost)(protocol=tcp)(port=1521))(connect_data=
      (SERVICE_NAME=yourservicename)))</connection-url>

    Clearly, its better to have TNS set up properly.
    -->
    <driver-class>oracle.jdbc.driver.OracleDriver</driver-class>
```

```

<user-name>x</user-name>
<password>y</password>

<min-pool-size>5</min-pool-size>
<max-pool-size>100</max-pool-size>

  <!-- Uses the pingDatabase method to check a connection is still
  valid before handing it out from the pool -->
  <!--valid-connection-checker-class-
  name>org.jboss.resource.adapter.jdbc.vendor.OracleValidConnectionChecker
  </valid-connection-checker-class-name-->
  <!-- Checks the Oracle error codes and messages for fatal errors -->
  <exception-sorter-class-
  name>org.jboss.resource.adapter.jdbc.vendor.OracleExceptionSorter</excep
  tion-sorter-class-name>
  <!-- sql to call when connection is created
  <new-connection-sql>some arbitrary sql</new-connection-sql>
  -->

  <!-- sql to call on an existing pooled connection when it is
  obtained from pool - the OracleValidConnectionChecker is preferred
  <check-valid-connection-sql>some arbitrary sql</check-valid-
  connection-sql>
  -->

  <!-- corresponding type-mapping in the standardjbosscomp-jdbc.xml
  (optional) -->
  <metadata>
    <type-mapping>Oracle9i</type-mapping>
  </metadata>
</local-tx-datasource>

</datasources>

```

### Example B.6. Oracle XA Datasource

```

<?xml version="1.0" encoding="UTF-8"?>

<!--
===== --
>
<!--
-->
<!-- JBoss Server Configuration
-->
<!--
-->
<!--
===== --
>

<!-- $Id: oracle-xa-ds.xml,v 1.13 2004/09/15 14:37:40 loubiansky Exp $ -
-->

```

```

<!--
===== --
>
<!-- ATTENTION: DO NOT FORGET TO SET Pad=true IN transaction-
service.xml -->
<!--
===== --
>

<datasources>
  <xa-datasource>
    <jndi-name>XAOracleDS</jndi-name>
    <track-connection-by-tx></track-connection-by-tx>
    <isSameRM-override-value>>false</isSameRM-override-value>
    <xa-datasource-class>oracle.jdbc.xa.client.OracleXADataSource</xa-
datasource-class>
    <xa-datasource-property name="URL">jdbc:oracle:oci8:@tc</xa-
datasource-property>
    <xa-datasource-property name="User">scott</xa-datasource-property>
    <xa-datasource-property name="Password">tiger</xa-datasource-
property>
    <!-- Uses the pingDatabase method to check a connection is still
valid before handing it out from the pool -->
    <!--valid-connection-checker-class-
name>org.jboss.resource.adapter.jdbc.vendor.OracleValidConnectionChecker
</valid-connection-checker-class-name-->
    <!-- Checks the Oracle error codes and messages for fatal errors -->
    <exception-sorter-class-
name>org.jboss.resource.adapter.jdbc.vendor.OracleExceptionSorter</excep
tion-sorter-class-name>
    <!-- Oracles XA datasource cannot reuse a connection outside a
transaction once enlisted in a global transaction and vice-versa -->
    <no-tx-separate-pools></no-tx-separate-pools>

    <!-- corresponding type-mapping in the standardjbosscomp-jdbc.xml
(optional) -->
    <metadata>
      <type-mapping>Oracle9i</type-mapping>
    </metadata>
  </xa-datasource>

  <mbean
code="org.jboss.resource.adapter.jdbc.vendor.OracleXAExceptionFormatter"
  name="jboss:jca:service=OracleXAExceptionFormatter">
    <depends optional-attribute-
name="TransactionManagerService">jboss:service=TransactionManager</depen
ds>
  </mbean>

</datasources>

```

**Example B.7. Oracle's Thin JDBC Driver with Enterprise RAC**

The extra configuration to use Oracle's Thin JDBC driver to connect with Enterprise RAC involves the <connection-url>. The two hostnames provide load balancing and failover to the underlying physical database.

```

...
<connection-url>jdbc:oracle:thin:@(description=(address_list=
(load_balance=on)(failover=on)(address=(protocol=tcp)(host=xxxxhost1)
(port=1521))(address=(protocol=tcp)(host=xxxxhost2)(port=1521)))
(connect_data=(service_name=xxxxsid)(failover_mode=(type=select)
(method=basic))))</connection-url>
...

```



#### NOTE

This example has only been tested against Oracle 10g.

### B.3.1. Changes in Oracle 10g JDBC Driver

It is no longer necessary to enable the `Pad` option in your `jboss-service.xml` file. Further, you no longer need the `<no-tx-separate-pool/>`.

### B.3.2. Type Mapping for Oracle 10g

You need to specify Oracle9i type mapping for Oracle 10g datasource configurations.

#### Example B.8. Oracle9i Type Mapping

```

.....
<metadata>
  <type-mapping>Oracle9i</type-mapping>
</metadata>
.....

```

### B.3.3. Retrieving the Underlying Oracle Connection Object

#### Example B.9. Oracle Connection Object

```

Connection conn = myJBossDatasource.getConnection();
WrappedConnection wrappedConn = (WrappedConnection)conn;
Connection underlyingConn = wrappedConn.getUnderlyingConnection();
OracleConnection oracleConn = (OracleConnection)underlyingConn;

```

### B.3.4. Limitations of Oracle 11g

In Oracle 11g R2 (both RAC and standalone), a complex query with `LockMode.UPGRADE` (ie: "for update") may cause a "No more data to read from socket" error. The workaround is to not use `LockMode.UPGRADE` on such queries. See Oracle bug number 9219636 for more details.

## B.4. SYBASE

### Example B.10. Sybase Datasource

```
<?xml version="1.0" encoding="UTF-8"?>

<datasources>
  <local-tx-datasource>
    <jndi-name>jdbc/SybaseDB</jndi-name>
    <!-- Sybase jConnect URL for the database.
NOTE: The hostname and port are made up values. The optional
database name is provided, as well as some additinal Driver
parameters.
-->
    <connection-url>jdbc:sybase:Tds:host.at.some.domain:5000/db_name?
JCONNECT_VERSION=6</connection-url>
    <driver-class>com.sybase.jdbc2.jdbc.SybDataSource</driver-class>
    <user-name>x</user-name>
    <password>y</password>
    <exception-sorter-class-
name>org.jboss.resource.adapter.jdbc.vendor.SybaseExceptionSorter</excep
tion-sorter-class-name>
    <!-- sql to call when connection is created
<new-connection-sql>some arbitrary sql</new-connection-sql>
-->

    <!-- sql to call on an existing pooled connection when it is
obtained from pool
<check-valid-connection-sql>some arbitrary sql</check-valid-
connection-sql>
-->

    <!-- corresponding type-mapping in the standardjbosscomp-jdbc.xml
(optional) -->
    <metadata>
      <type-mapping>Sybase</type-mapping>
    </metadata>
  </local-tx-datasource>
</datasources>
```

[1]

### B.4.1. Sybase Limitations

Sybase has some configuration anomalies, which you should be aware of.

#### DDL statements in transactions

Hibernate, which is an integral part of the Enterprise Platform, allows the SQL Dialect to decide whether or not the database supports DDL statements within a transaction. Sybase does not override this. the default is to query the JDBC metadata to see whether DDL is allowed within transactions. However, Sybase does not correct report whether it is set up to use this option.

Sybase recommends against using DDL statements in transactions, because of locking issues. Review the Sybase documentation for how to enable or disable the `ddl in tran` option.

### Sybase does not throw an exception if a value overflows the constraints of the underlying column.

Sybase ASE does not throw an exception when Parameterized Sql is in use. `jconn3.jar` uses Parameterized Sql for insertion by default, so no exception is thrown if a value overflows the constraints of the underlying column. Since no exception is thrown, Hibernate cannot tell that the insert failed. By using Dynamic Prepare instead of Parameterized SQL, ASE throws an exception. Hibernate can catch this exception and act accordingly.

For that reason, set the `Dynamic prepare` parameter to `true` in Hibernate's configuration file.

```
<property name="connection.url">jdbc:sybase:Tds:aurum:1503/masterDb?
DYNAMIC_PREPARE=true</property>
```

`jconn4.jar` uses Dynamic Prepare by default.

### SchemaExport cannot create stored procedures in chained transaction mode

On Sybase, SchemaExport cannot be used to create stored procedures while in while in chained transaction mode. The workaround for this case is to add the following code immediately after the definition of the new stored procedure:

```
<database-object>
  <create>
    sp_procxmode paramHandling, 'chained'
  </create>
  <drop/>
</database-object>
```

## B.5. MICROSOFT SQL SERVER

To evaluate those drivers, you can use a simple JSP page to query the `pubs` database shipped with Microsoft SQL Server.

Move the WAR archive located in [files/mssql-test.zip](#) to the `/deploy`, start the server, and navigate your web browser to <http://localhost:8080/test/test.jsp>.

### Example B.11. Local-TX Datasource Using DataDirect Driver

This example uses the DataDirect Connect for JDBC drivers from <http://www.datadirect.com>.

```
<datasources>
  <local-tx-datasource>
    <jndi-name>MerliaDS</jndi-name>
    <connection-
url>jdbc:datadirect:sqlserver://localhost:1433;DatabaseName=jboss</conne
ction-url>
    <driver-class>com.ddtek.jdbc.sqlserver.SQLServerDriver</driver-
class>
    <user-name>sa</user-name>
    <password>sa</password>
```

```

    <!-- corresponding type-mapping in the standardjbosscomp-jdbc.xml
(optional) -->
    <metadata>
      <type-mapping>MS SQLSERVER2000</type-mapping>
    </metadata>
  </local-tx-datasource>
</datasources>

```

### Example B.12. Local-TX Datasource Using Merlia Driver

This example uses the Merlia JDBC Driver drivers from <http://www.inetsoftware.de>.

```

<datasources>
  <local-tx-datasource>
    <jndi-name>MerliaDS</jndi-name>
    <connection-url>jdbc:inetdae7:localhost:1433?
database=pubs</connection-url>
    <driver-class>com.inet.tds.TdsDataSource</driver-class>
    <user-name>sa</user-name>
    <password>sa</password>

    <!-- corresponding type-mapping in the standardjbosscomp-jdbc.xml
(optional) -->
    <metadata>
      <type-mapping>MS SQLSERVER2000</type-mapping>
    </metadata>
  </local-tx-datasource>
</datasources>

```

### Example B.13. XA Datasource Using Merlia Driver

This example uses the Merlia JDBC Driver drivers from <http://www.inetsoftware.de>.

```

<datasources>
  <xa-datasource>
    <jndi-name>MerliaXADS</jndi-name>
    <track-connection-by-tx></track-connection-by-tx>
    <isSameRM-override-value>>false</isSameRM-override-value>
    <xa-datasource-class>com.inet.tds.DTCDataSource</xa-datasource-
class>
    <xa-datasource-property name="ServerName">localhost</xa-datasource-
property>
    <xa-datasource-property name="DatabaseName">pubs</xa-datasource-
property>
    <user-name>sa</user-name>
    <password>sa</password>

    <!-- corresponding type-mapping in the standardjbosscomp-jdbc.xml
(optional) -->
    <metadata>

```

```

        <type-mapping>MS SQLSERVER2000</type-mapping>
    </metadata>
</xa-datasource>

</datasources>

```

### B.5.1. Microsoft JDBC Drivers

Microsoft SQL Server 2008 JDBC Driver can be used with SQL Server 2008 or 2008 R2 and is certified for JBoss Hibernate.

Read the `release.txt` file included in the driver distribution for more information.

#### Example B.14. Microsoft SQL Server 2008 Local-TX Datasource

```

<?xml version="1.0" encoding="UTF-8"?>

<datasources>
  <local-tx-datasource>
    <jndi-name>MSSQL2008DS</jndi-name>
    <connection-
url>jdbc:sqlserver://localhost:1433;DatabaseName=pubs</connection-url>
    <driver-class>com.microsoft.sqlserver.jdbc.SQLServerDriver</driver-
class>
    <user-name>sa</user-name>
    <password>jboss</password>

    <!-- corresponding type-mapping in the standardjbosscomp-jdbc.xml
(optional) -->
    <metadata>
      <type-mapping>MS SQLSERVER2000</type-mapping>
    </metadata>
  </local-tx-datasource>
</datasources>

```

#### Example B.15. Microsoft SQL Server 2008 XA Datasource

```

<?xml version="1.0" encoding="UTF-8"?>

<datasources>
  <xa-datasource>
    <jndi-name>MSSQL2008XADS</jndi-name>
    <track-connection-by-tx></track-connection-by-tx>
    <isSameRM-override-value>>false</isSameRM-override-value>
  <xa-datasource-
class>com.microsoft.sqlserver.jdbc.SQLServerXADataSource</xa-datasource-
class>
    <xa-datasource-property name="ServerName">localhost</xa-datasource-
property>
    <xa-datasource-property name="DatabaseName">pubs</xa-datasource-

```



```

property>
  <xa-datasource-property name="SelectMethod">cursor</xa-datasource-
property>
  <xa-datasource-property name="User">sa</xa-datasource-property>
  <xa-datasource-property name="Password">jboss</xa-datasource-
property>

  <!-- corresponding type-mapping in the standardjbosscomp-jdbc.xml
(optional) -->
  <metadata>
    <type-mapping>MS SQLSERVER2000</type-mapping>
  </metadata>
</xa-datasource>

</datasources>

```

## B.5.2. JSQL Drivers

### Example B.16. JSQL Driver

```

<?xml version="1.0" encoding="UTF-8"?>

<datasources>
  <local-tx-datasource>
    <jndi-name>JSQLDS</jndi-name>
    <connection-
url>jdbc:JSQLConnect://localhost:1433/databaseName=testdb</connection-
url>
    <driver-class>com.jnetdirect.jsql.JSQLDriver</driver-class>
    <user-name>x</user-name>
    <password>y</password>
    <!-- sql to call when connection is created
-->
    <new-connection-sql>some arbitrary sql</new-connection-sql>

    <!-- sql to call on an existing pooled connection when it is
obtained from pool
-->
    <check-valid-connection-sql>some arbitrary sql</check-valid-
connection-sql>
    <!--

  </local-tx-datasource>

</datasources>

```

## B.5.3. jTDS JDBC Driver

jTDS is an open source 100% pure Java (type 4) JDBC 3.0 driver for Microsoft SQL Server (6.5, 7, 2000 and 2005) and Sybase (10, 11, 12, 15). jTDS is based on FreeTDS and is currently the fastest production-ready JDBC driver for microsoft SQL Server and Sybase. jTDS is 100% JDBC 3.0

compatible, supporting forward-only and scrollable/updatable ResultSets, concurrent (completely independent) Statements and implementing all the `DatabaseMetaData` and `ResultSetMetaData` methods.

Download jTDS from <http://jtds.sourceforge.net/>.

#### Example B.17. jTDS Local-TX Datasource

```
<?xml version="1.0" encoding="UTF-8"?>

<datasources>
  <local-tx-datasource>
    <jndi-name>jtdsDS</jndi-name>
    <connection-
url>jdbc:jtds:sqlserver://localhost:1433;databaseName=pubs</connection-
url>
    <driver-class>net.sourceforge.jtds.jdbc.Driver</driver-class>
    <user-name>sa</user-name>
    <password>jboss</password>

    <!-- optional parameters -->
    <transaction-isolation>TRANSACTION_READ_COMMITTED</transaction-
isolation>
    <min-pool-size>10</min-pool-size>
    <max-pool-size>30</max-pool-size>
    <idle-timeout-minutes>15</idle-timeout-minutes>
    <blocking-timeout-millis>5000</blocking-timeout-millis>
    <new-connection-sql>select 1</new-connection-sql>
    <check-valid-connection-sql>select 1</check-valid-connection-sql>
    <set-tx-query-timeout></set-tx-query-timeout>
    <metadata>
      <type-mapping>MS SQLSERVER2000</type-mapping>
    </metadata>
  </local-tx-datasource>
</datasources>
```

#### Example B.18. jTDS XA Datasource

```
<?xml version="1.0" encoding="UTF-8"?>

<datasources>
  <xa-datasource>
    <jndi-name>jtdsXADS</jndi-name>
    <xa-datasource-class>net.sourceforge.jtds.jdbcx.JtdsDataSource</xa-
datasource-class>
    <xa-datasource-property name="ServerName">localhost</xa-datasource-
property>
    <xa-datasource-property name="DatabaseName">pubs</xa-datasource-
property>
    <xa-datasource-property name="User">sa</xa-datasource-property>
    <xa-datasource-property name="Password">jboss</xa-datasource-
property>
```

```

    <!--
    When set to true, emulate XA distributed transaction support. Set to
    false to use experimental
    true distributed transaction support. True distributed transaction
    support is only available for
    SQL Server 2000 and requires the installation of an external stored
    procedure in the target server
    (see the README.XA file in the distribution for details).
    -->
    <xa-datasource-property name="XaEmulation">true</xa-datasource-
    property>

    <track-connection-by-tx></track-connection-by-tx>

    <!-- optional parameters -->
    <transaction-isolation>TRANSACTION_READ_COMMITTED</transaction-
    isolation>
    <min-pool-size>10</min-pool-size>
    <max-pool-size>30</max-pool-size>
    <idle-timeout-minutes>15</idle-timeout-minutes>
    <blocking-timeout-millis>5000</blocking-timeout-millis>
    <new-connection-sql>select 1</new-connection-sql>
    <check-valid-connection-sql>select 1</check-valid-connection-sql>
    <set-tx-query-timeout></set-tx-query-timeout>
    <metadata>
        <type-mapping>MS SQLSERVER2000</type-mapping>
    </metadata>
</xa-datasource>

</datasources>

```

#### B.5.4. "Invalid object name 'JMS\_SUBSCRIPTIONS' Exception

If you receive an exception like the one in [Example B.19](#), “JMS\_SUBSCRIPTIONS Exception” during start up, specify a `SelectMethod` in the connection URL, as shown in [Example B.20](#), “Specifying a `SelectMethod`”.

##### Example B.19. JMS\_SUBSCRIPTIONS Exception

```

17:17:57,167 WARN [ServiceController] Problem starting
service jboss.mq.destination:name=testTopic,service=Topic
org.jboss.mq.SpyJMSEException: Error getting durable
subscriptions for topic TOPIC.testTopic; - nested throwable:
(java.sql.SQLException: [Microsoft][SQLServer 2000 Driver for JDBC]
[SQLServer]Invalid object name 'JMS_SUBSCRIPTIONS'.)
at
org.jboss.mq.sm.jdbc.JDBCStateManager.getDurableSubscriptionIdsForTopic(
JDBCStateManager.java:290)
at
org.jboss.mq.server.JMSDestinationManager.addDestination(JMSDestinationM
anager.java:656)

```

**Example B.20. Specifying a SelectMethod**

```
<connection-
url>jdbc:microsoft:sqlserver://localhost:1433;SelectMethod=cursor;DatabaseName=jboss</connection-url>
```

**B.6. MYSQL DATASOURCE****B.6.1. Installing the Driver****Procedure B.1. Installing the Driver**

1. Download the driver from <http://www.mysql.com/products/connector/j/>. Make sure to choose the driver based on your version of MySQL.
2. Expand the driver ZIP or TAR file, and locate the `.jar` file.
3. Move the `.jar` file into `<JBOSS_HOME>/server/<PROFILE>/lib`.
4. Copy the `<JBOSS_HOME>docs/examples/jca/mysql-ds.xml` example datasource deployer file to `<JBOSS_HOME>/server/<PROFILE>/deploy/`, for use as a template.

**MySQL limitations****Millisecond and microsecond measurements**

MySQL does not currently support millisecond and microsecond measurements when returning database values such as `TIME` and `TIMESTAMP`. Tests which rely on these measurements will fail.

**B.6.2. MySQL Local-TX Datasource****Example B.21. MySQL Local-TX Datasource**

This example uses a database hosted on `localhost`, on port `3306`, with `autoReconnect` enabled. This is not a recommended configuration, unless you do not need any Transactions support.

```
<datasources>
  <local-tx-datasource>

    <jndi-name>MySQLDS</jndi-name>

    <connection-url>jdbc:mysql://localhost:3306/database</connection-
url>
    <driver-class>com.mysql.jdbc.Driver</driver-class>

    <user-name>username</user-name>
    <password>secret</password>

    <connection-property name="autoReconnect">true</connection-
property>
```

```

    <!-- Typemapping for JBoss 4.0 -->
    <metadata>
      <type-mapping>mySQL</type-mapping>
    </metadata>

  </local-tx-datasource>
</datasources>

```

### B.6.3. MySQL Using a Named Pipe

#### Example B.22. MySQL Using a Named Pipe

This example uses a database hosted locally, but uses a named pipe instead of TCP/IP.

```

<datasources>
  <local-tx-datasource>

    <jndi-name>MySQLDS</jndi-name>
    <connection-url>jdbc:mysql://./database</connection-url>
    <driver-class>com.mysql.jdbc.Driver</driver-class>

    <user-name>username</user-name>
    <password>secret</password>

    <connection-property
name="socketFactory">com.mysql.jdbc.NamedPipeSocketFactory</connection-
property>

    <metadata>
      <type-mapping>mySQL</type-mapping>
    </metadata>

  </local-tx-datasource>
</datasources>

```

## B.7. POSTGRESQL

#### Example B.23. PostgreSQL Local-TX Datasource

```

<?xml version="1.0" encoding="UTF-8"?>

<datasources>
  <local-tx-datasource>
    <jndi-name>PostgresDS</jndi-name>
    <connection-url>jdbc:postgresql://[servername]:[port]/[database
name]</connection-url>
    <driver-class>org.postgresql.Driver</driver-class>
    <user-name>x</user-name>
    <password>y</password>
    <!-- sql to call when connection is created
<new-connection-sql>some arbitrary sql</new-connection-sql>

```

```

-->

<!-- sql to call on an existing pooled connection when it is
obtained from pool
<check-valid-connection-sql>some arbitrary sql</check-valid-
connection-sql>
-->

<!-- corresponding type-mapping in the standardjbosscomp-jdbc.xml
(optional) -->
<metadata>
  <type-mapping>PostgreSQL 8.0</type-mapping>
</metadata>
</local-tx-datasource>

</datasources>

```

## IMPORTANT

XA Transactions are denied if *max\_prepared\_transactions* uses the default value (0) in PostgreSQL v8.4 and v8.2.

PostgreSQL user documentation recommends you set the *max\_prepared\_transactions* value to meet or exceed the value of *max\_connections* so every session can have a prepared transaction pending.

For more information, refer to the PostgreSQL v8.4 User Documentation, located at <http://www.postgresql.org/docs/8.4/interactive/runtime-config-resource.html#GUC-MAX-PREPARED-TRANSACTIONS>

### Example B.24. PostgreSQL XA Datasource

This configuration works for PostgreSQL 8.x and later.

```

<?xml version="1.0" encoding="UTF-8"?>

<datasources>
  <xa-datasource>
    <jndi-name>PostgresDS</jndi-name>

    <xa-datasource-class>org.postgresql.xa.PGXADatasource</xa-
datasource-class>
    <xa-datasource-property name="ServerName">[servername]</xa-
datasource-property>
    <xa-datasource-property name="PortNumber">5432</xa-datasource-
property>

    <xa-datasource-property name="DatabaseName">[database name]</xa-
datasource-property>
    <xa-datasource-property name="User">[username]</xa-datasource-
property>
    <xa-datasource-property name="Password">[password]</xa-datasource-
property>

```

```

    <track-connection-by-tx></track-connection-by-tx>
  </xa-datasource>
</datasources>

```

## B.8. INGRES

### Example B.25. Ingres Datasource

```

<?xml version="1.0" encoding="UTF-8"?>

<datasources>
  <local-tx-datasource>
    <jndi-name>IngresDS</jndi-name>
    <use-java-context>false</use-java-context>
    <driver-class>com.ingres.jdbc.IngresDriver</driver-class>
    <connection-url>jdbc:ingres://localhost:II7/testdb</connection-url>
    <datasource-class>com.ingres.jdbc.IngresDataSource</datasource-
class>
    <datasource-property name="ServerName">localhost</datasource-
property>
    <datasource-property name="PortName">II7</datasource-property>
    <datasource-property name="DatabaseName">testdb</datasource-
property>
    <datasource-property name="User">testuser</datasource-property>
    <datasource-property name="Password">testpassword</datasource-
property>
    <new-connection-sql>select count(*) from iitables</new-connection-
sql>

    <check-valid-connection-sql>select count(*) from iitables</check-
valid-connection-sql>
    <metadata>
      <type-mapping>Ingres</type-mapping>
    </metadata>
  </local-tx-datasource>
</datasources>

```

[2]

[1] Source: <http://community.jboss.org/wiki/SetUpASybaseDatasource>

[2] Source: <http://community.ingres.com>

## APPENDIX C. LOGGING INFORMATION AND RECIPES

### C.1. LOG LEVEL DESCRIPTIONS

Table C.1, “[log4j Log Level Definitions](#)” lists the typical meanings for different log levels in `log4j`. Your application may interpret these levels differently, depending on your choices.

Table C.1. `log4j` Log Level Definitions

log4j Level	JDK Level	Description
FATAL		The Application Service is likely to crash.
ERROR	SEVERE	A definite problem exists.
WARN	WARNING	Likely to be a problem, but may be recoverable.
INFO	INFO	Low-volume detailed logging. Something of interest, but not a problem.
DEBUG	FINE	Low-volume detailed logging. Information that is probably not of interest.
	FINER	Medium-volume detailed logging.
TRACE	FINEST	High-volume detailed logging.



#### NOTE

The more verbose logging levels are not appropriate for production systems, because of the high level of output they generate.

#### Example C.1. Restricting Logged Information to a Specific Log Level

```

        <!-- Show the evolution of the DataSource pool in the logs
[inUse/Available/Max]-->
<category
name="org.jboss.resource.connectionmanager.JBossManagedConnectionPool">
  <priority value="TRACE" class="org.jboss.logging.XLevel"></priority>
</category>

```



## C.2. SEPARATE LOG FILES PER APPLICATION

To segregate logging output per application, assign **log4j** categories to specific appenders. This is typically done in the `conf/log4j.xml` deployment descriptor.

### Example C.2. Filtering App1 Log Output to a Separate File

```

        <appender name="App1Log" class="org.apache.log4j.FileAppender">
          <errorHandler
            class="org.jboss.logging.util.OnlyOnceErrorHandler"></errorHandler>
          <param name="Append" value="false"/>
          <param name="File" value="${jboss.server.home.dir}/log/app1.log"/>
          <layout class="org.apache.log4j.PatternLayout">
            <param name="ConversionPattern" value="%d{ABSOLUTE} %-5p [%c{1}]
%m%n"/>
          </layout>
        </appender>

...

<category name="com.app1">
  <appender-ref ref="App1Log"></appender-ref>
</category>
<category name="com.util">
  <appender-ref ref="App1Log"></appender-ref>
</category>

```

### Example C.3. Using TCLMCFilter

Enterprise Platform 5.1 includes the new class `org.jboss.logging.filter.TCLMCFilter`, which allows you to filter based on the deployment URL.

```

        <appender name="App1Log" class="org.apache.log4j.FileAppender">
          <errorHandler
            class="org.jboss.logging.util.OnlyOnceErrorHandler"></errorHandler>
          <param name="Append" value="false"/>
          <param name="File" value="${jboss.server.home.dir}/log/app1.log"/>
          <layout class="org.apache.log4j.PatternLayout">
            <param name="ConversionPattern" value="%d{ABSOLUTE} %-5p [%c{1}]
%m%n"/>
          </layout>
          <filter class="org.jboss.logging.filter.TCLMCFilter">
            <param name="AcceptOnMatch" value="true"/>
            <param name="DeployURL" value="app1.ear"/>
          </filter>

        <!-- end the filter chain here -->
        <filter class="org.apache.log4j.varia.DenyAllFilter"></filter>

```

```
</appender>
```

### C.3. REDIRECTING CATEGORY OUTPUT

When you increase the level of logging for one or more categories, it is often useful to redirect the output to a separate file for easier investigation. To do this you add an **appender-ref** to the category.

#### Example C.4. Adding an appender-ref

```
        <appender name="JSR77" class="org.apache.log4j.FileAppender">
        <param name="File" value="${jboss.server.home.dir}/log/jsr77.log"/>
        ...
    </appender>

    <!-- Limit the JSR77 categories -->
    <category name="org.jboss.management" additivity="false">
        <priority value="DEBUG"></priority>
        <appender-ref ref="JSR77"></appender-ref>
    </category>
```

All `org.jboss.management` output goes to the `jsr77.log` file. The `additivity` attribute controls whether output continues to go to the root category appender. If `false`, output only goes to the appenders referred to by the category.

---

## APPENDIX D. REVISION HISTORY

<b>Revision 5.2.0-100.400</b> Rebuild with publican 4.0.0	<b>2013-10-30</b>	<b>Rüdiger Landmann</b>
<b>Revision 5.2.0-100</b> Incorporated changes for JBoss Enterprise Application Platform 5.2.0 GA. For information about documentation changes to this guide, refer to <i>Release Notes 5.2.0</i> .	<b>Wed 23 Jan 2013</b>	<b>Russell Dickenson</b>
<b>Revision 5.1.2-103</b> Removed and commented unwanted in-line comments.	<b>Wed May 9 2012</b>	<b>Russell Dickenson</b>
<b>Revision 5.1.2-102</b> Replaced instances of 'JBoss AS' with 'JBoss Enterprise Application Server'	<b>Wed May 9 2012</b>	<b>Russell Dickenson</b>
<b>Revision 5.1.2-101</b> Bugfix for Bugzilla: <a href="https://bugzilla.redhat.com/show_bug.cgi?id=790543">https://bugzilla.redhat.com/show_bug.cgi?id=790543</a>	<b>Wed May 9 2012</b>	<b>Russell Dickenson</b>
<b>Revision 5.1.2-100</b> Incorporated changes for JBoss Enterprise Application Platform 5.1.2 GA. For information about documentation changes to this guide, refer to <i>Release Notes 5.1.2</i>	<b>Thu Dec 8 2011</b>	<b>Jared Morgan</b>
<b>Revision 5.1.1-100</b> Incorporated changes for JBoss Enterprise Application Platform 5.1.1 GA. For information about documentation changes to this guide, refer to <i>Release Notes 5.1.1</i>	<b>Mon Jul 18 2011</b>	<b>Jared Morgan</b>
<b>Revision 5.1.0-100</b> Changed version number in line with new versioning requirements. Revised for JBoss Enterprise Application Platform 5.1.0.GA, including: JBPAPP-4586 JBPAPP-4155 JBPAPP-4957 - Added NSAPI on Solaris section to HTTP Services chapter.	<b>Thu Sep 23 2010</b>	<b>Rebecca Newton</b>