



Red Hat Process Automation Manager 7.3

Executing a business process in Business Central

Red Hat Process Automation Manager 7.3 Executing a business process in Business Central

Red Hat Customer Content Services
brms-docs@redhat.com

Legal Notice

Copyright © 2020 Red Hat, Inc.

The text of and illustrations in this document are licensed by Red Hat under a Creative Commons Attribution–Share Alike 3.0 Unported license ("CC-BY-SA"). An explanation of CC-BY-SA is available at

<http://creativecommons.org/licenses/by-sa/3.0/>

. In accordance with CC-BY-SA, if you distribute this document or an adaptation of it, you must provide the URL for the original version.

Red Hat, as the licensor of this document, waives the right to enforce, and agrees not to assert, Section 4d of CC-BY-SA to the fullest extent permitted by applicable law.

Red Hat, Red Hat Enterprise Linux, the Shadowman logo, the Red Hat logo, JBoss, OpenShift, Fedora, the Infinity logo, and RHCE are trademarks of Red Hat, Inc., registered in the United States and other countries.

Linux[®] is the registered trademark of Linus Torvalds in the United States and other countries.

Java[®] is a registered trademark of Oracle and/or its affiliates.

XFS[®] is a trademark of Silicon Graphics International Corp. or its subsidiaries in the United States and/or other countries.

MySQL[®] is a registered trademark of MySQL AB in the United States, the European Union and other countries.

Node.js[®] is an official trademark of Joyent. Red Hat is not formally related to or endorsed by the official Joyent Node.js open source or commercial project.

The OpenStack[®] Word Mark and OpenStack logo are either registered trademarks/service marks or trademarks/service marks of the OpenStack Foundation, in the United States and other countries and are used with the OpenStack Foundation's permission. We are not affiliated with, endorsed or sponsored by the OpenStack Foundation, or the OpenStack community.

All other trademarks are the property of their respective owners.

Abstract

This document describes how to use Business Central to create a user interface for a pizza ordering process.

Table of Contents

PREFACE	3
CHAPTER 1. CREATING THE PIZZA PLACE PROJECT	4
CHAPTER 2. CREATING USERS	5
CHAPTER 3. CREATING A BUSINESS PROCESS	8
3.1. CREATING THE PIZZA ORDERS BUSINESS PROCESS	8
3.2. CREATING THE PROCESS ORDER USER TASK	9
3.3. CREATING THE CONFIRMATION USER TASK	12
3.4. ADDING AN END NODE	15
CHAPTER 4. GENERATING FORMS	16
CHAPTER 5. CUSTOMIZING FORMS	17
5.1. CUSTOMIZING THE PIZZA ORDER FORM	17
5.2. CUSTOMIZING THE PROCESS ORDER FORM	17
5.3. CUSTOMIZING THE ORDER CONFIRMATION FORM	18
CHAPTER 6. DEPLOYING THE PIZZAPLACE PROJECT	20
CHAPTER 7. EXECUTING THE PIZZAPLACE ORDER PROCESS	21
APPENDIX A. VERSIONING INFORMATION	24

PREFACE

As a business analyst or business rules developer, you can use Business Central to create forms for human tasks, providing a rich interface for collecting data. In this example, you will create a simple pizza order form that a customer (Bill) will complete and send to the pizza place. The pizza place employee (Katy) will process the order and send an order confirmation message containing the total cost for the order.

Prerequisites

- Red Hat JBoss Enterprise Application Platform 7.2 is installed. For details, see [Red Hat JBoss Enterprise Application Platform 7.2 Installation Guide](#).
- Red Hat Process Automation Manager is installed and the Process Server is configured. For more information, see [Installing and configuring Red Hat Process Automation Manager on Red Hat JBoss EAP 7.2](#).
- Red Hat Process Automation Manager is running and you can log in to Business Central with the **developer** role.

CHAPTER 1. CREATING THE PIZZA PLACE PROJECT

A project can contain data models, business processes, business rules, and forms that are specific to your project's requirements. When you create a project in Business Central it is added to the Git repository connected to Business Central.

For this project, you will create a simple business process and create and modify forms.

Procedure

1. In Business Central, go to **Menu → Design → Projects**.
2. Click **Add Project**.
3. Type **pizzaPlace** in the **Name** field of the **Add Project** window and click **Add**.

Figure 1.1. Add the pizzaPlace project

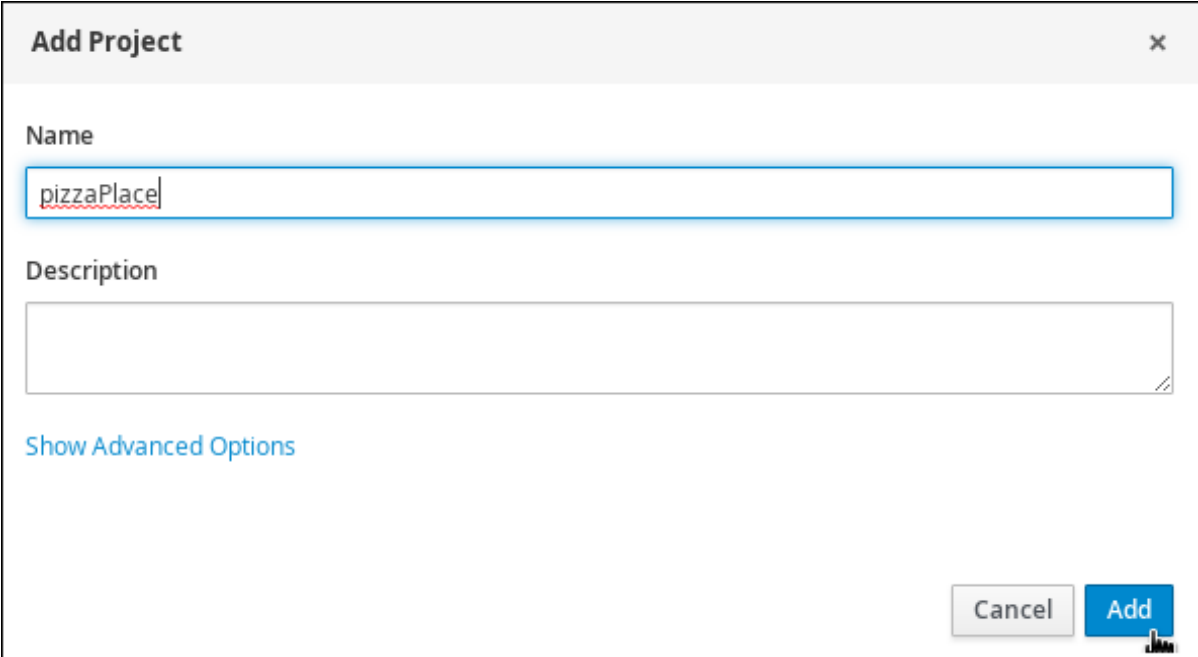

The screenshot shows a dialog box titled "Add Project" with a close button (X) in the top right corner. The dialog contains the following elements:

- Name:** A text input field containing the text "pizzaPlace".
- Description:** A larger text input field, currently empty.
- Show Advanced Options:** A blue link text located below the description field.
- Buttons:** Two buttons are located at the bottom right: a grey "Cancel" button and a blue "Add" button.

The **Assets** view of the project opens when you successfully create the project.

CHAPTER 2. CREATING USERS

You can create as many Business Central users as you require. User privileges and settings are controlled by the roles assigned to a user and the groups that a user belongs to. For this example, you must create two new users: **Katy** who will act as the pizza place employee, and **Bill** who will act as the customer placing the order. For more information on creating users, see the **Creating users** chapter of *Installing and configuring Red Hat Process Automation Manager on Red Hat JBoss EAP 7.2*.

Procedure



1. Click the gear icon  in the upper-right corner, and click **Users**.
2. Click , enter **Katy**, and click **Next**.
3. Click the **Groups** tab and click .
4. Select **rest-all** and **kie-server** in the **Group selection for Katy** window and click **Add to selected groups**.

Figure 2.1. Group selection for Katy



5. Click the **Roles** tab and click **Add roles**.

Figure 2.2. Add roles for Katy

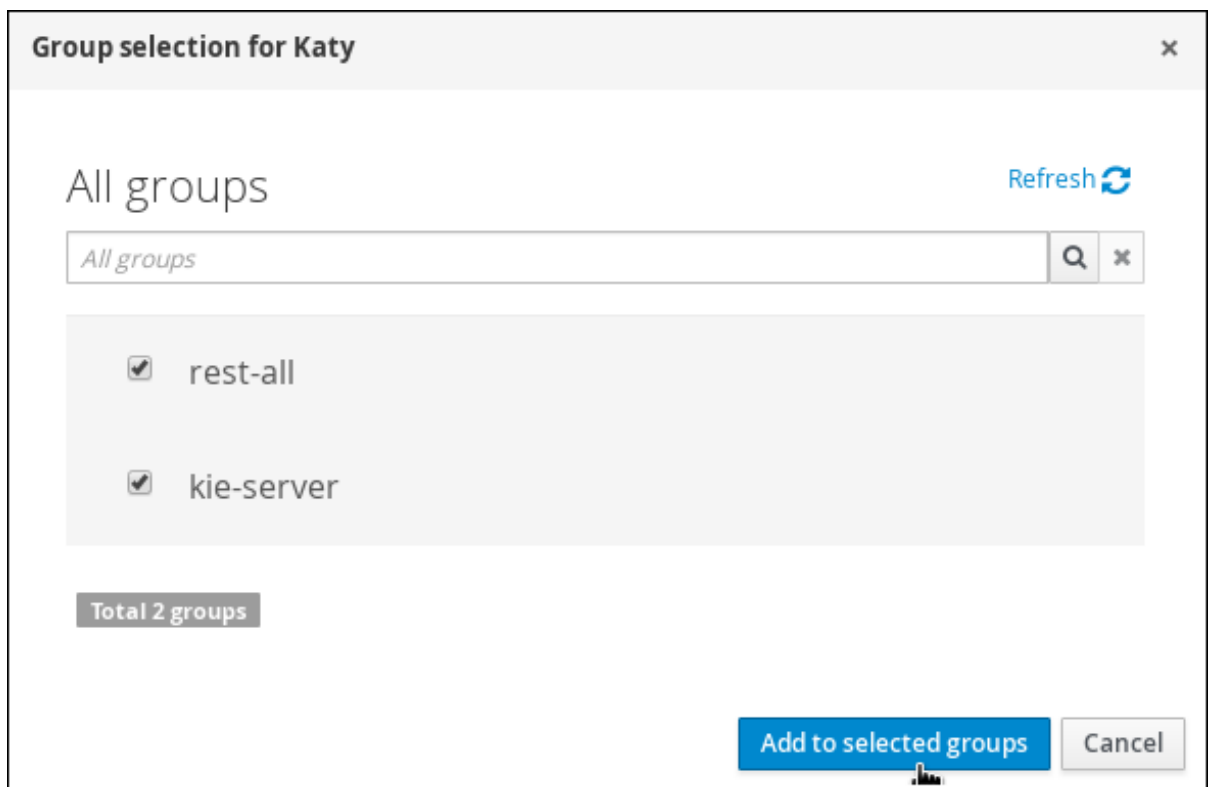
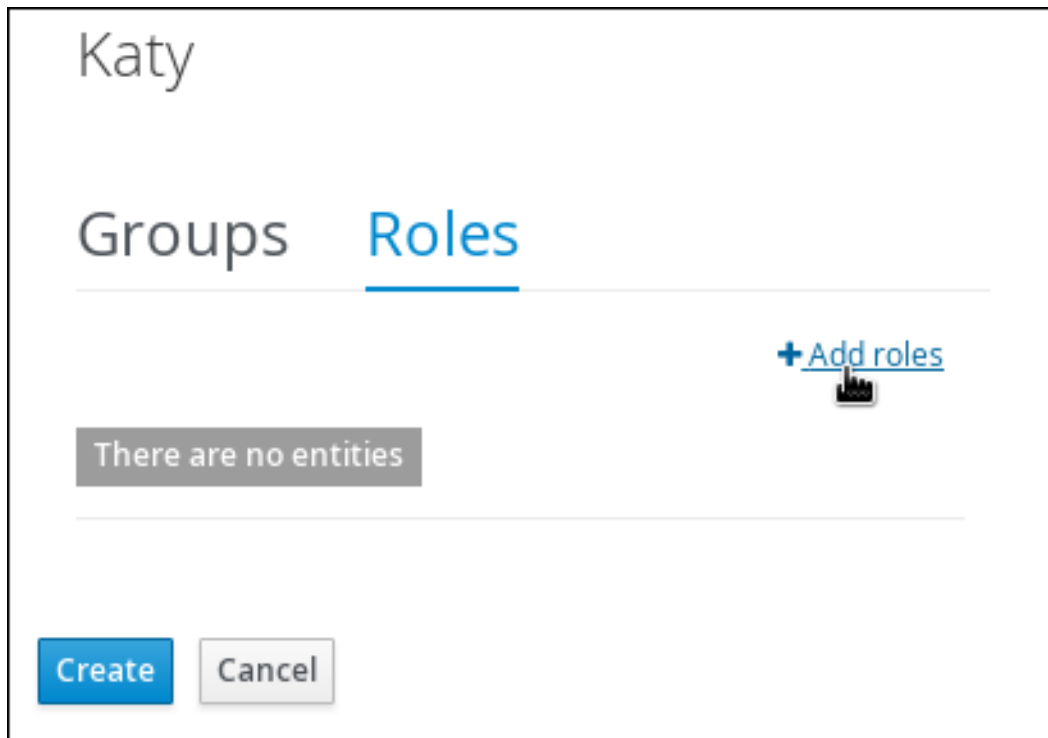

6. Select **admin** and **user** and click **Add to selected roles**
7. Click **Create** to assign **Katy** to the **admin** and **user** roles.
8. Click **Yes** to set the password to **katy** and click **Change**.
9. Create another **New user**, enter **Bill**, and click **Next**.
10. Click the **Groups** tab and click + Add to groups.
11. Select **rest-all** and **kie-server** and click **Add to selected groups**.
12. Click the **Roles** tab and click **Add roles**.

Figure 2.3. Add roles for Bill

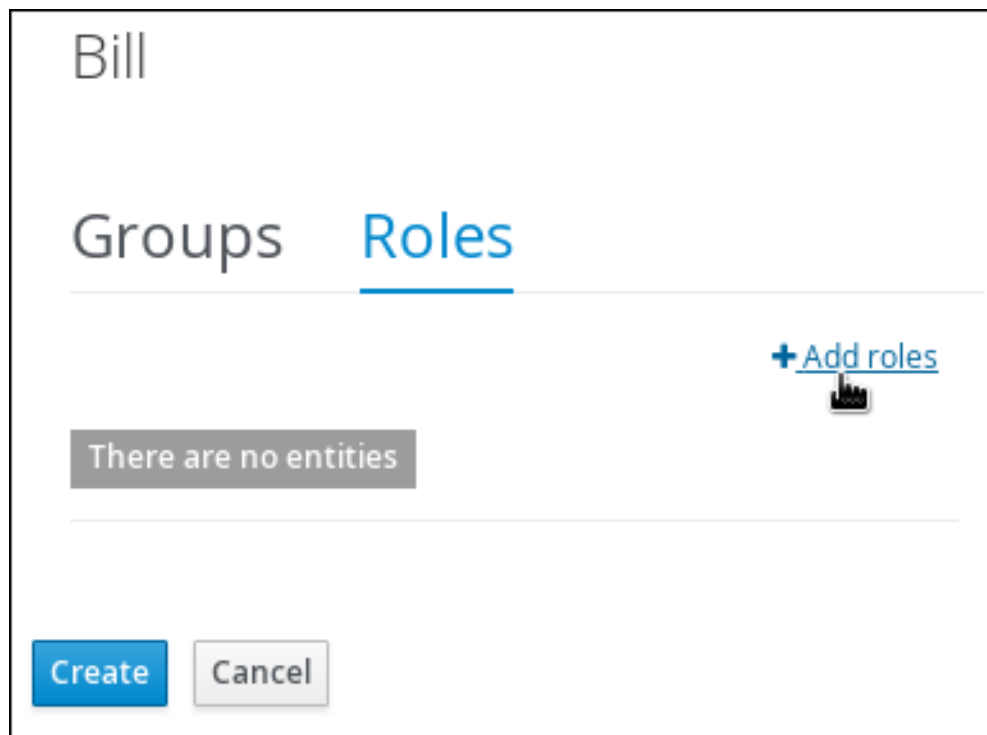

13. Select **admin** and **user** and click **Add to selected roles**
14. Click **Create** to assign **Bill** to the **admin** and **user** roles.
15. Click **Yes** to set the password to **bill** and click **Change**.

**NOTE**

Each user must be assigned to at least one role to access Business Central.

CHAPTER 3. CREATING A BUSINESS PROCESS

A business process is a graph that describes the order in which a series of steps must be executed using a flow chart. A business process consists of a collection of nodes that are linked to each other using connections. Each of the nodes represents one step in the overall process while the connections specify how to transition from one node to the other. Red Hat Process Automation Manager contains a predefined selection of node types to simplify business process creation.

Prerequisites

- Created the **pizzaPlace** project. For more information, see [Chapter 1, Creating the Pizza Place project](#).
- Created the required users. For more information, see [Chapter 2, Creating users](#).

3.1. CREATING THE PIZZA ORDERS BUSINESS PROCESS

The pizza orders business process determines whether or not the new order contains the required data before proceeding. If all of the specified data requirements are met, the order will be processed.

Procedure



1. In Business Central, go to **Menu** → **Design** → **Projects** → **pizzaPlace**.
2. Click **Add Asset** → **Business Process**.
3. In the **Create new Business Process** wizard, enter the following values:
 - a. **Business Process:** **pizzaOrders**.
 - b. **Package:** select **com.myspace.pizzaplace**.
4. Click **Ok**. The process designer opens.
5. In the upper-right corner, click the **Diagram properties**  icon.
6. Scroll down and expand **Process Data**.
7. Click  four times next to **Process Variables**, and define the following variables:

Figure 3.1. Defining variables in the Process Data window

Process Data		
Process Variables		
Name	Data Type	+
pizza	String ▼	🗑️
extraIngredients	String ▼	🗑️
drink	String ▼	🗑️
price	Float ▼	🗑️

8. In the process designer, click **Save**, then **Save**, to confirm your changes.

3.2. CREATING THE PROCESS ORDER USER TASK

Create a process order and add variables, such as the pizza ingredients and drink selection.

Procedure

1. Click the start event to create an outgoing connection to a new task.

Figure 3.2. Outgoing connection from the start event to a user task

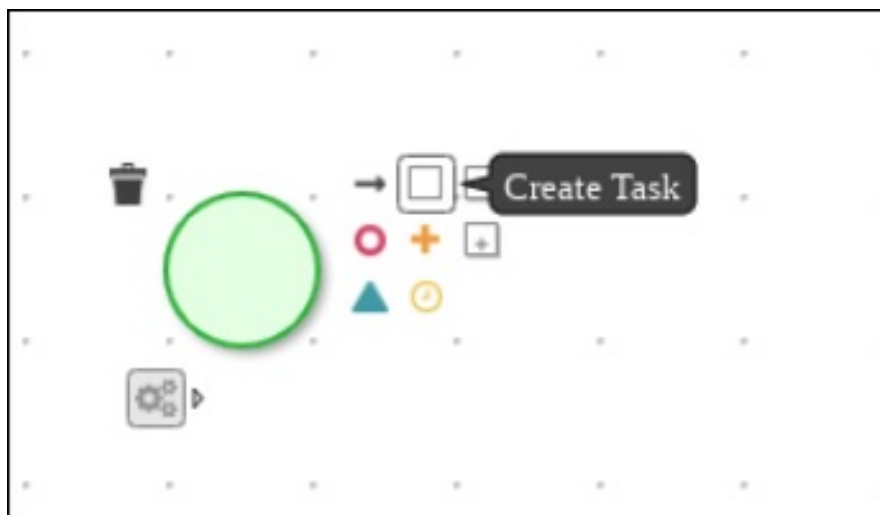

2. Convert the new task to a user task.

Figure 3.3. Convert into a User task

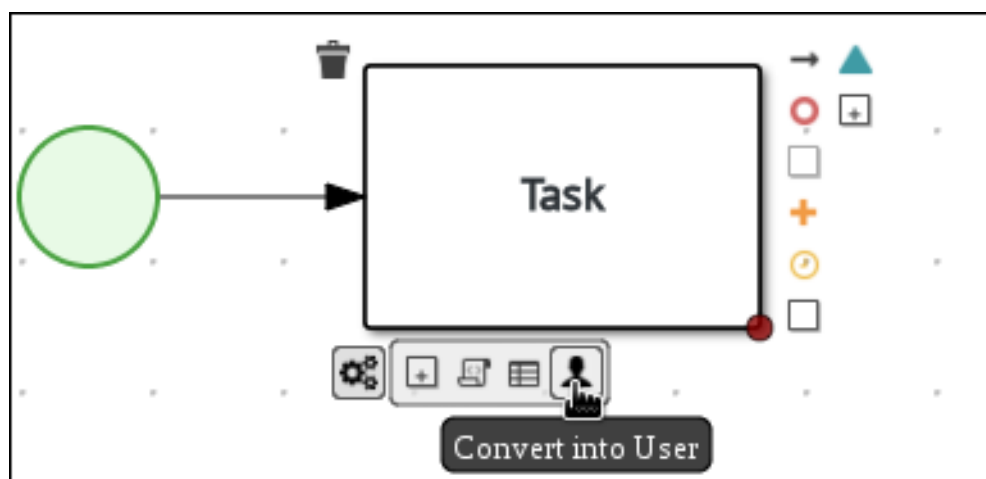

3. Click the user task and enter **Process Order** in the **Name** field.
4. Expand **Implementation/Execution** and enter the following values:
 - Task Name: **processOrder**
 - Actor: **Katy**

Figure 3.4. The Diagram properties window

Diagram properties

▼ General

Name

Documentation

▼ Implementation/Execution

Task Name

Subject

Actors

Name	
Katy	

[+ Add](#)

Groups

Name	
------	--

[+ Add](#)

Assignments

 0 data inputs, 0 data outputs

5. Click  next to **Assignments**.

6. In the **Process Order Data I/O** window, create the following input assignments:

Figure 3.5. The Process Order Data input and output assignments

Process Order Data I/O ×

Data Inputs and Assignments + Add

Name	Data Type	Source	
<input type="text" value="pizza"/>	String ▼	<input type="text" value="pizza"/>	
<input type="text" value="extraIngredients"/>	String ▼	<input type="text" value="extraIngredients"/>	
<input type="text" value="drink"/>	String ▼	<input type="text" value="drink"/>	

Data Outputs and Assignments + Add

Name	Data Type	Target	
<input type="text" value="price"/>	Float ▼	<input type="text" value="price"/>	

Cancel
Save

7. Click **Save**.

8. In the process designer, click **Save**, then **Save**, to confirm your changes.

3.3. CREATING THE CONFIRMATION USER TASK

Create an order confirmation user task, which will return the order details to the customer for confirmation before the final order is placed.

Procedure

1. Click the Process Order task to create an outgoing connection to a new task.

Figure 3.6. Outgoing connection from the Process Order task to a user task

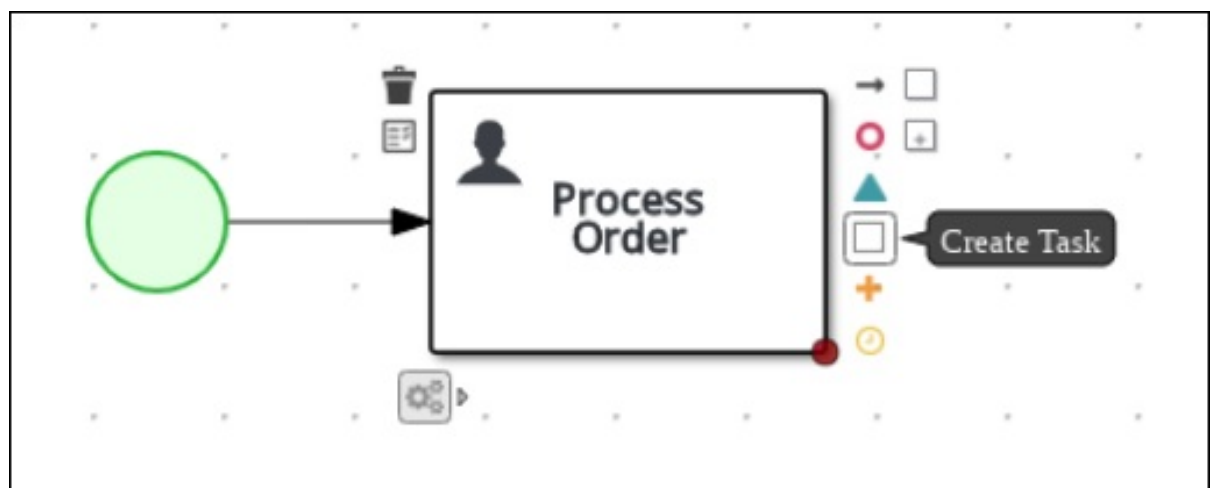

- Convert the new task to a user task.

Figure 3.7. Convert into a User task

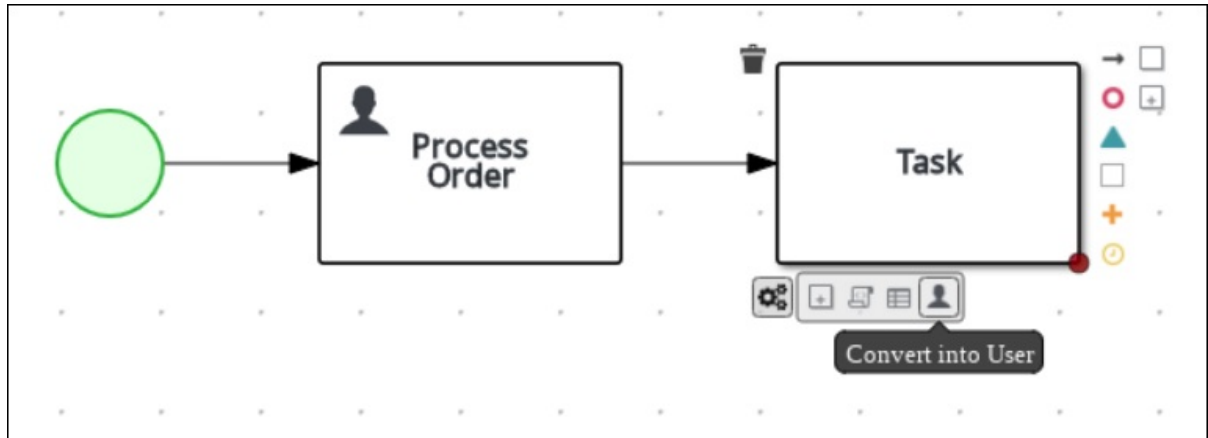

- Click the user task and enter **Confirmation** in the **Name** field.
- Expand **Implementation/Execution** and enter the following values:
 - **Task Name: confirmation**
 - **Actor: Bill**

Figure 3.8. The Diagram properties window

Diagram properties >

▼ **General**

Name

Documentation

▼ **Implementation/Execution**

Task Name

Subject

Actors

Name	
Bill	

[+ Add](#)

Groups

[+ Add](#)

Assignments

0 data inputs, 0 data outputs

- Click next to **Assignments**.
- In the **Confirmation Data I/O** window, create the following input assignments:

Figure 3.9. The Confirmation Data input and output assignments

Confirmation Data I/O ×

Data Inputs and Assignments [+ Add](#)

Name	Data Type	Source	
<input type="text" value="pizza"/>	String ▼	<input type="text" value="pizza"/>	
<input type="text" value="extraIngredients"/>	String ▼	<input type="text" value="extraIngredients"/>	
<input type="text" value="drink"/>	String ▼	<input type="text" value="drink"/>	
<input type="text" value="price"/>	Float ▼	<input type="text" value="price"/>	

Data Outputs and Assignments [+ Add](#)

[Cancel](#) [Save](#)

7. Click **Save**.
8. In the process designer, click **Save**, then **Save**, to confirm your changes.

3.4. ADDING AN END NODE

Add an end node to signify the end of the pizza order process.

Procedure

1. Click the **Confirmation** user task and connect it to an end event.

Figure 3.10. Outgoing connection from the Confirmation user task

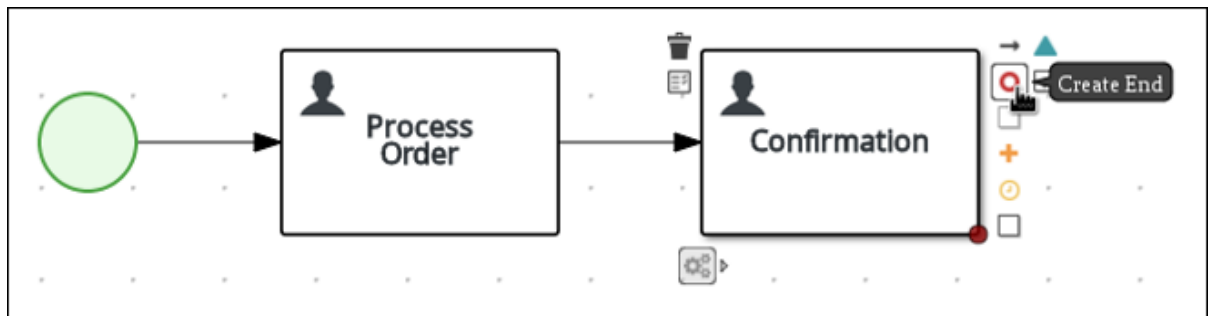

2. In the process designer, click **Save**, then **Save**, to confirm your changes.

CHAPTER 4. GENERATING FORMS

Red Hat Process Automation Manager enables you to automatically generate all forms. For this business process you will generate the **Process**, **Process Order**, and **Confirmation** forms.

Prerequisites

You have created the pizza orders business process. For more information, see [Chapter 3, Creating a Business Process](#).

Procedure

1. In Business Central, go to **Menu** → **Design** → **Projects** → **pizzaPlace** → **pizzaOrders**.
2. Select **Generate all forms** from the **Form Generation** menu.

Figure 4.1. Generate all forms menu

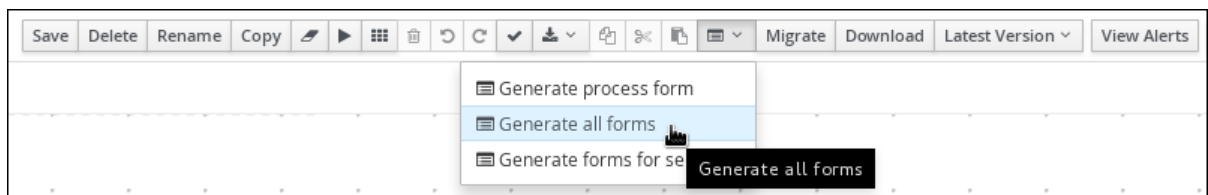

CHAPTER 5. CUSTOMIZING FORMS

Automatically generating forms saves time for basic form creation, but for most business processes, you will customize the forms to reflect exactly what you intend for the user to view and interact with.

Prerequisites

You have automatically generated the forms. For more information, see [Chapter 4, Generating forms](#).

5.1. CUSTOMIZING THE PIZZA ORDER FORM

Customize the pizza order form to ensure ease of use by defining the field types and locations.

Procedure



1. In Business Central, go to **Menu** → **Design** → **Projects** → **pizzaPlace**.
2. Click the **pizzaPlace.pizzaOrders-taskform** form.
3. Click  in the upper-right corner of the **Price** row and click **Remove**.
4. Click  in the upper-right corner of the **ExtraIngredients** row and click **Edit**.
5. Select **TextArea** from the **Field Type** menu.
6. Change both the **Label** and **Placeholder** fields to **Extra Ingredients**.
7. Click **Ok**.
8. Sort the remaining rows by dragging them to reflect the following order:

Figure 5.1. Sort the form rows



9. Click **Save**, then **Save**, to confirm your changes.

5.2. CUSTOMIZING THE PROCESS ORDER FORM

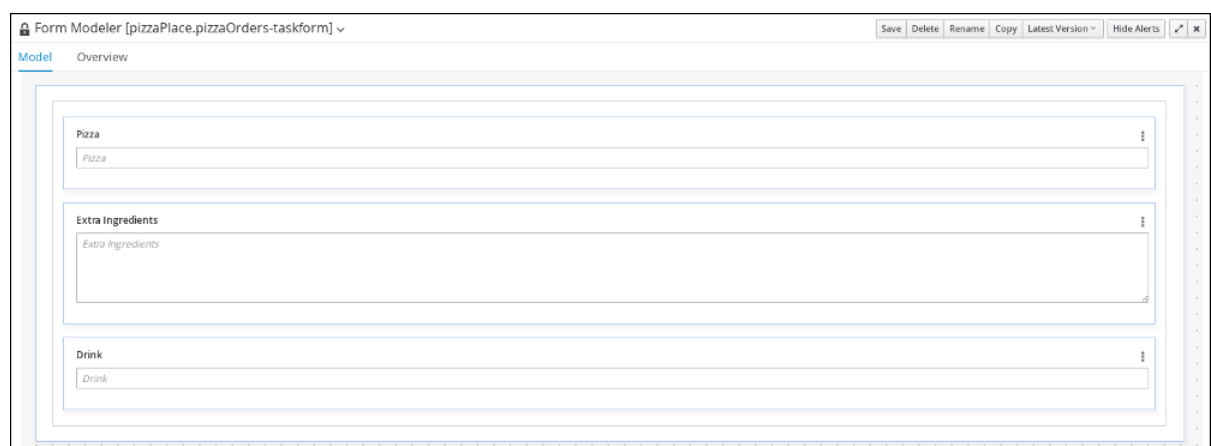
Customize the process order form to ensure ease of use by defining the field types and locations.

Procedure



1. Click **Menu** → **Design** → **Projects** → **pizzaPlace**.
2. Click the **processOrder-taskform** form.
3. Click  in the upper-right corner of the **Inputs** row, select **Edit**, and change **Inputs:** to **Order Info:**. Click **Ok**.
4. Click  in the upper-right corner of the **Outputs:** row and click **Remove**.
5. Click  in the upper-right corner of the **ExtraIngredients** row and select **Edit**.
6. From the **Field Type** menu, select **TextArea**.
7. Change both the **Label** and **Placeholder** fields to **Extra Ingredients**.
8. Click **Ok**.
9. Sort the remaining rows by dragging them to reflect the following order:

Figure 5.2. Sort the form rows



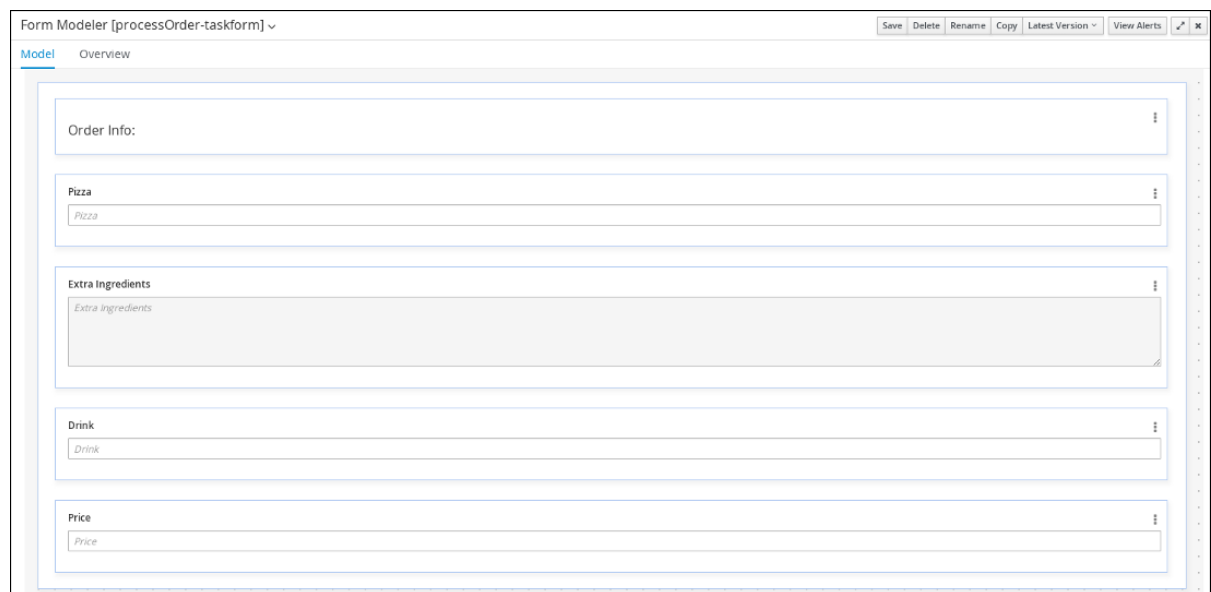

10. Click **Save**, then **Save**, to confirm your changes.

5.3. CUSTOMIZING THE ORDER CONFIRMATION FORM

Customize the order confirmation form to ensure ease of use by defining the field types and locations.

Procedure

1. Click **Menu** → **Design** → **Projects** → **pizzaPlace**.
2. Click the **confirmation-taskform** form.

3. Click  in the upper-right corner of the **Inputs** row, select **Edit**, and change **Inputs:** to **Your Order Info:**.
4. Click  in the upper-right corner of the **ExtraIngredients** row and select **Edit**.
5. From the **Field Type** menu, select **TextArea**.
6. Change both the **Label** and **PlaceHolder** fields to **Extra Ingredients**.
7. Click **Ok**.

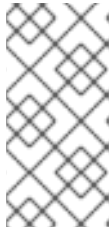

NOTE

Confirm that the **Pizza**, **Extra Ingredients**, **Drink**, and **Price** rows are marked as **Read Only** by clicking  in the upper-right corner of each and selecting **Edit**. The **Read Only** box should be selected. If not, select it and click **Ok**.

8. Sort the remaining rows by dragging them to reflect the following order:

Figure 5.3. Sort the form rows

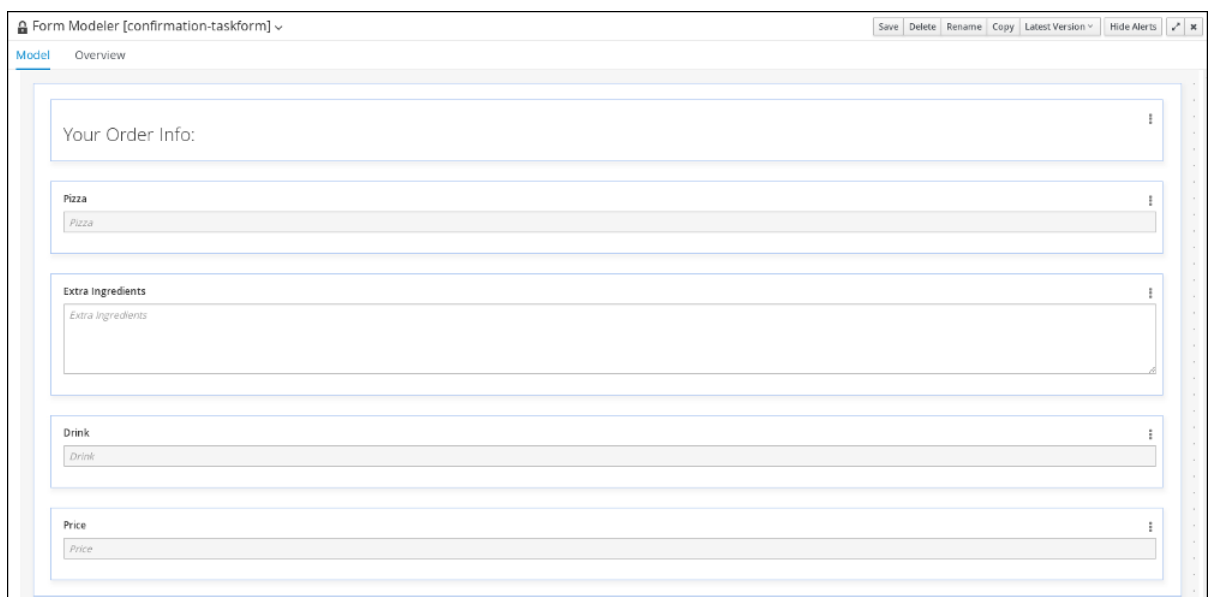

9. Click **Save**, then **Save**, to confirm your changes.

CHAPTER 6. DEPLOYING THE PIZZAPLACE PROJECT

The following chapter instructs you how to build and deploy a new instance of the **pizzaPlace** order business process in Red Hat Process Automation Manager.

Prerequisites

The Process Server is deployed and connected to the Business Central. For more information, see [Installing and configuring Red Hat Process Automation Manager on Red Hat JBoss EAP 7.2](#) .

Procedure

1. In Business Central, go to **Menu** → **Design** → **Projects**.
2. Click the project you want to deploy, for example **pizzaPlace**.
3. Click **Deploy**.



NOTE

You can also select the **Build & Install** option to build the project and publish the KJAR file to the configured Maven repository without deploying to a Process Server. In a development environment, you can click **Deploy** to deploy the built KJAR file to a Process Server without stopping any running instances (if applicable), or click **Redeploy** to deploy the built KJAR file and stop any running instances. The next time you deploy or redeploy the built KJAR, the previous deployment unit (KIE container) is automatically updated in the same target Process Server. In a production environment, the **Redeploy** option is disabled and you can click **Deploy** only to deploy the built KJAR file to a new deployment unit (KIE container) on a Process Server.

To configure the Process Server environment mode, set the **org.kie.server.mode** system property to **org.kie.server.mode=development** or **org.kie.server.mode=production**. To configure the deployment behavior for a corresponding project in Business Central, go to project **Settings** → **General Settings** → **Version** and toggle the **Development Mode** option. By default, Process Server and all new projects in Business Central are in development mode. You cannot deploy a project with **Development Mode** turned on or with a manually added **SNAPSHOT** version suffix to a Process Server that is in production mode.

CHAPTER 7. EXECUTING THE PIZZAPLACE ORDER PROCESS

Now that you have deployed the project, you can execute the project's defined functionality. For this example, you will be acting as the customer (Bill) and fill out the pizza order form. The pizza place employee (Katy) will add the order price and send the order confirmation to your task inbox.

Prerequisites

- The Process Server is deployed and connected to the Red Hat Process Automation Manager. For more information, see [Installing and configuring Red Hat Process Automation Manager on Red Hat JBoss EAP 7.2](#).
- You have deployed the **pizzaPlace** process. For more information, see [Chapter 6, Deploying the pizzaPlace project](#).

Procedure

1. Log in to Business Central as the customer:
 - **Username: Bill**
 - **Password: bill**
2. Click **Menu** → **Manage** → **Process Instances**.
3. Click **New Process Instance**, select **pizzaPlace.pizzaOrders** from the **Process definition** menu, and click **Start**.
4. Type the following values:
 - **Pizza: Large pizza**
 - **Extra Ingredients: Anchovies**
 - **Drink: Beer**

Figure 7.1. Input the order information

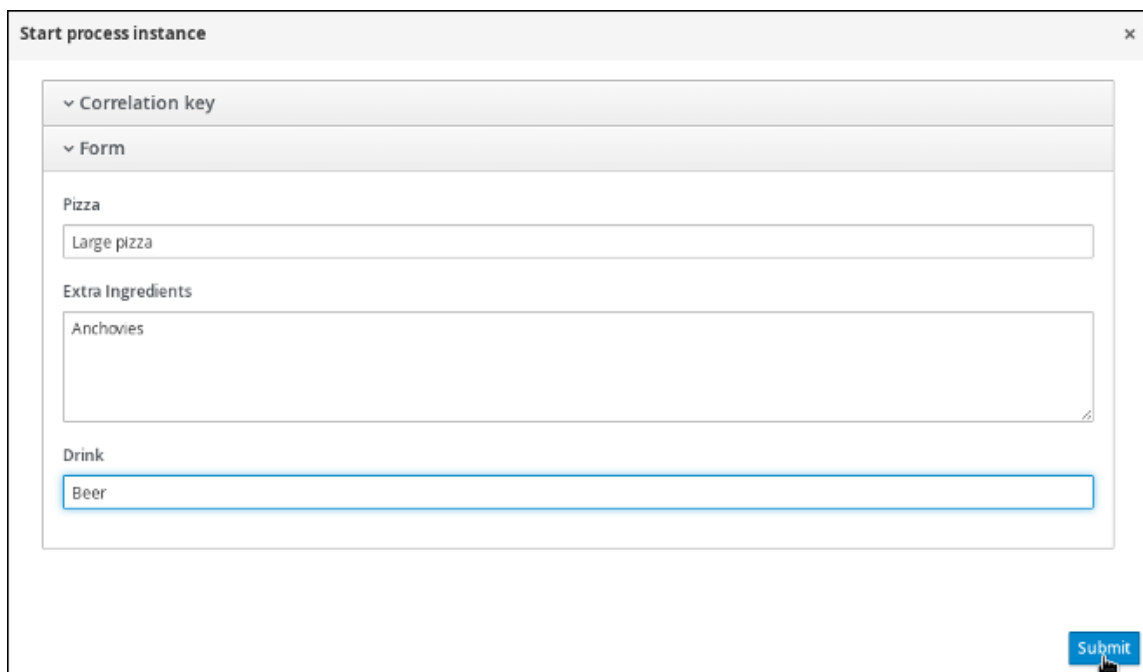

The screenshot shows a window titled "Start process instance" with a close button (x) in the top right corner. The window contains a form with the following sections:

- Correlation key**: A dropdown menu.
- Form**: A section containing three input fields:
 - Pizza**: A text input field containing "Large pizza".
 - Extra Ingredients**: A text input field containing "Anchovies".
 - Drink**: A text input field containing "Beer".
- Submit**: A blue button located at the bottom right of the form.

5. Click **Submit** to start the process instance. After starting the process instance, the **Manage Process Instances** view opens.
6. Click anywhere in the **pizzaOrders** row to view the process details.

Figure 7.2. View the process details

Id	Name	Description	Version	Last update	Errors	Actions
3	pizzaOrders	pizzaOrders	1.0	17-Jun-2018 18:59:14	0	⋮

7. Click the **Diagram** tab to view the process flow within the process diagram. The state of the process will be highlighted as it moves through each task.

Figure 7.3. View the process flow

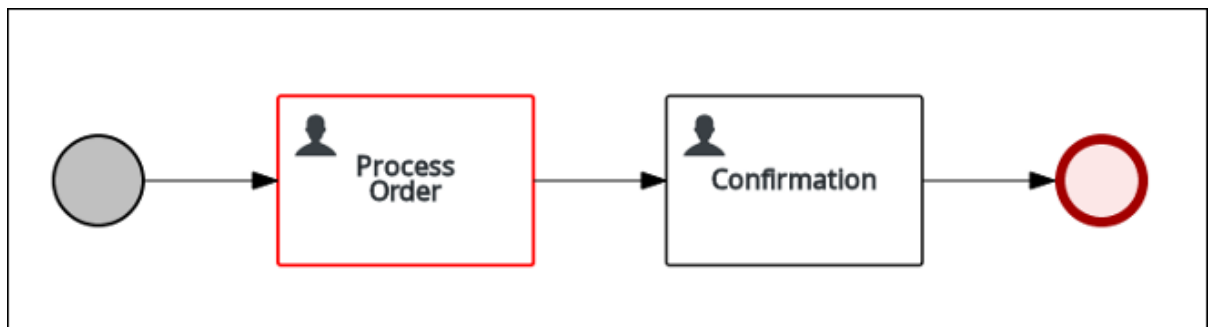

8. Log out and log back in again to Business Central as the employee:
 - Username: **Katy**
 - Password: **katy**
9. Click **Menu** → **Track** → **Task Inbox**. This will take you to the order form. This is the form that the pizza place employee (Katy) will take ownership of and return an order confirmation containing the order price.
10. Click anywhere in the **Task** row to open the order form.
11. Click **Start**, type the order total in the **Price** field, and click **Complete**.

Figure 7.4. Adding the order total price

12 - Process Order

Work Details Assignments Comments Logs

Order Info:

Pizza

Large pizza

Extra Ingredients

Anchovies

Drink

Beer

Price *

23.00

Save Release Complete

12. Log out and log back in again to Business Central as the customer:

- Username: **Bill**
- Password: **bill**

13. Click **Menu** → **Track** → **Task Inbox**. This will take you to the order confirmation form containing the order's total price.

APPENDIX A. VERSIONING INFORMATION

Documentation last updated on Wednesday, May 8, 2019.