



# Red Hat JBoss Fuse 6.2

## Security Guide

Making it safe for your systems to work together



# Red Hat JBoss Fuse 6.2 Security Guide

---

Making it safe for your systems to work together

JBoss A-MQ Docs Team

Content Services

[fuse-docs-support@redhat.com](mailto:fuse-docs-support@redhat.com)

## Legal Notice

Copyright © 2015 Red Hat.

The text of and illustrations in this document are licensed by Red Hat under a Creative Commons Attribution–Share Alike 3.0 Unported license ("CC-BY-SA"). An explanation of CC-BY-SA is available at

<http://creativecommons.org/licenses/by-sa/3.0/>

. In accordance with CC-BY-SA, if you distribute this document or an adaptation of it, you must provide the URL for the original version.

Red Hat, as the licensor of this document, waives the right to enforce, and agrees not to assert, Section 4d of CC-BY-SA to the fullest extent permitted by applicable law.

Red Hat, Red Hat Enterprise Linux, the Shadowman logo, JBoss, OpenShift, Fedora, the Infinity logo, and RHCE are trademarks of Red Hat, Inc., registered in the United States and other countries.

Linux ® is the registered trademark of Linus Torvalds in the United States and other countries.

Java ® is a registered trademark of Oracle and/or its affiliates.

XFS ® is a trademark of Silicon Graphics International Corp. or its subsidiaries in the United States and/or other countries.

MySQL ® is a registered trademark of MySQL AB in the United States, the European Union and other countries.

Node.js ® is an official trademark of Joyent. Red Hat Software Collections is not formally related to or endorsed by the official Joyent Node.js open source or commercial project.

The OpenStack ® Word Mark and OpenStack logo are either registered trademarks/service marks or trademarks/service marks of the OpenStack Foundation, in the United States and other countries and are used with the OpenStack Foundation's permission. We are not affiliated with, endorsed or sponsored by the OpenStack Foundation, or the OpenStack community.

All other trademarks are the property of their respective owners.

## Abstract

This guide describes how to secure the Red Hat JBoss Fuse container, the web console, message brokers, routing and integration components, web and RESTful services, and it provides a tutorial on LDAP authentication.

## Table of Contents

<b>CHAPTER 1. SECURITY ARCHITECTURE</b> .....	<b>3</b>
1.1. OSGI CONTAINER SECURITY	3
1.2. APACHE CAMEL SECURITY	4
<b>CHAPTER 2. SECURING THE CONTAINER</b> .....	<b>7</b>
2.1. JAAS AUTHENTICATION	7
2.2. ROLE-BASED ACCESS CONTROL	32
2.3. USING ENCRYPTED PROPERTY PLACEHOLDERS	43
2.4. ENABLING REMOTE JMX SSL	48
<b>CHAPTER 3. SECURING THE JETTY HTTP SERVER</b> .....	<b>53</b>
JETTY SERVER	53
CREATE X.509 CERTIFICATE AND PRIVATE KEY	53
ENABLING SSL/TLS	53
CONNECT TO THE SECURE CONSOLE	55
ADVANCED JETTY SECURITY CONFIGURATION	55
<b>CHAPTER 4. SECURING THE CAMEL ACTIVEMQ COMPONENT</b> .....	<b>57</b>
4.1. SECURE ACTIVEMQ CONNECTION FACTORY	57
4.2. EXAMPLE CAMEL ACTIVEMQ COMPONENT CONFIGURATION	58
<b>CHAPTER 5. SECURING THE CAMEL JETTY COMPONENT</b> .....	<b>60</b>
5.1. ENABLING SSL/TLS SECURITY	60
5.2. BASIC AUTHENTICATION WITH JAAS	66
<b>CHAPTER 6. SECURING THE CAMEL CXF COMPONENT</b> .....	<b>71</b>
6.1. THE CAMEL CXF PROXY DEMONSTRATION	71
6.2. SECURING THE WEB SERVICES PROXY	74
6.3. DEPLOYING THE APACHE CAMEL ROUTE	78
6.4. SECURING THE WEB SERVICES CLIENT	80
<b>CHAPTER 7. LDAP AUTHENTICATION TUTORIAL</b> .....	<b>87</b>
7.1. TUTORIAL OVERVIEW	87
7.2. SET-UP A DIRECTORY SERVER AND CONSOLE	87
7.3. ADD USER ENTRIES TO THE DIRECTORY SERVER	90
7.4. ENABLE LDAP AUTHENTICATION IN THE OSGI CONTAINER	94
7.5. ENABLE SSL/TLS ON THE LDAP CONNECTION	100
<b>APPENDIX A. MANAGING CERTIFICATES</b> .....	<b>105</b>
A.1. WHAT IS AN X.509 CERTIFICATE?	105
A.2. CERTIFICATION AUTHORITIES	106
A.3. CERTIFICATE CHAINING	107
A.4. SPECIAL REQUIREMENTS ON HTTPS CERTIFICATES	108
A.5. CREATING YOUR OWN CERTIFICATES	110
<b>APPENDIX B. ASN.1 AND DISTINGUISHED NAMES</b> .....	<b>117</b>
B.1. ASN.1	117
B.2. DISTINGUISHED NAMES	117
<b>INDEX</b> .....	<b>120</b>



# CHAPTER 1. SECURITY ARCHITECTURE

## Abstract

In the OSGi container, it is possible to deploy applications supporting a variety of security features. Currently, only the Java Authentication and Authorization Service (JAAS) is based on a common, container-wide infrastructure. Other security features are provided separately by the individual products and components deployed in the container.

## 1.1. OSGI CONTAINER SECURITY

### Overview

Figure 1.1, “OSGi Container Security Architecture” shows an overview of the security infrastructure that is used across the container and is accessible to all bundles deployed in the container. This common security infrastructure currently consists of a mechanism for making JAAS realms (or login modules) available to all application bundles.

Figure 1.1. OSGi Container Security Architecture

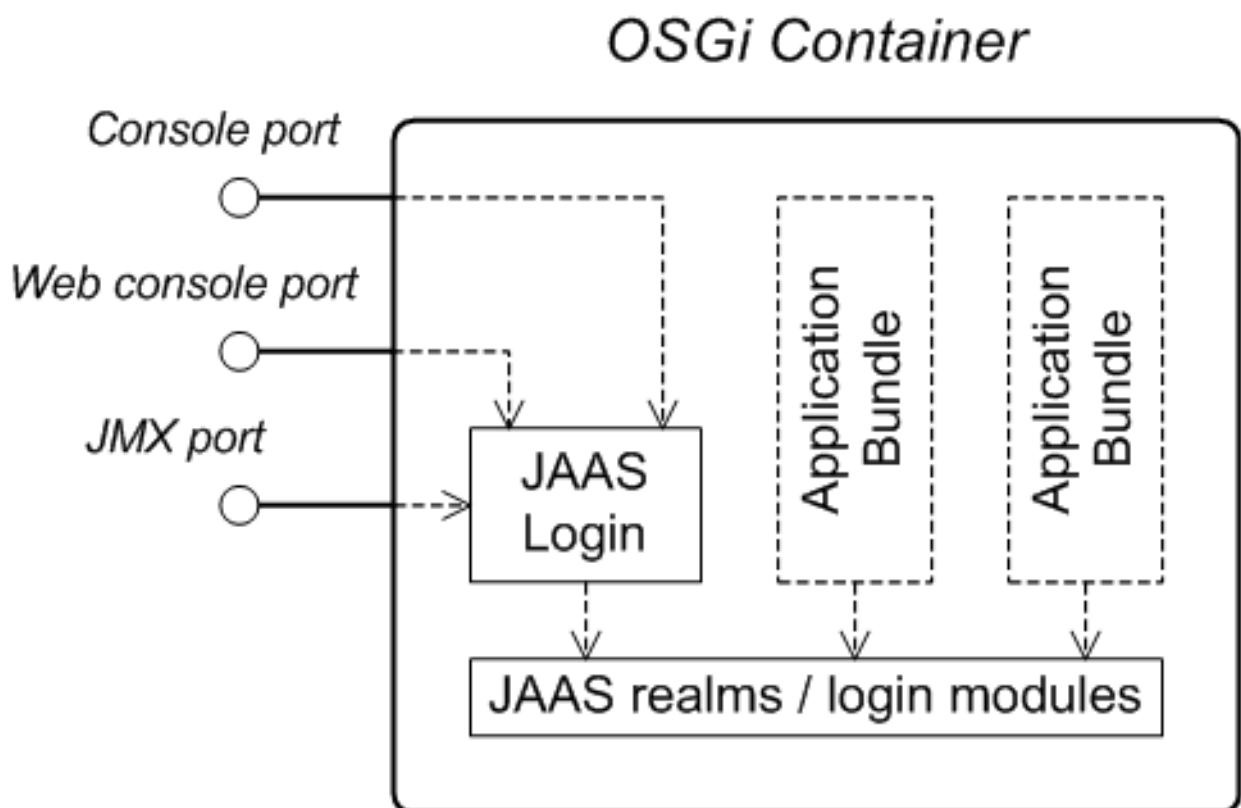

### JAAS realms

A JAAS realm or login module is a plug-in module that provides authentication and authorization data to Java applications, as defined by the [Java Authentication and Authorization Service \(JAAS\)](#) specification.

Red Hat JBoss Fuse supports a special mechanism for defining JAAS login modules (in either a Spring or a blueprint file), which makes the login module accessible to all bundles in the container. This makes it easy for multiple applications running in the OSGi container to consolidate their security data into a single JAAS realm.

## karaf realm

The OSGi container has a predefined JAAS realm, the **karaf** realm. Red Hat JBoss Fuse uses the **karaf** realm to provide authentication for remote administration of the OSGi runtime, for the Fuse Management Console, and for JMX management. The **karaf** realm uses a simple file-based repository, where authentication data is stored in the ***InstallDir/etc/users.properties*** file.

You can use the **karaf** realm in your own applications. Simply configure **karaf** as the name of the JAAS realm that you want to use. Your application then performs authentication using the data from the **users.properties** file.

## Console port

You can administer the OSGi container remotely either by connecting to the console port with a Karaf client or using the Karaf **ssh:ssh** command. The console port is secured by a JAAS login feature that connects to the **karaf** realm. Users that try to connect to the console port will be prompted to enter a username and password that must match one of the accounts from the **karaf** realm.

## JMX port

You can manage the OSGi container by connecting to the JMX port (for example, using Java's JConsole). The JMX port is also secured by a JAAS login feature that connects to the **karaf** realm.

## Application bundles and JAAS security

Any application bundles that you deploy into the OSGi container can access the container's JAAS realms. The application bundle simply references one of the existing JAAS realms by name (which corresponds to an instance of a JAAS login module).

It is essential, however, that the JAAS realms are defined using the OSGi container's own login configuration mechanism—by default, Java provides a simple file-based login configuration implementation, but you *cannot* use this implementation in the context of the OSGi container.

# 1.2. APACHE CAMEL SECURITY

## Overview

[Figure 1.2, “Apache Camel Security Architecture”](#) shows an overview of the basic options for securely routing messages between Apache Camel endpoints.



Figure 1.2. Apache Camel Security Architecture

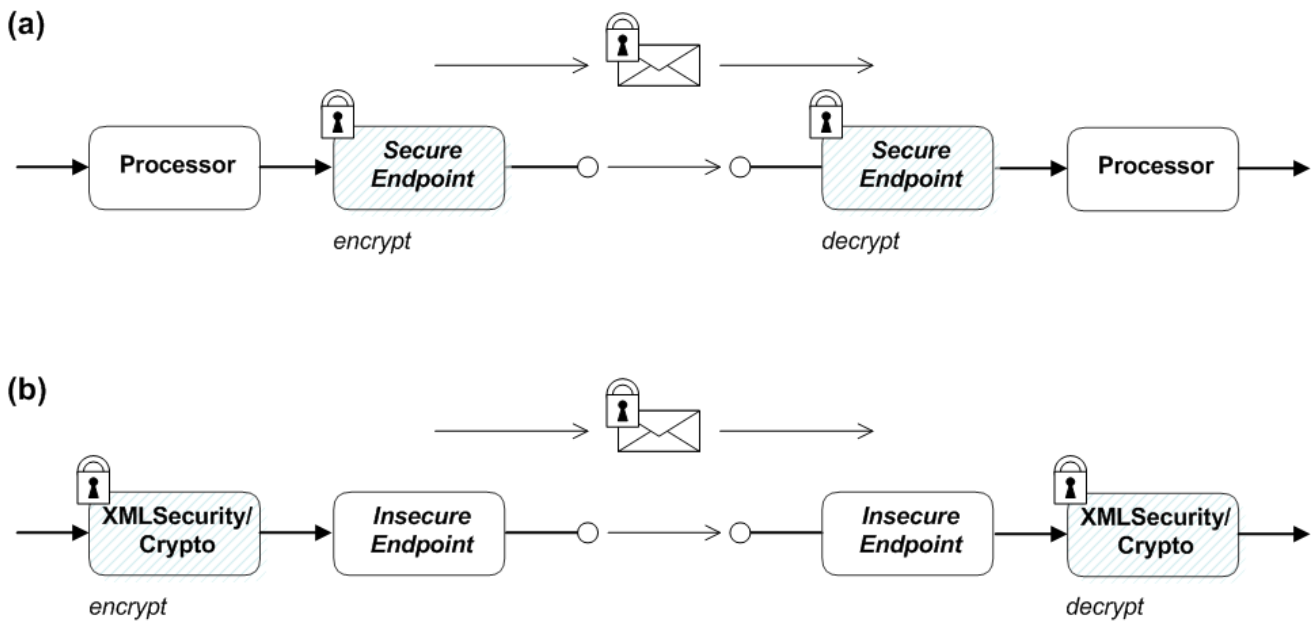

## Alternatives for Apache Camel security

As shown in [Figure 1.2, “Apache Camel Security Architecture”](#), you have the following options for securing messages:

- *Endpoint security*—part (a) shows a message sent between two routes with secure endpoints. The producer endpoint on the left opens a secure connection (typically using SSL/TLS) to the consumer endpoint on the right. Both of the endpoints support security in this scenario.

With endpoint security, it is typically possible to perform some form of peer authentication (and sometimes authorization).

- *Payload security*—part (b) shows a message sent between two routes where the endpoints are both *insecure*. To protect the message from unauthorized snooping in this case, use a *payload processor* that encrypts the message before sending and decrypts the message after it is received.

A limitation of payload security is that it does *not* provide any kind of authentication or authorization mechanisms.

## Endpoint security

There are several Camel components that support security features. It is important to note, however, that these security features are implemented by the individual components, *not* by the Camel core. Hence, the kinds of security feature that are supported, and the details of their implementation, vary from component to component. Some of the Camel components that currently support security are, as follows:

- JMS and ActiveMQ—SSL/TLS security and JAAS security for client-to-broker and broker-to-broker communication.
- Jetty—HTTP Basic Authentication and SSL/TLS security.
- CXF—SSL/TLS security and WS-Security.
- Crypto—creates and verifies digital signatures in order to guarantee message integrity.

- Netty—SSL/TLS security.
- MINA—SSL/TLS security.
- Cometd—SSL/TLS security.
- glogin and gauth—authorization in the context of Google applications.

## Payload security

Apache Camel provides the following payload security implementations, where the encryption and decryption steps are exposed as data formats on the `marshal()` and `unmarshal()` operations

- [the section called “XMLSecurity data format”](#).
- [the section called “Crypto data format”](#).

### XMLSecurity data format

The XMLSecurity data format is specifically designed to encrypt XML payloads. When using this data format, you can specify which XML element to encrypt. The default behavior is to encrypt *all* XML elements. This feature uses a symmetric encryption algorithm.

For more details, see <http://camel.apache.org/xmlsecurity-dataformat.html>.

### Crypto data format

The crypto data format is a general purpose encryption feature that can encrypt any kind of payload. It is based on the Java Cryptographic Extension and implements only symmetric (shared-key) encryption and decryption.

For more details, see <http://camel.apache.org/crypto.html>.

## CHAPTER 2. SECURING THE CONTAINER

### Abstract

The Red Hat JBoss Fuse container is secured using JAAS. By defining JAAS realms, you can configure the mechanism used to retrieve user credentials. You can also refine access to the container's administrative interfaces by changing the default roles.

## 2.1. JAAS AUTHENTICATION

### Abstract

The Java Authentication and Authorization Service (JAAS) provides a general framework for implementing authentication in a Java application. The implementation of authentication is modular, with individual JAAS modules (or plug-ins) providing the authentication implementations.

For background information about JAAS, see the [JAAS Reference Guide](#).

### 2.1.1. Default JAAS Realm

#### Overview

This section describes how to manage user data for the default JAAS realm in a standalone container.

#### Default JAAS realm

The Red Hat JBoss Fuse container has a predefined JAAS realm, the **karaf** realm, which is used by default to secure all aspects of the container.

#### How to integrate an application with JAAS

You can use the **karaf** realm in your own applications. Simply configure **karaf** as the name of the JAAS realm that you want to use.

#### Default JAAS login modules

When you start JBoss Fuse for the first time, the container is configured as a standalone container and uses the **karaf** default realm. In this default configuration, the **karaf** realm deploys four JAAS login modules, which are enabled simultaneously. To see the deployed login modules, enter the **jaas:realms** console command, as follows:

```
JBossFuse:karaf@root> jaas:realms
Index Realm          Module Class
  1 karaf
org.apache.karaf.jaas.modules.properties.PropertiesLoginModule
  2 karaf
org.apache.karaf.jaas.modules.publickey.PublickeyLoginModule
  3 karaf
```

```
org.apache.karaf.jaas.modules.audit.FileAuditLoginModule
4 karaf
org.apache.karaf.jaas.modules.audit.EventAdminAuditLoginModule
```



### IMPORTANT

In a standalone container, *both* the properties login module and the public key login module are enabled. When JAAS authenticates a user, it tries first of all to authenticate the user with the properties login module. If that fails, it then tries to authenticate the user with the public key login module. If that module also fails, an error is raised.



### NOTE

The **FileAuditLoginModule** login module and the **EventAdminAuditLoginModule** login module are used to record an audit trail of successful and failed login attempts. These login modules do *not* authenticate users.

## Configuring users in the properties login module

The properties login module is used to store username/password credentials in a flat file format. To create a new user in the properties login module, open the **InstallDir/etc/users.properties** file using a text editor and add a line with the following syntax:

```
Username=Password[,UserGroup|Role][,UserGroup|Role]...
```

For example, to create the **jdoue** user with password, **topsecret**, and role, **Administrator**, you could create an entry like the following:

```
jdoue=topsecret,Administrator
```

Where the **Administrator** role gives full administrative privileges to the **jdoue** user.

## Configuring user groups in the properties login module

Instead of (or in addition to) assigning roles directly to users, you also have the option of adding users to *user groups* in the properties login module. To create a user group in the properties login module, open the **InstallDir/etc/users.properties** file using a text editor and add a line with the following syntax:

```
_g_\:GroupName=Role1,Role2,...
```

For example, to create the **admingroup** user group with the roles, **SuperUser** and **Administrator**, you could create an entry like the following:

```
_g_\:admingroup=SuperUser,Administrator
```

You could then add the **majorclanger** user to the **admingroup**, by creating the following user entry:

```
majorclanger=secretpass,_g_\:admingroup
```

## Configuring the public key login module

The public key login module is used to store SSH public key credentials in a flat file format. To create a new user in the public key login module, open the ***InstallDir/etc/keys.properties*** file using a text editor and add a line with the following syntax:

```
Username=PublicKey[,UserGroup|Role][,UserGroup|Role]...
```

For example, you can create the **jdoe** user with the **Administrator** role by adding the following entry to the ***InstallDir/etc/keys.properties*** file (on a single line):

```
jdoe=AAAAB3NzaC1kc3MAAACBAP1/U4EddRIpUt9KnC7s50f2EbdSP09EAMMeP4C2USZpRV1AI
1H7WT2NWPq/xfw6MPbLm1Vs14E7
gB00b/JmYLdrmVC1pJ+f6AR7ECLCT7up1/63xhv401fnfqimFQ8E+4P208UewwI1VBNaFpEy9n
Xzrith1yrv8iIDGZ3RSAHHAAAAAFQCX
YFCPFSMLzLKSuYKi64QL8Fgc9QAAAEAE9+GghdabPd7LvKtcNrhXuXmUr7v60uqC+VdMCz0Hgm
dRWVe0utRZT+ZxBxCBGLRjFnEj6Ewo
Fh03zwkyjMim4TwWeotifI0o4K0uHiuzpnWRbqN/C/ohNWLx+2J6ASQ7zKTxvqhRkImog9/hWu
WfBpKLZl6Ae1U1ZAFM0/7PSSoAAACB
AKKSU2PF1/q0LxIwmBZPPIcJshVe7bVUpFvy13BbJDow8rXfSk18w0630zP/qLmcJM0+JbcRU/
53Jj7uyk31drV2qxhI0sLDC9dGCWj4
7Y7TyhPdXh/0dthTRBy6bqGtRPxGa7gJov1xm/UuYYXPIUR/3x9MAZvZ5xvE0kYX0+rx,Admin
istrator
```

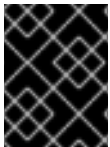

## IMPORTANT

Do not insert the entire contents of an **id\_rsa.pub** file here. Insert just the block of symbols which represents the public key itself.

## Configuring user groups in the public key login module

Instead of (or in addition to) assigning roles directly to users, you also have the option of adding users to *user groups* in the public key login module. To create a user group in the public key login module, open the ***InstallDir/etc/keys.properties*** file using a text editor and add a line with the following syntax:

```
_g_\:GroupName=Role1,Role2,...
```

For example, to create the **admingroup** user group with the roles, **SuperUser** and **Administrator**, you could create an entry like the following:

```
_g_\:admingroup=SuperUser,Administrator
```

You could then add the **jdoe** user to the **admingroup**, by creating the following user entry:

```
jdoe=AAAAB3NzaC1kc3MAAACBAP1/U4EddRIpUt9KnC7s50f2EbdSP09EAMMeP4C2USZpRV1AI
1H7WT2NWPq/xfw6MPbLm1Vs14E7
gB00b/JmYLdrmVC1pJ+f6AR7ECLCT7up1/63xhv401fnfqimFQ8E+4P208UewwI1VBNaFpEy9n
Xzrith1yrv8iIDGZ3RSAHHAAAAAFQCX
YFCPFSMLzLKSuYKi64QL8Fgc9QAAAEAE9+GghdabPd7LvKtcNrhXuXmUr7v60uqC+VdMCz0Hgm
dRWVe0utRZT+ZxBxCBGLRjFnEj6Ewo
Fh03zwkyjMim4TwWeotifI0o4K0uHiuzpnWRbqN/C/ohNWLx+2J6ASQ7zKTxvqhRkImog9/hWu
WfBpKLZl6Ae1U1ZAFM0/7PSSoAAACB
AKKSU2PF1/q0LxIwmBZPPIcJshVe7bVUpFvy13BbJDow8rXfSk18w0630zP/qLmcJM0+JbcRU/
```

```
53Jj7uyk31drV2qxhI0sLDC9dGCWj4
7Y7TyhPdXh/0dthTRBy6bqGtRPxGa7gJov1xm/UuYYXPIUR/3x9MAZvZ5xvE0kYX0+rx,_g_:a
dmingroup
```

## Encrypting the stored passwords

By default, passwords are stored in the `InstallDir/etc/users.properties` file in plaintext format. To protect the passwords in this file, you must set the file permissions of the `users.properties` file so that it can be read only by administrators. To provide additional protection, you can optionally encrypt the stored passwords using a message digest algorithm.

To enable the password encryption feature, edit the `InstallDir/etc/org.apache.karaf.jaas.cfg` file and set the encryption properties as described in the comments. For example, the following settings would enable basic encryption using the MD5 message digest algorithm:

```
encryption.enabled = true
encryption.name = basic
encryption.prefix = {CRYPT}
encryption.suffix = {CRYPT}
encryption.algorithm = MD5
encryption.encoding = hexadecimal
```



### NOTE

The encryption settings in the `org.apache.karaf.jaas.cfg` file are applied *only* to the default `karaf` realm in a standalone container. They have no effect on a Fabric container and no effect on a custom realm.

For more details about password encryption, see [Section 2.1.8, “Encrypting Stored Passwords”](#).

## Overriding the default realm

If you want to customise the JAAS realm, the most convenient approach to take is to override the default `karaf` realm by defining a higher ranking `karaf` realm. This ensures that all of the Red Hat JBoss Fuse security components switch to use your custom realm. For details of how to define and deploy custom JAAS realms, see [Section 2.1.2, “Defining JAAS Realms”](#).

## 2.1.2. Defining JAAS Realms

### Overview

When defining a JAAS realm in the OSGi container, you *cannot* put the definitions in a conventional JAAS [login configuration](#) file. Instead, the OSGi container uses a special `jaas:config` element for defining JAAS realms in a blueprint configuration file. The JAAS realms defined in this way are made available to *all* of the application bundles deployed in the container, making it possible to share the JAAS security infrastructure across the whole container.

### Namespace

The `jaas:config` element is defined in the `http://karaf.apache.org/xmlns/jaas/v1.0.0` namespace. When defining a JAAS realm you will need to include the line shown in [Example 2.1, “JAAS Blueprint Namespace”](#).

### Example 2.1. JAAS Blueprint Namespace

```
xmlns:jaas="http://karaf.apache.org/xmlns/jaas/v1.0.0"
```

## Configuring a JAAS realm

The syntax for the `jaas:config` element is shown in [Example 2.2, “Defining a JAAS Realm in Blueprint XML”](#).

### Example 2.2. Defining a JAAS Realm in Blueprint XML

```
<blueprint xmlns="http://www.osgi.org/xmlns/blueprint/v1.0.0"
  xmlns:jaas="http://karaf.apache.org/xmlns/jaas/v1.0.0">

  <jaas:config name="JaasRealmName"
    [rank="IntegerRank"]>
    <jaas:module className="LoginModuleClassName"
      [flags="
[required|requisite|sufficient|optional]">
      Property=Value
      ...
    </jaas:module>
    ...
    <!-- Can optionally define multiple modules -->
    ...
  </jaas:config>
</blueprint>
```

The elements are used as follows:

#### `jaas:config`

Defines the JAAS realm. It has the following attributes:

- **name**—specifies the name of the JAAS realm.
- **rank**—specifies an optional rank for resolving naming conflicts between JAAS realms . When two or more JAAS realms are registered under the same name, the OSGi container always picks the realm instance with the highest rank. If you decide to override the default realm, **karaf**, you should specify a **rank** of **100** or more, so that it overrides all of the previously installed **karaf** realms (in the context of Fabric, you need to override the default **ZookeeperLoginModule**, which has a rank of **99**).

#### `jaas:module`

Defines a JAAS login module in the current realm. `jaas:module` has the following attributes:

- **className**—the fully-qualified class name of a JAAS login module. The specified class must be available from the bundle classloader.
- **flags**—determines what happens upon success or failure of the login operation. [Table 2.1, “Flags for Defining a JAAS Module”](#) describes the valid values.

**Table 2.1. Flags for Defining a JAAS Module**

Value	Description
<b>required</b>	Authentication of this login module must succeed. Always proceed to the next login module in this entry, irrespective of success or failure.
<b>requisite</b>	Authentication of this login module must succeed. If success, proceed to the next login module; if failure, return immediately without processing the remaining login modules.
<b>sufficient</b>	Authentication of this login module is not required to succeed. If success, return immediately without processing the remaining login modules; if failure, proceed to the next login module.
<b>optional</b>	Authentication of this login module is not required to succeed. Always proceed to the next login module in this entry, irrespective of success or failure.

The contents of a `jaas:module` element is a space separated list of property settings, which are used to initialize the JAAS login module instance. The specific properties are determined by the JAAS login module and must be put into the proper format.

**NOTE**

You can define multiple login modules in a realm.

## Converting standard JAAS login properties to XML

Red Hat JBoss Fuse uses the same properties as a standard Java login configuration file, however Red Hat JBoss Fuse requires that they are specified slightly differently. To see how the Red Hat JBoss Fuse approach to defining JAAS realms compares with the standard Java login configuration file approach, consider how to convert the login configuration shown in [Example 2.3, “Standard JAAS Properties”](#), which defines the **PropertiesLogin** realm using the Red Hat JBoss Fuse properties login module class, **PropertiesLoginModule**:

### Example 2.3. Standard JAAS Properties

```
PropertiesLogin {
```



```

    org.apache.activemq.jaas.PropertiesLoginModule required
    org.apache.activemq.jaas.properties.user="users.properties"
    org.apache.activemq.jaas.properties.group="groups.properties";
};

```

The equivalent JAAS realm definition, using the `jaas:config` element in a blueprint file, is shown in [Example 2.4, “Blueprint JAAS Properties”](#).

#### Example 2.4. Blueprint JAAS Properties

```

<blueprint xmlns="http://www.osgi.org/xmlns/blueprint/v1.0.0"
           xmlns:jaas="http://karaf.apache.org/xmlns/jaas/v1.0.0"

  xmlns:ext="http://aries.apache.org/blueprint/xmlns/blueprint-
  ext/v1.0.0">

  <jaas:config name="PropertiesLogin">
    <jaas:module
      className="org.apache.activemq.jaas.PropertiesLoginModule"
      flags="required">
      org.apache.activemq.jaas.properties.user=users.properties
      org.apache.activemq.jaas.properties.group=groups.properties
    </jaas:module>
  </jaas:config>

</blueprint>

```

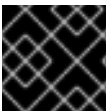

#### IMPORTANT

You **do not** use double quotes for JAAS properties in the blueprint configuration.

#### Example

Red Hat JBoss Fuse also provides an adapter that enables you to store JAAS authentication data in an X.500 server. [Example 2.5, “Configuring a JAAS Realm”](#) defines the **LDAPLogin** realm to use Red Hat JBoss Fuse's **LDAPLoginModule** class, which connects to the LDAP server located at `ldap://localhost:10389`.

#### Example 2.5. Configuring a JAAS Realm

```

<?xml version="1.0" encoding="UTF-8"?>
<blueprint xmlns="http://www.osgi.org/xmlns/blueprint/v1.0.0"
           xmlns:jaas="http://karaf.apache.org/xmlns/jaas/v1.0.0"
           xmlns:ext="http://aries.apache.org/blueprint/xmlns/blueprint-
           ext/v1.0.0">

  <jaas:config name="LDAPLogin" rank="200">
    <jaas:module
      className="org.apache.karaf.jaas.modules.ldap.LDAPLoginModule"
      flags="required">
      initialContextFactory=com.sun.jndi.ldap.LdapCtxFactory
    </jaas:module>
  </jaas:config>

</blueprint>

```

```

connection.username=uid=admin,ou=system
connection.password=secret
connection.protocol=
connection.url = ldap://localhost:10389
user.base.dn = ou=users,ou=system
user.filter = (uid=%u)
user.search.subtree = true
role.base.dn = ou=users,ou=system
role.filter = (uid=%u)
role.name.attribute = ou
role.search.subtree = true
authentication = simple
</jaas:module>
</jaas:config>
</blueprint>

```

For a detailed description and example of using the LDAP login module, see [Section 2.1.7, “JAAS LDAP Login Module”](#).

### 2.1.3. JAAS Properties Login Module

#### Overview

The JAAS properties login module stores user data in a flat file format (where the stored passwords can optionally be encrypted using a message digest algorithm). The user data can either be edited directly, using a simple text editor, or managed using the `jaas:*` console commands.

For example, a standalone container uses the JAAS properties login module by default and stores the associated user data in the `installDir/etc/users.properties` file.

#### Supported credentials

The JAAS properties login module authenticates username/password credentials, returning the list of roles associated with the authenticated user.

#### Implementation classes

The following classes implement the JAAS properties login module:

##### `org.apache.karaf.jaas.modules.properties.PropertiesLoginModule`

Implements the JAAS login module.

##### `org.apache.karaf.jaas.modules.properties.PropertiesBackingEngineFactory`

Must be exposed as an OSGi service. This service makes it possible for you to manage the user data using the `jaas:*` console commands from the Apache Karaf shell (see [chapter “JAAS Console Commands”](#) in [“Console Reference”](#)).

#### Options

The JAAS properties login module supports the following options:

## users

Location of the user properties file.

## Format of the user properties file

The user properties file is used to store username, password, and role data for the properties login module. Each user is represented by a single line in the user properties file, where a line has the following form:

```
Username=Password[,UserGroup|Role][,UserGroup|Role]...
```

User groups can also be defined in this file, where each user group is represented by a single line in the following format:

```
_g_\:GroupName=Role1[,Role2]...
```

For example, you can define the users, **bigcheese** and **guest**, and the user groups, **admingroup** and **guestgroup**, as follows:

```
# Users
bigcheese=cheesepass,_g_:admingroup
guest=guestpass,_g_:guestgroup

# Groups
_g_\:admingroup=SuperUser,Administrator
_g_\:guestgroup=Monitor
```

## Sample Blueprint configuration

The following Blueprint configuration shows how to define a new **karaf** realm using the properties login module, where the default **karaf** realm is overridden by setting the **rank** attribute to **200**:

```
<?xml version="1.0" encoding="UTF-8"?>
<blueprint xmlns="http://www.osgi.org/xmlns/blueprint/v1.0.0"
  xmlns:jaas="http://karaf.apache.org/xmlns/jaas/v1.0.0"
  xmlns:cm="http://aries.apache.org/blueprint/xmlns/blueprint-
cm/v1.1.0"
  xmlns:ext="http://aries.apache.org/blueprint/xmlns/blueprint-
ext/v1.0.0">

  <type-converters>
    <bean
class="org.apache.karaf.jaas.modules.properties.PropertiesConverter"/>
  </type-converters>

  <!-- Allow usage of System properties, especially the karaf.base
property -->
  <ext:property-placeholder placeholder-prefix="$[" placeholder-
suffix="]"/>

  <jaas:config name="karaf" rank="200">
    <jaas:module
```

```

className="org.apache.karaf.jaas.modules.properties.PropertiesLoginModule"
    flags="required">
    users = $[karaf.base]/etc/users.properties
  </jaas:module>
</jaas:config>

<!-- The Backing Engine Factory Service for the PropertiesLoginModule
-->
  <service
interface="org.apache.karaf.jaas.modules.BackingEngineFactory">
    <bean
class="org.apache.karaf.jaas.modules.properties.PropertiesBackingEngineFac
tory"/>
    </service>

</blueprint>

```

Remember to export the **BackingEngineFactory** bean as an OSGi service, so that the **jaas:\*** console commands can manage the user data.

## 2.1.4. JAAS OSGi Config Login Module

### Overview

The JAAS OSGi config login modules leverages the *OSGi Config Admin Service* to store user data. This login module is fairly similar to the JAAS properties login module (for example, the syntax of the user entries is the same), but the mechanism for retrieving user data is based on the OSGi Config Admin Service.

The user data can be edited directly by creating a corresponding OSGi configuration file, **etc/PersistentID.cfg** or using any method of configuration that is supported by the OSGi Config Admin Service. The **jaas:\*** console commands are not supported, however.

### Supported credentials

The JAAS OSGi config login module authenticates username/password credentials, returning the list of roles associated with the authenticated user.

### Implementation classes

The following classes implement the JAAS OSGi config login module:

#### **org.apache.karaf.jaas.modules.osgi.OsgiConfigLoginModule**

Implements the JAAS login module.

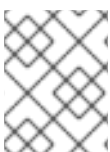

### NOTE

There is no backing engine factory for the OSGi config login module, which means that this module cannot be managed using the **jaas:\*** console commands.

### Options

The JAAS OSGi config login module supports the following options:

## pid

The *persistent ID* of the OSGi configuration containing the user data. In the OSGi Config Admin standard, a persistent ID references a set of related configuration properties.

### Location of the configuration file

The location of the configuration file follows the usual convention where the configuration for the persistent ID, *PersistentID*, is stored in the following file:

```
InstallDir/etc/PersistentID.cfg
```

### Format of the configuration file

The *PersistentID.cfg* configuration file is used to store username, password, and role data for the OSGi config login module. Each user is represented by a single line in the configuration file, where a line has the following form:

```
Username=Password[,Role][,Role]...
```



#### NOTE

User groups are *not* supported in the JAAS OSGi config login module.

### Sample Blueprint configuration

The following Blueprint configuration shows how to define a new **karaf** realm using the OSGi config login module, where the default **karaf** realm is overridden by setting the **rank** attribute to **200**:

```
<?xml version="1.0" encoding="UTF-8"?>
<blueprint xmlns="http://www.osgi.org/xmlns/blueprint/v1.0.0"
  xmlns:jaas="http://karaf.apache.org/xmlns/jaas/v1.0.0"
  xmlns:cm="http://aries.apache.org/blueprint/xmlns/blueprint-
cm/v1.1.0"
  xmlns:ext="http://aries.apache.org/blueprint/xmlns/blueprint-
ext/v1.0.0">

  <jaas:config name="karaf" rank="200">
    <jaas:module
      className="org.apache.karaf.jaas.modules.osgi.OsgiConfigLoginModule"
      flags="required">
      pid = org.jboss.example.osgiconfigloginmodule
    </jaas:module>
  </jaas:config>

</blueprint>
```

In this example, the user data will be stored in the file, *InstallDir/etc/org.jboss.example.osgiconfigloginmodule.cfg*, and it is not possible to edit the configuration using the `jaas:*` console commands.

### 2.1.5. JAAS Public Key Login Module

## Overview

The JAAS public key login module stores user data in a flat file format, which can be edited directly using a simple text editor. The `jaas : *` console commands are not supported, however.

For example, a standalone container uses the JAAS public key login module by default and stores the associated user data in the `InstallDir/etc/keys.properties` file.

## Supported credentials

The JAAS public key login module authenticates SSH key credentials. When a user tries to log in, the SSH protocol uses the stored public key to challenge the user. The user must possess the corresponding private key in order to answer the challenge. If login is successful, the login module returns the list of roles associated with the user.

## Implementation classes

The following classes implement the JAAS public key login module:

### `org.apache.karaf.jaas.modules.publickey.PublickeyLoginModule`

Implements the JAAS login module.



### NOTE

There is no backing engine factory for the public key login module, which means that this module cannot be managed using the `jaas : *` console commands.

## Options

The JAAS public key login module supports the following options:

### `users`

Location of the user properties file for the public key login module.

## Format of the keys properties file

The `keys.properties` file is used to store username, public key, and role data for the public key login module. Each user is represented by a single line in the keys properties file, where a line has the following form:

```
Username=PublicKey[,UserGroup|Role][,UserGroup|Role]...
```

Where the `PublicKey` is the public key part of an SSH key pair (typically found in a user's home directory in `~/.ssh/id_rsa.pub` in a UNIX system).

For example, to create the user `jdope` with the `Administrator` role, you would create an entry like the following:

```
jdope=AAAAB3NzaC1kc3MAAACBAP1/U4EddRIpUt9KnC7s50f2EbdSP09EAMMeP4C2USZpRV1AI
1H7WT2NWPq/xfW6MPbLm1Vs14E7
gB00b/JmYLDrmVC1pJ+f6AR7ECLCT7up1/63xhv401fnfqimFQ8E+4P208UewwI1VBNaFpEy9n
```

```
Xzrith1yrv8iIDGZ3RSAHHAAAFQCX
YFCPFSMLzLKSuYKi64QL8Fgc9QAAAnEA9+GghdabPd7LvKtcNrhXuXmUr7v60uqC+VdMCz0Hgm
dRWVe0utRZT+ZxBxCBGLRjFnEj6Ewo
Fh03zwkyjMim4TwWeotifI0o4K0uHiuzpnWRbqN/C/ohNWLx+2J6ASQ7zKTxvqhRkImog9/hWu
WfBpKLZ16Ae1U1ZAFM0/7PSSoAAACB
AKKSU2PF1/q0LxIwmBZPPIcJshVe7bVUpFvy13BbJDow8rXfsl8w0630zP/qLmcJM0+JbcRU/
53Jj7uyk31drV2qxhI0sLDC9dGCWj4
7Y7TyhPdXh/0dthTRBy6bqGtRPxGa7gJov1xm/UuYYXPIUR/3x9MAZvZ5xvE0kYX0+rx, Admin
istrator
```



## IMPORTANT

Do not insert the entire contents of the `id_rsa.pub` file here. Insert just the block of symbols which represents the public key itself.

User groups can also be defined in this file, where each user group is represented by a single line in the following format:

```
_g_\:GroupName=Role1[,Role2]...
```

## Sample Blueprint configuration

The following Blueprint configuration shows how to define a new **karaf** realm using the public key login module, where the default **karaf** realm is overridden by setting the **rank** attribute to **200**:

```
<?xml version="1.0" encoding="UTF-8"?>
<blueprint xmlns="http://www.osgi.org/xmlns/blueprint/v1.0.0"
  xmlns:jaas="http://karaf.apache.org/xmlns/jaas/v1.0.0"
  xmlns:cm="http://aries.apache.org/blueprint/xmlns/blueprint-
cm/v1.1.0"
  xmlns:ext="http://aries.apache.org/blueprint/xmlns/blueprint-
ext/v1.0.0">

  <!-- Allow usage of System properties, especially the karaf.base
property -->
  <ext:property-placeholder placeholder-prefix="$[" placeholder-
suffix="]"/>

  <jaas:config name="karaf" rank="200">
    <jaas:module
className="org.apache.karaf.jaas.modules.publickey.PublickeyLoginModule"
      flags="required">
      users = $[karaf.base]/etc/keys.properties
    </jaas:module>
  </jaas:config>

</blueprint>
```

In this example, the user data will be stored in the file, **InstallDir/etc/keys.properties**, and it is not possible to edit the configuration using the `jaas: *` console commands.

### 2.1.6. JAAS JDBC Login Module

## Overview

The JAAS JDBC login module enables you to store user data in a database back-end, using Java Database Connectivity (JDBC) to connect to the database. Hence, you can use any database that supports JDBC to store your user data. To manage the user data, you can use either the native database client tools or the `jaas:*` console commands (where the backing engine uses configured SQL queries to perform the relevant database updates).



### NOTE

User groups are *not* supported in the JAAS JDBC login module.

## Supported credentials

The JAAS JDBC Login Module authenticates username/password credentials, returning the list of roles associated with the authenticated user.

## Implementation classes

The following classes implement the JAAS JDBC Login Module:

### `org.apache.karaf.jaas.modules.jdbc.JDBCLoginModule`

Implements the JAAS login module.

### `org.apache.karaf.jaas.modules.jdbc.JDBCBackingEngineFactory`

Must be exposed as an OSGi service. This service makes it possible for you to manage the user data using the `jaas:*` console commands from the Apache Karaf shell (see [chapter "JAAS Console Commands"](#) in "[Console Reference](#)").

## Options

The JAAS JDBC login module supports the following options:

### `datasource`

The JDBC data source, specified either as an OSGi service or as a JNDI name. You can specify a data source's OSGi service using the following syntax:

```
osgi:ServiceInterfaceName[/ServicePropertiesFilter]
```

The `ServiceInterfaceName` is the interface or class that is exported by the data source's OSGi service (usually `javax.sql.DataSource`).

Because multiple data sources can be exported as OSGi services in a container, it is usually necessary to specify a filter, `ServicePropertiesFilter`, to select the particular data source that you want. Filters on OSGi services are applied to the service property settings and follow a syntax that is borrowed from LDAP filter syntax.

### `query.password`

The SQL query that retrieves the user's password. The query can contain a single question mark character, `?`, which is substituted by the username at run time.



**query.role**

The SQL query that retrieves the user's roles. The query can contain a single question mark character, `?`, which is substituted by the username at run time.

**insert.user**

The SQL query that creates a new user entry. The query can contain two question marks, `?`, characters: the first question mark is substituted by the username and the second question mark is substituted by the password at run time.

**insert.role**

The SQL query that adds a role to a user entry. The query can contain two question marks, `?`, characters: the first question mark is substituted by the username and the second question mark is substituted by the role at run time.

**delete.user**

The SQL query that deletes a user entry. The query can contain a single question mark character, `?`, which is substituted by the username at run time.

**delete.role**

The SQL query that deletes a role from a user entry. The query can contain two question marks, `?`, characters: the first question mark is substituted by the username and the second question mark is substituted by the role at run time.

**delete.roles**

The SQL query that deletes multiple roles from a user entry. The query can contain a single question mark character, `?`, which is substituted by the username at run time.

**Example of setting up a JDBC login module**

To set up a JDBC login module, perform the following main steps:

1. [the section called "Create the database tables"](#)
2. [the section called "Create the data source"](#)
3. [the section called "Specify the data source as an OSGi service"](#)

**Create the database tables**

Before you can set up the JDBC login module, you must set up a users table and a roles table in the backing database to store the user data. For example, the following SQL commands show how to create a suitable **users** table and **roles** table:

```
CREATE TABLE users (
  username varchar(255) NOT NULL,
  password varchar(255) NOT NULL,
  PRIMARY KEY (username)
);
CREATE TABLE roles (
  username varchar(255) NOT NULL,
```

```

    role varchar(255) NOT NULL,
    PRIMARY KEY (username,role)
);

```

The **users** table stores username/password data and the **roles** table associates a username with one or more roles.

## Create the data source

To use a JDBC datasource with the JDBC login module, the correct approach to take is to create a data source instance and export the data source as an OSGi service. The JDBC login module can then access the data source by referencing the exported OSGi service. For example, you could create a MySQL data source instance and expose it as an OSGi service (of `javax.sql.DataSource` type) using code like the following in a Blueprint file:

```

<blueprint xmlns:xsi="http://www.w3.org/2001/XMLSchema-instance"
  xmlns="http://www.osgi.org/xmlns/blueprint/v1.0.0">
  <bean class="com.mysql.jdbc.jdbc2.optional.MysqlDataSource"
  id="mysqlDataSource">
    <property name="serverName" value="localhost"></property>
    <property name="databaseName" value="DBName"></property>
    <property name="port" value="3306"></property>
    <property name="user" value="DBUser"></property>
    <property name="password" value="DBPassword"></property>
  </bean>

  <service id="mysqlDS" interface="javax.sql.DataSource"
  ref="mysqlDataSource">
    <service-properties>
      <entry key="osgi.jndi.service.name" value="jdbc/karafdb"/>
    </service-properties>
  </service>
</blueprint>

```

The preceding Blueprint configuration should be packaged and installed in the container as an OSGi bundle.

## Specify the data source as an OSGi service

After the data source has been instantiated and exported as an OSGi service, you are ready to configure the JDBC login module. In particular, the **datasource** option of the JDBC login module can reference the data source's OSGi service using the following syntax:

```
osgi:javax.sql.DataSource/(osgi.jndi.service.name=jdbc/karafdb)
```

Where `javax.sql.DataSource` is the interface type of the exported OSGi service and the filter, `(osgi.jndi.service.name=jdbc/karafdb)`, selects the particular `javax.sql.DataSource` instance whose `osgi.jndi.service.name` service property has the value, `jdbc/karafdb`.

For example, you can use the following Blueprint configuration to override the **karaf** realm with a JDBC login module that references the sample MySQL data source:

```

<?xml version="1.0" encoding="UTF-8"?>
<blueprint xmlns="http://www.osgi.org/xmlns/blueprint/v1.0.0"

```

```

xmlns:jaas="http://karaf.apache.org/xmlns/jaas/v1.0.0"
xmlns:cm="http://aries.apache.org/blueprint/xmlns/blueprint-
cm/v1.1.0"
xmlns:ext="http://aries.apache.org/blueprint/xmlns/blueprint-
ext/v1.0.0">

    <!-- Allow usage of System properties, especially the karaf.base
property -->
    <ext:property-placeholder placeholder-prefix="$[" placeholder-
suffix="]"/>

    <jaas:config name="karaf" rank="200">
        <jaas:module
className="org.apache.karaf.jaas.modules.jdbc.JDBCLoginModule"
            flags="required">
            datasource =
osgi:javax.sql.DataSource/(osgi.jndi.service.name=jdbc/karafdb)
            query.password = SELECT PASSWORD FROM USERS WHERE USERNAME=?
            query.role = SELECT ROLE FROM ROLES WHERE USERNAME=?
            insert.user = INSERT INTO USERS VALUES(?,?)
            insert.role = INSERT INTO ROLES VALUES(?,?)
            delete.user = DELETE FROM USERS WHERE USERNAME=?
            delete.role = DELETE FROM ROLES WHERE USERNAME=? AND ROLE=?
            delete.roles = DELETE FROM ROLES WHERE USERNAME=?
        </jaas:module>
    </jaas:config>

    <!-- The Backing Engine Factory Service for the JDBCLoginModule -->
    <service
interface="org.apache.karaf.jaas.modules.BackingEngineFactory">
        <bean
class="org.apache.karaf.jaas.modules.jdbc.JDBCBackingEngineFactory"/>
    </service>

</blueprint>

```



## NOTE

The SQL statements shown in the preceding configuration are in fact the default values of these options. Hence, if you create user and role tables consistent with these SQL statements, you could omit the options settings and rely on the defaults.

In addition to creating a `JDBCLoginModule`, the preceding Blueprint configuration also instantiates and exports a `JDBCBackingEngineFactory` instance, which enables you to manage the user data using the `jaas:*` console commands.

## 2.1.7. JAAS LDAP Login Module

### Overview

The JAAS LDAP login module enables you to store user data in an LDAP database. To manage the stored user data, use a standard LDAP client tool. The `jaas:*` console commands are *not* supported.

For more details about using LDAP with Red Hat JBoss Fuse see [Chapter 7, LDAP Authentication Tutorial](#).

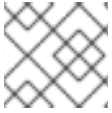

## NOTE

User groups are *not* supported in the JAAS LDAP login module.

## Supported credentials

The JAAS LDAP Login Module authenticates username/password credentials, returning the list of roles associated with the authenticated user.

## Implementation classes

The following classes implement the JAAS LDAP Login Module:

### `org.apache.karaf.jaas.modules.ldap.LDAPLoginModule`

Implements the JAAS login module. It is preloaded in the container, so you do not need to install its bundle.



## NOTE

There is no backing engine factory for the LDAP Login Module, which means that this module cannot be managed using the `jaas:*` console commands.

## Options

The JAAS LDAP login module supports the following options:

### `connection.url`

Specifies specify the location of the directory server using an ldap URL, `ldap://Host:Port`. You can optionally qualify this URL, by adding a forward slash, `/`, followed by the DN of a particular node in the directory tree.

### `connection.username`

Specifies the DN of the user that opens the connection to the directory server. For example, `uid=admin,ou=system`.

### `connection.password`

Specifies the password that matches the DN from `connection.username`. In the directory server, the password is normally stored as a `userPassword` attribute in the corresponding directory entry.

### `authentication`

Specifies the authentication method used when binding to the LDAP server. Valid values are

- **simple**—bind with user name and password authentication, requiring you to set the `connection.username` and `connection.password` properties.
- **none**—bind anonymously. In this case the `connection.username` and `connection.password` properties can be left unassigned.

**NOTE**

The connection to the directory server is used only for performing searches. In this case, an anonymous bind is often preferred, because it is faster than an authenticated bind (but you would also need to ensure that the directory server is sufficiently protected, for example by deploying it behind a firewall).

**user.base.dn**

Specifies the DN of the subtree of the DIT to search for user entries. For example, **ou=users,ou=system**.

**user.filter**

Specifies the LDAP search filter used to locate user credentials. It is applied to the subtree selected by **user.base.dn**. For example, **(uid=%u)**. Before being passed to the LDAP search operation, the value is subjected to string substitution, as follows:

- **%u** is replaced by the user name extracted from the incoming credentials.

**user.search.subtree**

Specifies whether the user entry search scope includes the subtrees of the tree selected by **user.base.dn**. If **true**, the user lookup is recursive (**SUBTREE**). If **false**, the user lookup is performed only at the first level (**ONELEVEL**).

**role.base.dn**

Specifies the DN of the subtree of the DIT to search for role entries. For example, **ou=groups,ou=system**.

**role.filter**

Specifies the LDAP search filter used to locate roles. It is applied to the subtree selected by **role.base.dn**. For example, **(member=uid=%u)**. Before being passed to the LDAP search operation, the value is subjected to string substitution, as follows:

- **%u** is replaced by the user name extracted from the incoming credentials, and
- **%dn** is replaced by the RDN of the corresponding user in the LDAP server (which was found by matching against the **user.filter** filter).
- **%fqdn** is replaced by the DN of the corresponding user in the LDAP server (which was found by matching against the **user.filter** filter).

**role.name.attribute**

Specifies the attribute type of the role entry that contains the name of the role/group. If you omit this option, the role search feature is effectively disabled. For example, **cn**.

**role.search.subtree**

Specifies whether the role entry search scope includes the subtrees of the tree selected by **role.base.dn**. If **true**, the role lookup is recursive (**SUBTREE**). If **false**, the role lookup is performed only at the first level (**ONELEVEL**).

**initial.context.factory**

Specifies the class of the context factory used to connect to the LDAP server. This must always be set to **com.sun.jndi.ldap.LdapCtxFactory**.

## ssl

Specifies whether the connection to the LDAP server is secured using SSL. If `connection.url` starts with `ldaps://` SSL is used regardless of this property.

### ssl.provider

Specifies the SSL provider to use for the LDAP connection. If not specified, the default SSL provider is used.

### ssl.protocol

Specifies the protocol to use for the SSL connection. You *must* set this property to **TLSv1**, in order to prevent the SSLv3 protocol from being used (POODLE vulnerability).

### ssl.algorithm

Specifies the algorithm used by the trust store manager. For example, **PKIX**.

### ssl.keystore

The ID of the keystore that stores the LDAP client's own X.509 certificate (required only if SSL client authentication is enabled on the LDAP server). The keystore must be deployed using a **jaas:keystore** element (see [the section called "Sample configuration for Apache DS"](#)).

### ssl.keyalias

The keystore alias of the LDAP client's own X.509 certificate (required only if there is more than one certificate stored in the keystore specified by **ssl.keystore**).

### ssl.truststore

The ID of the keystore that stores trusted CA certificates, which are used to verify the LDAP server's certificate (the LDAP server's certificate chain must be signed by one of the certificates in the truststore). The keystore must be deployed using a **jaas:keystore** element.

## Sample configuration for Apache DS

The following Blueprint configuration shows how to define a new **karaf** realm using the LDAP login module, where the default **karaf** realm is overridden by setting the **rank** attribute to **200**, and the LDAP login module connects to an Apache Directory Server:

```
<?xml version="1.0" encoding="UTF-8"?>
<blueprint xmlns="http://www.osgi.org/xmlns/blueprint/v1.0.0"
  xmlns:jaas="http://karaf.apache.org/xmlns/jaas/v1.0.0"
  xmlns:cm="http://aries.apache.org/blueprint/xmlns/blueprint-
cm/v1.1.0"
  xmlns:ext="http://aries.apache.org/blueprint/xmlns/blueprint-
ext/v1.0.0">

  <!-- Allow usage of System properties, for example the karaf.home
property -->
  <ext:property-placeholder placeholder-prefix="${" placeholder-
```

```

suffix="}"/>

    <jaas:config name="karaf" rank="200">
      <jaas:module
class="org.apache.karaf.jaas.modules.ldap.LDAPLoginModule"
      <flags="required">
        initialContextFactory=com.sun.jndi.ldap.LdapCtxFactory
        connection.username=uid=admin,ou=system
        connection.password=secret
        connection.protocol=
        connection.url=ldap://localhost:10389
        user.base.dn=ou=users,ou=system
        user.filter=(uid=%u)
        user.search.subtree=true
        role.base.dn=ou=roles,ou=system
        role.name.attribute=cn
        role.filter=(member=uid=%u)
        role.search.subtree=true
        authentication=simple
        ssl.protocol=TLSv1
        ssl.truststore=ks
        ssl.algorithm=PKIX
      </jaas:module>
    </jaas:config>

    <jaas:keystore name="ks"
      path="file:///${karaf.home}/etc/trusted.ks"
      keystorePassword="secret" />

</blueprint>

```



### IMPORTANT

You must set **ssl.protocol** to **TLSv1**, in order to protect against the [Poodle vulnerability \(CVE-2014-3566\)](#)

### Filter settings for different directory servers

The most significant differences between directory servers arise in connection with setting the filter options in the LDAP login module. The precise settings depend ultimately on the organisation of your DIT, but the following table gives an idea of the typical role filter settings required for different directory servers:

Directory Server	Typical Filter Settings
389-DS Red Hat DS	<pre> user.filter=(&amp; (objectClass=InetOrgPerson) (uid=%u)) role.filter=(uniquemember=%fqdn) </pre>

Directory Server	Typical Filter Settings
MS Active Directory	<pre>user.filter=(&amp; (objectCategory=person) (samAccountName=%u)) role.filter=(uniquemember=%fqdn)</pre>
Apache DS	<pre>user.filter=(uid=%u) role.filter=(member=uid=%u)</pre>
OpenLDAP	<pre>user.filter=(uid=%u) role.filter=(member:=uid=%u)</pre>



#### NOTE

In the preceding table, the `&` symbol (representing the logical *And* operator) is escaped as `&amp;`; because the option settings will be embedded in a Blueprint XML file.

## 2.1.8. Encrypting Stored Passwords

### Overview

By default, the JAAS login modules store passwords in plaintext format. Although you can (and should) protect such data by setting file permissions appropriately, you can provide additional protection to passwords by storing them in an obscured format (using a *message digest* algorithm).

Red Hat JBoss Fuse provides a set of options for enabling password encryption, which can be combined with *any* of the JAAS login modules (except the public key login module, where it is not needed).



#### IMPORTANT

Although message digest algorithms are difficult to crack, they are not invulnerable to attack (for example, see the [Wikipedia article on cryptographic hash functions](#)). Always use file permissions to protect files containing passwords, in addition to using password encryption.

### Options

You can optionally enable password encryption for JAAS login modules by setting the following login module properties. To do so, either edit the `InstallDir/etc/org.apache.karaf.jaas.cfg` file or deploy your own blueprint file as described in [the section called “Example of a login module with Jasypt encryption”](#).

#### `encryption.enabled`

Set to `true`, to enable password encryption.



**encryption.name**

Name of the encryption service, which has been registered as an OSGi service.

**encryption.prefix**

Prefix for encrypted passwords.

**encryption.suffix**

Suffix for encrypted passwords.

**encryption.algorithm**

Specifies the name of the encryption algorithm—for example, **MD5** or **SHA-1**. You can specify one of the following encryption algorithms:

- **MD2**
- **MD5**
- **SHA-1**
- **SHA-256**
- **SHA-384**
- **SHA-512**

**encryption.encoding**

Encrypted passwords encoding: **hexadecimal** or **base64**.

**encryption.providerName** (*Jasypt only*)

Name of the **java.security.Provider** instance that is to provide the digest algorithm.

**encryption.providerClassName** (*Jasypt only*)

Class name of the security provider that is to provide the digest algorithm

**encryption.iterations** (*Jasypt only*)

Number of times to apply the hash function recursively.

**encryption.saltSizeBytes** (*Jasypt only*)

Size of the salt used to compute the digest.

**encryption.saltGeneratorClassName** (*Jasypt only*)

Class name of the salt generator.

**role.policy**

Specifies the policy for identifying role principals. Can have the values, **prefix** or **group**.

**role.discriminator**

Specifies the discriminator value to be used by the role policy.

## Encryption services

There are two encryption services provided by JBoss Fuse:

- `encryption.name = basic`, described in [the section called “Basic encryption service”](#),
- `encryption.name = jasypt`, described in [the section called “Jasypt encryption”](#).

You can also create your own encryption service. To do so, you need to:

- implement interface `org.apache.karaf.jaas.modules.EncryptionService`
- and expose your implementation as OSGI service.

Following listing shows, how jasypt encryption service is exposed to OSGI container.

```
<blueprint xmlns="http://www.osgi.org/xmlns/blueprint/v1.0.0">
    <service interface="org.apache.karaf.jaas.modules.EncryptionService">
        <service-properties>
            <entry key="name" value="jasypt" />
        </service-properties>
        <bean
class="org.apache.karaf.jaas.jasypt.impl.JasyptEncryptionService"/>
    </service>
    ...
</blueprint>
```

### Basic encryption service

The basic encryption service is installed in the standalone container by default and you can reference it by setting the `encryption.name` property to the value, `basic`. In the basic encryption service, the message digest algorithms are provided by the [SUN](#) security provider (the default security provider in the Oracle JDK).

### Jasypt encryption

By default, the Jasypt encryption service is installed on standalone JBoss Fuse, but not on standalone JBoss A-MQ. To install it on JBoss A-MQ, install the `jasypt-encryption` feature, using the following console command:

```
JBossA-MQ:karaf@root> features:install jasypt-encryption
```

This command installs the requisite Jasypt bundles and exports Jasypt encryption as an OSGi service, so that it is available for use by JAAS login modules. To access the Jasypt encryption service, set the `encryption.name` property to the value, `jasypt`.

For more information about Jasypt encryption, see the [Jasypt documentation](#).

### Example of a login module with Jasypt encryption

Assuming that you have already installed the `jasypt-encryption` feature, you could deploy a properties login module with Jasypt encryption using the following Blueprint configuration:

```
<?xml version="1.0" encoding="UTF-8"?>
```

```

<blueprint xmlns="http://www.osgi.org/xmlns/blueprint/v1.0.0"
           xmlns:jaas="http://karaf.apache.org/xmlns/jaas/v1.0.0"
           xmlns:cm="http://aries.apache.org/blueprint/xmlns/blueprint-
cm/v1.1.0"
           xmlns:ext="http://aries.apache.org/blueprint/xmlns/blueprint-
ext/v1.0.0">

    <type-converters>
        <bean
class="org.apache.karaf.jaas.modules.properties.PropertiesConverter"/>
    </type-converters>

    <!-- Allow usage of System properties, especially the karaf.base
property -->
    <ext:property-placeholder placeholder-prefix="$[" placeholder-
suffix="]"/>

    <jaas:config name="karaf" rank="200">
        <jaas:module
className="org.apache.karaf.jaas.modules.properties.PropertiesLoginModule"
            flags="required">
            users = $[karaf.base]/etc/users.properties
            encryption.enabled = true
            encryption.name = jasypt
            encryption.algorithm = SHA-256
            encryption.encoding = base64
            encryption.iterations = 100000
            encryption.saltSizeBytes = 16
        </jaas:module>
    </jaas:config>

    <!-- The Backing Engine Factory Service for the PropertiesLoginModule
-->
    <service
interface="org.apache.karaf.jaas.modules.BackingEngineFactory">
        <bean
class="org.apache.karaf.jaas.modules.properties.PropertiesBackingEngineFac
tory"/>
    </service>

    <!-- Enable automatic encryption of all user passwords in
InstallDir/etc/users.properties
file - no login required to activate. Encrypted passwords appear in
the
InstallDir/etc/users.properties file as values enclosed by {CRYPT}...
{CRYPT}
prefix/suffix pairs -->

    <bean
class="org.apache.karaf.jaas.modules.properties.AutoEncryptionSupport"
        init-method="init" destroy-method="destroy">
        <argument>
            <map>
                <entry key="org.osgi.framework.BundleContext" value-
ref="blueprintBundleContext"/>
                <entry key="users"

```

```
value="$[karaf.base]/etc/users.properties"/>
    <entry key="encryption.name" value="jasypt"/>
    <entry key="encryption.enabled" value="true"/>
    <entry key="encryption.prefix" value="{CRYPT}"/>
    <entry key="encryption.suffix" value="{CRYPT}"/>
    <entry key="encryption.algorithm" value="SHA-256"/>
    <entry key="encryption.encoding" value="base64"/>
    <entry key="encryption.iterations" value="100000"/>
    <entry key="encryption.saltSizeBytes" value="16"/>
    </map>
</argument>
</bean>

</blueprint>
```

## 2.2. ROLE-BASED ACCESS CONTROL

### Abstract

This section describes the role-based access control (RBAC) feature, which is enabled by default in the JBoss Fuse container. You can immediately start taking advantage of the RBAC feature, simply by adding one of the standard roles (such as **Deployer** or **Administrator**) to a user's credentials. For more advanced usage, you have the option of customizing the access control lists, in order to control exactly what each role can do. Finally, you have the option of applying custom ACLs to your own OSGi services.

### 2.2.1. Overview of Role-Based Access Control

#### Overview

By default, the JBoss Fuse role-based access control protects access through the Fuse Management Console, JMX connections, and the Karaf command console. To use the default levels of access control, simply add any of the standard roles to your user authentication data (for example, by editing the **users.properties** file). You also have the option of customizing access control, by editing the relevant Access Control List (ACL) files.

#### Mechanisms

Role-based access control in JBoss Fuse is based on the following mechanisms:

##### JMX Guard

The JBoss Fuse container is configured with a JMX guard, which intercepts every incoming JMX invocation and filters the invocation through the configured JMX access control lists. The JMX guard is configured at the JVM level, so it intercepts every JMX invocation, without exception.

##### OSGi Service Guard

For any OSGi service, it is possible to configure an OSGi service guard. The OSGi service guard is implemented as a proxy object, which interposes itself between the client and the original OSGi service. An OSGi service guard must be explicitly configured for each OSGi service: it is not installed by default (except for the OSGi services that represent Karaf console commands, which are preconfigured for you).

## Types of protection

The JBoss Fuse implementation of role-based access control is capable of providing the following types of protection:

### Fuse Management Console (Hawtio)

Container access through the Fuse Management Console (Hawtio) is controlled by the JMX ACL files. The REST/HTTP service that provides the Fuse Management Console is implemented using Jolokia technology, which is layered above JMX. Hence, ultimately, all Fuse Management Console invocations pass through JMX and are regulated by JMX ACLs.

### JMX

Direct access to the container's JMX port is regulated by the JMX ACLs. Moreover, any additional JMX ports opened by an application running in the container would also be regulated by the JMX ACLs, because the JMX guard is set at the JVM level.

### Karaf command console

Access to the Karaf command console is regulated by the command console ACL files. Access control is applied no matter how the Karaf console is accessed. Whether accessing the command console through the Fuse Management Console or through the SSH protocol, access control is applied in both cases.



#### NOTE

In the special case where you start up the container directly at the command line (for example, using the `./bin/fuse` script) and no user authentication is performed, you automatically get the roles specified by the `karaf.local.roles` property in the `etc/system.properties` file.

### OSGi services

For any OSGi service deployed in the container, you can optionally enable an ACL file, which restricts method invocations to specific roles.

## Adding roles to users

In the system of role-based access control, you can give users permissions by adding roles to their user authentication data. For example, the following entry in the `etc/users.properties` file defines the `admin` user and grants the `Administrator` and `SuperUser` roles.

```
admin = secretpass,Administrator,SuperUser
```

You also have the option of defining user groups and then assigning users to a particular user group. For example, you could define and use an `admingroup` user group as follows:

```
admin = secretpass, _g_:admingroup
_g_\:admingroup = Administrator, SuperUser
```

**NOTE**

User groups are not supported by every type of JAAS login module.

**Standard roles**

Table 2.2, “Standard Roles for Access Control” lists and describes the standard roles that are used throughout the JMX ACLs and the command console ACLs.

**Table 2.2. Standard Roles for Access Control**

Roles	Description
<b>Monitor, Operator, Maintainer</b>	Grants read-only access to the container.
<b>Deployer, Auditor</b>	Grants read-write access at the appropriate level for ordinary users, who want to deploy and run applications. But blocks access to sensitive container configuration settings.
<b>Administrator, SuperUser</b>	Grants unrestricted access to the container.

**ACL files**

The standard set of ACL files are located under the **etc/auth/** directory of the JBoss Fuse installation, as follows:

**etc/auth/jmx.ac1[.\*].cfg**

JMX ACL files.

**etc/auth/org.apache.karaf.command.ac1.\*.cfg**

Command console ACL files.

**Customizing role-based access control**

A complete set of JMX ACL files and command console ACL files are provided by default. You are free to customize these ACLs as required to suit the requirements of your system. Details of how to do this are given in the following sections.

**Additional properties for controlling access**

The **system.properties** file under the **etc** directory provides the following additional properties for controlling access through the Karaf command console and the Fuse Management Console (Hawtio):

**karaf.local.roles**

Specifies the roles that apply when a user starts up the container console *locally* (for example, by running the **./bin/fuse** script).

**hawtio.roles**

Specifies the roles that are allowed to access the container through the Fuse Management Console. This constraint is applied *in addition to* the access control defined by the JMX ACL files.

## 2.2.2. Customizing the JMX ACLs

### Overview

The JMX ACLs are stored in the OSGi Config Admin Service and are normally accessible as the files, `etc/auth/jmx.ac1.*.cfg`. This section explains how you can customize the JMX ACLs by editing these files yourself.

### Architecture

Figure 2.1, “Access Control Mechanism for JMX” shows an overview of the role-based access control mechanism for JMX connections to the JBoss Fuse container.

Figure 2.1. Access Control Mechanism for JMX

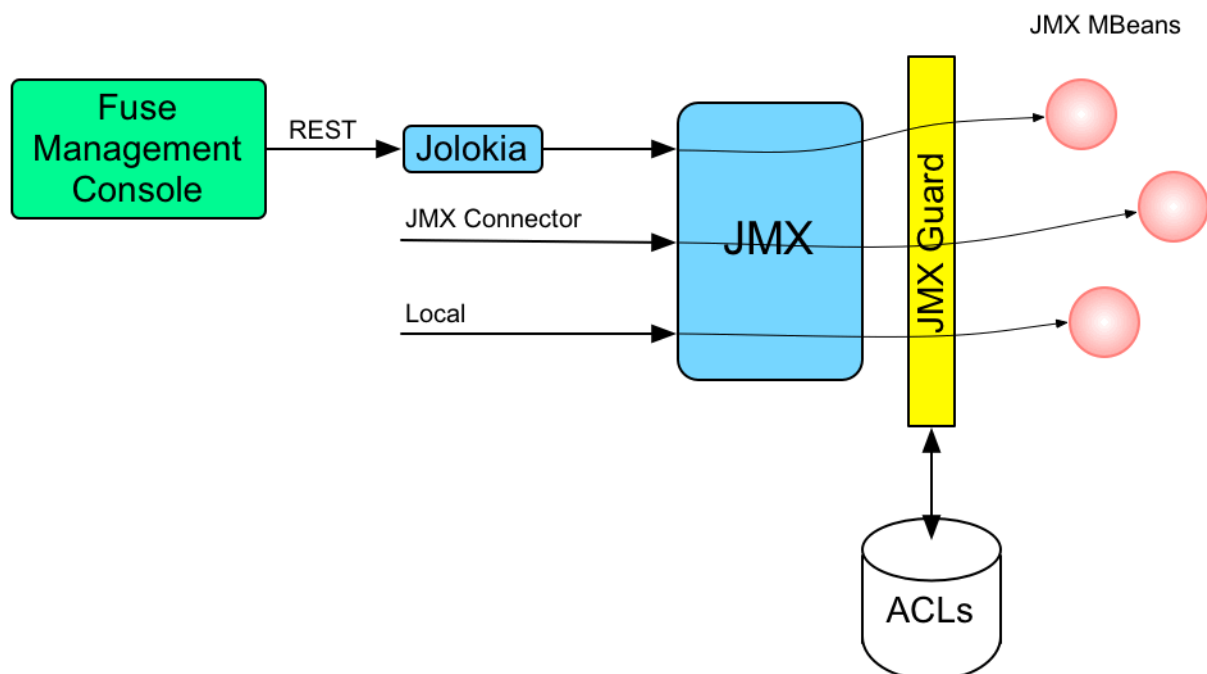

### How it works

JMX access control works by inserting a *JMX Guard*, which is configured through a JVM-wide **MBeanServerBuilder** object. The Apache Karaf launching scripts have been modified to include the following setting:

```
-
Djavax.management.builder.initial=org.apache.karaf.management.boot.KarafMBeanServerBuilder
```

JMX access control is now applied as follows:

1. For every incoming JMX invocation, the JVM-wide **MBeanServerBuilder** calls into an OSGi bundle that contains the JMX Guard.

2. The JMX Guard looks up the relevant ACL for the MBean the user is trying to access (where the ACLs are stored in the OSGi Config Admin service).
3. The ACL returns the list of roles that are allowed to make this particular invocation on the MBean.
4. The JMX Guard checks the list of roles against the current security subject (the user that is making the JMX invocation), to see whether the current user has any of the required roles.
5. If no matching role is found, the JMX invocation is blocked and a **SecurityException** is raised.

## Location of JMX ACL files

The JMX ACL files are located in the ***InstallDir/etc/auth*** directory, where the ACL file names obey the following convention:

```
etc/auth/jmx.acl[.*].cfg
```

Technically, the ACLs are mapped to OSGi persistent IDs (PIDs), matching the pattern, ***jmx.acl[.\*]***. It just so happens that the standalone container stores OSGi PIDs as files, ***PID.cfg***, under the ***etc/*** directory by default.

## Mapping MBeans to ACL file names

The JMX Guard applies access control to *every* MBean class that is accessed through JMX (including any MBeans you define in your own application code). The ACL file for a specific MBean class is derived from the MBean's Object Name, by prefixing it with ***jmx.acl***. For example, given the MBean whose Object Name is given by ***org.apache.activemq:type=Broker***, the corresponding PID would be:

```
jmx.acl.org.apache.activemq.Broker
```

In the case of a standalone container, the OSGi Config Admin service stores this PID data in the following file:

```
etc/auth/jmx.acl.org.apache.activemq.Broker.cfg
```

## ACL file format

Each line of a JMX ACL file is an entry in the following format:

```
Pattern = Role1[,Role2][,Role3]. . .
```

Where ***Pattern*** is a pattern that matches a method invocation on an MBean, and the right-hand side of the equals sign is a comma-separated list of roles that give a user permission to make that invocation. In the simplest cases, the ***Pattern*** is simply a method name. For example, as in the following settings for the ***org.apache.activemq.Broker*** MBean (from the ***jmx.acl.org.apache.activemq.Broker.cfg*** file):

```
addConnector = Deployer, Auditor, Administrator, SuperUser
removeConnector = Deployer, Auditor, Administrator, SuperUser
enableStatistics = Deployer, Auditor, Administrator, SuperUser
addNetworkConnector = Deployer, Auditor, Administrator, SuperUser
```



It is also possible to use the wildcard character, `*`, to match multiple method names. For example, the following entry gives permission to invoke all method names starting with `set`:

```
set* = Deployer, Auditor, Administrator, SuperUser
```

But the ACL syntax is also capable of defining much more fine-grained control of method invocations. You can define patterns to match methods invoked with specific arguments or even arguments that match a regular expression. For example, the ACL for the `org.apache.karaf.config` MBean package exploits this capability to prevent ordinary users from modifying sensitive configuration settings. The `create` method from this package is restricted, as follows:

```
create(java.lang.String)[/jmx[.]acl.*/] = Administrator, SuperUser
create(java.lang.String)[/org[.]apache[.]karaf[.]command[.]acl.+/] =
Administrator, SuperUser
create(java.lang.String)[/org[.]apache[.]karaf[.]service[.]acl.+/] =
Administrator, SuperUser
create(java.lang.String) = Deployer, Auditor, Administrator, SuperUser
```

In this case, the `Deployer` and `Auditor` roles generally have permission to invoke the `create` method, but only the `Administrator` and `SuperUser` roles have permission to invoke `create` with a PID argument matching `jmx.acl.*`, `org.apache.karaf.command.acl.*`, or `org.apache.karaf.service.*`.

For complete details of the ACL file format, please see the comments in the `etc/auth/jmx.acl.cfg` file.

## ACL file hierarchy

Because it is often impractical to provide an ACL file for every single MBean, you have the option of specifying an ACL file at the level of a Java package, which provides default settings for *all* of the MBeans in that package. For example, the `org.apache.activemq.Broker` MBean could be affected by ACL settings at *any* of the following PID levels:

```
jmx.acl.org.apache.activemq.Broker
jmx.acl.org.apache.activemq
jmx.acl.org.apache
jmx.acl.org
jmx.acl
```

Where the most specific PID (top of the list) takes precedence over the least specific PID (bottom of the list).

## Root ACL definitions

The root ACL file, `jmx.acl.cfg`, is a special case, because it supplies the default ACL settings for *all* MBeans. The root ACL has the following settings by default:

```
list* = viewer, Monitor, Operator, Maintainer, Deployer, Auditor,
Administrator, SuperUser
get* = viewer, Monitor, Operator, Maintainer, Deployer, Auditor,
Administrator, SuperUser
is* = viewer, Monitor, Operator, Maintainer, Deployer, Auditor,
```

```
Administrator, SuperUser
set* = admin, Administrator, SuperUser
* = admin, Administrator, SuperUser
```

This implies that the typical *read* method patterns (**list\***, **get\***, **is\***) are accessible to all standard roles, but the typical *write* method patterns and other methods (**set\*** and **\***) are accessible only to the administrator roles, **admin**, **Administrator**, **SuperUser**.

## Package ACL definitions

Many of the standard JMX ACL files provided in **etc/auth/jmx.acl[.\*].cfg** apply to MBean packages. For example, the ACL for the **org.apache.camel.endpoints** MBean package is defined with the following permissions:

```
is* = Monitor, Operator, Maintainer, Deployer, Auditor, Administrator,
SuperUser
get* = Monitor, Operator, Maintainer, Deployer, Auditor, Administrator,
SuperUser
set* = Deployer, Auditor, Administrator, SuperUser
```

## ACL for custom MBeans

If you define custom MBeans in your own application, these custom MBeans are automatically integrated with the ACL mechanism and protected by the JMX Guard when you deploy them into the container. By default, however, your MBeans are typically protected only by the default root ACL file, **jmx.acl.cfg**. If you want to define a more fine-grained ACL for your MBean, create a new ACL file under **etc/auth**, using the standard JMX ACL file naming convention.

For example, if your custom MBean class has the JMX Object Name, **org.example:type=MyMBean**, create a new ACL file under the **etc/auth** directory called:

```
jmx.acl.org.example.MyMBean.cfg
```

## Dynamic configuration at run time

Because the OSGi Config Admin service is dynamic, you can change ACL settings while the system is running, and even while a particular user is logged on. Hence, if you discover a security breach while the system is running, you can immediately restrict access to certain parts of the system by editing the relevant ACL file, without having to restart the container.

### 2.2.3. Customizing the Command Console ACLs

#### Overview

The command console ACLs are stored in the OSGi Config Admin Service and are normally accessible as the files, **etc/auth/org.apache.karaf.command.acl.\*.cfg**. This section explains how you can customize the command console ACLs by editing these files yourself.

#### Architecture

[Figure 2.2, “Access Control Mechanism for OSGi Services”](#) shows an overview of the role-based access control mechanism for OSGi services in the JBoss Fuse container.

Figure 2.2. Access Control Mechanism for OSGi Services

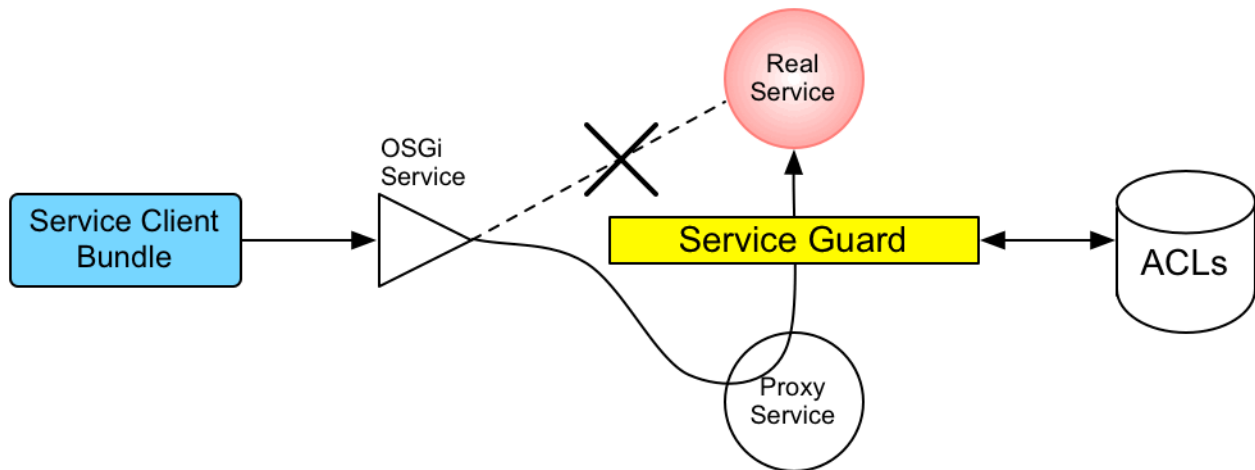

### How it works

The mechanism for command console access control is, in fact, based on the generic access control mechanism for OSGi services. It so happens that console commands are implemented and exposed as OSGi services. The Karaf console itself discovers the available commands through the OSGi service registry and accesses the commands as OSGi services. Hence, the access control mechanism for OSGi services can be used to control access to console commands.

The mechanism for securing OSGi services is based on OSGi Service Registry Hooks. This is an advanced OSGi feature that makes it possible to hide OSGi services from certain consumers and to replace an OSGi service with a proxy service.

When a service guard is in place for a particular OSGi service, a client invocation on the OSGi service proceeds as follows:

1. The invocation does *not* go directly to the requested OSGi service. Instead, the request is routed to a replacement proxy service, which has the same service properties as the original service (and some extra ones).
2. The service guard looks up the relevant ACL for the target OSGi service (where the ACLs are stored in the OSGi Config Admin service).
3. The ACL returns the list of roles that are allowed to make this particular method invocation on the service.
4. The service guard checks the list of roles against the current security subject (the user that is making the method invocation), to see whether the current user has any of the required roles.
5. If no matching role is found, the method invocation is blocked and a **SecurityException** is raised.
6. Alternatively, if a matching role is found, the method invocation is delegated to the original OSGi service.

### Location of command console ACL files

The command console ACL files are located in the `InstallDir/etc/auth` directory, with the prefix, `org.apache.karaf.command.acl`.

### Mapping command scopes to ACL file names

The command console ACL file names obey the following convention:

```
etc/auth/org.apache.karaf.command.acl.CommandScope.cfg
```

Where the **CommandScope** corresponds to the prefix for a particular group of Karaf console commands. For example, the **features:install** and **features:uninstall** commands belong to the **features** command scope, which has the corresponding ACL file, **org.apache.karaf.command.acl.features.cfg**.

## ACL file format

Each line of a command console ACL file is an entry in the following format:

```
Pattern = Role1[,Role2][,Role3]...
```

Where **Pattern** is a pattern that matches a Karaf console command from the current command scope, and the right-hand side of the equals sign is a comma-separated list of roles that give a user permission to make that invocation. In the simplest cases, the **Pattern** is simply an unscoped command name. For example, the **org.apache.karaf.command.acl.features.cfg** ACL file includes the following rules for the **features** commands:

```
list = Monitor, Operator, Maintainer, Deployer, Auditor, Administrator, SuperUser
listRepositories = Monitor, Operator, Maintainer, Deployer, Auditor, Administrator, SuperUser
listUrl = Monitor, Operator, Maintainer, Deployer, Auditor, Administrator, SuperUser
info = Monitor, Operator, Maintainer, Deployer, Auditor, Administrator, SuperUser
install = Administrator, SuperUser
uninstall = Administrator, SuperUser
```

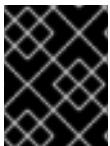

### IMPORTANT

If no match is found for a specific command name, it is assumed that no role is required for this command and it can be invoked by any user.

You can also define patterns to match commands invoked with specific arguments or even arguments that match a regular expression. For example, the **org.apache.karaf.command.acl.osgi.cfg** ACL file exploits this capability to prevent ordinary users from invoking the **osgi:start** and **osgi:stop** commands with the **-f** (force) flag (which must be specified to manage system bundles). This restriction is coded as follows in the ACL file:

```
start[/.*[-][f].*/] = Administrator, SuperUser
start = Deployer, Auditor, Administrator, SuperUser
stop[/.*[-][f].*/] = Administrator, SuperUser
stop = Deployer, Auditor, Administrator, SuperUser
```

In this case, the **Deployer** and **Auditor** roles generally have permission to invoke the **osgi:start** and **osgi:stop** commands, but only the **Administrator** and **SuperUser** roles have permission to invoke these commands with the force option, **-f**.

For complete details of the ACL file format, please see the comments in the `etc/auth/org.apache.karaf.command.acl.osgi.cfg` file.

## Dynamic configuration at run time

The command console ACL settings are fully dynamic, which means you can change the ACL settings while the system is running and the changes will take effect within a few seconds, even for users that are already logged on.

### 2.2.4. Defining ACLs for OSGi Services

#### Overview

It is possible to define a custom ACL for any OSGi service (whether system level or application level). By default, OSGi services do not have access control enabled (with the exception of the OSGi services that expose Karaf console commands, which are pre-configured with command console ACL files). This section explains how to define a custom ACL for an OSGi service and how to invoke methods on that service using a specified role.

#### ACL file format

An OSGi service ACL file has one special entry, which identifies the OSGi service to which this ACL applies, as follows:

```
service.guard = (objectClass=InterfaceName)
```

Where the value of **service.guard** is an LDAP search filter that is applied to the registry of OSGi service properties in order to pick out the matching OSGi service. The simplest type of filter, **(objectClass=*InterfaceName*)**, picks out an OSGi service with the specified Java interface name, ***InterfaceName***.

The remaining entries in the ACL file are of the following form:

```
Pattern = Role1[,Role2][,Role3]. . .
```

Where ***Pattern*** is a pattern that matches a service method, and the right-hand side of the equals sign is a comma-separated list of roles that give a user permission to make that invocation. The syntax of these entries is essentially the same as the entries in a JMX ACL file—see [the section called “ACL file format”](#).

#### How to define an ACL for a custom OSGi service

To define an ACL for a custom OSGi service, perform the following steps:

1. It is customary to define an OSGi service using a Java interface (you could use a regular Java class, but this is not recommended). For example, consider the Java interface, **MyService**, which we intend to expose as an OSGi service:

```
package org.example;

public interface MyService {
    void doit(String s);
}
```

- To expose the Java interface as an OSGi service, you would typically add a **service** element to an OSGi Blueprint XML file (where the Blueprint XML file is typically stored under the **src/main/resources/OSGI-INF/blueprint** directory in a Maven project). For example, assuming that **MyServiceImpl** is the class that implements the **MyService** interface, you could expose the **MyService** OSGi service as follows:

```
<?xml version="1.0" encoding="UTF-8"?>
<blueprint xmlns="http://www.osgi.org/xmlns/blueprint/v1.0.0"
           xmlns:xsi="http://www.w3.org/2001/XMLSchema-instance"
           default-activation="lazy">

  <bean id="myserviceimpl" class="org.example.MyServiceImpl"/>

  <service id="myservice" ref="myserviceimpl"
           interface="org.example.MyService"/>

</blueprint>
```

- To define an ACL for the the OSGi service, you must create an OSGi Config Admin PID with the prefix, **org.apache.karaf.service.acl**.

For example, in the case of a standalone container (where the OSGi Config Admin PIDs are stored as **.cfg** files under the **etc/auth/** directory), you can create the following ACL file for the **MyService** OSGi service:

```
etc/auth/org.apache.karaf.service.acl.myservice.cfg
```



#### NOTE

It does not matter exactly how you name this file, as long as it starts with the required prefix, **org.apache.karaf.service.acl**. The corresponding OSGi service for this ACL file is actually specified by a property setting in this file (as you will see in the next step).

- Specify the contents of the ACL file in a format like the following:

```
service.guard = (objectClass=InterfaceName)
Pattern = Role1[,Role2][,Role3]...
```

The **service.guard** setting specifies the **InterfaceName** of the OSGi service (using the syntax of an LDAP search filter, which is applied to the OSGi service properties). The other entries in the ACL file consist of a method **Pattern**, which associates a matching method to the specified roles. For example, you could define a simple ACL for the **MyService** OSGi service with the following settings in the **org.apache.karaf.service.acl.myservice.cfg** file:

```
service.guard = (objectClass=org.example.MyService)
doit = Deployer, Auditor, Administrator, SuperUser
```

- Finally, in order to enable the ACL for this OSGi service, you must edit the **karaf.secured.services** property in the **etc/system.properties** file. The value of the **karaf.secured.services** property has the syntax of an LDAP search filter (which gets

applied to the OSGi service properties). In general, to enable ACLs for an OSGi service, **ServiceInterface**, you must modify this property as follows:

```
karaf.secured.services=(|(objectClass=ServiceInterface)
(...ExistingPropValue...))
```

For example, to enable the **MyService** OSGi service:

```
karaf.secured.services=(|(objectClass=org.example.MyService)(&
(osgi.command.scope=*)(osgi.command.function=*))
```

## CAUTION

The initial value of the **karaf.secured.services** property has the settings to enable the command console ACLs. If you delete or corrupt these entries, the command console ACLs might stop working.

## How to invoke an OSGi service secured with RBAC

If you are writing Java code to invoke methods on a custom OSGi service (that is, implementing a client of the OSGi service), you must use the Java security API to specify the role you are using to invoke the service. For example, to invoke the **MyService** OSGi service using the **Deployer** role, you could use code like the following:

```
// Java
import javax.security.auth.Subject;
import org.apache.karaf.jaas.boot.principal.RolePrincipal;
// ...
Subject s = new Subject();
s.getPrincipals().add(new RolePrincipal("Deployer"));
Subject.doAs(s, new PrivilegedAction() {
    public Object run() {
        svc.doit("foo"); // invoke the service
    }
})
```

## NOTE

This example uses the Karaf role type, **org.apache.karaf.jaas.boot.principal.RolePrincipal**. If necessary, you could use your own custom role class instead, but in that case you would have to specify your roles using the syntax **className: roleName** in the OSGi service's ACL file.

## How to discover the roles required by an OSGi service

When you are writing code against an OSGi service secured by an ACL, it can sometimes be useful to check what roles are allowed to invoke the service. For this purpose, the proxy service exports an additional OSGi property, **org.apache.karaf.service.guard.roles**. The value of this property is a **java.util.Collection** object, which contains a list of all the roles that could possibly invoke a method on that service.

## 2.3. USING ENCRYPTED PROPERTY PLACEHOLDERS

## Overview

When securing a container it is undesirable to use plain text passwords in configuration files. They create easy to target security holes. One way to avoid this problem is to use encrypted property placeholders when ever possible. This feature is supported both in Blueprint XML files and in Spring XML files.

## How to use encrypted property placeholders

To use encrypted property placeholders in a Blueprint XML file or in a Spring XML file, perform the following steps:

1. [Download and install Jasypt](#), to gain access to the Jasypt `listAlgorithms.sh`, `encrypt.sh` and `decrypt.sh` command-line tools.



### NOTE

When installing the Jasypt command-line tools, don't forget to enable execute permissions on the script files, by running `chmod u+x ScriptName.sh`.

2. Choose a master password and an encryption algorithm. To discover which algorithms are supported in your current Java environment, run the `listAlgorithms.sh` Jasypt command-line tool, as follows:

```
./listAlgorithms.sh
DIGEST ALGORITHMS:  [MD2, MD5, SHA, SHA-256, SHA-384, SHA-512]

PBE ALGORITHMS:    [PBEWITHMD5ANDDES, PBEWITHMD5ANDTRIPLEDES,
PBEWITHSHA1ANDDESEDE, PBEWITHSHA1ANDRC2_40]
```

On Windows platforms, the script is `listAlgorithms.bat`. JBoss Fuse uses `PBEWithMD5AndDES` by default.

3. Use the Jasypt encrypt command-line tool to encrypt your sensitive configuration values (for example, passwords for use in configuration files). For example, the following command encrypts the `PlainTextVal` value, using the specified algorithm and master password `MasterPass`:

```
./encrypt.sh input="PlainTextVal" algorithm=PBEWithMD5AndDES
password=MasterPass
```

4. Create a properties file with encrypted values. For example, suppose you wanted to store some LDAP credentials. You could create a file, `etc/ldap.properties`, with the following contents:

### Example 2.6. Property File with an Encrypted Property

```
#ldap.properties
ldap.password=ENC(amIsvdqno9iSwnd7kAlLYQ==)
ldap.url=ldap://192.168.1.74:10389
```

The encrypted property values (as generated in the previous step) are identified by wrapping in the `ENC()` function.



5. (*Blueprint XML only*) Add the requisite namespaces to your Blueprint XML file:

- Aries extensions—`http://aries.apache.org/blueprint/xmlns/blueprint-ext/v1.0.0`
- Apache Karaf Jasypt—`http://karaf.apache.org/xmlns/jasypt/v1.0.0`

Example 2.7, “Encrypted Property Namespaces” shows a Blueprint file with the requisite namespaces.

### Example 2.7. Encrypted Property Namespaces

```
<blueprint xmlns="http://www.osgi.org/xmlns/blueprint/v1.0.0"
  xmlns:ext="http://aries.apache.org/blueprint/xmlns/blueprint-
ext/v1.0.0"
  xmlns:enc="http://karaf.apache.org/xmlns/jasypt/v1.0.0">
  ...
</blueprint>
```

6. Configure the location of the properties file for the property placeholder and configure the Jasypt encryption algorithm .

- **Blueprint XML**

Example 2.8, “Jasypt Blueprint Configuration” shows how to configure the `ext:property-placeholder` element to read properties from the `etc/ldap.properties` file. The `enc:property-placeholder` element configures Jasypt to use the `PBESWithMD5AndDES` encryption algorithm and to read the master password from the `JASYPT_ENCRYPTION_PASSWORD` environment variable.

### Example 2.8. Jasypt Blueprint Configuration

```
<blueprint xmlns="http://www.osgi.org/xmlns/blueprint/v1.0.0"
  xmlns:ext="http://aries.apache.org/blueprint/xmlns/blueprint-
ext/v1.0.0"
  xmlns:enc="http://karaf.apache.org/xmlns/jasypt/v1.0.0">

  <ext:property-placeholder>
    <location>file:etc/ldap.properties</location>
  </ext:property-placeholder>

  <enc:property-placeholder>
    <enc:encryptor
class="org.jasypt.encryption.pbe.StandardPBESStringEncryptor">
      <property name="config">
        <bean
class="org.jasypt.encryption.pbe.config.EnvironmentStringPBECon
fig">
          <property name="algorithm" value="PBESWithMD5AndDES"
/>
          <property name="passwordEnvName"
value="JASYPT_ENCRYPTION_PASSWORD" />
        </bean>
      </property>
```

```

        </enc:encryptor>
    </enc:property-placeholder>
    ...
</blueprint>

```

- **Spring XML**

[Example 2.9, “Jasypt Spring Configuration”](#) shows how to configure Jasypt to use the **PBEWithMD5AndDES** encryption algorithm and to read the master password from the **JASYPT\_ENCRYPTION\_PASSWORD** environment variable.

The **EncryptablePropertyPlaceholderConfigurer** bean is configured to read properties from the **etc/ldap.properties** file and to read properties from the **io.fabric8.mq.fabric.ConfigurationProperties** class (which defines the **karaf.base** property, for example).

### Example 2.9. Jasypt Spring Configuration

```

<bean id="environmentVariablesConfiguration"
class="org.jasypt.encryption.pbe.config.EnvironmentStringPBECon
fig">
    <property name="algorithm" value="PBEWithMD5AndDES" />
    <property name="passwordEnvName"
value="JASYPT_ENCRYPTION_PASSWORD" />
</bean>

<bean id="configurationEncryptor"
class="org.jasypt.encryption.pbe.StandardPBEStrngEncryptor">
    <property name="config"
ref="environmentVariablesConfiguration" />
</bean>

<bean id="propertyConfigurer"
class="org.jasypt.spring31.properties.EncryptablePropertyPlaceh
olderConfigurer">
    <constructor-arg ref="configurationEncryptor" />
    <property name="location"
value="file:${karaf.base}/etc/ldap.properties"/>
    <property name="properties">
        <bean
class="io.fabric8.mq.fabric.ConfigurationProperties"/>
    </property>
</bean>

```

7. Use the placeholders in your configuration file. The placeholders you use for encrypted properties are the same as you use for regular properties. Use the syntax **`${prop.name}`**.
8. Make sure that the **jasypt-encryption** feature is installed in the container. If necessary, install the **jasypt-encryption** feature with the following console command:

```
JBossFuse:karaf@root> features:install jasypt-encryption
```

9. Shut down the container, by entering the following command:

```
JBossFuse:karaf@root> shutdown
```

10. Carefully restart the container and deploy your secure application, as follows:

1. Open a command window (first command window) and enter the following commands to start the JBoss Fuse container in the background:

```
export JASYPT_ENCRYPTION_PASSWORD="your super secret master pass
phrase"
./bin/start
```

2. Open a second command window and start the client utility, to connect to the container running in the background:

```
./bin/client -u Username -p Password
```

Where ***Username*** and ***Password*** are valid JAAS user credentials for logging on to the container console.

3. In the second command window, use the console to install your secure application that uses encrypted property placeholders. Check that the application has launched successfully (for example, using the **osgi:list** command to check its status).
4. After the secure application has started up, go back to the first command window and unset the **JASYPT\_ENCRYPTION\_PASSWORD** environment variable.



### IMPORTANT

Unsetting the **JASYPT\_ENCRYPTION\_PASSWORD** environment variable ensures there will be minimum risk of exposing the master password. The Jasypt library retains the master password in encrypted form in memory.

## Blueprint XML example

[Example 2.10, “Jasypt Example in Blueprint XML”](#) shows an example of an LDAP JAAS realm configured in Blueprint XML, using Jasypt encrypted property placeholders.

### Example 2.10. Jasypt Example in Blueprint XML

```
<blueprint xmlns="http://www.osgi.org/xmlns/blueprint/v1.0.0"
  xmlns:ext="http://aries.apache.org/blueprint/xmlns/blueprint-
ext/v1.0.0"
  xmlns:enc="http://karaf.apache.org/xmlns/jasypt/v1.0.0">

  <ext:property-placeholder>
    <location>file:etc/ldap.properties</location>
  </ext:property-placeholder>

  <enc:property-placeholder>
    <enc:encryptor
class="org.jasypt.encryption.pbe.StandardPBEStrngEncryptor">
    <property name="config">
```

```

        <bean
class="org.jasypt.encryption.pbe.config.EnvironmentStringPBEConfig">
    <property name="algorithm" value="PBEWithMD5AndDES" />
    <property name="passwordEnvName"
value="JASYPT_ENCRYPTION_PASSWORD" />
    </bean>
</property>
</enc:encryptor>
</enc:property-placeholder>

<jaas:config name="karaf" rank="200">
    <jaas:module
className="org.apache.karaf.jaas.modules.ldap.LDAPLoginModule"
flags="required">
        initialContextFactory=com.sun.jndi.ldap.LdapCtxFactory
        debug=true
        connectionURL=${ldap.url}

connectionUsername=cn=mqbroker,ou=Services,ou=system,dc=jbossfuse,dc=com
        connectionPassword=${ldap.password}
        connectionProtocol=
        authentication=simple
        userRoleName=cn
        userBase = ou=User,ou=ActiveMQ,ou=system,dc=jbossfuse,dc=com
        userSearchMatching=(uid={0})
        userSearchSubtree=true
        roleBase = ou=Group,ou=ActiveMQ,ou=system,dc=jbossfuse,dc=com
        roleName=cn
        roleSearchMatching= (member:=uid={1})
        roleSearchSubtree=true
    </jaas:module>
</jaas:config>

</blueprint>

```

The `${ldap.password}` placeholder is replaced with the decrypted value of the `ldap.password` property from the `etc/ldap.properties` properties file.

## 2.4. ENABLING REMOTE JMX SSL

### Overview

Red Hat JBoss Fuse provides a JMX port that allows remote monitoring and management of Fuse containers using MBeans. By default, however, the credentials that you send over the JMX connection are unencrypted and vulnerable to snooping. To encrypt the JMX connection and protect against password snooping, you need to secure JMX communications by configuring JMX over SSL.

To configure JMX over SSL, perform the following steps:

1. [Create the `jbossweb.keystore` file](#)
2. [Create and deploy the `keystore.xml` file](#)
3. [Add the required properties to `org.apache.karaf.management.cfg`](#)

#### 4. Restart the container

After you have configured JMX over SSL access, you should test the connection.



### WARNING

If you are planning to enable SSL/TLS security, you must ensure that you explicitly disable the SSLv3 protocol, in order to safeguard against the [Poodle vulnerability \(CVE-2014-3566\)](#). For more details, see [Disabling SSLv3 in JBoss Fuse 6.x and JBoss A-MQ 6.x](#).



### NOTE

If you configure JMX over SSL while Red Hat JBoss Fuse is running, you will need to restart it.

## Prerequisites

If you haven't already done so, you need to:

- Set your **JAVA\_HOME** environment variable
- Configure a JBoss Fuse user with the **Administrator** role

Edit the `<installDir>/jboss-fuse-6.2.0.redhat-133/etc/users.properties` file and add the following entry, on a single line:

```
admin=YourPassword,Administrator
```

This creates a new user with username, **admin**, password, **YourPassword**, and the **Administrator** role.

## Create the `jbossweb.keystore` file

Open a command prompt and make sure you are in the `etc/` directory of your JBoss Fuse installation:

```
cd <installDir>/jboss-fuse-6.2.0.redhat-133/etc
```

At the command line, using a **-dname** value (Distinguished Name) appropriate for your application, type this command:

```
$JAVA_HOME/bin/keytool -genkey -v -alias jbossalias -keyalg RSA -keysize 1024 -keystore jbossweb.keystore -validity 3650 -keypass JbossPassword -storepass JbossPassword -dname "CN=127.0.0.1, OU=RedHat Software Unit, O=RedHat, L=Boston, S=Mass, C=USA"
```

**IMPORTANT**

Type the entire command on a single command line.

The command returns output that looks like this:

```

Generating 1,024 bit RSA key pair and self-signed certificate
(SHA256withRSA) with a validity of 3,650 days
  for: CN=127.0.0.1, OU=RedHat Software Unit, O=RedHat, L=Boston, ST=Mass,
C=USA
New certificate (self-signed):
[
[
  Version: V3
  Subject: CN=127.0.0.1, OU=RedHat Software Unit, O=RedHat, L=Boston,
ST=Mass, C=USA
  Signature Algorithm: SHA256withRSA, OID = 1.2.840.113549.1.1.11

  Key:  Sun RSA public key, 1024 bits
  modulus:
1123086025790567043604962990501918169461098372864273201795342440080393808

15941007760750086474599109914138063728007229476701664078149017544591007202
79046

39446218137381773240310642603826594831938261774487620304376693183910726198
67218

03697233521083906272245608532830105836205236924847365988048833871135195983
5357
  public exponent: 65537
  Validity: [From: Thu Jun 05 12:19:52 EDT 2014,
             To: Sun Jun 02 12:19:52 EDT 2024]
  Issuer: CN=127.0.0.1, OU=RedHat Software Unit, O=RedHat, L=Boston,
ST=Mass, C=USA
  SerialNumber: [ 4666e4e6]

Certificate Extensions: 1
[1]: ObjectId: 2.5.29.14 Criticality=false
SubjectKeyIdentifier [
KeyIdentifier [
0000: AC 44 A5 F2 E6 2F B2 5A   5F 88 FE 69 60 B4 27 7D   .D.../.Z...i`.'.
0010: B9 81 23 9C                               ..#.
]
]

]
  Algorithm: [SHA256withRSA]
  Signature:
0000: 01 1D 95 C0 F2 03 B0 FD   CF 3A 1A 14 F5 2E 04 E5   .....:.....
0010: DD 18 DD 0E 24 60 00 54   35 AE FE 36 7B 38 69 4C   ....$`.T5..6.8iL
0020: 1E 85 0A AF AE 24 1B 40   62 C9 F4 E5 A9 02 CD D3   .....$.@b.....
0030: 91 57 60 F6 EF D6 A4 84   56 BA 5D 21 11 F7 EA 09   .W`.....V.].!....
0040: 73 D5 6B 48 4A A9 09 93   8C 05 58 91 6C D0 53 81   s.kHJ.....X.l.S.
0050: 39 D8 29 59 73 C4 61 BE   99 13 12 89 00 1C F8 38   9.)Ys.a.....8
0060: E2 BF D5 3C 87 F6 3F FA   E1 75 69 DF 37 8E 37 B5   ...<..?..ui.7.7.

```

```
0070: B7 8D 10 CC 9E 70 E8 6D   C2 1A 90 FF 3C 91 84 50   .....p.m....<...P
]
[Storing jbossweb.keystore]
```

Check whether `<installDir>/jboss-fuse-6.2.0.redhat-133/etc` now contains the file `jbossweb.keystore`.

## Create and deploy the keystore.xml file

1. Using your favorite xml editor, create and save the `keystore.xml` file in the `<installDir>/jboss-fuse-6.2.0.redhat-133/etc` directory.
2. Include this text in the file:

```
<blueprint xmlns="http://www.osgi.org/xmlns/blueprint/v1.0.0"
  xmlns:jaas="http://karaf.apache.org/xmlns/jaas/v1.0.0">
  <jaas:keystore name="sample_keystore"
    rank="1"
    path="file:etc/jbossweb.keystore"
    keystorePassword="JbossPassword"
    keyPasswords="jbossalias=JbossPassword" />
</blueprint>
```

3. Deploy the `keystore.xml` file to the container, by copying it into the `<installDir>/jboss-fuse-6.2.0.redhat-133/deploy` directory (the hot deploy directory).

## Add the required properties to org.apache.karaf.management.cfg

Edit the `<installDir>/jboss-fuse-6.2.0.redhat-133/etc/org.apache.karaf.management.cfg` file to include these properties at the end of the file:

```
secured = true
secureProtocol = TLSv1
keyAlias = jbossalias
keyStore = sample_keystore
trustStore = sample_keystore
```



### IMPORTANT

You must set `secureProtocol` to `TLSv1`, in order to protect against the [Poodle vulnerability \(CVE-2014-3566\)](#)

## Restart the JBoss Fuse container

You must restart the JBoss Fuse container for the new JMX SSL/TLS settings to take effect.

## Testing the Secure JMX connection

1. Open a command prompt and make sure you are in the `etc/` directory of your JBoss Fuse installation:

```
cd <installDir>/jboss-fuse-6.2.0.redhat-133/etc
```

2. Open a terminal, and start up JConsole by entering this command:

```
jconsole -J-Djavax.net.debug=ssl -J-  
Djavax.net.ssl.trustStore=jbossweb.keystore -J-  
Djavax.net.ssl.trustStoreType=JKS -J-  
Djavax.net.ssl.trustStorePassword=JbossPassword
```

Where the **-J-Djavax.net.ssl.trustStore** option specifies the location of the **jbossweb.keystore** file (make sure this location is specified correctly, or the SSL/TLS handshake will fail). The **-J-Djavax.net.debug=ssl** setting enables logging of SSL/TLS handshake messages, so you can verify that SSL/TLS has been successfully enabled.

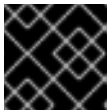

### IMPORTANT

Type the entire command on the same command line.

3. When JConsole opens, select the option **Remote Process** in the **New Connection** wizard.
4. Under the **Remote Process** option, enter the following value for the **service:jmx:**  
**<protocol>:<sap>** connection URL:

```
service:jmx:rmi://localhost:44444/jndi/rmi://localhost:1099/karaf-  
root
```

And fill in the **Username**, and **Password** fields with valid JAAS credentials (as set in the **etc/users.properties** file):

```
Username: admin  
Password: YourPassword
```



## CHAPTER 3. SECURING THE JETTY HTTP SERVER

### Abstract

You can configure the built-in Jetty HTTP server to use SSL/TLS security by adding the relevant configuration properties to the `etc/org.ops4j.pax.web.cfg` configuration file. In particular, you can add SSL/TLS security to the Fuse Management Console in this way.

### JETTY SERVER

The JBoss Fuse container is pre-configured with a Jetty server, which acts as a general-purpose HTTP server and HTTP servlet container. Through a single HTTP port (by default, `http://Host:8181`), the Jetty container can host multiple services, for example:

- Fuse Management Console (by default, `http://Host:8181/hawtio`)
- Apache CXF Web services endpoints (if the host and port are left unspecified in the endpoint configuration)
- Some Apache Camel endpoints

If you use the default Jetty server for all of your HTTP endpoints, you can conveniently add SSL/TLS security to these HTTP endpoints by following the steps described here.

### CREATE X.509 CERTIFICATE AND PRIVATE KEY

Before you can enable SSL, you must create an X.509 certificate and private key for the Web console. The certificate and private key must be in Java keystore format. For details of how to create a signed certificate and private key, see [Appendix A, Managing Certificates](#).

### ENABLING SSL/TLS

To enable SSL/TLS:

1. Open `etc/org.ops4j.pax.web.cfg` in a text editor.
2. Disable the insecure HTTP port by adding the `org.osgi.service.http.enabled` and setting it to `false`; and enable the secure HTTPS port by adding the `org.osgi.service.http.secure.enabled` and setting it to `true`. The `etc/org.ops4j.pax.web.cfg` file should now have the following contents:

```
# Configures the SMX Web Console to use SSL
org.ops4j.pax.web.config.file=etc/jetty.xml

org.osgi.service.http.enabled=false
org.osgi.service.http.port=8181

org.osgi.service.http.secure.enabled=true
```

3. Edit the `etc/jetty.xml` file and add the following `Call` element to configure the SSL connector for Jetty:

```

<?xml version="1.0"?>
<!DOCTYPE Configure PUBLIC "-//Mort Bay Consulting//
DTD Configure//EN" "http://jetty.mortbay.org/configure.dtd">

<Configure class="org.eclipse.jetty.server.Server">

    <!-- ===== -->
    <!-- Set connectors -->
    <!-- ===== -->
    <!-- One of each type! -->
    <!-- ===== -->
    ...
    <Call name="addConnector">
        <Arg>
            <!-- The SslSelectChannelConnector class uses the Java
            NIO SslEngine -->
            <New
            class="org.eclipse.jetty.server.ssl.SslSelectChannelConnector">
                <Arg>
                    <New
                    class="org.eclipse.jetty.http.ssl.SslContextFactory">
                        <!-- Protect against the POODLE security
                        vulnerability -->
                            <Set name="ExcludeProtocols">
                                <Array type="java.lang.String">
                                    <Item>SSLv3</Item>
                                </Array>
                            </Set>
                            <Set
                            name="keyStore">/home/jdoe/Documents/jetty.ks</Set>
                            <Set
                            name="keyStorePassword">mykeystorepass</Set>
                            <Set
                            name="keyManagerPassword">mykeypass</Set>
                            </New>
                        </Arg>
                        <Set name="port">8183</Set>
                        <Set name="maxIdleTime">30000</Set>
                    </New>
                </Arg>
            </Call>
            <Call name="addConnector">
                ...
            </Call>

            <Call name="addBean">
                ...
            </Call>
        </Configure>

```

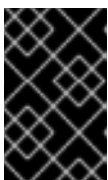

## IMPORTANT

The preceding configuration explicitly disables the SSLv3 protocol, in order to safeguard against the [Poodle vulnerability \(CVE-2014-3566\)](#). For more details, see [Disabling SSLv3 in JBoss Fuse 6.x and JBoss A-MQ 6.x](#).

4. (*Optional*) If you prefer, you can use a system property to help you specify the location of the Java keystore file. For example, instead of setting the **keyStore** property explicitly (in the preceding **etc/jetty.xml** configuration):

```
<Set name="keyStore">/home/jdoe/Documents/jetty.ks</Set>
```

You could use the **karaf.home** system property to specify the location of the keystore file relative to the JBoss Fuse install directory:

```
<Set name="keyStore">
  <SystemProperty name="karaf.home"/>/etc/jetty.ks
</Set>
```

5. Customize the properties of the **SslSocketConnector** instance defined in the **etc/jetty.xml** file, as follows:

#### **port**

The secure HTTPS port number.

#### **keyStore**

The location of the Java keystore file on the file system. Relative paths are resolved relative to the **KARAF\_HOME** environment variable (by default, the install directory).

#### **keyStorePassword**

The *store password* that unlocks the Java keystore file.

#### **keyManagerPassword**

The *key password* that decrypts the private key stored in the keystore (usually the same as the store password).

6. Restart the JBoss Fuse container, in order for the configuration changes to take effect.

## CONNECT TO THE SECURE CONSOLE

After configuring SSL security for the Jetty server in the Pax Web configuration file, you should be able to open the Fuse Management Console by browsing to the following URL:

```
https://localhost:8183/
```



### NOTE

Remember to type the **https:** scheme, instead of **http:**, in this URL.

Initially, the browser will warn you that you are using an untrusted certificate. Skip this warning and you will be presented with the login screen for the Fuse Management Console.

## ADVANCED JETTY SECURITY CONFIGURATION

The Jetty server provides flexible and sophisticated options for configuring security. You can exploit these advanced options by editing the `etc/jetty.xml` file and configuring it as described in the Jetty security documentation:

- [Jetty/Howto/Configure SSL](#)
- [Jetty/Reference/SSL Connectors](#)
- [SslContextFactory](#)
- [API documentation \(all Jetty versions\)](#)

## CHAPTER 4. SECURING THE CAMEL ACTIVEMQ COMPONENT

### Abstract

The Camel ActiveMQ component enables you to define JMS endpoints in your routes that can connect to an Apache ActiveMQ broker. In order to make your Camel ActiveMQ endpoints secure, you must create an instance of a Camel ActiveMQ component that uses a *secure* connection factory.

### 4.1. SECURE ACTIVEMQ CONNECTION FACTORY

#### Overview

Apache Camel provides an Apache ActiveMQ component for defining Apache ActiveMQ endpoints in a route. The Apache ActiveMQ endpoints are effectively Java clients of the broker and you can either define a consumer endpoint (typically used at the start of a route to *poll* for JMS messages) or define a producer endpoint (typically used at the end or in the middle of a route to *send* JMS messages to a broker).

When the remote broker is secure (SSL security, JAAS security, or both), the Apache ActiveMQ component must be configured with the required client security settings.

#### Programming the security properties

Apache ActiveMQ enables you to program SSL security settings (and JAAS security settings) by creating and configuring an instance of the **ActiveMQSslConnectionFactory** JMS connection factory. Programming the JMS connection factory is the correct approach to use in the context of the containers such as OSGi, J2EE, Tomcat, and so on, because these settings are local to the application using the JMS connection factory instance.



#### NOTE

A standalone broker can configure SSL settings using *Java system properties*. For clients deployed in a container, however, this is *not* a practical approach, because the configuration must apply only to individual bundles, not the entire OSGi container. A Camel ActiveMQ endpoint is effectively a kind of Apache ActiveMQ Java client, so this restriction applies also to Camel ActiveMQ endpoints.

#### Defining a secure connection factory

[Example 4.1, “Defining a Secure Connection Factory Bean”](#) shows how to create a secure connection factory bean in Spring XML, enabling both SSL/TLS security *and* JAAS authentication.

##### Example 4.1. Defining a Secure Connection Factory Bean

```
<bean id="jmsConnectionFactory"
      class="org.apache.activemq.ActiveMQSslConnectionFactory">
  <property name="brokerURL" value="ssl://localhost:61617" />
  <property name="userName" value="Username"/>
  <property name="password" value="Password"/>
  <property name="trustStore" value="/conf/client.ts"/>
  <property name="trustStorePassword" value="password"/>
</bean>
```

The following properties are specified on the **ActiveMQSslConnectionFactory** class:

**brokerURL**

The URL of the remote broker to connect to, where this example connects to an SSL-enabled OpenWire port on the local host. The broker must also define a corresponding transport connector with compatible port settings.

**userName and password**

Any valid JAAS login credentials, *Username* and *Password*.

**trustStore**

Location of the Java keystore file containing the certificate trust store for SSL connections. The location is specified as a classpath resource. If a relative path is specified, the resource location is relative to the **org/jbossfuse/example** directory on the classpath.

**trustStorePassword**

The password that unlocks the keystore file containing the trust store.

It is also possible to specify **keyStore** and **keyStorePassword** properties, but these would only be needed, if SSL mutual authentication is enabled (where the client presents an X.509 certificate to the broker during the SSL handshake).

## 4.2. EXAMPLE CAMEL ACTIVEMQ COMPONENT CONFIGURATION

### Overview

This section describes how to initialize and configure a sample Camel ActiveMQ component instance, which you can then use to define ActiveMQ endpoints in a Camel route. This makes it possible for a Camel route to send or receive messages from a broker.

### Prerequisites

The **camel-activemq** feature, which defines the bundles required for the Camel ActiveMQ component, is *not* installed by default. To install the **camel-activemq** feature, enter the following console command:

```
JBossFuse:karaf@root> features:install camel-activemq
```

### Sample Camel ActiveMQ component

The following Spring XML sample shows a complete configuration of a Camel ActiveMQ component that has both SSL/TLS security and JAAS authentication enabled. The Camel ActiveMQ component instance is defined to with the **activemqssl** bean ID, which means it is associated with the **activemqssl** scheme (which you use when defining endpoints in a Camel route).

```
<?xml version="1.0" encoding="UTF-8"?>
<beans ... >
```

```

...
<!--
  Configure the activemqssl component:
-->
<bean id="jmsConnectionFactory"
      class="org.apache.activemq.ActiveMQSslConnectionFactory">
  <property name="brokerURL" value="ssl://localhost:61617" />
  <property name="userName" value="Username"/>
  <property name="password" value="Password"/>
  <property name="trustStore" value="/conf/client.ts"/>
  <property name="trustStorePassword" value="password"/>
</bean>

<bean id="pooledConnectionFactory"
      class="org.apache.activemq.pool.PooledConnectionFactory">
  <property name="maxConnections" value="8" />
  <property name="maximumActive" value="500" />
  <property name="connectionFactory" ref="jmsConnectionFactory" />
</bean>

<bean id="jmsConfig"
class="org.apache.camel.component.jms.JmsConfiguration">
  <property name="connectionFactory" ref="pooledConnectionFactory"/>
  <property name="transacted" value="false"/>
  <property name="concurrentConsumers" value="10"/>
</bean>

<bean id="activemqssl"
      class="org.apache.activemq.camel.component.ActiveMQComponent">
  <property name="configuration" ref="jmsConfig"/>
</bean>

</beans>

```

## Sample Camel route

The following Camel route defines a sample endpoint that sends messages securely to the **security.test** queue on the broker, using the **activemqssl** scheme to reference the Camel ActiveMQ component defined in the preceding example:

```

<?xml version="1.0" encoding="UTF-8"?>
<beans ...>
  ...
  <camelContext xmlns="http://camel.apache.org/schema/spring">
    <route>
      <from uri="timer://myTimer?fixedRate=true&period=5000"/>
      <transform><constant>Hello world!</constant></transform>
      <to uri="activemqssl:security.test"/>
    </route>
  </camelContext>
  ...
</beans>

```

## CHAPTER 5. SECURING THE CAMEL JETTY COMPONENT

### Abstract

### 5.1. ENABLING SSL/TLS SECURITY

#### Overview

This section explains how to enable SSL/TLS security on the Apache Camel Jetty component, which is used to create a HTTPS Web server. The key step is to customize the Jetty component by setting the `sslSocketConnectorProperties` property, which configures SSL/TLS. You must also change the protocol scheme on the Jetty URI from `http` to `https`.

#### Tutorial steps

To configure SSL/TLS security for a Camel Jetty endpoint deployed in the OSGi container, perform the following steps:

1. [the section called “Generate a Maven project”](#).
2. [the section called “Customize the POM file”](#).
3. [the section called “Install sample keystore files”](#).
4. [the section called “Configure Jetty with SSL/TLS”](#).
5. [the section called “Build the bundle”](#).
6. [the section called “Install the camel-jetty feature”](#).
7. [the section called “Deploy the bundle”](#).
8. [the section called “Test the bundle”](#).
9. [the section called “Uninstall the bundle”](#).

#### Generate a Maven project

The `maven-archetype-quickstart` archetype creates a generic Maven project, which you can then customize for whatever purpose you like. To generate a Maven project with the coordinates, `org.jbossfuse.example:jetty-security`, enter the following command:

```
mvn archetype:create
-DarchetypeArtifactId=maven-archetype-quickstart
-DgroupId=org.jbossfuse.example
-DartifactId=jetty-security
```

The result of this command is a directory, `ProjectDir/jetty-security`, containing the files for the generated project.



**NOTE**

*Be careful not to choose a group ID for your artifact that clashes with the group ID of an existing product! This could lead to clashes between your project's packages and the packages from the existing product (because the group ID is typically used as the root of a project's Java package names).*

**Customize the POM file**

You must customize the POM file in order to generate an OSGi bundle. Follow the POM customization steps described in [section "Generating a Bundle Project" in "Deploying into the Container"](#).

Alternatively, edit the **jetty-security/pom.xml** file and replace its contents with the following XML code:

```
<project xmlns="http://maven.apache.org/POM/4.0.0"
xmlns:xsi="http://www.w3.org/2001/XMLSchema-instance"
  xsi:schemaLocation="http://maven.apache.org/POM/4.0.0
http://maven.apache.org/xsd/maven-4.0.0.xsd">
  <modelVersion>4.0.0</modelVersion>

  <groupId>org.jbossfuse.example</groupId>
  <artifactId>jetty-security</artifactId>
  <version>1.0-SNAPSHOT</version>
  <packaging>bundle</packaging>

  <name>jetty-security</name>
  <url>http://maven.apache.org</url>

  <properties>
    <project.build.sourceEncoding>UTF-8</project.build.sourceEncoding>
  </properties>

  <dependencies>
    <dependency>
      <groupId>junit</groupId>
      <artifactId>junit</artifactId>
      <version>3.8.1</version>
      <scope>test</scope>
    </dependency>
  </dependencies>

  <build>
    <defaultGoal>install</defaultGoal>
    <plugins>
      <plugin>
        <groupId>org.apache.felix</groupId>
        <artifactId>maven-bundle-plugin</artifactId>
        <version>2.3.7</version>
        <extensions>>true</extensions>
        <configuration>
          <instructions>
            <Bundle-SymbolicName>${project.groupId}.${project.artifactId}
</Bundle-SymbolicName>
            <Import-Package>*</Import-Package>
          </instructions>
```

```

        </configuration>
    </plugin>

    <plugin>
        <groupId>org.apache.maven.plugins</groupId>
        <artifactId>maven-compiler-plugin</artifactId>
        <configuration>
            <source>1.7</source>
            <target>1.7</target>
        </configuration>
    </plugin>
</plugins>
</build>

</project>

```

## Install sample keystore files

The certificates used in this demonstration are taken from a sample in the Apache CXF 3.0.4.redhat-620133 distribution, which is included in the ***InstallDir/extras*** directory. Using a standard archive utility, expand the CXF archive file and extract the contents to a convenient location on your filesystem. You will find the sample certificates in the ***CXFInstallDir/samples/wsd1\_first\_https/src/main/config*** directory.

Copy the ***clientKeystore.jks*** certificate and the ***serviceKeystore.jks*** certificate from the ***CXFInstallDir/samples/wsd1\_first\_https/src/main/config*** directory to the ***EsbInstallDir/etc/certs*** directory (where you will need to create the ***etc/certs*** sub-directory). After copying, you should have the following directory structure under ***EsbInstallDir/etc/***:

```

EsbInstallDir/etc/
|
|--certs/
|
|--clientKeystore.jks
serviceKeystore.jks

```

Where ***clientKeystore.jks***, and ***serviceKeystore.jks*** are the keystores that are used in this demonstration.



### WARNING

The demonstration key store and trust store are provided for testing purposes only. *Do not deploy these certificates in a production system.* To set up a genuinely secure SSL/TLS system, you must generate custom certificates, as described in [Appendix A, Managing Certificates](#).

## Configure Jetty with SSL/TLS

The Jetty Web server is created by defining a Jetty endpoint at the start of an Apache Camel route. The

route is then responsible for processing the incoming HTTP request and generating a reply. The current example simply sends back a small HTML page in the reply. For a more realistic application, you would typically process the incoming message using a bean, which accesses the message through the Java servlet API.

Create the following directory to hold the Spring configuration files:

```
ProjectDir/jetty-security/src/main/resources/META-INF/spring
```

In the **spring** directory that you just created, use your favourite text editor to create the file, **jetty-spring.xml**, containing the following XML configuration:

```
<?xml version="1.0" encoding="UTF-8"?>
<beans xmlns="http://www.springframework.org/schema/beans"
xmlns:xsi="http://www.w3.org/2001/XMLSchema-instance" xsi:schemaLocation="
    http://www.springframework.org/schema/beans
http://www.springframework.org/schema/beans/spring-beans-3.0.xsd
    http://activemq.apache.org/schema/core
http://activemq.apache.org/schema/core/activemq-core-5.4.0.xsd
    http://camel.apache.org/schema/spring
http://camel.apache.org/schema/spring/camel-spring.xsd">

    <bean id="jetty"
class="org.apache.camel.component.jetty8.JettyHttpComponent8">
        <property name="sslContextParameters" ref="sslContextParameters"
/>
    </bean>

    <sslContextParameters id="sslContextParameters"
xmlns="http://camel.apache.org/schema/spring">
        <secureSocketProtocols>
            <!-- Do NOT enable SSLv3 (POODLE vulnerability) -->
            <secureSocketProtocol>TLSv1</secureSocketProtocol>
            <secureSocketProtocol>TLSv1.1</secureSocketProtocol>
            <secureSocketProtocol>TLSv1.2</secureSocketProtocol>
        </secureSocketProtocols>
        <keyManagers keyPassword="skpass">
            <keyStore resource="etc/certs/serviceKeystore.jks"
password="sspass"/>
        </keyManagers>
        <trustManagers>
            <keyStore resource="etc/certs/serviceKeystore.jks"
password="sspass"/>
        </trustManagers>
    </sslContextParameters>

    <camelContext trace="true"
xmlns="http://camel.apache.org/schema/spring">
        <route>
            <from uri="jetty:https://0.0.0.0:8282/services?
matchOnUriPrefix=true"/>
            <transform>
                <constant>&lt;html&gt;body>Hello from Fuse ESB
server&lt;/body&lt;/html&lt;/constant>
            </transform>
        </route>
```

```

    </camelContext>
</beans>

```

The **jetty** bean defines a new instance of the Apache Camel Jetty component, overriding the default component defined in the **camel-jetty** JAR file. This Jetty component is configured using the **sslContextParameters** element, as follows:

### secureSocketProtocols

Explicitly lists the SSL/TLS protocols supported by the Jetty server.



### IMPORTANT

This configuration explicitly disables the SSLv3 protocol, in order to safeguard against the [Poodle vulnerability \(CVE-2014-3566\)](#). For more details, see [Disabling SSLv3 in JBoss Fuse 6.x and JBoss A-MQ 6.x](#).

### keyManagers/@keyPassword

The password that decrypts the private key stored in the keystore (usually having the same value as **password**).

### keyManagers/keystore/@resource

The location of the Java keystore file (in JKS format) containing the Jetty server's own X.509 certificate and private key. This location is specified on the filesystem (*not* on the classpath), relative to the directory where the OSGi container is started.

### keyManagers/keystore/@password

The keystore password that unlocks the keystore.

### trustManagers/@resource

The location of the Java keystore file containing one or more trusted certificates (that is, the CA certificates that have been used to sign X.509 certificates from trusted clients). This location is specified on the filesystem (*not* on the classpath), relative to the directory where the OSGi container is started.

Strictly speaking, this property is not needed, if clients do not send certificates to the Jetty service.

### trustManagers/@password

The keystore password that unlocks the **truststore** trust store.

You must also modify the URI at the start of the route (the **uri** attribute of the **from** element). Make sure that the scheme of the URI matches the secure Jetty component, **jetty**, that you have just created. You must also change the protocol scheme from **http** to **https**.



### NOTE

Always double-check you have changed the protocol scheme to **https**. This is such a small change, it is easy to forget.

## Build the bundle

Use Maven to build the bundle. Open a command prompt, switch the current directory to *ProjectDir/jetty-security*, and enter the following command:

```
mvn install -Dmaven.test.skip=true
```

This command builds the bundle and installs it in your local Maven repository.

## Install the camel-jetty feature

If you have not already done so, start up the Apache ServiceMix console (and container instance) by entering the following command in a new command prompt:

```
./fuse
```

The **camel-jetty** feature, which defines the bundles required for the Camel/Jetty component, is *not* installed by default. To install the **camel-jetty** feature, enter the following console command:

```
JBossFuse:karaf@root> features:install camel-jetty
```

## Deploy the bundle

To deploy and activate the bundle, enter the following console command:

```
JBossFuse:karaf@root> osgi:install -s mvn:org.jbossfuse.example/jetty-security
```

The preceding command loads the bundle from your local Maven repository. You might need to configure the Mvn URL handler with the location of your local Maven repository, if the bundle cannot be found (see [section "Mvn URL Handler" in "Deploying into the Container"](#)).

## Test the bundle

To test the Jetty service, enter the following **curl** command at a command-line prompt:

```
curl https://0.0.0.0:8282/services -k
```



### NOTE

Don't forget to use **https:** instead of **http:** in the URL!

The **-k** flag allows **curl** to skip the SSL certificate check (that is, checking that the received server certificate is signed by a local CA certificate), so that the server identity is not verified. You should receive the following HTTP response:

```
<html><body>Hello from Fuse ESB server</body></html>
```

## Uninstall the bundle

To uninstall the broker bundle, you need to know its bundle ID, *BundleID*, in which case you can uninstall it by entering the following console command:

```
JBossFuse:karaf@root> osgi:uninstall BundleID
```

## 5.2. BASIC AUTHENTICATION WITH JAAS

### Overview

The HTTP BASIC authentication protocol is a simple username/password authentication mechanism that is integrated into HTTP and is supported by most Web browsers. To enable BASIC authentication in Jetty, you use the Jetty security API, which enables BASIC authentication by associating a security handler with the Jetty endpoint.

Jetty also enables you to plug in a JAAS login module to perform the credentials check. Using this feature, it is possible to integrate credentials checking with any JAAS realm provided by the Red Hat JBoss Fuse OSGi container. In the example shown here, the Jetty authentication is integrated with the default JAAS realm, **karaf**.

### Prerequisites

This example builds on the project created in [Section 5.1, “Enabling SSL/TLS Security”](#). You must complete the steps in the Jetty SSL/TLS example before proceeding with this tutorial.



#### NOTE

In any case, it is highly recommended that you *always* enable SSL/TLS in combination with BASIC authentication, in order to protect against password snooping.

### Authentication steps

To configure HTTP BASIC authentication for a Camel Jetty endpoint deployed in the OSGi container, perform the following steps:

1. [the section called “Add the Jetty security handler configuration”](#).
2. [the section called “Modify Camel Jetty endpoint”](#).
3. [the section called “Add required package imports to POM”](#).
4. [the section called “Build the bundle”](#).
5. [the section called “Install the required features”](#).
6. [the section called “Deploy the bundle”](#).
7. [the section called “Test the bundle”](#).

### Add the Jetty security handler configuration

In the **jetty-security** project, edit the **jetty-spring.xml** file from the **src/main/resources/META-INF/spring** directory. To configure the Jetty security handler with BASIC authentication, add the following bean definitions:

```

<?xml version="1.0" encoding="UTF-8"?>
<beans ...>
    ...
    <!-- -->
    <bean id="loginService"
class="org.eclipse.jetty.plus.jaas.JAASLoginService">
    <property name="name" value="karaf"/>
    <property name="loginModuleName" value="karaf"/>
    <property name="roleClassNames">
        <list>
<value>org.apache.karaf.jaas.boot.principal.RolePrincipal</value>
        </list>
    </property>
    </bean>

    <bean id="identityService"
class="org.eclipse.jetty.security.DefaultIdentityService"/>

    <bean id="constraint"
class="org.eclipse.jetty.util.security.Constraint">
    <property name="name" value="BASIC"/>
    <property name="roles" value="Administrator"/>
    <property name="authenticate" value="true"/>
    </bean>

    <bean id="constraintMapping"
class="org.eclipse.jetty.security.ConstraintMapping">
    <property name="constraint" ref="constraint"/>
    <property name="pathSpec" value="/*"/>
    </bean>

    <bean id="securityHandler"
class="org.eclipse.jetty.security.ConstraintSecurityHandler">
    <property name="authenticator">
        <bean
class="org.eclipse.jetty.security.authentication.BasicAuthenticator"/>
    </property>
    <property name="constraintMappings">
        <list>
            <ref bean="constraintMapping"/>
        </list>
    </property>
    <property name="loginService" ref="loginService"/>
    <property name="strict" value="false"/>
    <property name="identityService" ref="identityService"/>
    </bean>
    ...
</beans>

```

Two aspects of Jetty authentication are configured by the preceding bean definitions:

- *HTTP BASIC authentication*—the **constraint** bean enables HTTP BASIC authentication on the Jetty security handler. The **roles** property (of **String[]** type) is used to define which roles have access to the Jetty container. In this example, this property is set to **Administrator**, so

only users with the **Administrator** role can access this Jetty container.

- *JAAS login service*—the **loginService** bean specifies that the requisite authentication data is extracted from a JAAS realm. The **loginModuleName** property specifies that the Jetty login service uses the **karaf** JAAS realm, which is the OSGi container's default JAAS realm (see [Section 1.1, “OSGi Container Security”](#)).

## Modify Camel Jetty endpoint

After creating the Jetty **securityHandler** bean, you must modify the Jetty endpoint URI in the Apache Camel route, so that it hooks into the security handler. To add the security handler to the Jetty endpoint, set the **handlers** option equal to the security handler's bean ID, as shown in the following example:

```
<beans ...>
  <camelContext trace="true"
xmlns="http://camel.apache.org/schema/spring">
    <route>
      <from
uri="jetty:https://0.0.0.0:8282/services?handlers=securityHandler&matchOnUriPrefix=true"/>
        <transform>
          <constant>&lt;html&lt;body>Hello from Fuse ESB
server&lt;/body&lt;/html&lt;/constant>
        </transform>
      </route>
    </camelContext>
  </beans>
```

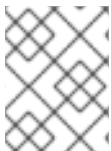

### NOTE

URI options must be separated by the **&amp;** entity, instead of the plain **&** character, in the context of an XML file.

## Add required package imports to POM

Edit the **jetty-security** project's POM file, **jetty-security/pom.xml**. Near the start of the POM file, define the **jetty-version** property as follows:

```
<project ... >
  ...
  <properties>
    ...
    <jetty-version>8.1.17.v20150415</jetty-version>
  </properties>
  ...
</project>
```

Further down the POM file, in the configuration of the Maven bundle plug-in, modify the bundle instructions to import additional Java packages, as follows:

```
<project ... >
  ...
  <build>
```



```

...
<plugin>
  <groupId>org.apache.felix</groupId>
  <artifactId>maven-bundle-plugin</artifactId>
  <extensions>>true</extensions>
  <configuration>
    <instructions>
      <Bundle-SymbolicName>
        ${project.artifactId}
      </Bundle-SymbolicName>
      <Import-Package>
        javax.security.auth,
        javax.security.auth.callback,
        javax.security.auth.login,
        javax.security.auth.spi,
        org.apache.karaf.jaas.modules,
        org.apache.karaf.jaas.boot.principal,
        org.eclipse.jetty.plus.jaas;version=${jetty-version},
        org.eclipse.jetty.security;version=${jetty-version},
        *
      </Import-Package>
      <Private-Package>org.apache.camel.jaas</Private-Package>
    </instructions>
  </configuration>
</plugin>
</plugins>
</build>
...
</project>

```



## NOTE

These extra imports are required, because the Maven bundle plug-in is not capable of scanning Spring files to determine their package dependencies automatically.

## Build the bundle

Use Maven to build the bundle. Open a command prompt, switch the current directory to **ProjectDir/jetty-security**, and enter the following command:

```
mvn install
```

## Install the required features

If you have not already done so, start up the JBoss Fuse container by entering the following command in a new command prompt:

```
./fuse
```

Install the **jetty** and **camel-jetty** features, by entering the following console commands:

```
karaf@root> features:install jetty
karaf@root> features:install camel-jetty
```

## Deploy the bundle

To deploy and activate the bundle, enter the following console command:

```
JBossFuse:karaf@root> osgi:install -s mvn:org.jbossfuse.example/jetty-
security
```

## Test the bundle

To test the Jetty service, enter the following `curl` command at a command-line prompt:

```
curl https://0.0.0.0:8282/services -k --user Username:Password
```



### NOTE

Don't forget to use **https:** instead of **http:** in the URL!

The `--user` option is needed to specify the BASIC authentication credentials. For the **Username** and **Password** values, specify valid JAAS credentials (the valid credentials you can use for this step are specified in the ***EsbInstallDir/etc/users.properties*** file). You should now receive the following HTTP reply message:

```
<html><body>Hello from Fuse ESB server</body></html>
```

## CHAPTER 6. SECURING THE CAMEL CXF COMPONENT

### Abstract

This chapter explains how to enable SSL/TLS security on a Camel CXF endpoint, using the Camel CXF proxy demonstration as the starting point. The Camel CXF component enables you to add Apache CXF endpoints to your Apache Camel routes. This makes it possible to simulate a Web service in Apache Camel or you could interpose a route between a WS client and a Web service to perform additional processing (which is the case considered here).

### 6.1. THE CAMEL CXF PROXY DEMONSTRATION

#### Overview

In order to explain how to secure a Camel CXF endpoint in OSGi, this tutorial builds on an example available from the standalone distribution of Apache Camel, the *Camel CXF proxy* demonstration. [Figure 6.1, “Camel CXF Proxy Overview”](#) gives an overview of how this demonstration works

**Figure 6.1. Camel CXF Proxy Overview**

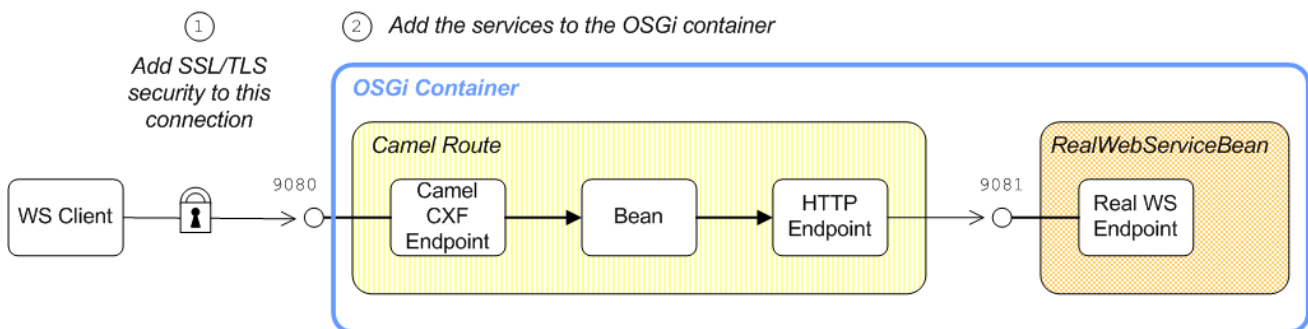

The *report incident* Web service, which is implemented by the **RealWebServiceBean**, receives details of an incident (for example, a traffic accident) and returns a tracking code to the client. Instead of sending its requests directly to the real Web service, however, the WS client connects to a Camel CXF endpoint, which is interposed between the WS client and the real Web service. The Apache Camel route performs some processing on the WSDL message (using the **enrichBean**) before forwarding it to the real Web service.



#### WARNING

If you enable SSL/TLS security, you must ensure that you explicitly disable the SSLv3 protocol, in order to safeguard against the [Poodle vulnerability \(CVE-2014-3566\)](#). For more details, see [Disabling SSLv3 in JBoss Fuse 6.x and JBoss A-MQ 6.x](#).

#### Modifications

In order to demonstrate how to enable SSL/TLS on a Camel CXF endpoint in the context of OSGi, this chapter contains instructions on how to modify the basic demonstration as follows:

1. SSL/TLS security is enabled on the connection between the WS client and the Camel CXF endpoint.
2. The Apache Camel route and the **RealWebServiceBean** bean are both deployed into the OSGi container.

## Obtaining the demonstration code

The Camel CXF proxy demonstration is available only from the standalone distribution of Apache Camel, which is included in the ***InstallDir/extras*** directory. Using a standard archive utility, expand the Camel archive file and extract the contents to a convenient location on your filesystem.

Assuming that you have installed Apache Camel in *CamelInstallDir*, you can find the Camel CXF proxy demonstration in the following directory:

```
CamelInstallDir/examples/camel-example-cxf-proxy
```

## Obtaining the sample certificates

This demonstration needs X.509 certificates. In a real deployment, you should generate these certificates yourself using a private certificate authority. For this demonstration, however, we use some sample certificates from the Apache CXF ***wSDL\_first\_http*** example. This demonstration is available from the standalone distribution of Apache CXF, which is included in the ***InstallDir/extras*** directory. Using a standard archive utility, expand the CXF archive file and extract the contents to a convenient location on your filesystem.

Assuming that you have installed Apache CXF in *CXFInstallDir*, you can find the ***wSDL\_first\_http*** demonstration in the following directory:

```
CXFInstallDir/samples/wSDL_first_http
```

## Physical part of the WSDL contract

The physical part of the WSDL contract refers to the ***wSDL:service*** and ***wSDL:port*** elements. These elements specify the transport details that are needed to connect to a specific Web services endpoint. For the purposes of this demonstration, this is the most interesting part of the contract and it is shown in [Example 6.1, “The ReportIncidentEndpointService WSDL Service”](#).

### Example 6.1. The ReportIncidentEndpointService WSDL Service

```
<wSDL:definitions xmlns:soap="http://schemas.xmlsoap.org/wSDL/soap/"
  ...
  xmlns:wSDL="http://schemas.xmlsoap.org/wSDL/"
  targetNamespace="http://reportincident.example.camel.apache.org">
  ...
  <!-- Service definition -->
  <wSDL:service name="ReportIncidentEndpointService">
    <wSDL:port name="ReportIncidentEndpoint"
binding="tns:ReportIncidentBinding">
      <soap:address location="http://localhost:9080/camel-
example-cxf-proxy/webservices/incident"/>
    </wSDL:port>
```

```

    </wsdl:service>
</wsdl:definitions>

```



## NOTE

The address URL appearing in the WSDL contract (the value of the **soap:address** element's **location** attribute) is not important here, because the application code overrides the default value of the address URL.

## WSDL addressing details

A WS client needs three pieces of information to connect to a WSDL service: the *WSDL service name*, the *WSDL port name*, and the *address URL* of the Web service. The following addressing details are used to connect to the proxy Web service and to the real Web service in this example:

### WSDL service name

The full QName of the WSDL service is as follows:

```
{http://reportincident.example.camel.apache.org}ReportIncidentEndpointService
```

### WSDL port name

The full QName of the WSDL port is as follows:

```
{http://reportincident.example.camel.apache.org}ReportIncidentEndpoint
```

### Address URL

The address URL of the *proxy Web service* endpoint (which uses the HTTPS protocol) is as follows:

```
https://localhost:9080/camel-example-cxf-proxy/webservices/incident
```

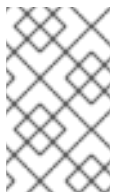

## NOTE

The preceding address is specified when the **reportIncident** bean is created using a **cx:cxEndpoint** element in the bundle's Spring configuration file, **src/main/resources/META-INF/spring/camel-config.xml**.

The address URL of the *real Web service* endpoint (using the HTTP protocol) is as follows:

```
http://localhost:9081/real-webservice
```



## NOTE

The preceding address is specified when the **realWebService** bean is created in the bundle's Spring configuration file, **src/main/resources/META-INF/spring/camel-config.xml**.

## 6.2. SECURING THE WEB SERVICES PROXY

### Overview

This section explains how to enable SSL/TLS security on the Camel CXF endpoint, which acts as a proxy for the real Web service. Assuming that you already have the X.509 certificates available, all that is required is to add a block of configuration data to the Spring configuration file (where the configuration data is contained in a `httpj:engine-factory` element). There is just one slightly subtle aspect to this, however: you need to understand how the Camel CXF endpoint gets associated with the SSL/TLS configuration details.

### Implicit configuration

A WS endpoint can be configured by creating the endpoint in Spring and then configuring SSL/TLS properties on its Jetty container. The configuration can be somewhat confusing, however, for the following reason: the Jetty container (which is configured by a `httpj:engine-factory` element in Spring) *does not explicitly reference the WS endpoints it contains* and the WS endpoints *do not explicitly reference the Jetty container* either. The connection between the Jetty container and its contained endpoints is established implicitly, in that they are both configured to use the same IP port, as illustrated by Figure 6.2, “WS Endpoint Implicitly Configured by `httpj:engine-factory` Element”.

**Figure 6.2. WS Endpoint Implicitly Configured by `httpj:engine-factory` Element**

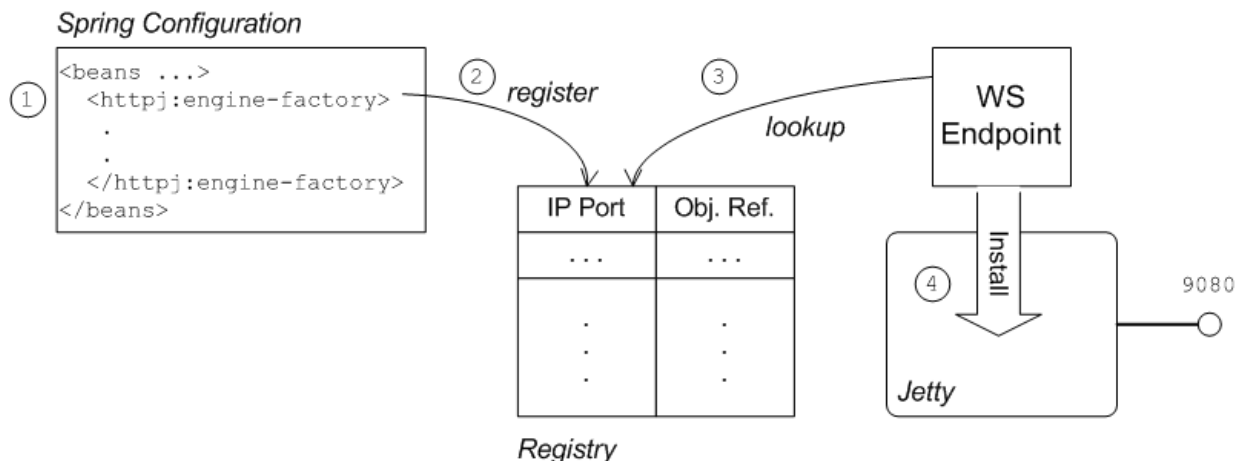

The connection between the Web service endpoint and the `httpj:engine-factory` element is established as follows:

1. The Spring container loads and parses the file containing the `httpj:engine-factory` element.
2. When the `httpj:engine-factory` bean is created, a corresponding entry is created in the registry, storing a reference to the bean. The `httpj:engine-factory` bean is also used to initialize a Jetty container that listens on the specified IP port.
3. When the WS endpoint is created, it scans the registry to see if it can find a `httpj:engine-factory` bean with the same IP port as the IP port in the endpoint's address URL.
4. If one of the beans matches the endpoint's IP port, the WS endpoint installs itself into the corresponding Jetty container. If the Jetty container has SSL/TLS enabled, the WS endpoint shares those security settings.

### Steps to add SSL/TLS security to the Jetty container

To add SSL/TLS security to the Jetty container, thereby securing the WS proxy endpoint, perform the following steps:

1. the section called “Add certificates to the bundle resources”.
2. the section called “Modify POM to switch off resource filtering”.
3. the section called “Instantiate the CXF Bus”.
4. the section called “Add the httpj:engine-factory element to Spring configuration”.
5. the section called “Define the cxfcore:, sec: and httpj: prefixes”.
6. the section called “Modify proxy address URL to use HTTPS”.

## Add certificates to the bundle resources

The certificates used in this demonstration are taken from a sample in the Apache CXF 3.0.4.redhat-620133 product. If you install the standalone version of Apache CXF (available in the *InstallDir/extras/* directory), you will find the sample certificates in the *CXFInstallDir/samples/wsd1\_first\_https/src/main/config* directory.

Copy the *clientKeystore.jks* and *serviceKeystore.jks* keystores from the *CXFInstallDir/samples/wsd1\_first\_https/src/main/config* directory to the *CamelInstallDir/examples/camel-example-cxf-proxy/src/main/resources/certs* directory (you must first create the *certs* sub-directory).

## Modify POM to switch off resource filtering

Including the certificates directly in the bundle as resource is the most convenient way to deploy them. But when you deploy certificates as resources in a Maven project, you must remember to disable Maven resource filtering, which corrupts binary files.

To disable filtering of *.jks* files in Maven, open the project POM file, *CamelInstallDir/examples/camel-example-cxf-proxy/pom.xml*, with a text editor and add the following *resources* element as a child of the *build* element:

```
<?xml version="1.0" encoding="UTF-8"?>
...
<project ...>
...
  <build>
    <plugins>
      ...
    </plugins>

    <resources>
      <resource>
        <directory>src/main/resources</directory>
        <filtering>>true</filtering>
        <excludes>
          <exclude>**/*.jks</exclude>
        </excludes>
      </resource>
    </resources>
  </build>
</project>
```

```

        <directory>src/main/resources</directory>
        <filtering>>false</filtering>
        <includes>
            <include>**/*.jks</include>
        </includes>
    </resource>
</resources>
</build>

</project>

```

## Instantiate the CXF Bus

You should instantiate the CXF bus explicitly in the Spring XML (this ensures that it will be available to the Jetty container, which is instantiated by the `httpj:engine-factory` element in the next step). Edit the `camel-config.xml` file in the `src/main/resources/META-INF/spring` directory, adding the `cxfc core:bus` element as a child of the `beans` element, as follows:

```

<beans ... >
    ...
    <cxfc core:bus/>
    ...
</beans>

```



### NOTE

The `cxfc core:` namespace prefix will be defined in a later step.

## Add the `httpj:engine-factory` element to Spring configuration

To configure the Jetty container that listens on IP port 9080 to use SSL/TLS security, edit the `camel-config.xml` file in the `src/main/resources/META-INF/spring` directory, adding the `httpj:engine-factory` element as shown in [Example 6.2, “httpj:engine-factory Element with SSL/TLS Enabled”](#).

In this example, the `required` attribute of the `sec:clientAuthentication` element is set to `false`, which means that a connecting client is *not* required to present an X.509 certificate to the server during the SSL/TLS handshake (although it may do so, if it has such a certificate).

### Example 6.2. `httpj:engine-factory` Element with SSL/TLS Enabled

```

<beans ... >
    ...
    <httpj:engine-factory bus="cxf">
        <httpj:engine port="{proxy.port}">
            <httpj:tlsServerParameters secureSocketProtocol="TLSv1">
                <sec:keyManagers keyPassword="skpass">
                    <sec:keyStore resource="certs/serviceKeystore.jks"
password="sspass" type="JKS"/>
                </sec:keyManagers>
                <sec:trustManagers>
                    <sec:keyStore resource="certs/serviceKeystore.jks"
password="sspass" type="JKS"/>
                </sec:trustManagers>
            </httpj:tlsServerParameters>
        </httpj:engine>
    </httpj:engine-factory>
    ...
</beans>

```



```

        </sec:trustManagers>
        <sec:cipherSuitesFilter>
            <sec:include>.*_WITH_3DES_.*</sec:include>
            <sec:include>.*_WITH_DES_.*</sec:include>
            <sec:exclude>.*_WITH_NULL_.*</sec:exclude>
            <sec:exclude>.*_DH_anon_.*</sec:exclude>
        </sec:cipherSuitesFilter>
        <sec:clientAuthentication want="true" required="false"/>
    </httpj:tlsServerParameters>
</httpj:engine>
</httpj:engine-factory>

</beans>

```



### IMPORTANT

You must set `secureSocketProtocol` to `TLSv1` on the server side, in order to protect against the [Poodle vulnerability \(CVE-2014-3566\)](#)

### Define the `cxfcORE:`, `sec:` and `httpj:` prefixes

Define the `cxfcORE:`, `sec:` and `httpj:` namespace prefixes, which appear in the definitions of the `cxfcORE:bus` element and the `httpj:engine-factory` element, by adding the following highlighted lines to the `beans` element in the `camel-config.xml` file:

```

<beans xmlns="http://www.springframework.org/schema/beans"
    xmlns:xsi="http://www.w3.org/2001/XMLSchema-instance"
    xmlns:camel="http://camel.apache.org/schema/spring"
    xmlns:cxf="http://camel.apache.org/schema/cxf"
    xmlns:context="http://www.springframework.org/schema/context"
    xmlns:cxfcORE="http://cxf.apache.org/core"
    xmlns:sec="http://cxf.apache.org/configuration/security"
    xmlns:httpj="http://cxf.apache.org/transports/http-
jetty/configuration"
    xsi:schemaLocation="
        http://www.springframework.org/schema/beans
http://www.springframework.org/schema/beans/spring-beans.xsd
        http://camel.apache.org/schema/spring
http://camel.apache.org/schema/spring/camel-spring.xsd
        http://camel.apache.org/schema/cxf
http://camel.apache.org/schema/cxf/camel-cxf.xsd
        http://www.springframework.org/schema/context
http://www.springframework.org/schema/context/spring-context.xsd
        http://cxf.apache.org/core http://cxf.apache.org/schemas/core.xsd
        http://cxf.apache.org/configuration/security
http://cxf.apache.org/schemas/configuration/security.xsd
        http://cxf.apache.org/transports/http-jetty/configuration
http://cxf.apache.org/schemas/configuration/http-jetty.xsd
    ">

```

**NOTE**

It is essential to specify the locations of the <http://cxf.apache.org/configuration/security> schema and the <http://cxf.apache.org/transport/http-jetty/configuration> schema in the `xsi:schemaLocation` attribute. These will not automatically be provided by the OSGi container.

**Modify proxy address URL to use HTTPS**

The proxy endpoint at the start of the Apache Camel route is configured by the `cxf:cxfEndpoint` element in the `camel-config.xml` file. By default, this proxy endpoint is configured to use the HTTP protocol. You must modify the address URL to use the secure HTTPS protocol instead, however. In the `camel-config.xml` file, edit the address attribute of the `cxf:cxfEndpoint` element, replacing the `http:` prefix by the `https:` prefix, as shown in the following fragment:

```
<beans ...>
  ...
  <cxf:cxfEndpoint id="reportIncident"
                  address="https://localhost:${proxy.port}/camel-
example-cxf-proxy/webservices/incident"
                  endpointName="s:ReportIncidentEndpoint"
                  serviceName="s:ReportIncidentEndpointService"
                  wsdlURL="etc/report_incident.wsdl"

xmlns:s="http://reportincident.example.camel.apache.org"/>
  ...
</beans>
```

Notice also that the address URL is configured to use the IP port, `${proxy.port}` (which has the value `9080` by default). This IP port value is the same as the value set for the Jetty container (configured by the `http:engine-factory` element), thus ensuring that this endpoint is deployed into the Jetty container. The attributes of the `cxf:cxfEndpoint` specify the WSDL addressing details as described in [the section called "WSDL addressing details"](#):

**serviceName**

Specifies the WSDL service name.

**endpointName**

Specifies the WSDL port name.

**address**

Specifies the address URL of the proxy Web service.

**6.3. DEPLOYING THE APACHE CAMEL ROUTE****Overview**

The Maven POM file in the basic Camel CXF proxy demonstration is already configured to generate an OSGi bundle. Hence, after building the demonstration using Maven, the demonstration bundle (which contains the Apache Camel route and the `RealWebServicesBean` bean) is ready for deployment into

the OSGi container.

## Prerequisites

Before deploying the Apache Camel route into the OSGi container, you must configure the proxy Web service to use SSL/TLS security, as described in the previous section, [Section 6.2, “Securing the Web Services Proxy”](#).

## Steps to deploy the Camel route

To deploy the Web services proxy demonstration into the OSGi container, perform the following steps:

1. [the section called “Build the demonstration”](#).
2. [the section called “Start the OSGi container”](#).
3. [the section called “Install the required features”](#).
4. [the section called “Deploy the bundle”](#).
5. [the section called “Check the console output”](#).

## Build the demonstration

Use Maven to build and install the demonstration as an OSGi bundle. Open a command prompt, switch the current directory to `CamelInstallDir/examples/camel-example-cxf-proxy`, and enter the following command:

```
mvn install -Dmaven.test.skip=true
```

## Start the OSGi container

If you have not already done so, start up the Apache ServiceMix console (and container instance) by entering the following command in a new command prompt:

```
./fuse
```

## Install the required features

The `camel-cxf` feature, which defines the bundles required for the Camel/CXF component, is *not* installed by default. To install the `camel-cxf` feature, enter the following console command:

```
JBossFuse:karaf@root> features:install camel-cxf
```

You also need the `camel-http` feature, which defines the bundles required for the Camel/HTTP component. To install the `camel-http` feature, enter the following console command:

```
JBossFuse:karaf@root> features:install camel-http
```

## Deploy the bundle

Deploy the `camel-example-cxf-proxy` bundle, by entering the following console command:

```
JBossFuse:karaf@root> install -s mvn:org.apache.camel/camel-example-cxf-proxy/2.15.1.redhat-620133
```

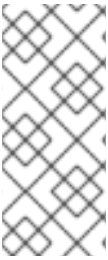

## NOTE

In this case, it is preferable to deploy the bundle directly using **install**, rather than using hot deploy, so that you can see the bundle output on the console screen.

If you have any difficulty using the **mvn** URL handler, see [section "Mvn URL Handler" in "Deploying into the Container"](#) for details of how to set it up.

## Check the console output

After the bundle is successfully deployed, you should see output like the following in the console window:

```
JBossFuse:karaf@root> Starting real web service...
Started real web service at: http://localhost:9081/real-webservice
```

## 6.4. SECURING THE WEB SERVICES CLIENT

### Overview

In the basic Camel CXF proxy demonstration, the Web services client is actually implemented as a JUnit test under the **src/test** directory. This means that the client can easily be run using the Maven command, **mvn test**. To enable SSL/TLS security on the client, the Java implementation of the test client is completely replaced and a Spring file, containing the SSL/TLS configuration, is added to the **src/test/resources/META-INF/spring** directory. Before describing the steps you need to perform to set up the client, this section explains some details of the client's Java code and Spring configuration.

### Implicit configuration

Apart from changing the URL scheme on the endpoint address to **https:**, most of the configuration to enable SSL/TLS security on a client proxy is contained in a **http:conduit** element in Spring configuration. The way in which this configuration is applied to the client proxy, however, is potentially confusing, for the following reason: the **http:conduit** element *does not explicitly reference the client proxy* and the client proxy *does not explicitly reference the http:conduit element*. The connection between the **http:conduit** element and the client proxy is established implicitly, in that they both reference the same WSDL port, as illustrated by [Figure 6.3, "Client Proxy Implicitly Configured by http:conduit Element"](#).

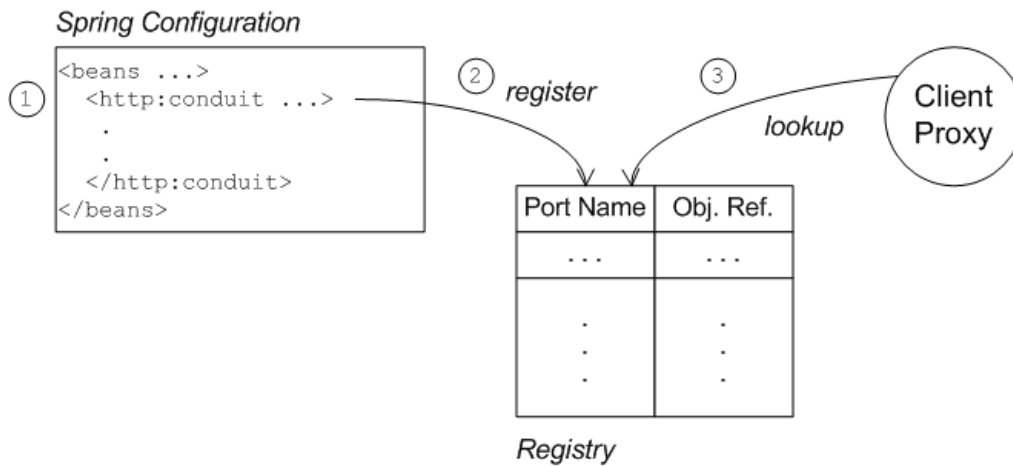
**Figure 6.3. Client Proxy Implicitly Configured by http:conduit Element**

The connection between the client proxy and the `http:conduit` element is established as follows:

1. The client loads and parses the Spring configuration file containing the `http:conduit` element.
2. When the `http:conduit` bean is created, a corresponding entry is created in the registry, which stores a reference to the bean under the specified WSDL port name (where the name is stored in QName format).
3. When the JAX-WS client proxy is created, it scans the registry to see if it can find a `http:conduit` bean associated with the proxy's WSDL port name. If it finds such a bean, it automatically injects the configuration details into the proxy.

## Certificates needed on the client side

The client is configured with the following `clientKeystore.jks` keystore file from the `src/main/resources/certs` directory. This keystore contains two entries, as follows:

### Trusted cert entry

A trusted certificate entry containing the CA certificate that issued and signed both the server certificate and the client certificate.

### Private key entry

A private key entry containing the client's own X.509 certificate and private key. In fact, this certificate is not strictly necessary to run the current example, because the server does not require the client to send a certificate during the TLS handshake (see [Example 6.2, "httpj:engine-factory Element with SSL/TLS Enabled"](#)).

## Loading Spring definitions into the client

The example client is not deployed directly into a Spring container, but it requires some Spring definitions in order to define a secure HTTP conduit. So how can you create the Spring definitions without a Spring container? It turns out that it is easy to read Spring definitions into a Java-based client using the `org.apache.cxf.bus.spring.SpringBusFactory` class.

The following code shows how to read Spring definitions from the file, `META-INF/spring/cxf-client.xml`, and create an Apache CXF Bus object that incorporates those definitions:

```
// Java
```

```
import org.apache.cxf.bus.spring.SpringBusFactory;
...
protected void startCxfBus() throws Exception {
    bf = new SpringBusFactory();
    Bus bus = bf.createBus("META-INF/spring/cxf-client.xml");
    bf.setDefaultBus(bus);
}
```

## Creating the client proxy

In principle, there are several different ways of creating a WSDL proxy: you could use the JAX-WS API to create a proxy based on the contents of a WSDL file; you could use the JAX-WS API to create a proxy *without* a WSDL file; or you could use the Apache CXF-specific class, **JaxWsProxyFactoryBean**, to create a proxy.

For this SSL/TLS client, the most convenient approach is to use the JAX-WS API to create a proxy without using a WSDL file, as shown in the following Java sample:

```
// Java
import javax.xml.ws.Service;
import org.apache.camel.example.reportincident.ReportIncidentEndpoint;
...
// create the webservice client and send the request
Service s = Service.create(SERVICE_NAME);
s.addPort(
    PORT_NAME,
    "http://schemas.xmlsoap.org/soap/",
    ADDRESS_URL
);
ReportIncidentEndpoint client =
    s.getPort(PORT_NAME, ReportIncidentEndpoint.class);
```



### NOTE

In this example, you *cannot* use the **JaxWsProxyFactoryBean** approach to create a proxy, because a proxy created in this way fails to find the HTTP conduit settings specified in the Spring configuration file.

The **SERVICE\_NAME** and **PORT\_NAME** constants are the QNames of the WSDL service and the WSDL port respectively, as defined in [Example 6.1, “The ReportIncidentEndpointService WSDL Service”](#). The **ADDRESS\_URL** string has the same value as the proxy Web service address and is defined as follows:

```
private static final String ADDRESS_URL =
    "https://localhost:9080/camel-example-cxf-proxy/webservices/incident";
```

In particular, note that the address *must* be defined with the URL scheme, **https**, which selects HTTP over SSL/TLS.

## Steps to add SSL/TLS security to the client

To define a JAX-WS client with SSL/TLS security enabled, perform the following steps:

1. [the section called “Create the Java client as a test case”](#).

2. the section called “Add the http:conduit element to Spring configuration”.
3. the section called “Run the client”.

## Create the Java client as a test case

[Example 6.3, “ReportIncidentRoutesTest Java client”](#) shows the complete code for a Java client that is implemented as a JUnit test case. This client replaces the existing test, `ReportIncidentRoutesTest.java`, in the `src/test/java/org/apache/camel/example/reportincident` sub-directory of the `examples/camel-example-cxf-proxy` demonstration.

To add the client to the `CamelInstallDir/examples/camel-example-cxf-proxy` demonstration, go to the `src/test/java/org/apache/camel/example/reportincident` sub-directory, move the existing `ReportIncidentRoutesTest.java` file to a backup location, then create a new `ReportIncidentRoutesTest.java` file and paste the code from [Example 6.3, “ReportIncidentRoutesTest Java client”](#) into this file.

### Example 6.3. ReportIncidentRoutesTest Java client

```
// Java
package org.apache.camel.example.reportincident;

import org.apache.camel.spring.Main;
import org.apache.cxf.jaxws.JaxWsProxyFactoryBean;
import org.junit.Test;

import java.net.URL;
import javax.xml.namespace.QName;
import javax.xml.ws.Service;

import org.apache.cxf.Bus;
import org.apache.cxf.bus.spring.SpringBusFactory;
import org.apache.camel.example.reportincident.ReportIncidentEndpoint;
import
org.apache.camel.example.reportincident.ReportIncidentEndpointService;

import static org.junit.Assert.assertEquals;

/**
 * Unit test of our routes
 */
public class ReportIncidentRoutesTest {

    private static final QName SERVICE_NAME
        = new QName("http://reportincident.example.camel.apache.org",
"ReportIncidentEndpointService");

    private static final QName PORT_NAME =
        new QName("http://reportincident.example.camel.apache.org",
"ReportIncidentEndpoint");

    private static final String WSDL_URL =
"file:src/main/resources/etc/report_incident.wsdl";
```

```

// should be the same address as we have in our route
private static final String ADDRESS_URL =
"https://localhost:9080/camel-example-cxf-proxy/webservices/incident";

protected SpringBusFactory bf;

protected void startCxfBus() throws Exception {
    bf = new SpringBusFactory();
    Bus bus = bf.createBus("META-INF/spring/cxf-client.xml");
    bf.setDefaultBus(bus);
}

@Test
public void testRendportIncident() throws Exception {
    startCxfBus();
    runTest();
}

protected void runTest() throws Exception {

    // create input parameter
    InputReportIncident input = new InputReportIncident();
    input.setIncidentId("123");
    input.setIncidentDate("2008-08-18");
    input.setGivenName("Claus");
    input.setFamilyName("Ibsen");
    input.setSummary("Bla");
    input.setDetails("Bla bla");
    input.setEmail("davsclaus@apache.org");
    input.setPhone("0045 2962 7576");

    // create the webservice client and send the request
    Service s = Service.create(SERVICE_NAME);
    s.addPort(PORT_NAME, "http://schemas.xmlsoap.org/soap/",
ADDRESS_URL);
    ReportIncidentEndpoint client = s.getPort(PORT_NAME,
ReportIncidentEndpoint.class);

    OutputReportIncident out = client.reportIncident(input);

    // assert we got a OK back
    assertEquals("OK;456", out.getCode());
}
}

```

## Add the http:conduit element to Spring configuration

[Example 6.4, “http:conduit Element with SSL/TLS Enabled”](#) shows the Spring configuration that defines a **http:conduit** element for the **ReportIncidentEndpoint** WSDL port. The **http:conduit** element is configured to enable SSL/TLS security for any client proxies that use the specified WSDL port.

To add the Spring configuration to the client test case, create the **src/test/resources/META-INF/spring** sub-directory, use your favorite text editor to create the file, **cxf-client.xml**, and then paste the contents of [Example 6.4, “http:conduit Element with SSL/TLS Enabled”](#) into the file.



**Example 6.4. http:conduit Element with SSL/TLS Enabled**

```

<?xml version="1.0" encoding="UTF-8"?>
<beans xmlns="http://www.springframework.org/schema/beans"
  xmlns:xsi="http://www.w3.org/2001/XMLSchema-instance"
  xmlns:cxf="http://camel.apache.org/schema/cxf"
  xmlns:sec="http://cxf.apache.org/configuration/security"
  xmlns:http="http://cxf.apache.org/transports/http/configuration"
  xsi:schemaLocation="
    http://www.springframework.org/schema/beans
    http://www.springframework.org/schema/beans/spring-beans.xsd
    http://camel.apache.org/schema/cxf
    http://camel.apache.org/schema/cxf/camel-cxf.xsd
    http://cxf.apache.org/configuration/security
    http://cxf.apache.org/schemas/configuration/security.xsd
    http://cxf.apache.org/transports/http/configuration
    http://cxf.apache.org/schemas/configuration/http-conf.xsd
  ">

  <http:conduit name="
{http://reportincident.example.camel.apache.org}ReportIncidentEndpoint.h
ttp-conduit">
    <http:tlsClientParameters disableCNCheck="true"
secureSocketProtocol="TLSv1">
        <sec:keyManagers keyPassword="ckpass">
            <sec:keyStore password="cspass" type="JKS"
                resource="certs/clientkeystore.jks" />
        </sec:keyManagers>
        <sec:trustManagers>
            <sec:keyStore password="cspass" type="JKS"
                resource="certs/clientkeystore.jks" />
        </sec:trustManagers>
        <sec:cipherSuitesFilter>
            <sec:include>.*_WITH_3DES.*</sec:include>
            <sec:include>.*_WITH_DES.*</sec:include>
            <sec:exclude>.*_WITH_NULL.*</sec:exclude>
            <sec:exclude>.*_DH_anon.*</sec:exclude>
        </sec:cipherSuitesFilter>
    </http:tlsClientParameters>
</http:conduit>

</beans>

```

Please note the following points about the preceding configuration:

- The **http:** and **sec:** namespace prefixes are needed to define the **http:conduit** element. In the **xsi:schemaLocation** element, it is also essential to specify the locations of the corresponding **http://cxf.apache.org/configuration/security** and **http://cxf.apache.org/transports/http/configuration** namespaces.
- The **disableCNCheck** attribute of the **http:tlsClientParameters** element is set to **true**. This means that the client does *not* check whether the Common Name in the server's X.509 certificate matches the server hostname. For more details, see [Appendix A, Managing Certificates](#).

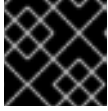
**IMPORTANT**

Disabling the CN check is *not* recommended in a production deployment.

- In the **sec:keystore** elements, the certificate locations are specified using the **resource** attribute, which finds the certificates on the classpath. When Maven runs the test, it automatically makes the contents of **src/main/resources** available on the classpath, so that the certificates can be read from the **src/main/resources/certs** directory.

**NOTE**

You also have the option of specifying a certificate location using the **file** attribute, which looks in the filesystem. But the **resource** attribute is more suitable for use with applications packaged in bundles.

- The **sec:cipherSuitesFilter** element is configured to exclude cipher suites matching **.\*\_WITH\_NULL\_.\*** and **.\*\_DH\_anon\_.\***. These cipher suites are effectively incomplete and are *not* intended for normal use.

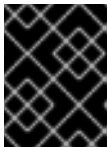
**IMPORTANT**

It is recommended that you always *exclude* the ciphers matching **.\*\_WITH\_NULL\_.\*** and **.\*\_DH\_anon\_.\***.

- The **secureSocketProtocol** attribute should be set to TLSv1, to match the server protocol and to ensure that the SSLv3 protocol is not used ([POODLE security vulnerability \(CVE-2014-3566\)](#)).

**Run the client**

Because the client is defined as a test case, you can run the client using the standard Maven test goal. To run the client, open a new command window, change directory to **CamelInstallDir/examples/camel-example-cxf-proxy**, and enter the following Maven command:

```
mvn test
```

If the test runs successfully, you should see the following output in the OSGi console window:

```
Incident was 123, changed to 456
Invoked real web service: id=456 by Claus Ibsen
```

# CHAPTER 7. LDAP AUTHENTICATION TUTORIAL

## Abstract

This tutorial explains how to set up an X.500 directory server and configure the OSGi container to use LDAP authentication.

## 7.1. TUTORIAL OVERVIEW

### Goals

In this tutorial you will:

- Install 389 Directory Server
- Add user entries to the LDAP server
- Add groups to manage security roles
- Configure JBoss Fuse to use LDAP authentication
- Configure JBoss Fuse to use roles for authorization
- Configure SSL/TLS connections to the LDAP server

## 7.2. SET-UP A DIRECTORY SERVER AND CONSOLE

### Overview

This stage of the tutorial explains how to install the X.500 directory server and the management console from the Fedora [389 Directory Server](#) project. If you already have access to a 389 Directory Server instance, you can skip the instructions for installing the 389 Directory Server and install the 389 Management Console instead.

### Prerequisites

If you are installing on a Red Hat Enterprise Linux platform, you must first install the [Extra Packages for Enterprise Linux \(EPEL\)](#). See the installation notes under [RHEL/Cent OS/ EPEL \( RHEL 6, RHEL 7, Cent OS 6, Cent OS 7\)](#) on the [fedoraproject.org](#) site.

### Install 389 Directory Server

If you do not have access to an existing *389 Directory Server* instance, you can install *389 Directory Server* on your local machine, as follows:

1. On Red Hat Enterprise Linux and Fedora platforms, use the standard **yum** package management utility to install *389 Directory Server*. Enter the following command at a command prompt (you must have administrator privileges on your machine):

```
sudo yum install 389-ds
```

**NOTE**

The required **389-ds** and **389-console** RPM packages are available for Fedora, RHEL6+EPEL, and CentOS7+EPEL platforms. At the time of writing, the **389-console** package is not yet available for RHEL 7.

2. After installing the 389 directory server packages, enter the following command to configure the directory server:

```
sudo setup-ds-admin.pl
```

The script is interactive and prompts you to provide the basic configuration settings for the 389 directory server. When the script is complete, it automatically launches the 389 directory server in the background.

3. For more details about how to install *389 Directory Server*, see the [Download](#) page.

## Install 389 Management Console

If you already have access to a *389 Directory Server* instance, you only need to install the 389 Management Console, which enables you to log in and manage the server remotely. You can install the 389 Management Console, as follows:

- *On Red Hat Enterprise Linux and Fedora platforms*—use the standard **yum** package management utility to install the 389 Management Console. Enter the following command at a command prompt (you must have administrator privileges on your machine):

```
sudo yum install 389-console
```

- *On Windows platforms*—see the [Windows Console](#) download instructions from [fedoraproject.org](http://fedoraproject.org).

## Connect the console to the server

To connect the 389 Directory Server Console to the LDAP server:

1. Enter the following command to start up the 389 Management Console:

```
389-console
```

2. A login dialog appears. Fill in the LDAP login credentials in the **User ID** and **Password** fields, and customize the hostname in the **Administration URL** field to connect to your 389 management server instance (port **9830** is the default port for the 389 management server instance).

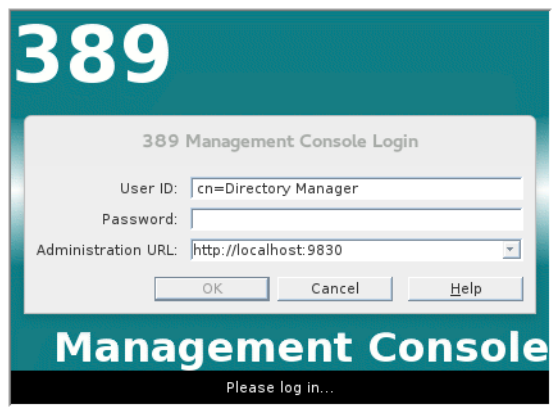

3. The 389 Management Console window appears. Select the **Servers and Applications** tab.
4. In the left-hand pane, drill down to the **Directory Server** icon.

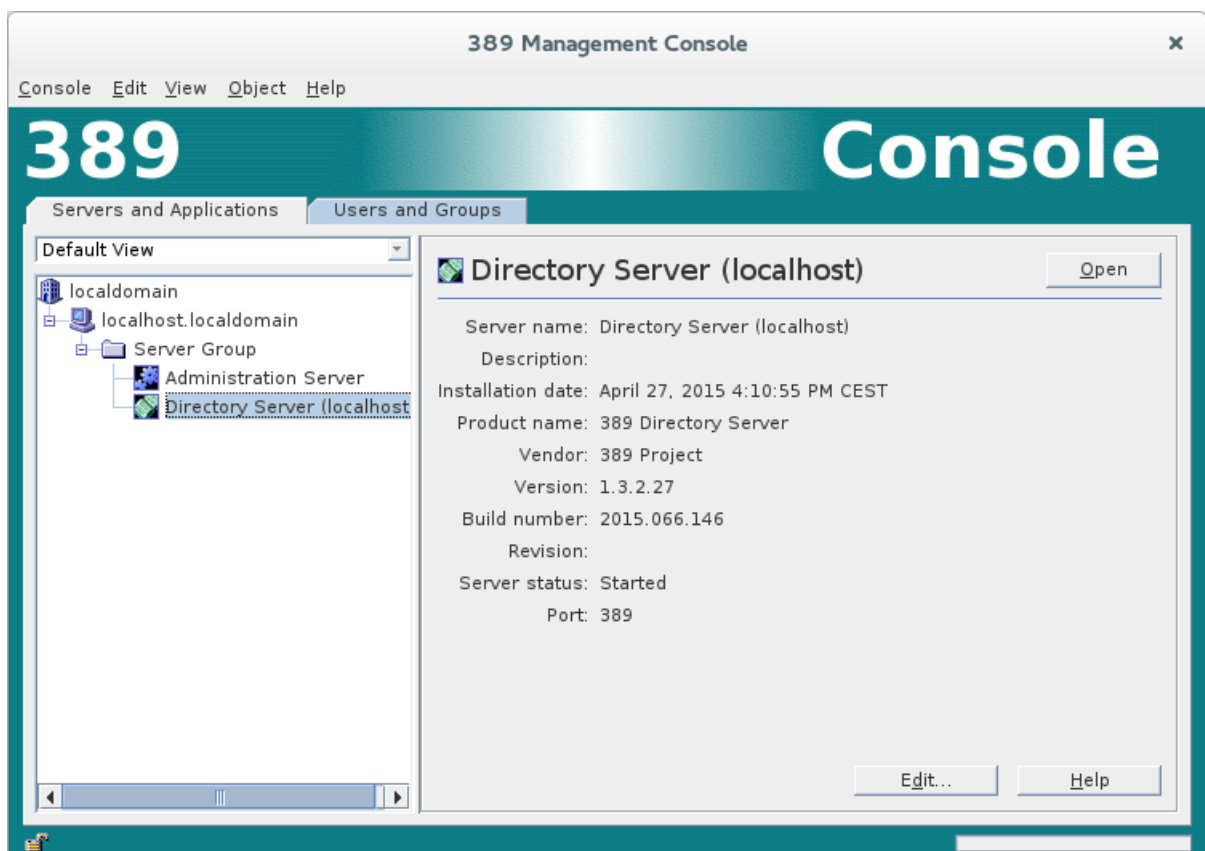

5. Select the **Directory Server** icon in the left-hand pane and click **Open**, to open the **389 Directory Server Console**.
6. In the **389 Directory Server Console**, click the **Directory** tab, to view the Directory Information Tree (DIT).
7. Expand the root node, **YourDomain** (usually named after a hostname, and shown as **localdomain** in the following screenshot), to view the DIT.

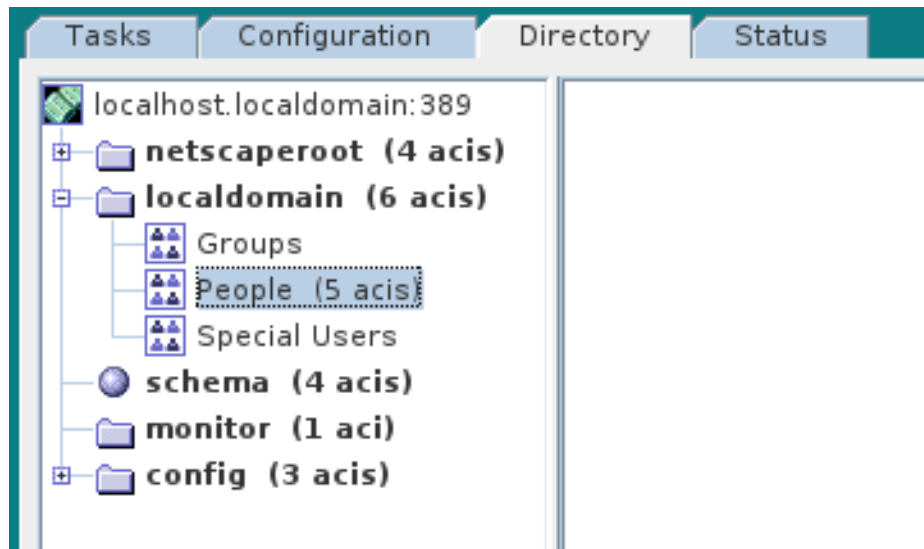

## 7.3. ADD USER ENTRIES TO THE DIRECTORY SERVER

### Overview

The basic prerequisite for using LDAP authentication with the OSGi container is to have an X.500 directory server running and configured with a collection of user entries. For many use cases, you will also want to configure a number of groups to manage user roles.

### Goals

In this portion of the tutorial you will

- [Add three user entries to the LDAP server](#)
- [Add four groups to the LDAP server](#)

### Adding user entries

Perform the following steps to add user entries to the directory server:

1. Ensure that the LDAP server and console are running. See [Section 7.2, “Set-up a Directory Server and Console”](#).
2. In the **Directory Server Console**, click on the **Directory** tab, and drill down to the **People** node, under the **YourDomain** node (where **YourDomain** is shown as **localdomain** in the following screenshots).

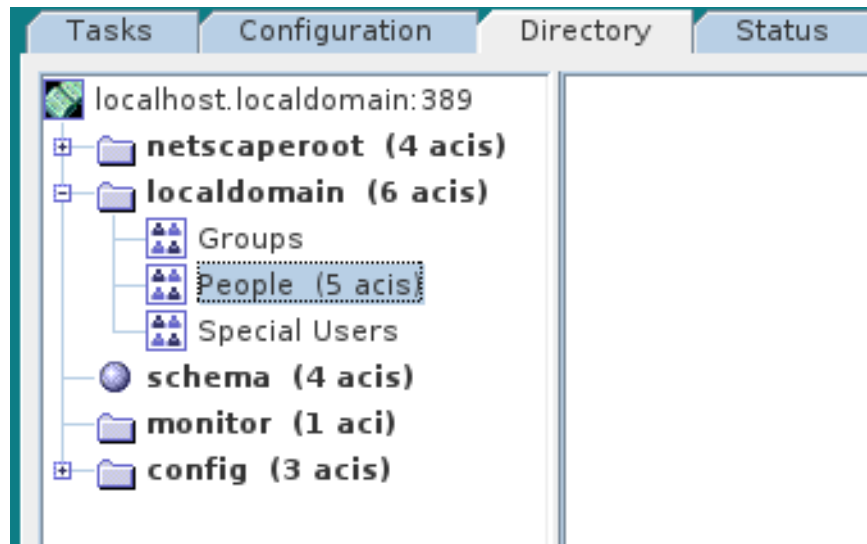

3. Right-click the **People** node, and select **New** → **User** from the context menu, to open the **Create New User** dialog.
4. Select the **User** tab in the left-hand pane of the **Create New User** dialog.
5. Fill in the fields of the **User** tab, as follows:
  - a. Set the **First Name** field to **John**.
  - b. Set the **Last Name** field to **Doe**.
  - c. Set the **User ID** field to **jdoe**.
  - d. Enter the password, **secret**, in the **Password** field.
  - e. Enter the password, **secret**, in the **Confirm Password** field.

6. Click **OK**.
7. Add a user **Jane Doe** by following [Step 3](#) to [Step 6](#).

In [Step 5.e](#), use **janedoe** for the new user's **User ID** and use the password, **secret**, for the password fields.

8. Add a user **Camel Rider** by following [Step 3](#) to [Step 6](#).

In [Step 5.e](#), use **crider** for the new user's **User ID** and use the password, **secret**, for the password fields.

## Adding groups for the roles

To add the groups that define the roles:

1. In the **Directory** tab of the **Directory Server Console**, drill down to the **Groups** node, under the **YourDomain** node.
2. Right-click the **Groups** node, and select **New** → **Group** from the context menu, to open the **Create New Group** dialog.
3. Select the **General** tab in the left-hand pane of the **Create New Group** dialog.
4. Fill in the fields of the **General** tab, as follows:
  - a. Set the **Group Name** field to **Administrator**.
  - b. Optionally, enter a description in the **Description** field.



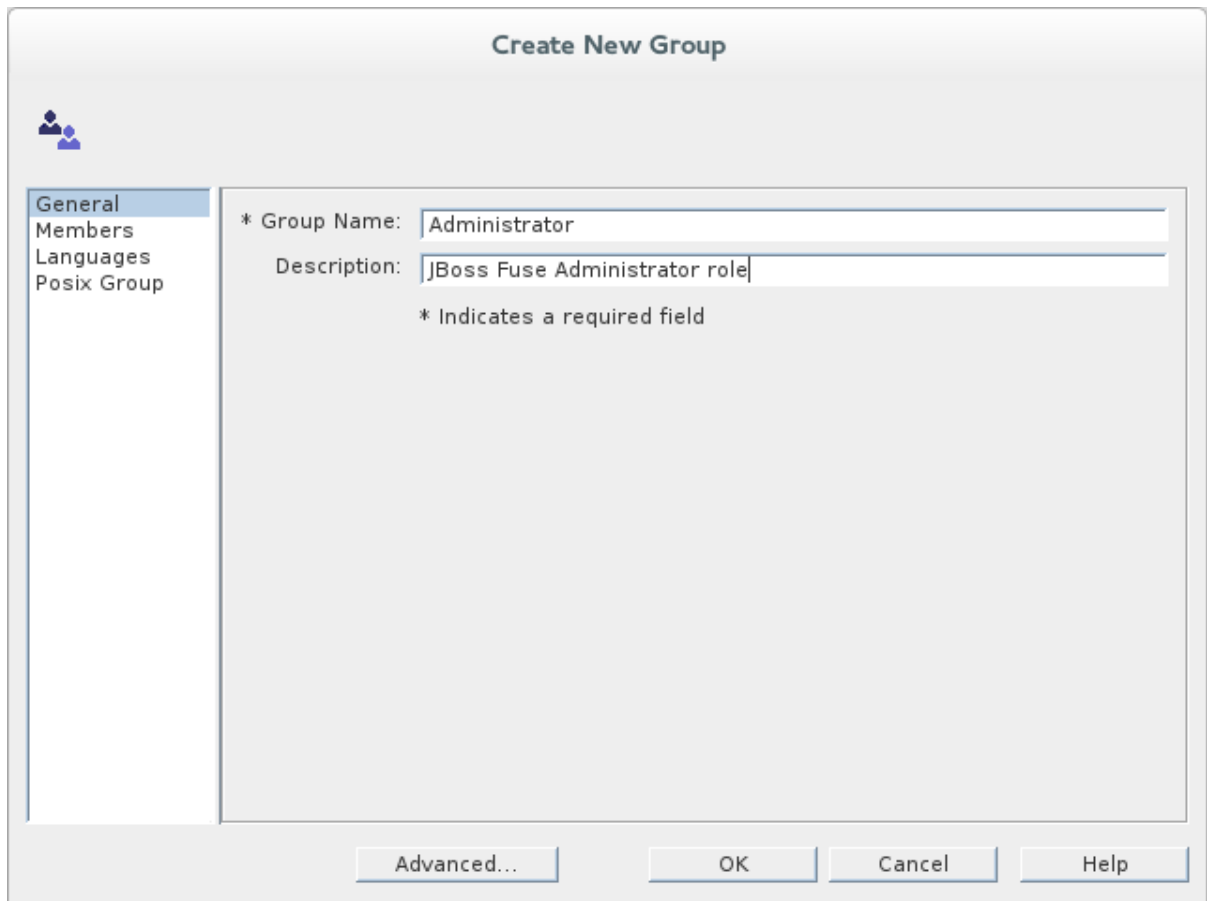

The screenshot shows the 'Create New Group' dialog box with the 'General' tab selected. The left-hand pane contains a list of tabs: General, Members, Languages, and Posix Group. The main area contains the following fields:

- \* Group Name: Administrator
- Description: JBoss Fuse Administrator role

\* Indicates a required field

Buttons at the bottom: Advanced..., OK, Cancel, Help

5. Select the **Members** tab in the left-hand pane of the **Create New Group** dialog.

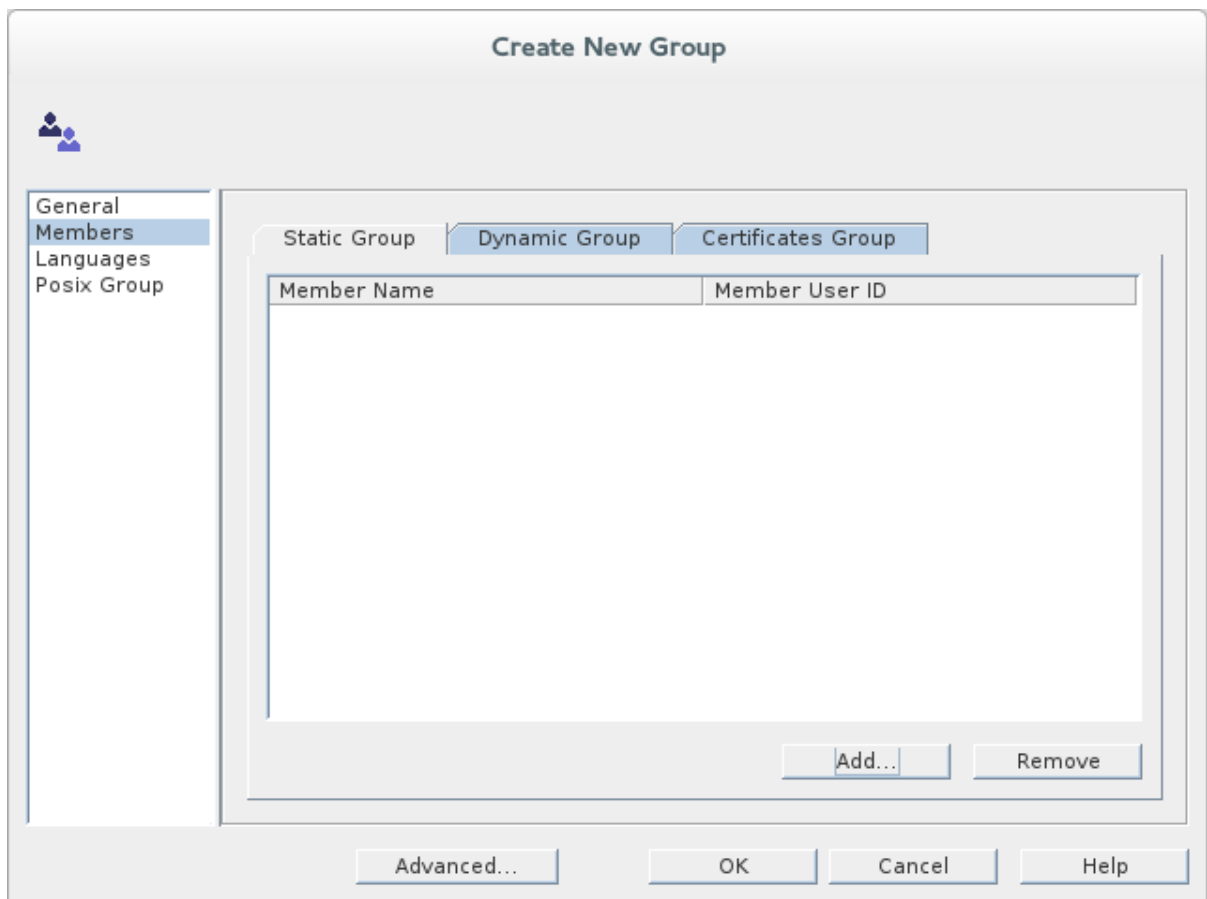

The screenshot shows the 'Create New Group' dialog box with the 'Members' tab selected. The left-hand pane contains a list of tabs: General, Members, Languages, and Posix Group. The main area contains the following elements:

- Static Group | Dynamic Group | Certificates Group
- Member Name | Member User ID
- Buttons: Add..., Remove

Buttons at the bottom: Advanced..., OK, Cancel, Help

6. Click **Add** to open the **Search users and groups** dialog.

- In the **Search** field, select **Users** from the drop-down menu, and click the **Search** button.

**Search users and groups**

Start searching from: ldap://localhost.localdomain:389/dc=localdomain

Search

for

Name	User ID	E-Mail	Phone
John Doe	jdoe		
Jane Doe	janedoe		
Camel Rider	crider		

- From the list of users that is now displayed, select **John Doe**.
- Click **OK**, to close the **Search users and groups** dialog.
- Click **OK**, to close the **Create New Group** dialog.
- Add a **Deployer** role by following [Step 2](#) to [Step 10](#).
  - In [Step 4](#), enter **Deployer** in the **Group Name** field.
  - In [Step 8](#), select **Jane Doe**.
- Add a **Monitor** role by following [Step 2](#) to [Step 10](#).
  - In [Step 4](#), enter **Monitor** in the **Group Name** field.
  - In [Step 8](#), select **Camel Rider**.

## 7.4. ENABLE LDAP AUTHENTICATION IN THE OSGI CONTAINER

### Overview

This section explains how to configure an LDAP realm in the OSGi container. The new realm overrides the default **karaf** realm, so that the container authenticates credentials based on user entries stored in the X.500 directory server.

### References

More detailed documentation is available on LDAP authentication, as follows:

- LDAPLoginModule options*—are described in detail in [Section 2.1.7](#), “[JAAS LDAP Login Module](#)”.

- *Configurations for other directory servers*—this tutorial covers only [389-DS](#). For details of how to configure other directory servers, such as Microsoft Active Directory, see [the section called “Filter settings for different directory servers”](#).

## Procedure for standalone OSGi container

To enable LDAP authentication in a standalone OSGi container:

1. Ensure that the X.500 directory server is running.
2. Start Red Hat JBoss Fuse by entering the following command in a terminal window:

```
./fuse
```

3. Create a file called `ldap-module.xml`.
4. Copy [Example 7.1, “JAAS Realm for Standalone”](#) into `ldap-module.xml`.

### Example 7.1. JAAS Realm for Standalone

```
<?xml version="1.0" encoding="UTF-8"?>
<blueprint xmlns="http://www.osgi.org/xmlns/blueprint/v1.0.0"
  xmlns:jaas="http://karaf.apache.org/xmlns/jaas/v1.0.0"
  xmlns:ext="http://aries.apache.org/blueprint/xmlns/blueprint-
ext/v1.0.0">

  <jaas:config name="karaf" rank="200">
    <jaas:module
      className="org.apache.karaf.jaas.modules.ldap.LDAPLoginModule"
      flags="required">
      initialContextFactory=com.sun.jndi.ldap.LdapCtxFactory
      connection.url=ldap://Hostname:Port
      connection.username=cn=Directory Manager
      connection.password=LDAPPASSWORD
      connection.protocol=
      user.base.dn=ou=People,dc=localdomain
      user.filter=(& (objectClass=inetOrgPerson)(uid=%u))
      user.search.subtree=true
      role.base.dn=ou=Groups,dc=localdomain
      role.name.attribute=cn
      role.filter=(uniquemember=%fqdn)
      role.search.subtree=true
      authentication=simple
    </jaas:module>
  </jaas:config>
</blueprint>
```

You must customize the following settings in the `ldap-module.xml` file:

#### connection.url

Set this URL to the actual location of your directory server instance. Normally, this URL has the format, `ldap://Hostname:Port`. For example, the default port for the 389 Directory Server is IP port **389**.

**connection.username**

Specifies the username that is used to authenticate the connection to the directory server. For 389 Directory Server, the default is usually **cn=Directory Manager**.

**connection.password**

Specifies the password part of the credentials for connecting to the directory server.

**authentication**

You can specify either of the following alternatives for the authentication protocol:

- **simple** implies that user credentials are supplied and you are obliged to set the **connection.username** and **connection.password** options in this case.
- **none** implies that authentication is *not* performed. There is no need to set the **connection.username** and **connection.password** options in this case.

This login module creates a JAAS realm called **karaf**, which is the same name as the default JAAS realm used by JBoss Fuse. By redefining this realm with a **rank** attribute value greater than **0**, it overrides the standard **karaf** realm which has the rank **0** (but note that in the context of Fabric, the default **karaf** realm has a rank of **99**, so you need to define a new realm with rank **100** or greater to override the default realm in a fabric).

For more details about how to configure JBoss Fuse to use LDAP, see [Section 2.1.7, “JAAS LDAP Login Module”](#).

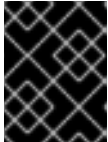
**IMPORTANT**

When setting the JAAS properties above, do *not* enclose the property values in double quotes.

5. To deploy the new LDAP module, copy the **ldap-module.xml** into the JBoss A-MQ **deploy/** directory.

The LDAP module is automatically activated.

**Procedure for a Fabric**

To enable LDAP authentication in a Fabric (affecting all of the containers in the current fabric):

1. Ensure that the X.500 directory server is running.
2. If your local Fabric container is not already running, start it now, by entering the following command in a terminal window:

```
./fuse
```

**NOTE**

If the Fabric container you want to connect to is running on a remote host, you can connect to it using the **client** command-line utility in the **InstallDir/bin** directory.

3. Create a new version of the Fabric profile data, by entering the following console command:

```
JBossFuse:karaf@root> version-create
Created version: 1.1 as copy of: 1.0
```

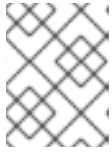

#### NOTE

In effect, this command creates a new branch named **1.1** in the Git repository underlying the ZooKeeper registry.

4. Create the new profile resource, **ldap-module.xml** (a Blueprint configuration file), in version **1.1** of the **default** profile, as follows:

```
JBossFuse:karaf@root> profile-edit --resource ldap-module.xml
default 1.1
```

The built-in profile editor opens automatically, which you can use to edit the contents of the **ldap-module.xml** resource.

5. Copy [Example 7.2, “JAAS Realm for Fabric”](#) into the **ldap-module.xml** resource, customizing the configuration properties, as necessary.

#### Example 7.2. JAAS Realm for Fabric

```
<?xml version="1.0" encoding="UTF-8"?>
<blueprint xmlns="http://www.osgi.org/xmlns/blueprint/v1.0.0"
  xmlns:jaas="http://karaf.apache.org/xmlns/jaas/v1.0.0"
  xmlns:ext="http://aries.apache.org/blueprint/xmlns/blueprint-
ext/v1.0.0">

  <jaas:config name="karaf" rank="200">
    <jaas:module
      className="org.apache.karaf.jaas.modules.ldap.LDAPLoginModule"
      flags="required">
      initialContextFactory=com.sun.jndi.ldap.LdapCtxFactory
      connection.url=ldap://Hostname:Port
      connection.username=cn=Directory Manager
      connection.password=LDAPPASSWORD
      connection.protocol=
      user.base.dn=ou=People,dc=localdomain
      user.filter=(&!(objectClass=inetOrgPerson)(uid=%u))
      user.search.subtree=true
      role.base.dn=ou=Groups,dc=localdomain
      role.name.attribute=cn
      role.filter=(uniquemember=%fqdn)
      role.search.subtree=true
      authentication=simple
    </jaas:module>
  </jaas:config>
</blueprint>
```

You must customize the following settings in the **ldap-module.xml** file:

**connection.url**

Set this URL to the actual location of your directory server instance. Normally, this URL has the format, **ldap://Hostname:Port**. You must be sure to use a hostname that is accessible to *all* of the containers in the fabric (hence, you cannot use **localhost** as the hostname here). The default port for the 389 Directory Server is IP port **389**.

**connection.username**

Specifies the username that is used to authenticate the connection to the directory server. For 389 Directory Server, the default is usually **cn=Directory Manager**.

**connection.password**

Specifies the password part of the credentials for connecting to the directory server.

**authentication**

You can specify either of the following alternatives for the authentication protocol:

- **simple** implies that user credentials are supplied and you are obliged to set the **connection.username** and **connection.password** options in this case.
- **none** implies that authentication is *not* performed. There is no need to set the **connection.username** and **connection.password** options in this case.

This login module creates a JAAS realm called **karaf**, which is the same name as the default JAAS realm used by Red Hat JBoss Fuse. By redefining this realm with a **rank** of **200**, it overrides all of the previously installed **karaf** realms (in the context of Fabric, you need to override the default **ZookeeperLoginModule**, which has a rank of **99**).

**IMPORTANT**

Pay particular attention to the value of the **rank** to ensure that it is higher than all previously installed **karaf** realms. If the **rank** is not sufficiently high, the new realm will not be used by the fabric.

**IMPORTANT**

When setting the JAAS properties above, do *not* enclose the property values in double quotes.

6. Save and close the **ldap-module.xml** resource by typing Ctrl-S and Ctrl-X.
7. Edit the agent properties of version 1.1 of the **default** profile, adding an instruction to deploy the Blueprint resource file defined in the previous step. Enter the following console command:

```
JBossFuse:karaf@root> profile-edit default 1.1
```

The built-in profile editor opens automatically. Add the following line to the agent properties:

```
bundle.ldap-realm=blueprint:profile:ldap-module.xml
```

Save and close the agent properties by typing Ctrl-S and Ctrl-X.

8. The new LDAP realm is not activated, until you upgrade a container to use the new version, **1.1**. To activate LDAP on a *single* container (for example, on a container called **root**), enter the following console command:

```
JBossFuse:karaf@root> container-upgrade 1.1 root
```

To activate LDAP on *all* containers in the fabric, enter the following console command:

```
JBossFuse:karaf@root> container-upgrade --all 1.1
```

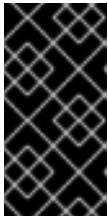

### IMPORTANT

It is advisable to upgrade just a single container initially, to make sure that everything is working properly. This is particularly important, if you have only remote access to the fabric: if you upgrade all of the containers at once, you might not be able to reconnect to the fabric.

9. To check that the LDAP realm is activated, enter the following console command:

```
JBossFuse:karaf@root> jaas-realms
Index Realm          Module Class
  1 karaf
org.apache.karaf.jaas.modules.ldap.LDAPLoginModule
```

If the output of this command lists the **ZookeeperLoginModule**, this means the LDAP realm is not yet activated. It might take a minute or so for activation of the LDAP realm to complete.

## Test the LDAP authentication

Test the new LDAP realm by connecting to the running container using the JBoss Fuse **client** utility, as follows:

1. Open a new command prompt.
2. Change directory to the JBoss Fuse **InstallDir/bin** directory.
3. Enter the following command to log on to the running container instance using the identity **jd**oe:

```
client -u jd
```

You should successfully log into the container's remote console. At the command console, type **jaas:** followed by the [Tab] key (to activate content completion):

```
JBossFuse:jd@root> jaas:
jaas:cancel          jaas:groupadd      jaas:groupcreate
jaas:groupdel       jaas:grouproleadd jaas:grouproledel
jaas:groups         jaas:manage       jaas:pending
jaas:realms         jaas:roleadd      jaas:roledel
jaas:update         jaas:useradd      jaas:userdel
jaas:users
```

You should see that **jd** has access to all of the **jaas** commands (which is consistent with the **Administrator** role).

4. Log off the remote console by entering the **logout** command.
5. Enter the following command to log on to the running container instance using the identity **janedoe**:

```
client -u janedoe -p secret
```

You should successfully log into the container's remote console. At the command console, type **jaas:** followed by the [Tab] key (to activate content completion):

```
JBossFuse:janedoe@root> jaas:
jaas:cancel          jaas:groupadd       jaas:groupcreate
jaas:groupdel       jaas:grouproleadd  jaas:grouproledele
jaas:groups         jaas:manage        jaas:pending
jaas:realms         jaas:roleadd       jaas:roledel
jaas:useradd        jaas:userdel       jaas:users
```

You should see that **janedoe** has access to almost all of the **jaas** commands, except for **jaas:update** (which is consistent with the **Deployer** role).

6. Log off the remote console by entering the **logout** command.
7. Enter the following command to log on to the running container instance using the identity **crider**:

```
client -u crider -p secret
```

You should successfully log into the container's remote console. At the command console, type **jaas:** followed by the [Tab] key (to activate content completion):

```
JBossFuse:janedoe@root> jaas:
jaas:groupcreate    jaas:groups        jaas:realms
```

You should see that **crider** has access to only three of the **jaas** commands (which is consistent with the **Monitor** role).

8. Log off the remote console by entering the **logout** command.

## 7.5. ENABLE SSL/TLS ON THE LDAP CONNECTION

### Overview

This tutorial explains how to enable SSL/TLS security on the connection between the LDAP login module and the Apache Directory Server.

The Apache Directory Server is already configured with an SSL endpoint. The default configuration creates an LDAPS endpoint that listens on the IP port **10636**. The directory server automatically generates a self-signed X.509 certificate which it uses to identify itself during the SSL/TLS handshake.





## IMPORTANT

You can use the default SSL configuration for simple demonstrations, but it is *not* suitable for real deployments. For advice on how to configure a real deployment, see [the section called “Tightening up security”](#).

## Procedure

To enable SSL/TLS security on the connection to the Apache Directory Server:

1. Obtain a copy of the server's self-signed certificate.
  - a. Using a Web browser , navigate to the following URL:

```
https://localhost:10636
```



## IMPORTANT

Remember to specify the scheme as **https**, not just **http**.

The Web browser now signals an error, because the certificate it receives from the server is untrusted. In the case of Firefox, you will see the following error in the browser window:

**Figure 7.1. Obtaining the Certificate**

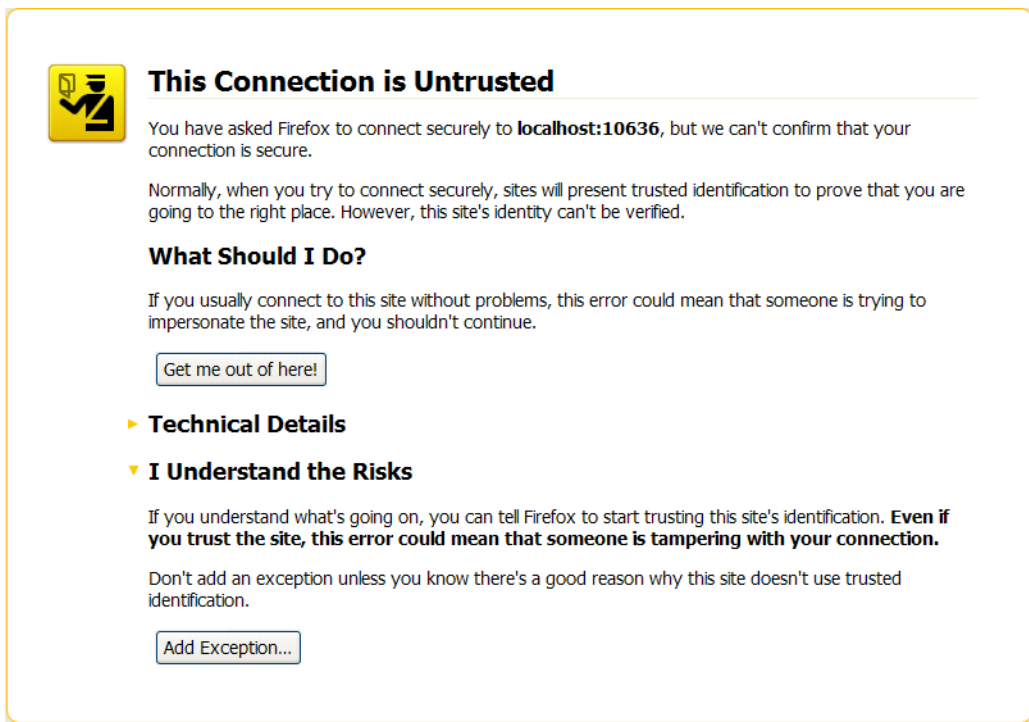

- b. Click **I Understand the Risks**.
- c. Click **Add Exception**.

The **Add Security Exception** dialog opens.

- d. In the **Add Security Exception** dialog, click **Get Certificate**.
- e. Click **View**.

The **Certificate Viewer** dialog opens.

- f. In the **Certificate Viewer** dialog, select the **Details** tab.
- g. Click **Export**.

The **Save Certificate To File** dialog opens.

- h. In the **Save Certificate To File** dialog, use the drop-down list to set the **Save as type** to X.509 Certificate (DER).
  - i. Save the certificate, **ApacheDS.der**, to a convenient location on the filesystem.
2. Convert the DER format certificate into a keystore.
    - a. From a command prompt, change directory to the directory where you have stored the **ApacheDS.der** file.
    - b. Enter the following **keytool** command:

```
keytool -import -file ApacheDS.der -alias server -keystore
truststore.ks -storepass secret
```

3. Copy the newly created keystore file, **truststore.ks**, into the JBoss Fuse **etc/** directory.
4. Open the **ldap-module.xml** file you created in [Section 7.4, "Enable LDAP Authentication in the OSGi Container"](#) in a text editor.
5. Edit the `connection.url` to use `ldaps://localhost:10636`.
6. Add the highlighted lines in [Example 7.3, "LDAP Configuration for Using SSL/TLS"](#).

### Example 7.3. LDAP Configuration for Using SSL/TLS

```
<?xml version="1.0" encoding="UTF-8"?>
<blueprint xmlns="http://www.osgi.org/xmlns/blueprint/v1.0.0"
  xmlns:jaas="http://karaf.apache.org/xmlns/jaas/v1.0.0"
  xmlns:ext="http://aries.apache.org/blueprint/xmlns/blueprint-
ext/v1.0.0">

  <!-- Example configuration for using LDAP based authentication.
  This example uses an JAAS LoginModule from Karaf.
  It supports authentication of users and also supports
  retrieving user roles for authorization.

  Note, this config overwrite the default karaf domain
  that is defined inside some JAR file
  by using a rank > 99 attribute.
  -->
  <jaas:config name="karaf" rank="200">
    <jaas:module
class="org.apache.karaf.jaas.modules.ldap.LDAPLoginModule"
flags="required">
      initialContextFactory=com.sun.jndi.ldap.LdapCtxFactory
      connection.username=uid=admin,ou=system
```

```

connection.password=secret
connection.protocol=
connection.url = ldaps://localhost:10636
user.base.dn = ou=users,ou=system
user.filter = (uid=%u)
user.search.subtree = true
role.base.dn = ou=users,ou=system
role.filter = (uid=%u)
role.name.attribute = ou
role.search.subtree = true
authentication = simple
ssl.protocol=TLSv1
ssl.truststore=truststore
ssl.algorithm=PKIX
</jaas:module>
</jaas:config>

<jaas:keystore name="truststore"
    path="file:///InstallDir/etc/truststore.ks"
keystorePassword="secret" />
</blueprint>

```

7. Copy the **ldap-module.xml** file into the Red Hat JBoss Fuse **deploy/** directory.

The LDAP module is automatically activated.

8. Test the new LDAP realm by connecting to the running container using the JBoss Fuse **client** utility.
  - a. Open a new command prompt.
  - b. Change to the JBoss Fuse install directory.
  - c. Enter the following command to log on to the running container instance using the identity **jd**oe:

```
client -u jd
```

You should successfully log into the container's remote console because **jd**oe does have the **admin** role.

## Tightening up security

The SSL set-up described here is suitable *only* as a proof-of-concept demonstration. For a real deployment, you must make the following changes to tighten up security:

- Delete all entries from the Red Hat JBoss Fuse's **etc/users.properties** file.

If the **ldap-module.xml** bundle fails to start up properly, JAAS authentication reverts to the built-in file-based **karaf** realm, which takes its user data from the **users.properties** file.

- Disable the insecure LDAP endpoint on the Apache Directory Server.
- Create and deploy a properly signed X.509 certificate on the Apache Directory Server.

See [Appendix A, \*Managing Certificates\*](#).

- Make sure that the LDAP server is configured to use the TLSv1 protocol (POODLE vulnerability). Do *not* enable the SSLv3 protocol. For more information, see [Poodle vulnerability \(CVE-2014-3566\)](#).

## Apache Directory Server Reference

For more details of how to configure SSL/TLS security on the Apache Directory Server, see [How to enable SSL](#).

# APPENDIX A. MANAGING CERTIFICATES

## Abstract

TLS authentication uses X.509 certificates—a common, secure and reliable method of authenticating your application objects. You can create X.509 certificates that identify your Red Hat JBoss Fuse applications.

## A.1. WHAT IS AN X.509 CERTIFICATE?

### Role of certificates

An X.509 certificate binds a name to a public key value. The role of the certificate is to associate a public key with the identity contained in the X.509 certificate.

### Integrity of the public key

Authentication of a secure application depends on the integrity of the public key value in the application's certificate. If an impostor replaces the public key with its own public key, it can impersonate the true application and gain access to secure data.

To prevent this type of attack, all certificates must be signed by a *certification authority* (CA). A CA is a trusted node that confirms the integrity of the public key value in a certificate.

### Digital signatures

A CA signs a certificate by adding its *digital signature* to the certificate. A digital signature is a message encoded with the CA's private key. The CA's public key is made available to applications by distributing a certificate for the CA. Applications verify that certificates are validly signed by decoding the CA's digital signature with the CA's public key.



#### WARNING

The supplied demonstration certificates are self-signed certificates. These certificates are insecure because anyone can access their private key. To secure your system, you must create new certificates signed by a trusted CA.

### Contents of an X.509 certificate

An X.509 certificate contains information about the certificate subject and the certificate issuer (the CA that issued the certificate). A certificate is encoded in Abstract Syntax Notation One (ASN.1), a standard syntax for describing messages that can be sent or received on a network.

The role of a certificate is to associate an identity with a public key value. In more detail, a certificate includes:

- A *subject distinguished name* (DN) that identifies the certificate owner.

- The *public key* associated with the subject.
- X.509 version information.
- A *serial number* that uniquely identifies the certificate.
- An *issuer DN* that identifies the CA that issued the certificate.
- The digital signature of the issuer.
- Information about the algorithm used to sign the certificate.
- Some optional X.509 v.3 extensions; for example, an extension exists that distinguishes between CA certificates and end-entity certificates.

## Distinguished names

A DN is a general purpose X.500 identifier that is often used in the context of security.

See [Appendix B, ASN.1 and Distinguished Names](#) for more details about DNs.

## A.2. CERTIFICATION AUTHORITIES

### A.2.1. Introduction to Certificate Authorities

A CA consists of a set of tools for generating and managing certificates and a database that contains all of the generated certificates. When setting up a system, it is important to choose a suitable CA that is sufficiently secure for your requirements.

There are two types of CA you can use:

- [commercial CAs](#) are companies that sign certificates for many systems.
- [private CAs](#) are trusted nodes that you set up and use to sign certificates for your system only.

### A.2.2. Commercial Certification Authorities

#### Signing certificates

There are several commercial CAs available. The mechanism for signing a certificate using a commercial CA depends on which CA you choose.

#### Advantages of commercial CAs

An advantage of commercial CAs is that they are often trusted by a large number of people. If your applications are designed to be available to systems external to your organization, use a commercial CA to sign your certificates. If your applications are for use within an internal network, a private CA might be appropriate.

#### Criteria for choosing a CA

Before choosing a commercial CA, consider the following criteria:

- What are the certificate-signing policies of the commercial CAs?

- Are your applications designed to be available on an internal network only?
- What are the potential costs of setting up a private CA compared to the costs of subscribing to a commercial CA?

### A.2.3. Private Certification Authorities

#### Choosing a CA software package

If you want to take responsibility for signing certificates for your system, set up a private CA. To set up a private CA, you require access to a software package that provides utilities for creating and signing certificates. Several packages of this type are available.

#### OpenSSL software package

One software package that allows you to set up a private CA is OpenSSL, <http://www.openssl.org>. The OpenSSL package includes basic command line utilities for generating and signing certificates. Complete documentation for the OpenSSL command line utilities is available at <http://www.openssl.org/docs>.

#### Setting up a private CA using OpenSSL

To set up a private CA, see the instructions in [Section A.5, “Creating Your Own Certificates”](#).

#### Choosing a host for a private certification authority

Choosing a host is an important step in setting up a private CA. The level of security associated with the CA host determines the level of trust associated with certificates signed by the CA.

If you are setting up a CA for use in the development and testing of Red Hat JBoss Fuse applications, use any host that the application developers can access. However, when you create the CA certificate and private key, do not make the CA private key available on any hosts where security-critical applications run.

#### Security precautions

If you are setting up a CA to sign certificates for applications that you are going to deploy, make the CA host as secure as possible. For example, take the following precautions to secure your CA:

- Do not connect the CA to a network.
- Restrict all access to the CA to a limited set of trusted users.
- Use an RF-shield to protect the CA from radio-frequency surveillance.

## A.3. CERTIFICATE CHAINING

### Certificate chain

A *certificate chain* is a sequence of certificates, where each certificate in the chain is signed by the subsequent certificate.

[Figure A.1, “A Certificate Chain of Depth 2”](#) shows an example of a simple certificate chain.

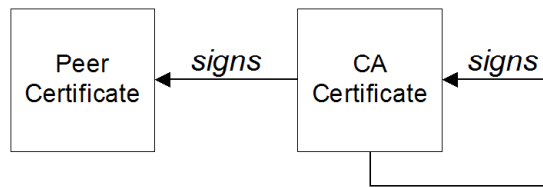
**Figure A.1. A Certificate Chain of Depth 2**

## Self-signed certificate

The last certificate in the chain is normally a *self-signed certificate*—a certificate that signs itself.

## Chain of trust

The purpose of a certificate chain is to establish a chain of trust from a peer certificate to a trusted CA certificate. The CA vouches for the identity in the peer certificate by signing it. If the CA is one that you trust (indicated by the presence of a copy of the CA certificate in your root certificate directory), this implies you can trust the signed peer certificate as well.

## Certificates signed by multiple CAs

A CA certificate can be signed by another CA. For example, an application certificate could be signed by the CA for the finance department of Progress Software, which in turn is signed by a self-signed commercial CA.

Figure A.2, “A Certificate Chain of Depth 3” shows what this certificate chain looks like.

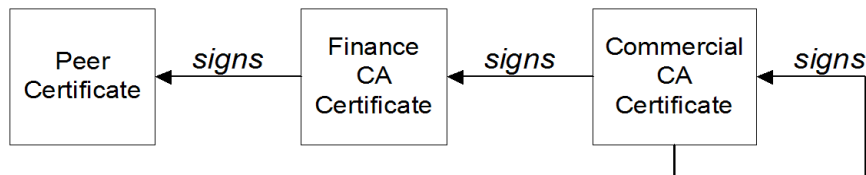
**Figure A.2. A Certificate Chain of Depth 3**

## Trusted CAs

An application can accept a peer certificate, provided it trusts at least one of the CA certificates in the signing chain.

## A.4. SPECIAL REQUIREMENTS ON HTTPS CERTIFICATES

### Overview

The HTTPS specification mandates that HTTPS clients must be capable of verifying the identity of the server. This can potentially affect how you generate your X.509 certificates. The mechanism for verifying the server identity depends on the type of client. Some clients might verify the server identity by accepting only those server certificates signed by a particular trusted CA. In addition, clients can inspect the contents of a server certificate and accept only the certificates that satisfy specific constraints.

In the absence of an application-specific mechanism, the HTTPS specification defines a generic mechanism, known as the *HTTPS URL integrity check*, for verifying the server identity. This is the standard mechanism used by Web browsers.



## HTTPS URL integrity check

The basic idea of the URL integrity check is that the server certificate's identity must match the server host name. This integrity check has an important impact on how you generate X.509 certificates for HTTPS: *the certificate identity (usually the certificate subject DN's common name) must match the host name on which the HTTPS server is deployed.*

The URL integrity check is designed to prevent *man-in-the-middle* attacks.

## Reference

The HTTPS URL integrity check is specified by RFC 2818, published by the Internet Engineering Task Force (IETF) at <http://www.ietf.org/rfc/rfc2818.txt>.

## How to specify the certificate identity

The certificate identity used in the URL integrity check can be specified in one of the following ways:

- [Using commonName](#)
- [Using subjectAltName](#)

### Using commonName

The usual way to specify the certificate identity (for the purpose of the URL integrity check) is through the Common Name (CN) in the subject DN of the certificate.

For example, if a server supports secure TLS connections at the following URL:

```
https://www.redhat.com/secure
```

The corresponding server certificate would have the following subject DN:

```
C=IE, ST=Co. Dublin, L=Dublin, O=RedHat,
OU=System, CN=www.redhat.com
```

Where the CN has been set to the host name, **www.redhat.com**.

For details of how to set the subject DN in a new certificate, see [Section A.5, “Creating Your Own Certificates”](#).

### Using subjectAltName (multi-homed hosts)

Using the subject DN's Common Name for the certificate identity has the disadvantage that only *one* host name can be specified at a time. If you deploy a certificate on a multi-homed host, however, you might find it is practical to allow the certificate to be used with *any* of the multi-homed host names. In this case, it is necessary to define a certificate with multiple, alternative identities, and this is only possible using the **subjectAltName** certificate extension.

For example, if you have a multi-homed host that supports connections to either of the following host names:

```
www.redhat.com
www.jboss.org
```

Then you can define a **subjectAltName** that explicitly lists both of these DNS host names. If you generate your certificates using the **openssl** utility, edit the relevant line of your **openssl.cnf** configuration file to specify the value of the **subjectAltName** extension, as follows:

```
subjectAltName=DNS:www.redhat.com,DNS:www.jboss.org
```

Where the HTTPS protocol matches the server host name against either of the DNS host names listed in the **subjectAltName** (the **subjectAltName** takes precedence over the Common Name).

The HTTPS protocol also supports the wildcard character, **\***, in host names. For example, you can define the **subjectAltName** as follows:

```
subjectAltName=DNS:*.jboss.org
```

This certificate identity matches any three-component host name in the domain **jboss.org**.



### WARNING

You must *never* use the wildcard character in the domain name (and you must take care never to do this accidentally by forgetting to type the dot, **.**, delimiter in front of the domain name). For example, if you specified **\*jboss.org**, your certificate could be used on *any* domain that ends in the letters **jboss**.

## A.5. CREATING YOUR OWN CERTIFICATES

### Abstract

This chapter describes the techniques and procedures to set up your own private Certificate Authority (CA) and to use this CA to generate and sign your own certificates.



### WARNING

Creating and managing your own certificates requires an expert knowledge of security. While the procedures described in this chapter can be convenient for generating your own certificates for demonstration and testing environments, it is *not recommended* to use these certificates in a production environment.

### A.5.1. Install the OpenSSL Utilities

#### Installing OpenSSL on RHEL and Fedora platforms

On Red Hat Enterprise Linux (RHEL) 5 and 6 and Fedora platforms, are made available as an RPM package. To install OpenSSL, enter the following command (executed with administrator privileges):

```
yum install openssl
```

## Source code distribution

The source distribution of OpenSSL is available from <http://www.openssl.org/docs>. The OpenSSL project provides source code distributions *only*. You cannot download a binary install of the OpenSSL utilities from the OpenSSL Web site.

## A.5.2. Set Up a Private Certificate Authority

### Overview

If you choose to use a private CA you need to generate your own certificates for your applications to use. The OpenSSL project provides free command-line utilities for setting up a private CA, creating signed certificates, and adding the CA to your Java keystore.



### WARNING

Setting up a private CA for a production environment requires a high level of expertise and extra care must be taken to protect the certificate store from external threats.

## Steps to set up a private Certificate Authority

To set up your own private Certificate Authority:

1. Create the directory structure for the CA, as follows:

```
X509CA/demoCA
X509CA/demoCA/private
X509CA/demoCA/certs
X509CA/demoCA/newcerts
X509CA/demoCA/cr1
```

2. Using a text editor, create the file, **X509CA/openssl.cfg**, and add the following contents to this file:

### Example A.1. OpenSSL Configuration

```
#
# SSLeay example configuration file.
# This is mostly being used for generation of certificate
# requests.
#
```

```

RANDFILE                = ./rnd

#####
##
[ req ]
default_bits            = 2048
default_keyfile         = keySS.pem
distinguished_name     = req_distinguished_name
encrypt_rsa_key        = yes
default_md              = sha1

[ req_distinguished_name ]
countryName             = Country Name (2 letter code)

organizationName       = Organization Name (eg, company)

commonName              = Common Name (eg, YOUR name)

#####
##
[ ca ]
default_ca              = CA_default          # The default ca section

#####
##
[ CA_default ]

dir                    = ./demoCA            # Where everything is
kept
certs                  = $dir/certs          # Where the issued
certs are kept
crl_dir                = $dir/crl           # Where the issued crl
are kept
database               = $dir/index.txt     # database index file.
#unique_subject        = no                 # Set to 'no' to
allow creation of                                           # several
certificates with same subject.
new_certs_dir          = $dir/newcerts      # default place for
new certs.

certificate             = $dir/cacert.pem    # The CA certificate
serial                 = $dir/serial        # The current serial
number
crl                    = $dir/crl.pem       # The current CRL
private_key             = $dir/private/cakey.pem # The private key
RANDFILE               = $dir/private/.rand # private random
number file

name_opt                = ca_default        # Subject Name
options
cert_opt                = ca_default        # Certificate field
options

default_days           = 365                # how long to certify
for

```

```

default_crl_days    = 30                # how long before next
CRL
default_md          = md5              # which md to use.
preserve           = no               # keep passed DN
ordering

policy              = policy_anything

[ policy_anything ]
countryName        = optional
stateOrProvinceName = optional
localityName       = optional
organizationName   = optional
organizationalUnitName = optional
commonName         = supplied
emailAddress       = optional

```



### IMPORTANT

The preceding **openssl.cfg** configuration file is provided *as a demonstration only*. In a production environment, this configuration file would need to be carefully elaborated by an engineer with a high level of security expertise, and actively maintained to protect against evolving security threats.

3. Initialize the **demoCA/serial** file, which must have the initial contents **01** (zero one). Enter the following command:

```
echo 01 > demoCA/serial
```

4. Initialize the **demoCA/index.txt**, which *must* initially be completely empty. Enter the following command:

```
touch demoCA/index.txt
```

5. Create a new self-signed CA certificate and private key with the command:

```
openssl req -x509 -new -config openssl.cfg -days 365 -out
demoCA/cacert.pem -keyout demoCA/private/cakey.pem
```

You are prompted for a pass phrase for the CA private key and details of the CA distinguished name as shown in [Example A.2, “Creating a CA Certificate”](#).

### Example A.2. Creating a CA Certificate

```

Generating a 2048 bit RSA private key
.....
.....+++
.....+++
writing new private key to 'demoCA/private/cakey.pem'
Enter PEM pass phrase:
Verifying - Enter PEM pass phrase:
-----

```

```

You are about to be asked to enter information that will be
incorporated
into your certificate request.
What you are about to enter is what is called a Distinguished Name
or a DN.
There are quite a few fields but you can leave some blank
For some fields there will be a default value,
If you enter '.', the field will be left blank.
-----
Country Name (2 letter code) []:DE
Organization Name (eg, company) []:Red Hat
Common Name (eg, YOUR name) []:Scooby Doo

```

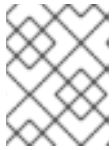

## NOTE

The security of the CA depends on the security of the private key file and the private key pass phrase used in this step.

You must ensure that the file names and location of the CA certificate and private key, **cacert.pem** and **cakey.pem**, are the same as the values specified in **openssl.cfg**.

### A.5.3. Create a CA Trust Store File

#### Overview

A trust store file is commonly required on the client side of an SSL/TLS connection, in order to verify a server's identity. A trust store file can also be used to check digital signatures (for example, to check that a signature was made using the private key corresponding to one of the trusted certificates in the trust store file).

#### Steps to create a CA trust store

To add one or more CA certificates to a trust store file:

1. Assemble the collection of trusted CA certificates that you want to deploy.

The trusted CA certificates can be obtained from public CAs or private CAs. The trusted CA certificates can be in any format that is compatible with the Java **keystore** utility; for example, PEM format. All you need are the certificates themselves—the private keys and passwords are *not* required.

2. Add a CA certificate to the trust store using the **keytool -import** command.

Enter the following command to add the CA certificate, **cacert.pem**, in PEM format, to a JKS trust store.

```

keytool -import -file cacert.pem -alias CAAlias -keystore
truststore.ts -storepass StorePass

```

Where **truststore.ts** is a keystore file containing CA certificates. If this file does not already exist, the **keytool** command creates it. The **CAAlias** is a convenient identifier for the imported CA certificate and **StorePass** is the password required to access the keystore file.

- Repeat the previous step to add all of the CA certificates to the trust store.

## A.5.4. Generate and Sign a New Certificate

### Overview

In order for a certificate to be useful in the real world, it must be signed by a CA, which vouches for the authenticity of the certificate. This facilitates a scalable solution for certificate verification, because it means that a single CA certificate can be used to verify a large collection of certificates.

### Steps to generate and sign a new certificate

To generate and sign a new certificate, using your own private CA, perform the following steps:

- Generate a certificate and private key pair using the **keytool -genkeypair** command, as follows:

```
keytool -genkeypair -dname "CN=Alice, OU=Engineering, O=Red Hat,
ST=Dublin, C=IE" -validity 365 -alias alice -keypass KeyPass -
keystore alice.ks -storepass StorePass
```

Because the specified keystore, **alice.ks**, did not exist prior to issuing the command implicitly creates a new keystore and sets its password to **StorePass**.

The **-dname** and **-validity** flags define the contents of the newly created X.509 certificate.



#### NOTE

When specifying the certificate's Distinguished Name (through the **-dname** parameter), you must be sure to observe any policy constraints specified in the **openssl.cfg** file. If those policy constraints are not heeded, you will not be able to sign the certificate using the CA (in the next steps).

- Create a certificate signing request using the **keytool -certreq** command.

Create a new certificate signing request for the **alice.ks** certificate and export it to the **alice\_csr.pem** file, as follows:

```
keytool -certreq -alias alice -file alice_csr.pem -keypass KeyPass -
keystore alice.ks -storepass StorePass
```

- Sign the CSR using the **openssl ca** command.

Sign the CSR for the Alice certificate, using your private CA, as follows:

```
openssl ca -config openssl.cfg -days 365 -in alice_csr.pem -out
alice_signed.pem
```

You will be prompted to enter the CA private key pass phrase you used when creating the CA (in [Step 5](#)).

For more details about the **openssl ca** command see <http://www.openssl.org/docs/apps/ca.html#>.

4. Convert the signed certificate to PEM only format using the **openssl x509** command with the **-outform** option set to **PEM**. Enter the following command:

```
openssl x509 -in alice_signed.pem -out alice_signed.pem -outform PEM
```

5. Concatenate the CA certificate file and the converted, signed certificate file to form a certificate chain. For example, on Linux and UNIX platforms, you can concatenate the CA certificate file and the signed Alice certificate, **alice\_signed.pem**, as follows:

```
cat demoCA/cacert.pem alice_signed.pem > alice.chain
```

6. Import the new certificate's full certificate chain into the Java keystore using the **keytool -import** command. Enter the following command:

```
keytool -import -file alice.chain -keypass KeyPass -keystore  
alice.ks -storepass StorePass
```



## APPENDIX B. ASN.1 AND DISTINGUISHED NAMES

### Abstract

The OSI Abstract Syntax Notation One (ASN.1) and X.500 Distinguished Names play an important role in the security standards that define X.509 certificates and LDAP directories.

### B.1. ASN.1

#### Overview

The *Abstract Syntax Notation One* (ASN.1) was defined by the OSI standards body in the early 1980s to provide a way of defining data types and structures that are independent of any particular machine hardware or programming language. In many ways, ASN.1 can be considered a forerunner of modern interface definition languages, such as the OMG's IDL and WSDL, which are concerned with defining platform-independent data types.

ASN.1 is important, because it is widely used in the definition of standards (for example, SNMP, X.509, and LDAP). In particular, ASN.1 is ubiquitous in the field of security standards. The formal definitions of X.509 certificates and distinguished names are described using ASN.1 syntax. You do not require detailed knowledge of ASN.1 syntax to use these security standards, but you need to be aware that ASN.1 is used for the basic definitions of most security-related data types.

#### BER

The OSI's Basic Encoding Rules (BER) define how to translate an ASN.1 data type into a sequence of octets (binary representation). The role played by BER with respect to ASN.1 is, therefore, similar to the role played by GIOP with respect to the OMG IDL.

#### DER

The OSI's Distinguished Encoding Rules (DER) are a specialization of the BER. The DER consists of the BER plus some additional rules to ensure that the encoding is unique (BER encodings are not).

#### References

You can read more about ASN.1 in the following standards documents:

- ASN.1 is defined in X.208.
- BER is defined in X.209.

### B.2. DISTINGUISHED NAMES

#### Overview

Historically, distinguished names (DN) are defined as the primary keys in an X.500 directory structure. However, DNs have come to be used in many other contexts as general purpose identifiers. In Apache CXF, DNs occur in the following contexts:

- X.509 certificates—for example, one of the DNs in a certificate identifies the owner of the certificate (the security principal).
- LDAP—DNs are used to locate objects in an LDAP directory tree.

## String representation of DN

Although a DN is formally defined in ASN.1, there is also an LDAP standard that defines a UTF-8 string representation of a DN (see [RFC 2253](#)). The string representation provides a convenient basis for describing the structure of a DN.



### NOTE

The string representation of a DN does *not* provide a unique representation of DER-encoded DN. Hence, a DN that is converted from string format back to DER format does not always recover the original DER encoding.

## DN string example

The following string is a typical example of a DN:

```
c=US,o=IONA Technologies,ou=Engineering,cn=A. N. Other
```

## Structure of a DN string

A DN string is built up from the following basic elements:

- [OID](#) .
- [Attribute Types](#) .
- [AVA](#) .
- [RDN](#) .

## OID

An OBJECT IDENTIFIER (OID) is a sequence of bytes that uniquely identifies a grammatical construct in ASN.1.

## Attribute types

The variety of attribute types that can appear in a DN is theoretically open-ended, but in practice only a small subset of attribute types are used. [Table B.1, “Commonly Used Attribute Types”](#) shows a selection of the attribute types that you are most likely to encounter:

**Table B.1. Commonly Used Attribute Types**

String Representation	X.500 Attribute Type	Size of Data	Equivalent OID
C	countryName	2	2.5.4.6
O	organizationName	1...64	2.5.4.10

String Representation	X.500 Attribute Type	Size of Data	Equivalent OID
OU	organizationalUnitName	1..64	2.5.4.11
CN	commonName	1..64	2.5.4.3
ST	stateOrProvinceName	1..64	2.5.4.8
L	localityName	1..64	2.5.4.7
STREET	streetAddress		
DC	domainComponent		
UID	userid		

## AVA

An *attribute value assertion* (AVA) assigns an attribute value to an attribute type. In the string representation, it has the following syntax:

```
<attr-type>=<attr-value>
```

For example:

```
CN=A. N. Other
```

Alternatively, you can use the equivalent OID to identify the attribute type in the string representation (see [Table B.1, “Commonly Used Attribute Types”](#)). For example:

```
2.5.4.3=A. N. Other
```

## RDN

A *relative distinguished name* (RDN) represents a single node of a DN (the bit that appears between the commas in the string representation). Technically, an RDN might contain more than one AVA (it is formally defined as a set of AVAs). However, this almost never occurs in practice. In the string representation, an RDN has the following syntax:

```
<attr-type>=<attr-value>[+<attr-type>=<attr-value> ...]
```

Here is an example of a (very unlikely) multiple-value RDN:

```
OU=Eng1+OU=Eng2+OU=Eng3
```

Here is an example of a single-value RDN:

OU=Engineering

## INDEX

### A

Abstract Syntax Notation One (see ASN.1)

ASN.1, [Contents of an X.509 certificate](#), [ASN.1 and Distinguished Names](#)

attribute types, [Attribute types](#)

AVA, [AVA](#)

OID, [OID](#)

RDN, [RDN](#)

attribute value assertion (see AVA)

AVA, [AVA](#)

### B

Basic Encoding Rules (see BER)

BER, [BER](#)

### C

CA, [Integrity of the public key](#)

choosing a host, [Choosing a host for a private certification authority](#)

commercial CAs, [Commercial Certification Authorities](#)

list of trusted, [Trusted CAs](#)

multiple CAs, [Certificates signed by multiple CAs](#)

private CAs, [Private Certification Authorities](#)

security precautions, [Security precautions](#)

certificates

chaining, [Certificate chain](#)

peer, [Chain of trust](#)

public key, [Contents of an X.509 certificate](#)

self-signed, [Self-signed certificate](#)

signing, [Integrity of the public key](#)

X.509, [Role of certificates](#)

chaining of certificates, [Certificate chain](#)

---

## D

DER, [DER](#)

Distinguished Encoding Rules (see DER)

distinguished names  
definition, [Overview](#)

## DN

definition, [Overview](#)  
string representation, [String representation of DN](#)

## J

### JAAS

configuration syntax, [Configuring a JAAS realm](#)  
converting to blueprint, [Converting standard JAAS login properties to XML](#)  
namespace, [Namespace](#)

jaas:config, [Configuring a JAAS realm](#)

jaas:module, [Configuring a JAAS realm](#)

JMX SSL connection, enabling, [Enabling Remote JMX SSL](#)

## M

multiple CAs, [Certificates signed by multiple CAs](#)

## O

OpenSSL, [OpenSSL software package](#)

## P

peer certificate, [Chain of trust](#)

public keys, [Contents of an X.509 certificate](#)

## R

RDN, [RDN](#)

relative distinguished name (see RDN)

root certificate directory, [Trusted CAs](#)

## S

self-signed certificate, [Self-signed certificate](#)

signing certificates, [Integrity of the public key](#)

SSLey, [OpenSSL software package](#)

T

trusted CAs, [Trusted CAs](#)

X

X.500, [ASN.1 and Distinguished Names](#)

X.509 certificate

definition, [Role of certificates](#)