



Red Hat OpenStack Platform 16.0

Bare Metal Provisioning

Install, Configure, and Use the Bare Metal Service (Ironic)

Red Hat OpenStack Platform 16.0 Bare Metal Provisioning

Install, Configure, and Use the Bare Metal Service (Ironic)

OpenStack Team
rhos-docs@redhat.com

Legal Notice

Copyright © 2020 Red Hat, Inc.

The text of and illustrations in this document are licensed by Red Hat under a Creative Commons Attribution–Share Alike 3.0 Unported license ("CC-BY-SA"). An explanation of CC-BY-SA is available at

<http://creativecommons.org/licenses/by-sa/3.0/>

. In accordance with CC-BY-SA, if you distribute this document or an adaptation of it, you must provide the URL for the original version.

Red Hat, as the licensor of this document, waives the right to enforce, and agrees not to assert, Section 4d of CC-BY-SA to the fullest extent permitted by applicable law.

Red Hat, Red Hat Enterprise Linux, the Shadowman logo, the Red Hat logo, JBoss, OpenShift, Fedora, the Infinity logo, and RHCE are trademarks of Red Hat, Inc., registered in the United States and other countries.

Linux[®] is the registered trademark of Linus Torvalds in the United States and other countries.

Java[®] is a registered trademark of Oracle and/or its affiliates.

XFS[®] is a trademark of Silicon Graphics International Corp. or its subsidiaries in the United States and/or other countries.

MySQL[®] is a registered trademark of MySQL AB in the United States, the European Union and other countries.

Node.js[®] is an official trademark of Joyent. Red Hat is not formally related to or endorsed by the official Joyent Node.js open source or commercial project.

The OpenStack[®] Word Mark and OpenStack logo are either registered trademarks/service marks or trademarks/service marks of the OpenStack Foundation, in the United States and other countries and are used with the OpenStack Foundation's permission. We are not affiliated with, endorsed or sponsored by the OpenStack Foundation, or the OpenStack community.

All other trademarks are the property of their respective owners.

Abstract

This guide provides procedures for installing, configuring, and using the Bare Metal service in the overcloud of a Red Hat OpenStack Platform environment.

Table of Contents

PREFACE	4
CHAPTER 1. ABOUT THE BARE METAL SERVICE	5
CHAPTER 2. PLANNING FOR BARE METAL PROVISIONING	7
2.1. INSTALLATION ASSUMPTIONS	7
2.2. HARDWARE REQUIREMENTS	7
2.3. NETWORKING REQUIREMENTS	7
2.3.1. The Default Bare Metal Network	8
2.3.2. The Custom Composable Network	9
CHAPTER 3. DEPLOYING AN OVERCLOUD WITH THE BARE METAL SERVICE	10
3.1. CREATING THE IRONIC TEMPLATE	10
3.2. CONFIGURING THE UNDERCLOUD FOR BARE METAL PROVISIONING OVER IPV6	10
3.3. NETWORK CONFIGURATION	12
3.3.1. Configuring a custom IPv4 provisioning network	12
3.3.2. Configuring a custom IPv6 provisioning network	13
3.4. EXAMPLE TEMPLATES	16
3.5. ENABLING IRONIC INTROSPECTION IN THE OVERCLOUD	16
3.6. DEPLOYING THE OVERCLOUD	17
3.7. TESTING THE BARE METAL SERVICE	17
CHAPTER 4. CONFIGURING FOR THE BARE METAL SERVICE AFTER DEPLOYMENT	19
4.1. CONFIGURING OPENSTACK NETWORKING	19
4.1.1. Configuring OpenStack Networking to Communicate with the Bare Metal Service on a flat Bare Metal Network	19
4.1.2. Configuring OpenStack Networking to Communicate with the Bare Metal Service on a Custom Composable Bare Metal Network	20
4.2. CONFIGURING NODE CLEANING	21
4.2.1. Manual Node Cleaning	21
4.3. CREATING THE BARE METAL FLAVOR	22
4.4. CREATING THE BARE METAL IMAGES	22
4.4.1. Preparing the Deploy Images	23
4.4.2. Preparing the User Image	23
4.4.3. Disk image environment variables	23
4.4.4. Installing the User Image	24
4.5. CONFIGURING DEPLOY INTERFACES	25
4.5.1. Understanding the deploy process	26
Prerequisites	26
Workflow	26
4.5.2. Configuring the direct deploy interface on the overcloud	27
Procedure	27
4.6. ADDING PHYSICAL MACHINES AS BARE METAL NODES	28
4.6.1. Enrolling a Bare Metal Node With an Inventory File	28
4.6.2. Enrolling a Bare Metal Node Manually	30
4.7. CONFIGURING REDFISH VIRTUAL MEDIA BOOT	33
4.7.1. Deploying a bare metal server with Redfish virtual media boot	33
4.8. USING HOST AGGREGATES TO SEPARATE PHYSICAL AND VIRTUAL MACHINE PROVISIONING	35
CHAPTER 5. ADMINISTERING BARE METAL NODES	37
5.1. LAUNCHING AN INSTANCE USING THE COMMAND LINE INTERFACE	37
5.2. LAUNCH AN INSTANCE USING THE DASHBOARD	37
5.3. CONFIGURE PORT GROUPS IN THE BARE METAL PROVISIONING SERVICE	38

5.3.1. Configure the Switches	38
5.3.2. Configure Port Groups in the Bare Metal Provisioning Service	39
5.4. DETERMINING THE HOST TO IP ADDRESS MAPPING	39
5.5. ATTACHING AND DETACHING A VIRTUAL NETWORK INTERFACE	41
5.6. CONFIGURING NOTIFICATIONS FOR THE BARE METAL SERVICE	43
5.7. CONFIGURING AUTOMATIC POWER FAULT RECOVERY	44
5.8. INTROSPECTING OVERCLOUD NODES	45
CHAPTER 6. BOOTING FROM CINDER VOLUMES	46
6.1. CINDER VOLUME BOOT FOR BARE METAL NODES	46
6.2. CONFIGURING NODES FOR CINDER VOLUME BOOT	46
6.3. CONFIGURING ISCSI KERNEL PARAMETERS ON THE BOOT DISK	46
6.4. CREATING AND USING A BOOT VOLUME IN CINDER	50
CHAPTER 7. ML2 NETWORKING-ANSIBLE	52
7.1. MODULAR LAYER 2 (ML2) NETWORKING-ANSIBLE	52
7.2. NETWORKING REQUIREMENTS FOR NETWORKING-ANSIBLE	52
7.3. OPENSTACK BARE METAL (IRONIC) REQUIREMENTS FOR NETWORKING-ANSIBLE	53
7.4. ENABLING NETWORKING-ANSIBLE ML2 FUNCTIONALITY	53
7.5. CONFIGURING NETWORKS FOR NETWORKING-ANSIBLE	55
7.5.1. Configuring networks for networking-ansible in access mode	56
7.5.2. Configuring ports for bare metal guests in access mode	56
7.5.3. Configuring networks for networking-ansible in trunk mode	57
7.5.4. Configuring ports for bare metal guests in trunk mode	58
7.6. TESTING NETWORKING-ANSIBLE ML2 FUNCTIONS	58
CHAPTER 8. TROUBLESHOOTING THE BARE METAL SERVICE	60
8.1. PXE BOOT ERRORS	60
8.2. LOGIN ERRORS AFTER THE BARE METAL NODE BOOTS	61
8.3. THE BARE METAL SERVICE IS NOT GETTING THE RIGHT HOSTNAME	62
8.4. INVALID OPENSTACK IDENTITY SERVICE CREDENTIALS WHEN EXECUTING BARE METAL SERVICE COMMANDS	62
8.5. HARDWARE ENROLLMENT	62
8.6. NO VALID HOST ERRORS	62
8.7. TROUBLESHOOTING IDRAC ISSUES	63
APPENDIX A. BARE METAL DRIVERS	65
A.1. INTELLIGENT PLATFORM MANAGEMENT INTERFACE (IPMI)	65
A.2. REDFISH	65
A.3. DELL REMOTE ACCESS CONTROLLER (DRAC)	65
A.4. INTEGRATED REMOTE MANAGEMENT CONTROLLER (IRMC)	66
A.5. INTEGRATED LIGHTS-OUT (ILO)	66
A.6. CONVERTING TO NEXT GENERATION POWER MANAGEMENT DRIVERS	67

PREFACE

This document provides instructions for installing and configuring the Bare Metal service (ironic) in the overcloud, and using the service to provision and manage physical machines for end users.

The Bare Metal service components are also used by the Red Hat OpenStack Platform director, as part of the undercloud, to provision and manage the bare metal nodes that make up the OpenStack environment (the overcloud). For more information about how the director uses the Bare Metal service, see the [Director Installation and Usage](#) guide.

CHAPTER 1. ABOUT THE BARE METAL SERVICE

The OpenStack Bare Metal service (ironic) provides the components required to provision and manage physical machines for end users. The Bare Metal service in the overcloud interacts with the following OpenStack services:

- OpenStack Compute (nova) provides scheduling, tenant quotas, IP assignment, and a user-facing API for virtual machine instance management, while the Bare Metal service provides the administrative API for hardware management.
- OpenStack Identity (keystone) provides request authentication and assists the Bare Metal service in locating other OpenStack services.
- OpenStack Image service (glance) manages images and image metadata.
- OpenStack Networking (neutron) provides DHCP and network configuration.
- OpenStack Object Storage (swift) is used by certain drivers to expose temporary URLs to images.

The Bare Metal service uses iPXE to provision physical machines. The following diagram outlines how the OpenStack services interact during the provisioning process when a user launches a new machine with the default drivers.

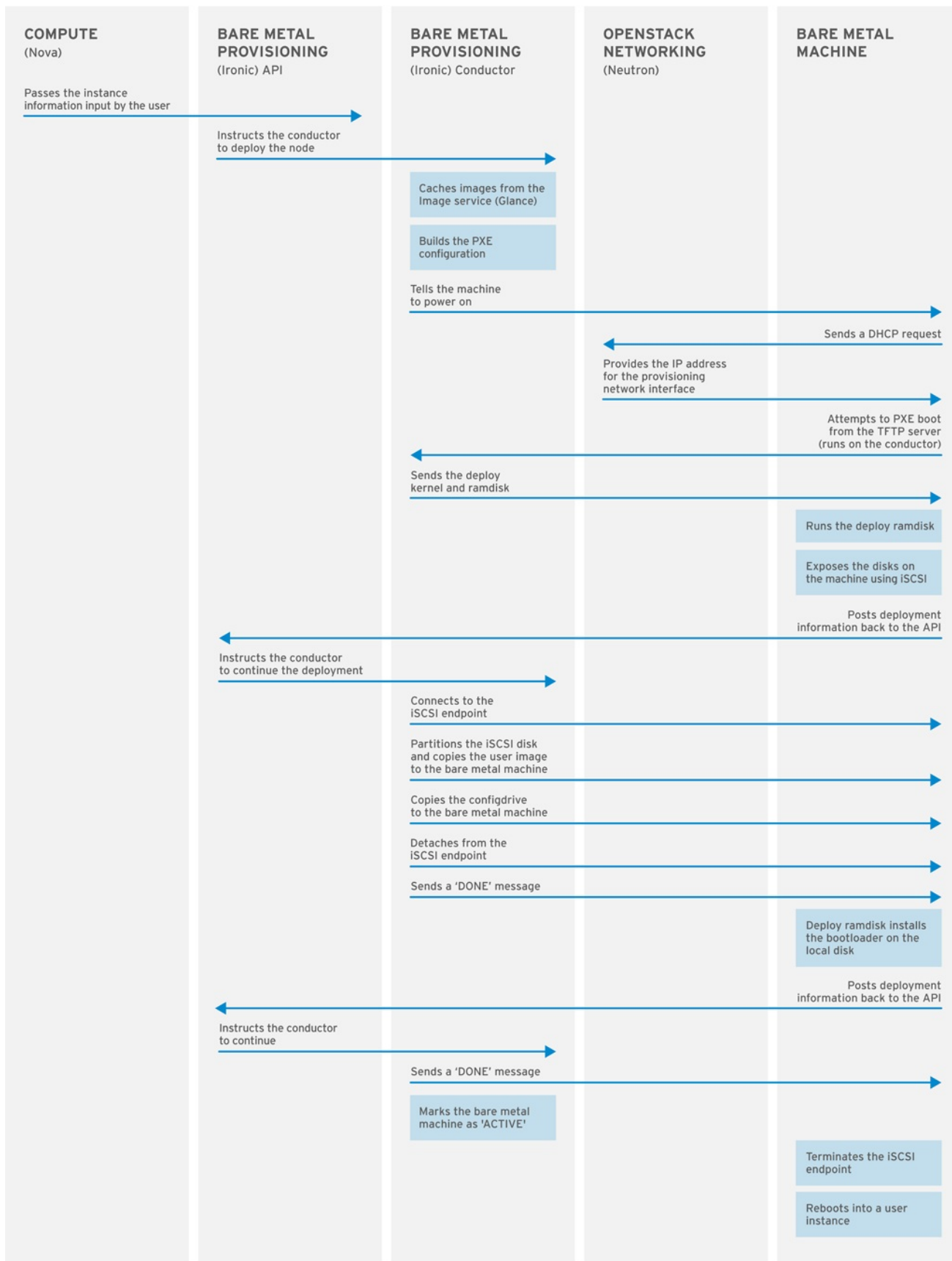

OPENSTACK_377593_1215

CHAPTER 2. PLANNING FOR BARE METAL PROVISIONING

This chapter outlines the requirements for configuring the Bare Metal service, including installation assumptions, hardware requirements, and networking requirements.

2.1. INSTALLATION ASSUMPTIONS

This guide assumes that you have installed the director on the undercloud node, and are ready to install the Bare Metal service along with the rest of the overcloud. For more information on installing the director, see [Installing the Undercloud](#).



NOTE

The Bare Metal service in the overcloud is designed for a trusted tenant environment, as the bare metal nodes have direct access to the control plane network of your OpenStack installation. If you implement a custom composable network for Ironic services in the overcloud, users do not need to access the control plane.

2.2. HARDWARE REQUIREMENTS

Overcloud Requirements

The hardware requirements for an overcloud with the Bare Metal service are the same as for the standard overcloud. For more information, see [Overcloud Requirements](#) in the *Director Installation and Usage* guide.

Bare Metal Machine Requirements

The hardware requirements for bare metal machines that will be provisioned vary depending on the operating system you are installing.

- For Red Hat Enterprise Linux 8, see the [Red Hat Enterprise Linux 8 Performing a standard RHEL installation](#).
- For Red Hat Enterprise Linux 7, see the [Red Hat Enterprise Linux 7 Installation Guide](#).
- For Red Hat Enterprise Linux 6, see the [Red Hat Enterprise Linux 6 Installation Guide](#).

All bare metal machines that you want to provision require the following:

- A NIC to connect to the bare metal network.
- A power management interface (for example, IPMI) connected to a network reachable from the **ironic-conductor** service. By default, **ironic-conductor** runs on all of the controller nodes, unless you are using composable roles and running **ironic-conductor** elsewhere.
- PXE boot on the bare metal network. Disable PXE boot on all other NICs in the deployment.

2.3. NETWORKING REQUIREMENTS

The bare metal network:

This is a private network that the Bare Metal service uses for the following operations:

- The provisioning and management of bare metal machines on the overcloud.

- Cleaning bare metal nodes before and between deployments.
- Tenant access to the bare metal nodes.

The bare metal network provides DHCP and PXE boot functions to discover bare metal systems. This network must use a native VLAN on a trunked interface so that the Bare Metal service can serve PXE boot and DHCP requests.

You can configure the bare metal network in two ways:

- Use a flat bare metal network for Ironic Conductor services. This network must route to the Ironic services on the control plane. If you define an isolated bare metal network, the bare metal nodes cannot PXE boot.
- Use a custom composable network to implement Ironic services in the overcloud.



NOTE

The Bare Metal service in the overcloud is designed for a trusted tenant environment, as the bare metal nodes have direct access to the control plane network of your OpenStack installation. If you implement a custom composable network for Ironic services in the overcloud, users do not need to access the control plane.

Network tagging:

- The control plane network (the director's provisioning network) is always untagged.
- The bare metal network must be untagged for provisioning, and must also have access to the Ironic API.
- Other networks may be tagged.

Overcloud controllers:

The controller nodes with the Bare Metal service must have access to the bare metal network.

Bare metal nodes:

The NIC which the bare metal node is configured to PXE-boot from must have access to the bare metal network.

2.3.1. The Default Bare Metal Network

In this architecture, the bare metal network is separated from the control plane network. The bare metal network is a flat network that also acts as the tenant network.

- The bare metal network is created by the OpenStack operator. This network requires a route to the director provisioning network.
- Ironic users have access to the public OpenStack APIs, and to the bare metal network. Since the bare metal network is routed to the director's provisioning network, users also have indirect access to the control plane.
- Ironic uses the bare metal network for node cleaning.

Default bare metal network architecture diagram

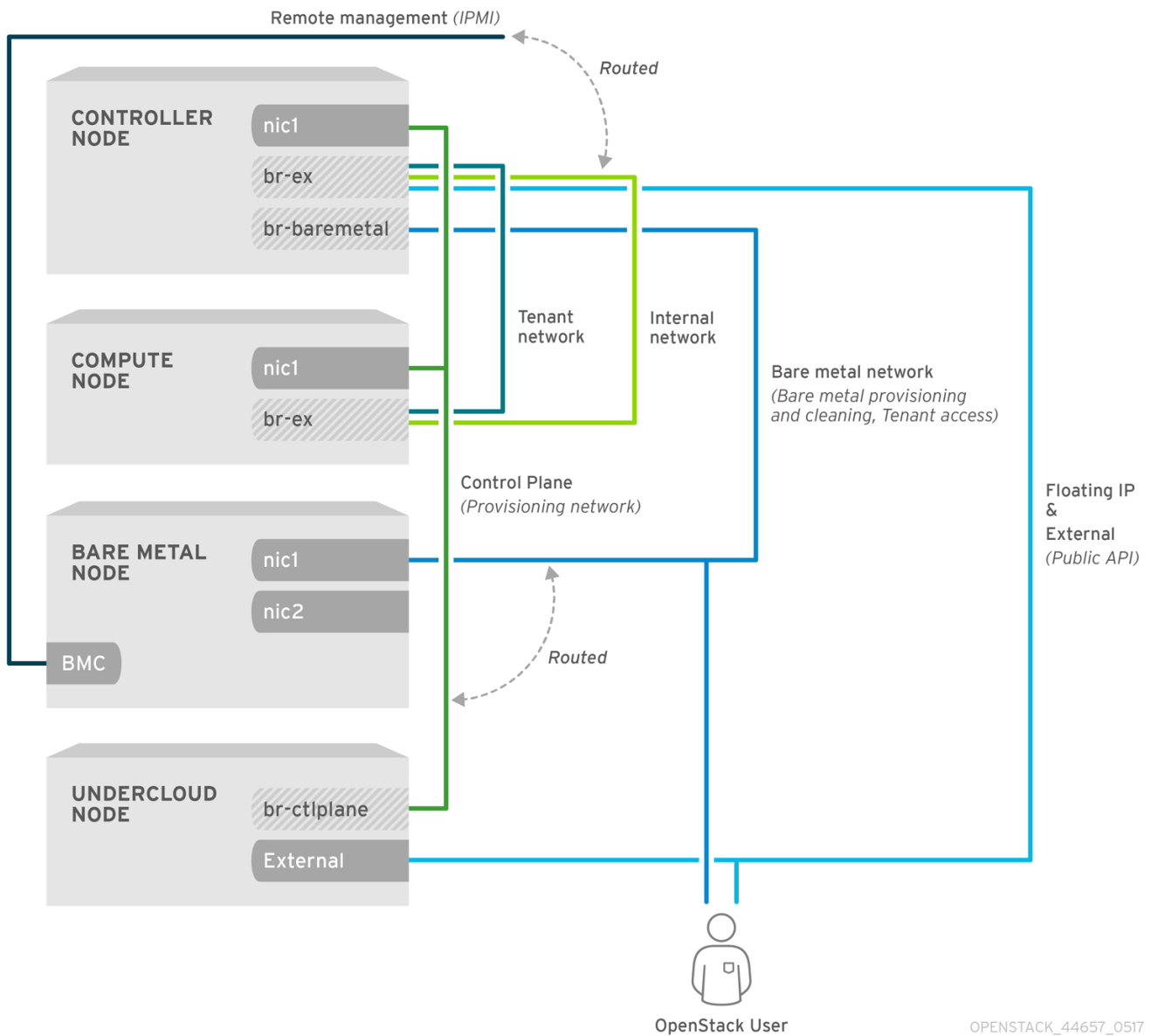

2.3.2. The Custom Composable Network

In this architecture, the bare metal network is a custom composable network that does not have access to the control plane. Creating this network might be preferable if you want to limit access to the control plane.

- The custom composable bare metal network is created by the OpenStack operator.
- Ironic users have access to the public OpenStack APIs, and to the custom composable bare metal network.
- Ironic uses the custom composable bare metal network for node cleaning. :leveloffset: +1

CHAPTER 3. DEPLOYING AN OVERCLOUD WITH THE BARE METAL SERVICE

For full details about overcloud deployment with the director, see [Director Installation and Usage](#). This chapter covers only the deployment steps specific to ironic.

3.1. CREATING THE IRONIC TEMPLATE

Use an environment file to deploy the overcloud with the Bare Metal service enabled. A template is located on the director node at `/usr/share/openstack-tripleo-heat-templates/environments/services/ironic-overcloud.yaml`.

Filling in the template

Additional configuration can be specified either in the provided template or in an additional yaml file, for example `~/templates/ironic.yaml`.

- For a hybrid deployment with both bare metal and virtual instances, you must add **AggregateInstanceExtraSpecsFilter** to the list of **NovaSchedulerDefaultFilters**. If you have not set **NovaSchedulerDefaultFilters** anywhere, you can do so in `ironic.yaml`. For an example, see [Section 3.4, "Example Templates"](#).



NOTE

If you are using SR-IOV, `NovaSchedulerDefaultFilters` is already set in `tripleo-heat-templates/environments/neutron-sriov.yaml`. Append **AggregateInstanceExtraSpecsFilter** to this list.

- The type of cleaning that occurs before and between deployments is set by **IronicCleaningDiskErase**. By default, this is set to 'full' by `deployment/ironic/ironic-conductor-container-puppet.yaml`. Setting this to 'metadata' can substantially speed up the process, as it cleans only the partition table, however, since the deployment will be less secure in a multi-tenant environment, you should do this only in a trusted tenant environment.
- You can add drivers with the **IronicEnabledDrivers** parameter. By default, `ipmi`, `idrac` and `ilo` are enabled.

For a full list of configuration parameters, see [Bare Metal](#) in the *Overcloud Parameters* guide.

3.2. CONFIGURING THE UNDERCLOUD FOR BARE METAL PROVISIONING OVER IPV6

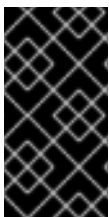

IMPORTANT

This feature is available in this release as a *Technology Preview*, and therefore is not fully supported by Red Hat. It should only be used for testing, and should not be deployed in a production environment. For more information about Technology Preview features, see [Scope of Coverage Details](#).

If you have IPv6 nodes and infrastructure, you can configure the undercloud and the provisioning network to use IPv6 instead of IPv4 so that director can provision and deploy Red Hat OpenStack Platform onto IPv6 nodes. However, there are some considerations:

- Stateful DHCPv6 is available only with a limited set of UEFI firmware. For more information, see [Bugzilla #1575026](#).
- Dual stack IPv4/6 is not available.
- Tempest validations might not perform correctly.
- IPv4 to IPv6 migration is not available during upgrades.

Modify the **undercloud.conf** file to enable IPv6 provisioning in Red Hat OpenStack Platform.

Prerequisites

- An IPv6 address on the undercloud. For more information, see [Configuring an IPv6 address on the undercloud](#) in the *IPv6 Networking for the Overcloud* guide.

Procedure

1. Copy the sample **undercloud.conf** file, or modify your existing **undercloud.conf** file.
2. Set the following parameter values in the **undercloud.conf** file:
 - a. Set **ipv6_address_mode** to **dhcpv6-stateless** or **dhcpv6-stateful** if your NIC supports stateful DHCPv6 with Red Hat OpenStack Platform. For more information about stateful DHCPv6 availability, see [Bugzilla #1575026](#).
 - b. Set **enable_routed_networks** to **true** if you do not want the undercloud to create a router on the provisioning network. In this case, the data center router must provide router advertisements. Otherwise, set this value to **false**.
 - c. Set **local_ip** to the IPv6 address of the undercloud.
 - d. Use IPv6 addressing for the undercloud interface parameters **undercloud_public_host** and **undercloud_admin_host**.
 - e. In the **[ctlplane-subnet]** section, use IPv6 addressing in the following parameters:
 - **cidr**
 - **dhcp_start**
 - **dhcp_end**
 - **gateway**
 - **inspection_iprange**
 - f. In the **[ctlplane-subnet]** section, set an IPv6 nameserver for the subnet in the **dns_nameservers** parameter.

```

ipv6_address_mode = dhcpv6-stateless
enable_routed_networks: false
local_ip = <ipv6-address>
undercloud_admin_host = <ipv6-address>
undercloud_public_host = <ipv6-address>

[ctlplane-subnet]
```

```
cidr = <ipv6-address>::<ipv6-mask>
dhcp_start = <ipv6-address>
dhcp_end = <ipv6-address>
dns_nameservers = <ipv6-dns>
gateway = <ipv6-address>
inspection_iprange = <ipv6-address>,<ipv6-address>
```

3.3. NETWORK CONFIGURATION

If you use the default flat bare metal network, you must create a bridge **br-baremetal** for ironic to use. You can specify this in an additional template:

~/templates/network-environment.yaml

```
parameter_defaults:
  NeutronBridgeMappings: datacentre:br-ex,baremetal:br-baremetal
  NeutronFlatNetworks: datacentre,baremetal
```

You can configure this bridge either in the provisioning network (control plane) of the controllers, so that you can reuse this network as the bare metal network, or add a dedicated network. The configuration requirements are the same, however the bare metal network cannot be VLAN-tagged, as it is used for provisioning.

~/templates/nic-configs/controller.yaml

```
network_config:
  -
    type: ovs_bridge
    name: br-baremetal
    use_dhcp: false
    members:
      -
        type: interface
        name: eth1
```



NOTE

The Bare Metal service in the overcloud is designed for a trusted tenant environment, as the bare metal nodes have direct access to the control plane network of your OpenStack installation.

3.3.1. Configuring a custom IPv4 provisioning network

The default flat provisioning network can introduce security concerns in a customer environment as a tenant can interfere with the undercloud network. To prevent this risk, you can configure a custom composable bare metal provisioning network for ironic services that does not have access to the control plane:

1. Configure the shell to access Identity as the administrative user:

```
$ source ~/stackrc
```

2. Copy the **network_data.yaml** file:

```
(undercloud) [stack@host01 ~]$ cp /usr/share/openstack-tripleo-heat-templates/network_data.yaml .
```

3. Edit the new **network_data.yaml** file and add a new network for IPv4 overcloud provisioning:

```
# custom network for overcloud provisioning
- name: OcProvisioning
  name_lower: oc_provisioning
  vip: true
  vlan: 205
  ip_subnet: '172.23.3.0/24'
  allocation_pools: [{'start': '172.23.3.10', 'end': '172.23.3.200'}]
```

4. Update the **network_environments.yaml** and **nic-configs/controller.yaml** files to use the new network.

- a. In the **network_environments.yaml** file, remap Ironic networks:

```
ServiceNetMap:
  IronicApiNetwork: oc_provisioning
  IronicNetwork: oc_provisioning
```

- b. In the **nic-configs/controller.yaml** file, add an interface and necessary parameters:

```
$network_config:
- type: vlan
  vlan_id:
    get_param: OcProvisioningNetworkVlanID
  addresses:
- ip_netmask:
    get_param: OcProvisioningIpSubnet
```

5. Copy the **roles_data.yaml** file:

```
(undercloud) [stack@host01 ~]$ cp /usr/share/openstack-tripleo-heat-templates/roles_data.yaml .
```

6. Edit the new **roles_data.yaml** and add the new network for the controller:

```
networks:
...
OcProvisioning:
  subnet: oc_provisioning_subnet
```

7. Include the new **network_data.yaml** and **roles_data.yaml** files in the deploy command:

```
-n /home/stack/network_data.yaml \
-r /home/stack/roles_data.yaml \
```

3.3.2. Configuring a custom IPv6 provisioning network

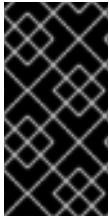

IMPORTANT

This feature is available in this release as a *Technology Preview*, and therefore is not fully supported by Red Hat. It should only be used for testing, and should not be deployed in a production environment. For more information about Technology Preview features, see [Scope of Coverage Details](#).

Create a custom IPv6 provisioning network to provision and deploy the overcloud over IPv6.

Procedure

1. Configure the shell to access Identity as the administrative user:

```
$ source ~/stackrc
```

2. Copy the **network_data.yaml** file:

```
$ cp /usr/share/openstack-tripleo-heat-templates/network_data.yaml .
```

3. Edit the new **network_data.yaml** file and add a new network for overcloud provisioning:

```
# custom network for IPv6 overcloud provisioning
- name: OcProvisioningIPv6
  vip: true
  name_lower: oc_provisioning_ipv6
  vlan: 10
  ipv6: true
  ipv6_subnet: '$IPV6_SUBNET_ADDRESS/$IPV6_MASK'
  ipv6_allocation_pools: [{'start': '$IPV6_START_ADDRESS', 'end': '$IPV6_END_ADDRESS'}]
  gateway_ipv6: '$IPV6_GW_ADDRESS'
```

- Replace **\$IPV6_ADDRESS** with the IPv6 address of your IPv6 subnet.
 - Replace **\$IPV6_MASK** with the IPv6 network mask for your IPv6 subnet.
 - Replace **\$IPV6_START_ADDRESS** and **\$IPV6_END_ADDRESS** with the IPv6 range that you want to use for address allocation.
 - Replace **\$IPV6_GW_ADDRESS** with the IPv6 address of your gateway.
4. Create a new file **network-environment.yaml** and define IPv6 settings for the provisioning network:

```
$ touch /home/stack/network-environment.yaml`
```

- a. Remap the ironic networks to use the new IPv6 provisioning network:

```
ServiceNetMap:
  IronicApiNetwork: oc_provisioning_ipv6
  IronicNetwork: oc_provisioning_ipv6
```

- b. Set the **IronicIpVersion** parameter to **6**:

```
parameter_defaults:
  IronicIpVersion: 6
```

- c. Set the **RabbitIPv6**, **MysqlIPv6**, and **RedisIPv6** parameters to **True**:

```
parameter_defaults:
  RabbitIPv6: True
  MysqlIPv6: True
  RedisIPv6: True
```

- d. Set the **ControlPlaneSubnetCidr** parameter to the subnet IPv6 mask length for the provisioning network:

```
parameter_defaults:
  ControlPlaneSubnetCidr: '64'
```

- e. Set the **ControlPlaneDefaultRoute** parameter to the IPv6 address of the gateway router for the provisioning network:

```
parameter_defaults:
  ControlPlaneDefaultRoute: <ipv6-address>
```

5. Add an interface and necessary parameters to the **nic-configs/controller.yaml** file:

```
$network_config:
  - type: vlan
    vlan_id:
      get_param: OcProvisioningIPv6NetworkVlanID
    addresses:
      - ip_netmask:
          get_param: OcProvisioningIPv6IpSubnet
```

6. Copy the **roles_data.yaml** file:

```
(undercloud) [stack@host01 ~]$ cp /usr/share/openstack-tripleo-heat-templates/roles_data.yaml .
```

7. Edit the new **roles_data.yaml** and add the new network for the controller:

```
networks:
  ...
  - OcProvisioningIPv6
```

When you deploy the overcloud, include the new **network_data.yaml** and **roles_data.yaml** files in the deployment command with the **-n** and **-r** options, and the **network-environment.yaml** file with the **-e** option:

```
$ sudo openstack overcloud deploy --templates \
...
-n /home/stack/network_data.yaml \
-r /home/stack/roles_data.yaml \
-e /home/stack/network-environment.yaml
...
```

For more information about IPv6 network configuration, see [Configuring the network](#) in the *IPv6 Networking for the Overcloud* guide.

3.4. EXAMPLE TEMPLATES

The following is an example template file. This file might not meet the requirements of your environment. Before using this example, ensure that it does not interfere with any existing configuration in your environment.

~/templates/ironic.yaml

```
parameter_defaults:
  NovaSchedulerDefaultFilters:
    - RetryFilter
    - AggregateInstanceExtraSpecsFilter
    - AvailabilityZoneFilter
    - ComputeFilter
    - ComputeCapabilitiesFilter
    - ImagePropertiesFilter

  IronicCleaningDiskErase: metadata
```

In this example:

- The **AggregateInstanceExtraSpecsFilter** allows both virtual and bare metal instances, for a hybrid deployment.
- Disk cleaning that is done before and between deployments erases only the partition table (metadata).

3.5. ENABLING IRONIC INTROSPECTION IN THE OVERCLOUD

To enable Bare Metal introspection, include both the following files in the deploy command:

For deployments using OVN

- `ironic-overcloud.yaml`
- `ironic-inspector.yaml`

For deployments using OVS

- `ironic.yaml`
- `ironic-inspector.yaml`

You can find these files in the `/usr/share/openstack-tripleo-heat-templates/environments/services` directory. Use the following example to include configuration details for the ironic inspector that correspond to your environment:

```
parameter_defaults:
  IronicInspectorSubnets:
```

```
- ip_range: 192.168.101.201,192.168.101.250
IPImageURLs: ["http://192.168.24.1:8088/agent.kernel",
"http://192.168.24.1:8088/agent.ramdisk"]
IronicInspectorInterface: 'br-baremetal'
```

IronicInspectorSubnets

This parameter can contain multiple ranges and works with both spine and leaf.

IPImageURLs

This parameter contains details about the IPA kernel and ramdisk. In most cases, you can use the same images that you use on the undercloud. If you omit this parameter, place alternatives on each controller.

IronicInspectorInterface

Use this parameter to specify the bare metal network interface.



NOTE

If you use a composable Ironic or IronicConductor role, you must include the **IronicInspector** service in the Ironic role in your roles file.

```
ServicesDefault:
  OS::TripleO::Services::IronicInspector
```

3.6. DEPLOYING THE OVERCLOUD

To enable the Bare Metal service, include your ironic environment files with the **-e** option when deploying or redeploying the overcloud, along with the rest of your overcloud configuration.

For example:

```
$ openstack overcloud deploy \
--templates \
-e ~/templates/node-info.yaml \
-e /usr/share/openstack-tripleo-heat-templates/environments/network-isolation.yaml \
-e ~/templates/network-environment.yaml \
-e /usr/share/openstack-tripleo-heat-templates/environments/services/ironic-overcloud.yaml \
-e ~/templates/ironic.yaml \
```

For more information about deploying the overcloud, see [Deployment command options](#) and [Including Environment Files in Overcloud Creation](#) in the *Director Installation and Usage* guide.

For more information about deploying the overcloud over IPv6, see [Setting up your environment](#) and [Creating the overcloud](#) in the *IPv6 Networking for the Overcloud* guide.

3.7. TESTING THE BARE METAL SERVICE

You can use the OpenStack Integration Test Suite to validate your Red Hat OpenStack deployment. For more information, see the [OpenStack Integration Test Suite Guide](#).

Additional Ways to Verify the Bare Metal Service:

1. Configure the shell to access Identity as the administrative user:

```
$ source ~/overcloudrc
```

2. Check that the **nova-compute** service is running on the controller nodes:

```
$ openstack compute service list -c Binary -c Host -c Status
```

3. If you have changed the default ironic drivers, ensure that the required drivers are enabled:

```
$ openstack baremetal driver list
```

4. Ensure that the ironic endpoints are listed:

```
$ openstack catalog list
```

CHAPTER 4. CONFIGURING FOR THE BARE METAL SERVICE AFTER DEPLOYMENT

This section describes the steps necessary to configure your overcloud after deployment.

4.1. CONFIGURING OPENSTACK NETWORKING

Configure OpenStack Networking to communicate with the Bare Metal service for DHCP, PXE boot, and other requirements. You can configure the bare metal network in two ways:

- Use a flat bare metal network for Ironic Conductor services. This network must route to the Ironic services on the control plane network.
- Use a custom composable network to implement Ironic services in the overcloud.

Follow the procedures in this section to configure OpenStack Networking for a single flat network for provisioning onto bare metal, or to configure a new composable network that does not rely on an unused isolated network or a flat network. The configuration uses the ML2 plug-in and the Open vSwitch agent.

Perform all steps in the following procedure on the server that hosts the OpenStack Networking service, while logged in as the **root** user.

4.1.1. Configuring OpenStack Networking to Communicate with the Bare Metal Service on a flat Bare Metal Network

1. Configure the shell to access Identity as the administrative user:

```
$ source ~/overcloudrc
```

2. Create the flat network over which to provision bare metal instances:

```
$ openstack network create \
  --provider-network-type flat \
  --provider-physical-network baremetal \
  --share NETWORK_NAME
```

Replace *NETWORK_NAME* with a name for this network. The name of the physical network over which the virtual network is implemented (in this case **baremetal**) was set earlier in the `~/templates/network-environment.yaml` file, with the parameter **NeutronBridgeMappings**.

3. Create the subnet on the flat network:

```
$ openstack subnet create \
  --network NETWORK_NAME \
  --subnet-range NETWORK_CIDR \
  --ip-version 4 \
  --gateway GATEWAY_IP \
  --allocation-pool start=START_IP,end=END_IP \
  --dhcp SUBNET_NAME
```

Replace the following values:

- Replace *SUBNET_NAME* with a name for the subnet.

- Replace *NETWORK_NAME* with the name of the provisioning network that you created in the previous step.
 - Replace *NETWORK_CIDR* with the Classless Inter-Domain Routing (CIDR) representation of the block of IP addresses that the subnet represents. The block of IP addresses specified by the range starting with *START_IP* and ending with *END_IP* must fall within the block of IP addresses specified by *NETWORK_CIDR*.
 - Replace *GATEWAY_IP* with the IP address or host name of the router interface that acts as the gateway for the new subnet. This address must be within the block of IP addresses specified by *NETWORK_CIDR*, but outside of the block of IP addresses specified by the range starting with *START_IP* and ending with *END_IP*.
 - Replace *START_IP* with the IP address that denotes the start of the range of IP addresses within the new subnet from which floating IP addresses will be allocated.
 - Replace *END_IP* with the IP address that denotes the end of the range of IP addresses within the new subnet from which floating IP addresses will be allocated.
4. Create a router for the network and subnet to ensure that the OpenStack Networking Service serves metadata requests:

```
$ openstack router create ROUTER_NAME
```

Replace **ROUTER_NAME** with a name for the router.

5. Attach the subnet to the new router:

```
$ openstack router add subnet ROUTER_NAME BAREMETAL_SUBNET
```

Replace *ROUTER_NAME* with the name of your router and *BAREMETAL_SUBNET* with the ID or name of the subnet that you created previously. This allows the metadata requests from **cloud-init** to be served and the node configured.

4.1.2. Configuring OpenStack Networking to Communicate with the Bare Metal Service on a Custom Composable Bare Metal Network

1. Create a vlan network with a VlanID that matches the **OcProvisioning** network that you create during deployment. Name the new network **provisioning** to match the default name of the cleaning network.

```
(overcloud) [stack@host01 ~]$ openstack network create \
  --share \
  --provider-network-type vlan \
  --provider-physical-network datacentre \
  --provider-segment 205 provisioning
```

If the name of the overcloud network is not **provisioning**, log in to the controller and run the following commands to rename and restart the network:

```
heat-admin@overcloud-controller-0 ~]$ sudo vi /var/lib/config-data/puppet-generated/ironic/etc/ironic/ironic.conf
```

```
heat-admin@overcloud-controller-0 ~]$ sudo podman restart ironic_conductor
```

4.2. CONFIGURING NODE CLEANING

By default, the Bare Metal service is set to use a network named **provisioning** for node cleaning. However, network names are not unique in OpenStack Networking, so it is possible for a tenant to create a network with the same name, causing a conflict with the Bare Metal service. Therefore, it is recommended to use the network UUID instead.

1. Configure cleaning by providing the provider network UUID on the controller running the Bare Metal Service:

```
~/templates/ironic.yaml
```

```
parameter_defaults:
  IronicCleaningNetwork: UUID
```

Replace *UUID* with the UUID of the bare metal network that you create in the previous steps.

You can find the UUID with the **openstack network show** command:

```
openstack network show NETWORK_NAME -f value -c id
```

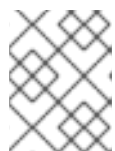

NOTE

You must perform this configuration after the initial overcloud deployment, because the UUID for the network is not available beforehand.

2. Apply the changes by redeploying the overcloud with the **openstack overcloud deploy** command as described in [Section 3.6, "Deploying the Overcloud"](#).
3. Uncomment the following line and replace **<None>** with the UUID of the bare metal network:

```
cleaning_network = <None>
```

4. Restart the Bare Metal service:

```
# systemctl restart openstack-ironic-conductor.service
```

Redeploying the overcloud with **openstack overcloud deploy** reverts any manual changes, so ensure that you have added the cleaning configuration to `~/templates/ironic.yaml` (described in the previous step) before you next use the **openstack overcloud deploy** command.

4.2.1. Manual Node Cleaning

To initiate node cleaning manually, the node must be in the **manageable** state.

Node cleaning has two modes:

Metadata only clean - Removes partitions from all disks on a given node. This is a faster clean cycle, but less secure since it erases only partition tables. Use this mode only on trusted tenant environments.

Full clean - Removes all data from all disks, using either ATA secure erase or by shredding. This can take several hours to complete.

To initiate a **metadata** clean:

```
$ openstack baremetal node clean _UUID_ \
  --clean-steps '[{"interface": "deploy", "step": "erase_devices_metadata"}]'
```

To initiate a **full** clean:

```
$ openstack baremetal node clean _UUID_ \
  --clean-steps '[{"interface": "deploy", "step": "erase_devices"}]'
```

Replace *UUID* with the UUID of the node that you want to clean.

After a successful cleaning, the node state returns to **manageable**. If the state is **clean failed**, inspect the **last_error** field for the cause of failure.

4.3. CREATING THE BARE METAL FLAVOR

You must create a flavor to use as a part of the deployment. The specifications (memory, CPU, and disk) of this flavor must be equal to or less than the hardware specifications of your bare metal node.

1. Configure the shell to access Identity as the administrative user:

```
$ source ~/overcloudrc
```

2. List existing flavors:

```
$ openstack flavor list
```

3. Create a new flavor for the Bare Metal service:

```
$ openstack flavor create \
  --id auto --ram RAM \
  --vcpus VCPU --disk DISK \
  --property baremetal=true \
  --public baremetal
```

Replace **RAM** with the amount of memory, **VCPU** with the number of vCPUs and **DISK** with the disk storage value. The property **baremetal** is used to distinguish bare metal from virtual instances.

4. Verify that the new flavor is created with the correct values:

```
$ openstack flavor list
```

4.4. CREATING THE BARE METAL IMAGES

The deployment requires two sets of images:

- The **deploy image** is used by the Bare Metal service to boot the bare metal node and copy a user image onto the bare metal node. The deploy image consists of the **kernel** image and the **ramdisk** image.
- The **user image** is the image deployed onto the bare metal node. The user image also has a **kernel** image and **ramdisk** image, but additionally, the user image contains a **main** image. The main image is either a root partition, or a whole-disk image.

- A **whole-disk image** is an image that contains the partition table and boot loader. The Bare Metal service does not control the subsequent reboot of a node deployed with a whole-disk image as the node supports localboot.
- A **root partition image** contains only the root partition of the operating system. If you use a root partition, after the deploy image is loaded into the Image service, you can set the deploy image as the node boot image in the node properties. A subsequent reboot of the node uses netboot to pull down the user image.

The examples in this section use a root partition image to provision bare metal nodes.

4.4.1. Preparing the Deploy Images

You do not have to create the deploy image as it was already used when the overcloud was deployed by the undercloud. The deploy image consists of two images - the kernel image and the ramdisk image:

```
/tftpboot/agent.kernel
/tftpboot/agent.ramdisk
```

These images are often in the home directory, unless you have deleted them, or unpacked them elsewhere. If they are not in the home directory, and you still have the **rhosp-director-images-ipa** package installed, these images are in the **/usr/share/rhosp-director-images/ironic-python-agent*.tar** file.

Extract the images and upload them to the Image service:

```
$ openstack image create \
  --container-format aki \
  --disk-format aki \
  --public \
  --file ./tftpboot/agent.kernel bm-deploy-kernel
$ openstack image create \
  --container-format ari \
  --disk-format ari \
  --public \
  --file ./tftpboot/agent.ramdisk bm-deploy-ramdisk
```

4.4.2. Preparing the User Image

The final image that you need is the user image that will be deployed on the bare metal node. User images also have a kernel and ramdisk, along with a main image. To download and install these packages, you must first configure whole disk image environment variables to suit your requirements.

4.4.3. Disk image environment variables

As a part of the disk image building process, the director requires a base image and registration details to obtain packages for the new overcloud image. Define these attributes with the following Linux environment variables.

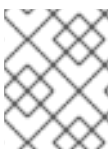

NOTE

The image building process temporarily registers the image with a Red Hat subscription and unregisters the system when the image building process completes.

To build a disk image, set Linux environment variables that suit your environment and requirements:

DIB_LOCAL_IMAGE

Sets the local image that you want to use as the basis for your whole disk image.

REG_ACTIVATION_KEY

Use an activation key instead of login details as part of the registration process.

REG_AUTO_ATTACH

Defines whether to attach the most compatible subscription automatically.

REG_BASE_URL

The base URL of the content delivery server that contains packages for the image. The default Customer Portal Subscription Management process uses **https://cdn.redhat.com**. If you use a Red Hat Satellite 6 server, set this parameter to the base URL of your Satellite server.

REG_ENVIRONMENT

Registers to an environment within an organization.

REG_METHOD

Sets the method of registration. Use **portal** to register a system to the Red Hat Customer Portal. Use **satellite** to register a system with Red Hat Satellite 6.

REG_ORG

The organization where you want to register the images.

REG_POOL_ID

The pool ID of the product subscription information.

REG_PASSWORD

Sets the password for the user account that registers the image.

REG_REPOS

A comma-separated string of repository names. Each repository in this string is enabled through **subscription-manager**.

REG_SAT_URL

The base URL of the Satellite server to register overcloud nodes. Use the Satellite HTTP URL and not the HTTPS URL for this parameter. For example, use <http://satellite.example.com> and not <https://satellite.example.com>.

REG_SERVER_URL

Sets the host name of the subscription service to use. The default host name is for the Red Hat Customer Portal at **subscription.rhn.redhat.com**. If you use a Red Hat Satellite 6 server, set this parameter to the host name of your Satellite server.

REG_USER

Sets the user name for the account that registers the image.

4.4.4. Installing the User Image

1. Download the Red Hat Enterprise Linux KVM guest image from the [Customer Portal](#) (requires login).
2. Define `DIB_LOCAL_IMAGE` as the downloaded image:

```
$ export DIB_LOCAL_IMAGE=rhel-8.0-x86_64-kvm.qcow2
```

3. Set your registration information. If you use Red Hat Customer Portal, you must configure the following information:

```
$ export REG_USER='USER_NAME'
$ export REG_PASSWORD='PASSWORD'
$ export REG_AUTO_ATTACH=true
$ export REG_METHOD=portal
$ export https_proxy='IP_address:port' (if applicable)
$ export http_proxy='IP_address:port' (if applicable)
```

If you use Red Hat Satellite, you must configure the following information:

```
$ export REG_USER='USER_NAME'
$ export REG_PASSWORD='PASSWORD'
$ export REG_SAT_URL='<SATELLITE URL>'
$ export REG_ORG='<SATELLITE ORG>'
$ export REG_ENV='<SATELLITE ENV>'
$ export REG_METHOD='<METHOD>'
```

If you have any offline repositories, you can define `DIB_YUM_REPO_CONF` as local repository configuration:

```
$ export DIB_YUM_REPO_CONF='<path-to-local-repository-config-file>'
```

4. Create the user images using the **diskimage-builder** tool:

```
$ disk-image-create rhel8 baremetal -o rhel-image
```

This command extracts the kernel as **rhel-image.vmlinuz** and initial ramdisk as **rhel-image.initrd**.

5. Upload the images to the Image service:

```
$ KERNEL_ID=$(openstack image create \
  --file rhel-image.vmlinuz --public \
  --container-format aki --disk-format aki \
  -f value -c id rhel-image.vmlinuz)
$ RAMDISK_ID=$(openstack image create \
  --file rhel-image.initrd --public \
  --container-format ari --disk-format ari \
  -f value -c id rhel-image.initrd)
$ openstack image create \
  --file rhel-image.qcow2 --public \
  --container-format bare \
  --disk-format qcow2 \
  --property kernel_id=$KERNEL_ID \
  --property ramdisk_id=$RAMDISK_ID \
  rhel-image
```

4.5. CONFIGURING DEPLOY INTERFACES

When provisioning bare metal nodes, the Ironic service on the overcloud writes a base operating system image to the disk on the bare metal node. By default, the deploy interface mounts the image on an iSCSI mount and then copies the image to disk on each node. Alternatively, you can use **direct deploy**, which

writes disk images from a HTTP location directly to disk on bare metal nodes.

4.5.1. Understanding the deploy process

Deploy interfaces have a critical role in the provisioning process. Deploy interfaces orchestrate the deployment and define the mechanism for transferring the image to the target disk.

Prerequisites

- Dependent packages configured on the bare metal service nodes that run **ironic-conductor**.
- OpenStack Compute (nova) must be configured to use the bare metal service endpoint.
- Flavors must be created for the available hardware, and nova must boot the new node from the correct flavor.
- Images must be available in Glance:
 - bm-deploy-kernel
 - bm-deploy-ramdisk
 - user-image
 - user-image-vmlinuz
 - user-image-initrd
- Hardware to enroll with the Ironic API service.

Workflow

Use the following example workflow to understand the standard deploy process. Depending on the ironic driver interfaces that you use, some of the steps might differ:

1. The Nova scheduler receives a boot instance request from the Nova API.
2. The Nova scheduler identifies the relevant hypervisor and identifies the target physical node.
3. The Nova compute manager claims the resources of the selected hypervisor.
4. The Nova compute manager creates unbound tenant virtual interfaces (VIFs) in the Networking service according to the network interfaces that the nova boot request specifies.
5. Nova compute invokes **driver.spawn** from the Nova compute virt layer to create a spawn task that contains all of the necessary information. During the spawn process, the virt driver completes the following steps.
 - a. Updates the target ironic node with information about the deploy image, instance UUID, requested capabilities, and flavor properties.
 - b. Calls the ironic API to validate the power and deploy interfaces of the target node.
 - c. Attaches the VIFs to the node. Each neutron port can be attached to any ironic port or group. Port groups have higher priority than ports.
 - d. Generates config drive.

6. The Nova ironic virt driver issues a deploy request with the Ironic API to the Ironic conductor that services the bare metal node.
7. Virtual interfaces are plugged in and the Neutron API updates DHCP to configure PXE/TFTP options.
8. The ironic node boot interface prepares (i)PXE configuration and caches the deploy kernel and ramdisk.
9. The ironic node management interface issues commands to enable network boot of the node.
10. The ironic node deploy interface caches the instance image, kernel, and ramdisk, if necessary.
11. The ironic node power interface instructs the node to power on.
12. The node boots the deploy ramdisk.
13. With iSCSI deployment, the conductor copies the image over iSCSI to the physical node. With direct deployment, the deploy ramdisk downloads the image from a temporary URL. This URL must be a Swift API compatible object store or a HTTP URL.
14. The node boot interface switches PXE configuration to refer to instance images and instructs the ramdisk agent to soft power off the node. If the soft power off fails, the bare metal node is powered off with IPMI/BMC.
15. The deploy interface instructs the network interface to remove any provisioning ports, binds the tenant ports to the node, and powers the node on.

The provisioning state of the new bare metal node is now **active**.

4.5.2. Configuring the direct deploy interface on the overcloud

The iSCSI deploy interface is the default deploy interface. However, you can enable the direct deploy interface to download an image from a HTTP location to the target disk.



NOTE

Your overcloud node memory **tmpfs** must have at least 8GB of RAM.

Procedure

1. Create or modify a custom environment file `/home/stack/templates/direct_deploy.yaml` and specify the **IronicEnabledDeployInterfaces** and the **IronicDefaultDeployInterface** parameters.

```
parameter_defaults:
  IronicEnabledDeployInterfaces: direct
  IronicDefaultDeployInterface: direct
```

If you register your nodes with `iscsi`, retain the **iscsi** value in the **IronicEnabledDeployInterfaces** parameter:

```
parameter_defaults:
  IronicEnabledDeployInterfaces: direct,iscsi
  IronicDefaultDeployInterface: direct
```

- By default, the Bare Metal Service (ironic) agent on each node obtains the image stored in the Object Storage Service (swift) through a HTTP link. Alternatively, Ironic can stream this image directly to the node through the **ironic-conductor** HTTP server. To change the service providing the image, set the **IronicImageDownloadSource** to **http** in the **/home/stack/templates/direct_deploy.yaml** file:

```
parameter_defaults:
  IronicEnabledDeployInterfaces: direct
  IronicDefaultDeployInterface: direct
  IronicImageDownloadSource: http
```

- Include the custom environment with your overcloud deployment:

```
$ openstack overcloud deploy \
  --templates \
  ...
  -e /usr/share/openstack-tripleo-heat-templates/environments/services/ironic.yaml \
  -e /home/stack/templates/direct_deploy.yaml \
  ...
```

Wait until deployment completes.

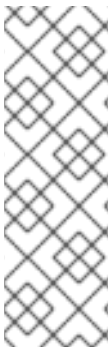

NOTE

If you did not specify **IronicDefaultDeployInterface** or to use a different deploy interface, specify the deploy interface when you create or update a node:

+

```
$ openstack baremetal node create --driver ipmi --deploy-interface direct
$ openstack baremetal node set <NODE> --deploy-interface direct
```

4.6. ADDING PHYSICAL MACHINES AS BARE METAL NODES

There are two methods to enroll a bare metal node:

- Prepare an inventory file with the node details, import the file into the Bare Metal service, and make the nodes available.
- Register a physical machine as a bare metal node, then manually add its hardware details and create ports for each of its Ethernet MAC addresses. These steps can be performed on any node which has your overcloudrc file.

Both methods are detailed in this section.

After enrolling the physical machines, Compute is not immediately notified of new resources, because Compute's resource tracker synchronizes periodically. Changes will be visible after the next periodic task is run. This value, **scheduler_driver_task_period**, can be updated in **/etc/nova/nova.conf**. The default period is 60 seconds.

4.6.1. Enrolling a Bare Metal Node With an Inventory File

- Create a file **overcloud-nodes.yaml**, including the node details. You can enroll multiple nodes with one file.

```

nodes:
  - name: node0
    driver: ipmi
    driver_info:
      ipmi_address: <IPMI_IP>
      ipmi_username: <USER>
      ipmi_password: <PASSWORD>
    properties:
      cpus: <CPU_COUNT>
      cpu_arch: <CPU_ARCHITECTURE>
      memory_mb: <MEMORY>
      local_gb: <ROOT_DISK>
      root_device:
        serial: <SERIAL>
    ports:
      - address: <PXE_NIC_MAC>

```

Replace the following values:

- **<IPMI_IP>** with the address of the Bare Metal controller.
- **<USER>** with your username.
- **<PASSWORD>** with your password.
- **<CPU_COUNT>** with the number of CPUs.
- **<CPU_ARCHITECTURE>** with the type of architecture of the CPUs.
- **<MEMORY>** with the amount of memory in MiB.
- **<ROOT_DISK>** with the size of the root disk in GiB.
- **<MAC_ADDRESS>** with the MAC address of the NIC used to PXE boot.
You must include **root_device** only if the machine has multiple disks. Replace **<SERIAL>** with the serial number of the disk that you want to use for deployment.

2. Configure the shell to use Identity as the administrative user:

```
$ source ~/overcloudrc
```

3. Import the inventory file into ironic:

```
$ openstack baremetal create overcloud-nodes.yaml
```

4. The nodes are now in the **enroll** state.

5. Specify the deploy kernel and deploy ramdisk on each node:

```
$ openstack baremetal node set NODE_UUID \
  --driver-info deploy_kernel=KERNEL_UUID \
  --driver-info deploy_ramdisk=INITRAMFS_UUID
```

Replace the following values:

- Replace `NODE_UUID` with the unique identifier for the node. Alternatively, use the node's logical name.
- Replace `KERNEL_UUID` with the unique identifier for the **kernel** deploy image that was uploaded to the Image service. Find this value with the following command:

```
$ openstack image show bm-deploy-kernel -f value -c id
```

- Replace `INITRAMFS_UUID` with the unique identifier for the **ramdisk** image that was uploaded to the Image service. Find this value with the following command:

```
$ openstack image show bm-deploy-ramdisk -f value -c id
```

6. Set the node's provisioning state to **available**:

```
$ openstack baremetal node manage _NODE_UUID_
$ openstack baremetal node provide _NODE_UUID_
```

The bare metal service cleans the node if you enabled node cleaning,

7. Check that the nodes were successfully enrolled:

```
$ openstack baremetal node list
```

There may be a delay between enrolling a node and its state being shown.

4.6.2. Enrolling a Bare Metal Node Manually

1. Configure the shell to use Identity as the administrative user:

```
$ source ~/overcloudrc
```

2. Add a new node:

```
$ openstack baremetal node create --driver ipmi --name NAME
```

To create a node, you must specify the driver name. This example uses **ipmi**. To use a different driver, you must enable the driver by setting the **IronicEnabledDrivers** parameter. For more information on supported drivers, see [Appendix A, Bare Metal Drivers](#).

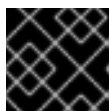

IMPORTANT

Note the unique identifier for the node.

3. Update the node driver information to allow the Bare Metal service to manage the node:

```
$ openstack baremetal node set NODE_UUID \
  --driver_info PROPERTY=VALUE \
  --driver_info PROPERTY=VALUE
```

Replace the following values:

- Replace *NODE_UUID* with the unique identifier for the node. Alternatively, use the node's logical name.
- Replace *PROPERTY* with a required property returned by the **ironic driver-properties** command.
- Replace *VALUE* with a valid value for that property.

4. Specify the deploy kernel and deploy ramdisk for the node driver:

```
$ openstack baremetal node set NODE_UUID \
  --driver-info deploy_kernel=KERNEL_UUID \
  --driver-info deploy_ramdisk=INITRAMFS_UUID
```

Replace the following values:

- Replace *NODE_UUID* with the unique identifier for the node. Alternatively, use the node's logical name.
- Replace *KERNEL_UUID* with the unique identifier for the **.kernel** image that was uploaded to the Image service.
- Replace *INITRAMFS_UUID* with the unique identifier for the **.initramfs** image that was uploaded to the Image service.

5. Update the node's properties to match the hardware specifications on the node:

```
$ openstack baremetal node set NODE_UUID \
  --property cpus=CPU \
  --property memory_mb=RAM_MB \
  --property local_gb=DISK_GB \
  --property cpu_arch=ARCH
```

Replace the following values:

- Replace *NODE_UUID* with the unique identifier for the node. Alternatively, use the node's logical name.
 - Replace *CPU* with the number of CPUs.
 - Replace *RAM_MB* with the RAM (in MB).
 - Replace *DISK_GB* with the disk size (in GB).
 - Replace *ARCH* with the architecture type.
6. OPTIONAL: Configure the node to reboot after initial deployment from a local boot loader installed on the node's disk, instead of using PXE from **ironic-conductor**. You must also set the local boot capability on the flavor used to provision the node. To enable local boot, the image used to deploy the node must contain **grub2**. Configure local boot:

```
$ openstack baremetal node set NODE_UUID \
  --property capabilities="boot_option:local"
```

Replace *NODE_UUID* with the unique identifier for the node. Alternatively, use the node's logical name.

7. Inform the Bare Metal service of the node's network card by creating a port with the MAC address of the NIC on the provisioning network:

```
$ openstack baremetal port create --node NODE_UUID MAC_ADDRESS
```

Replace *NODE_UUID* with the unique identifier for the node. Replace *MAC_ADDRESS* with the MAC address of the NIC used to PXE boot.

8. If you have multiple disks, set the root device hints. This informs the deploy ramdisk which disk it should use for deployment.

```
$ openstack baremetal node set NODE_UUID \
  --property root_device={"PROPERTY": "VALUE"}
```

Replace with the following values:

- Replace *NODE_UUID* with the unique identifier for the node. Alternatively, use the node's logical name.
- Replace *PROPERTY* and *VALUE* with details about the disk that you want to use for deployment, for example **root_device={'size': 128}**

The following properties are supported:

- **model** (String): Device identifier.
- **vendor** (String): Device vendor.
- **serial** (String): Disk serial number.
- **hctl** (String): Host:Channel:Target:Lun for SCSI.
- **size** (Integer): Size of the device in GB.
- **wwn** (String): Unique storage identifier.
- **wwn_with_extension** (String): Unique storage identifier with the vendor extension appended.
- **wwn_vendor_extension** (String): Unique vendor storage identifier.
- **rotational** (Boolean): True for a rotational device (HDD), otherwise false (SSD).
- **name** (String): The name of the device, for example: /dev/sdb1 Use this property only for devices with persistent names.



NOTE

If you specify more than one property, the device must match all of those properties.

9. Validate the configuration of the node:

```
$ openstack baremetal node validate NODE_UUID
+-----+-----+-----+
| Interface | Result | Reason |
```

```

+-----+-----+-----+
| boot   | False | Cannot validate image information for node |
|        |       | a02178db-1550-4244-a2b7-d7035c743a9b   |
|        |       | because one or more parameters are missing |
|        |       | from its instance_info. Missing are:     |
|        |       | ['ramdisk', 'kernel', 'image_source']    |
| console | None  | not supported                             |
| deploy | False | Cannot validate image information for node |
|        |       | a02178db-1550-4244-a2b7-d7035c743a9b   |
|        |       | because one or more parameters are missing |
|        |       | from its instance_info. Missing are:     |
|        |       | ['ramdisk', 'kernel', 'image_source']    |
| inspect | None  | not supported                             |
| management | True |                                           |
| network | True |                                           |
| power   | True |                                           |
| raid    | True |                                           |
| storage | True |                                           |
+-----+-----+-----+

```

Replace `NODE_UUID` with the unique identifier for the node. Alternatively, use the node's logical name. The output of the **openstack baremetal node validate** command should report either **True** or **None** for each interface. Interfaces marked **None** are those that you have not configured, or those that are not supported for your driver.



NOTE

Interfaces may fail validation due to missing 'ramdisk', 'kernel', and 'image_source' parameters. This result is fine, because the Compute service populates those missing parameters at the beginning of the deployment process.

4.7. CONFIGURING REDFISH VIRTUAL MEDIA BOOT



IMPORTANT

This feature is available in this release as a *Technology Preview*, and therefore is not fully supported by Red Hat. It should only be used for testing, and should not be deployed in a production environment. For more information about Technology Preview features, see [Scope of Coverage Details](#).

You can use Redfish virtual media boot to supply a boot image to the Baseboard Management Controller (BMC) of a node so that the BMC can insert the image into one of the virtual drives. The node can then boot from the virtual drive into the operating system that exists in the image.

Redfish hardware types support booting deploy, rescue, and user images over virtual media. The Bare Metal service (ironic) uses kernel and ramdisk images associated with a node to build bootable ISO images for UEFI or BIOS boot modes at the moment of node deployment. The major advantage of virtual media boot is that you can eliminate the TFTP image transfer phase of PXE and use HTTP GET, or other methods, instead.

4.7.1. Deploying a bare metal server with Redfish virtual media boot



IMPORTANT

This feature is available in this release as a *Technology Preview*, and therefore is not fully supported by Red Hat. It should only be used for testing, and should not be deployed in a production environment. For more information about Technology Preview features, see [Scope of Coverage Details](#).

To boot a node with the **redfish** hardware type over virtual media, set the boot interface to **redfish-virtual-media** and, for UEFI nodes, define the EFI System Partition (ESP) image. Then configure an enrolled node to use Redfish virtual media boot.

Prerequisites

- Redfish driver enabled in the **enabled_hardware_types** parameter in the **undercloud.conf** file.
- A bare metal node registered and enrolled.
- IPA and instance images in the Image Service (glance).
- For UEFI nodes, you must also have an EFI system partition image (ESP) available in the Image Service (glance).
- A bare metal flavor.
- A network for cleaning and provisioning.
- Sushy library installed:

```
$ sudo yum install sushy
```

Procedure

1. Set the Bare Metal service (ironic) boot interface to **redfish-virtual-media**:

```
$ openstack baremetal node set --boot-interface redfish-virtual-media $NODE_NAME
```

Replace **\$NODE_NAME** with the name of the node.

2. For UEFI nodes, set the boot mode to **uefi**:

```
$ openstack baremetal node set --property capabilities="boot_mode:uefi" $NODE_NAME
```

Replace **\$NODE_NAME** with the name of the node.



NOTE

For BIOS nodes, do not complete this step.

3. For UEFI nodes, define the EFI System Partition (ESP) image:

```
$ openstack baremetal node set --driver-info bootloader=$ESP $NODE_NAME
```

Replace **\$ESP** with the glance image UUID or URL for the ESP image, and replace **\$NODE_NAME** with the name of the node.

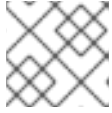
**NOTE**

For BIOS nodes, do not complete this step.

4. Create a port on the bare metal node and associate the port with the MAC address of the NIC on the bare metal node:

```
$ openstack baremetal port create --pxe-enabled True --node $UUID $MAC_ADDRESS
```

Replace **\$UUID** with the UUID of the bare metal node, and replace **\$MAC_ADDRESS** with the MAC address of the NIC on the bare metal node.

5. Create the new bare metal server:

```
$ openstack server create \
  --flavor baremetal \
  --image $IMAGE \
  --network $NETWORK \
  test_instance
```

Replace **\$IMAGE** and **\$NETWORK** with the names of the image and network that you want to use.

4.8. USING HOST AGGREGATES TO SEPARATE PHYSICAL AND VIRTUAL MACHINE PROVISIONING

OpenStack Compute uses host aggregates to partition availability zones, and group together nodes with specific shared properties. When an instance is provisioned, Compute's scheduler compares properties on the flavor with the properties assigned to host aggregates, and ensures that the instance is provisioned in the correct aggregate and on the correct host: either on a physical machine or as a virtual machine.

Complete the steps in this section to perform the following operations:

- Add the property **baremetal** to your flavors, setting it to either **true** or **false**.
- Create separate host aggregates for bare metal hosts and compute nodes with a matching **baremetal** property. Nodes grouped into an aggregate inherit this property.

Creating a Host Aggregate

1. Set the **baremetal** property to **true** on the baremetal flavor.

```
$ openstack flavor set baremetal --property baremetal=true
```

2. Set the **baremetal** property to **false** on the flavors used for virtual instances.

```
$ openstack flavor set FLAVOR_NAME --property baremetal=false
```

3. Create a host aggregate called **baremetal-hosts**:

```
$ openstack aggregate create --property baremetal=true baremetal-hosts
```

4. Add each controller node to the **baremetal-hosts** aggregate:

```
$ openstack aggregate add host baremetal-hosts HOSTNAME
```

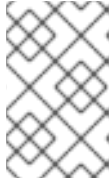
**NOTE**

If you have created a composable role with the **Novalronic** service, add all the nodes with this service to the **baremetal-hosts** aggregate. By default, only the controller nodes have the **Novalronic** service.

5. Create a host aggregate called **virtual-hosts**:

```
$ openstack aggregate create --property baremetal=false virtual-hosts
```

6. Add each compute node to the **virtual-hosts** aggregate:

```
$ openstack aggregate add host virtual-hosts HOSTNAME
```

7. If you did not add the following Compute filter scheduler when deploying the overcloud, add it now to the existing list under **scheduler_default_filters** in */etc/nova/nova.conf*:

```
AggregateInstanceExtraSpecsFilter
```

CHAPTER 5. ADMINISTERING BARE METAL NODES

This chapter describes how to provision a physical machine on an enrolled bare metal node. Instances can be launched either from the command line or from the OpenStack dashboard.

5.1. LAUNCHING AN INSTANCE USING THE COMMAND LINE INTERFACE

Use the **openstack** command line interface to deploy a bare metal instance.

Deploying an Instance on the Command Line

1. Configure the shell to access Identity as the administrative user:

```
$ source ~/overcloudrc
```

2. Deploy the instance:

```
$ openstack server create \  
  --nic net-id=NETWORK_UUID \  
  --flavor baremetal \  
  --image IMAGE_UUID \  
  INSTANCE_NAME
```

Replace the following values:

- Replace *NETWORK_UUID* with the unique identifier for the network that was created for use with the Bare Metal service.
- Replace *IMAGE_UUID* with the unique identifier for the disk image that was uploaded to the Image service.
- Replace *INSTANCE_NAME* with a name for the bare metal instance.

To assign the instance to a security group, include **--security-group SECURITY_GROUP**, replacing *SECURITY_GROUP* with the name of the security group. Repeat this option to add the instance to multiple groups. For more information on security group management, see the [Users and Identity Management Guide](#).

3. Check the status of the instance:

```
$ openstack server list --name INSTANCE_NAME
```

5.2. LAUNCH AN INSTANCE USING THE DASHBOARD

Use the dashboard graphical user interface to deploy a bare metal instance.

Deploying an Instance in the Dashboard

1. Log in to the dashboard at [http\[s\]://DASHBOARD_IP/dashboard](http[s]://DASHBOARD_IP/dashboard).
2. Click **Project > Compute > Instances**

3. Click **Launch Instance**.

- In the **Details** tab, specify the **Instance Name** and select **1** for **Count**.
- In the **Source** tab, select an **Image** from **Select Boot Source**, then click the **+** (plus) symbol to select an operating system disk image. The chosen image moves to **Allocated**.
- In the **Flavor** tab, select **baremetal**.
- In the **Networks** tab, use the **+** (plus) and **-** (minus) buttons to move required networks from **Available** to **Allocated**. Ensure that the shared network created for the Bare Metal service is selected here.
- If you want to assign the instance to a security group, in the **Security Groups** tab, use the arrow to move the group to **Allocated**.

4. Click **Launch Instance**.

5.3. CONFIGURE PORT GROUPS IN THE BARE METAL PROVISIONING SERVICE



NOTE

Port group functionality for bare metal nodes is available in this release as a **Technology Preview**, and therefore is not fully supported by Red Hat. It should be used only for testing, and should not be deployed in a production environment. For more information about Technology Preview features, see [Scope of Coverage Details](#).

Port groups (bonds) provide a method to aggregate multiple network interfaces into a single 'bonded' interface. Port group configuration always takes precedence over an individual port configuration.

If a port group has a physical network, then all the ports in that port group should have the same physical network. The Bare Metal Provisioning service supports configuration of port groups in the instances using **configdrive**.

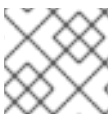

NOTE

Bare Metal Provisioning service API version 1.26 supports port group configuration.

5.3.1. Configure the Switches

To configure port groups in a Bare Metal Provisioning deployment, you must configure the port groups on the switches manually. You must ensure that the mode and properties on the switch correspond to the mode and properties on the bare metal side as the naming can vary on the switch.



NOTE

You cannot use port groups for provisioning and cleaning if you need to boot a deployment using iPXE.

Port group fallback allows all the ports in a port group to fallback to individual switch ports when a connection fails. Based on whether a switch supports port group fallback or not, you can use the `--support-standalone-ports` and --unsupport-standalone-ports` options.`

5.3.2. Configure Port Groups in the Bare Metal Provisioning Service

1. Create a port group by specifying the node to which it belongs, its name, address, mode, properties and whether it supports fallback to standalone ports.

```
# openstack baremetal port group create --node NODE_UUID --name NAME --address
MAC_ADDRESS --mode MODE --property miimon=100 --property
xmit_hash_policy="layer2+3" --support-standalone-ports
```

You can also update a port group using the **openstack baremetal port group set** command.

If you do not specify an address, the deployed instance port group address is the same as the OpenStack Networking port. The port group will not be configured if the **neutron** port is not attached.

During interface attachment, port groups have a higher priority than the ports, so they are used first. Currently, it is **not** possible to specify whether a port group or a port is desired in an interface attachment request. Port groups that do not have any ports will be ignored.



NOTE

Port groups must be configured manually in standalone mode either in the image or by generating the **configdrive** and adding it to the node's **instance_info**. Ensure that you have **cloud-init** version 0.7.7 or later for the port group configuration to work.

2. Associate a port with a port group:

- During port creation:

```
# openstack baremetal port create --node NODE_UUID --address MAC_ADDRESS --
port-group test
```

- During port update:

```
# openstack baremetal port set PORT_UUID --port-group PORT_GROUP_UUID
```

3. Boot an instance by providing an image that has **cloud-init** or supports bonding. To check if the port group has been configured properly, run the following command:

```
# cat /proc/net/bonding/bondX
```

Here, **X** is a number autogenerated by **cloud-init** for each configured port group, starting with a **0** and incremented by one for each configured port group.

5.4. DETERMINING THE HOST TO IP ADDRESS MAPPING

Use the following commands to determine which IP addresses are assigned to which host and also to which bare metal node.

This feature allows you to know the host to IP mapping from the undercloud without needing to access the hosts directly.

```
(undercloud) [stack@host01 ~]$ openstack stack output show overcloud HostsEntry --max-width 80
```

```
+-----+
| Field   | Value                                     |
+-----+
| description | The content that should be appended to your /etc/hosts if you |
|           | want to get                               |
|           | hostname-based access to the deployed nodes (useful for      |
|           | testing without                                               |
|           | setting up a DNS).                                           |
|           |                                                                 |
| output_key | HostsEntry                                                     |
| output_value | 172.17.0.10 overcloud-controller-0.localdomain overcloud-   |
|           | controller-0                                                 |
|           | 10.8.145.18 overcloud-controller-0.external.localdomain     |
|           | overcloud-controller-0.external                             |
|           | 172.17.0.10 overcloud-controller-0.internalapi.localdomain  |
|           | overcloud-controller-0.internalapi                           |
|           | 172.18.0.15 overcloud-controller-0.storage.localdomain      |
|           | overcloud-controller-0.storage                               |
|           | 172.21.2.12 overcloud-controller-0.storagemgmt.localdomain  |
|           | overcloud-controller-0.storagemgmt                           |
|           | 172.16.0.15 overcloud-controller-0.tenant.localdomain       |
|           | overcloud-controller-0.tenant                               |
|           | 10.8.146.13 overcloud-controller-0.management.localdomain   |
|           | overcloud-controller-0.management                           |
|           | 10.8.146.13 overcloud-controller-0.ctlplane.localdomain     |
|           | overcloud-controller-0.ctlplane                             |
|           |                                                                 |
|           | 172.17.0.21 overcloud-compute-0.localdomain overcloud-     |
|           | compute-0                                                   |
|           | 10.8.146.12 overcloud-compute-0.external.localdomain        |
|           | overcloud-compute-0.external                               |
|           | 172.17.0.21 overcloud-compute-0.internalapi.localdomain    |
|           | overcloud-compute-0.internalapi                             |
|           | 172.18.0.20 overcloud-compute-0.storage.localdomain        |
|           | overcloud-compute-0.storage                               |
|           | 10.8.146.12 overcloud-compute-0.storagemgmt.localdomain    |
|           | overcloud-compute-0.storagemgmt                           |
|           | 172.16.0.16 overcloud-compute-0.tenant.localdomain overcloud- |
|           | compute-0.tenant                                           |
|           | 10.8.146.12 overcloud-compute-0.management.localdomain     |
|           | overcloud-compute-0.management                             |
|           | 10.8.146.12 overcloud-compute-0.ctlplane.localdomain       |
|           | overcloud-compute-0.ctlplane                               |
|           |                                                                 |
|           | 10.8.145.16 overcloud.localdomain                           |
|           | 10.8.146.7 overcloud.ctlplane.localdomain                   |
|           | 172.17.0.19 overcloud.internalapi.localdomain              |
|           | 172.18.0.19 overcloud.storage.localdomain                  |
|           | 172.21.2.16 overcloud.storagemgmt.localdomain              |
+-----+
```

To filter a particular host, run the following command:

```
(undercloud) [stack@host01 ~]$ openstack stack output show overcloud HostsEntry -c output_value
-f value | grep overcloud-controller-0
```

```
172.17.0.12 overcloud-controller-0.localdomain overcloud-controller-0
10.8.145.18 overcloud-controller-0.external.localdomain overcloud-controller-0.external
172.17.0.12 overcloud-controller-0.internalapi.localdomain overcloud-controller-0.internalapi
172.18.0.12 overcloud-controller-0.storage.localdomain overcloud-controller-0.storage
172.21.2.13 overcloud-controller-0.storagemgmt.localdomain overcloud-controller-0.storagemgmt
172.16.0.19 overcloud-controller-0.tenant.localdomain overcloud-controller-0.tenant
10.8.146.13 overcloud-controller-0.management.localdomain overcloud-controller-0.management
10.8.146.13 overcloud-controller-0.ctlplane.localdomain overcloud-controller-0.ctlplane
```

To map the hosts to bare metal nodes, run the following command:

```
(undercloud) [stack@host01 ~]$ openstack baremetal node list --fields uuid name instance_info -f
json
[
  {
    "UUID": "c0d2568e-1825-4d34-96ec-f08bbf0ba7ae",
    "Instance Info": {
      "root_gb": "40",
      "display_name": "overcloud-compute-0",
      "image_source": "24a33990-e65a-4235-9620-9243bcff67a2",
      "capabilities": "{\"boot_option\": \"local\"}",
      "memory_mb": "4096",
      "vcpus": "1",
      "local_gb": "557",
      "configdrive": "*****",
      "swap_mb": "0",
      "nova_host_id": "host01.lab.local"
    },
    "Name": "host2"
  },
  {
    "UUID": "8c3faec8-bc05-401c-8956-99c40cdea97d",
    "Instance Info": {
      "root_gb": "40",
      "display_name": "overcloud-controller-0",
      "image_source": "24a33990-e65a-4235-9620-9243bcff67a2",
      "capabilities": "{\"boot_option\": \"local\"}",
      "memory_mb": "4096",
      "vcpus": "1",
      "local_gb": "557",
      "configdrive": "*****",
      "swap_mb": "0",
      "nova_host_id": "host01.lab.local"
    },
    "Name": "host3"
  }
]
```

5.5. ATTACHING AND DETACHING A VIRTUAL NETWORK INTERFACE

The Bare Metal Provisioning service has an API to manage the mapping between virtual network interfaces, for example, the ones used in the OpenStack Networking service and the physical interfaces (NICs). These interfaces are configurable for each Bare Metal Provisioning node, allowing you to set the virtual network interface (VIF) to physical network interface (PIF) mapping logic using the **openstack baremetal node vif*** commands.

The following example procedure describes the steps to attach and detach VIFs.

1. List the VIF IDs currently connected to the bare metal node:

```
$ openstack baremetal node vif list baremetal-0
+-----+
| ID                |
+-----+
| 4475bc5a-6f6e-466d-bcb6-6c2dce0fba16 |
+-----+
```

2. After the VIF is attached, the Bare Metal service updates the virtual port in the OpenStack Networking service with the actual MAC address of the physical port.

This can be checked using the following command:

```
$ openstack port show 4475bc5a-6f6e-466d-bcb6-6c2dce0fba16 -c mac_address -c fixed_ips
+-----+-----+
| Field      | Value                                                                 |
+-----+-----+
| fixed_ips  | ip_address='192.168.24.9', subnet_id='1d11c677-5946-4733-87c3-23a9e06077aa' |
| mac_address | 00:2d:28:2f:8d:95                                                    |
+-----+-----+
```

3. Create a new port on the network where you have created the **baremetal-0** node:

```
$ openstack port create --network baremetal --fixed-ip ip-address=192.168.24.24 baremetal-0-extra
```

4. Remove a port from the instance:

```
$ openstack server remove port overcloud-baremetal-0 4475bc5a-6f6e-466d-bcb6-6c2dce0fba16
```

5. Check that the IP address no longer exists on the list:

```
$ openstack server list
```

6. Check if there are VIFs attached to the node:

```
$ openstack baremetal node vif list baremetal-0
$ openstack port list
```

7. Add the newly created port:

```
$ openstack server add port overcloud-baremetal-0 baremetal-0-extra
```

8. Verify that the new IP address shows the new port:

```
$ openstack server list
+-----+-----+-----+-----+-----+
-----+-----+
| ID              | Name              | Status | Networks          | Image      |
Flavor |
+-----+-----+-----+-----+-----+
-----+-----+
| 53095a64-1646-4dd1-bbf3-b51cbcc38789 | overcloud-controller-2 | ACTIVE | control          | control    |
| 3a1bc89c-5d0d-44c7-a569-f2a3b4c73d65 | overcloud-controller-0 | ACTIVE | control          | control    |
| 6b01531a-f55d-40e9-b3a2-6d02be0b915b | overcloud-controller-1 | ACTIVE | control          | control    |
| c61cc52b-cc48-4903-a971-073c60f53091 | overcloud-novacompute-0overcloud-baremetal-0 | ACTIVE | compute         | compute    |
+-----+-----+-----+-----+-----+
-----+-----+
```

9. Check if the VIF ID is the UUID of the new port:

```
$ openstack baremetal node vif list baremetal-0
+-----+
| ID              |
+-----+
| 6181c089-7e33-4f1c-b8fe-2523ff431ffc |
+-----+
```

10. Check if the OpenStack Networking port MAC address is updated and matches one of the Bare Metal service ports:

```
$ openstack port show 6181c089-7e33-4f1c-b8fe-2523ff431ffc -c mac_address -c fixed_ips
+-----+-----+-----+-----+-----+
| Field      | Value                                     |
+-----+-----+-----+-----+-----+
| fixed_ips | ip_address='192.168.24.24', subnet_id='1d11c677-5946-4733-87c3-23a9e06077aa' |
| mac_address | 00:2d:28:2f:8d:95                       |
+-----+-----+-----+-----+-----+
```

11. Reboot the bare metal node so that it recognizes the new IP address:

```
$ openstack server reboot overcloud-baremetal-0
```

After detaching or attaching interfaces, the bare metal OS removes, adds, or modifies the network interfaces that have changed. When you replace a port, a DHCP request obtains the new IP address, but this may take some time since the old DHCP lease is still valid. The simplest way to initiate these changes immediately is to reboot the bare metal host.

5.6. CONFIGURING NOTIFICATIONS FOR THE BARE METAL SERVICE

You can configure the bare metal service to display notifications for different events that occur within the service. These notifications can be used by external services for billing purposes, monitoring a data store, and so on. This section describes how to enable these notifications.

To enable notifications for the baremetal service, you must set the following options in your **ironic.conf** configuration file.

- The **notification_level** option in the **[DEFAULT]** section determines the minimum priority level for which notifications are sent. The values for this option can be set to **debug**, **info**, **warning**, **error**, or **critical**. If the option is set to **warning**, all notifications with priority level **warning**, **error**, or **critical** are sent, but not notifications with priority level **debug** or **info**. If this option is not set, no notifications are sent. The priority level of each available notification is documented below.
- The **transport_url** option in the **[oslo_messaging_notifications]** section determines the message bus used when sending notifications. If this is not set, the default transport used for RPC is used.

All notifications are emitted on the **ironic_versioned_notifications** topic in the message bus. Generally, each type of message that traverses the message bus is associated with a topic that describes the contents of the message.

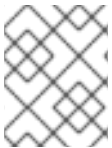

NOTE

The notifications can be lost and there is no guarantee that a notification will make it across the message bus to the end user.

5.7. CONFIGURING AUTOMATIC POWER FAULT RECOVERY

Ironic has a string field **fault** that records power, cleaning, and rescue abort failures for nodes.

Table 5.1. Ironic node faults

Fault	Description
power failure	The node is in maintenance mode due to power sync failures that exceed the maximum number of retries.
clean failure	The node is in maintenance mode due to the failure of a cleaning operation.
rescue abort failure	The node is in maintenance mode due to the failure of a cleaning operation during rescue abort.
none	There is no fault present.

Conductor checks the value of this field periodically. If the conductor detects a **power failure** state and can successfully restore power to the node, the node is removed from maintenance mode and restored to operation.

**NOTE**

If the operator places a node in maintenance mode manually, the conductor does not automatically remove the node from maintenance mode.

The default interval is 300 seconds, however, you can configure this interval with director using hieradata:

```
ironic::conductor::power_failure_recovery_interval
```

To disable automatic power fault recovery, set the value to **0**.

5.8. INTROSPECTING OVERCLOUD NODES

You can perform introspection of Overcloud nodes to monitor the specification of the nodes.

1. Source the rc file:

```
$ source ~/overcloudrc
```

2. Run the introspection command:

```
$ openstack baremetal introspection start [--wait] <NODENAME>
```

Replace <NODENAME> with the name of the node that you want to inspect.

3. Check the introspection status:

```
$ openstack baremetal introspection status <NODENAME>
```

Replace <NODENAME> with the name of the node.

CHAPTER 6. BOOTING FROM CINDER VOLUMES

This section contains information on creating and connecting volumes created in OpenStack Block Storage (cinder) to bare metal instances created with OpenStack Bare Metal (ironic).

6.1. CINDER VOLUME BOOT FOR BARE METAL NODES

You can boot bare metal nodes from a block storage device that is stored in OpenStack Block Storage (cinder). OpenStack Bare Metal (ironic) connects bare metal nodes to volumes through an iSCSI interface.

Ironic enables this feature during the overcloud deployment. However, consider the following conditions prior to deployment:

- The overcloud requires the cinder iSCSI backend to be enabled. Set the **CinderEnableIscsiBackend** heat parameter to **true** during overcloud deployment.
- You cannot use the cinder volume boot feature with a Red Hat Ceph Storage backend.
- You must set the **rd.iscsi.firmware=1** kernel parameter on the boot disk.

6.2. CONFIGURING NODES FOR CINDER VOLUME BOOT

You must configure certain options for each bare metal node to successfully boot from a cinder volume.

Procedure

1. Log in to the undercloud as the **stack** user.
2. Source the overcloud credentials:

```
$ source ~/overcloudrc
```

3. Set the **iscsi_boot** capability to **true** and the **storage-interface** to **cinder** for the selected node:

```
$ openstack baremetal node set --property capabilities=iscsi_boot:true --storage-interface cinder <NODEID>
```

Replace `<NODEID>` with the ID of the chosen node.

4. Create an iSCSI connector for the node:

```
$ openstack baremetal volume connector create --node <NODEID> --type iqn --connector-id iqn.2010-10.org.openstack.node<NUM>
```

The connector ID for each node must be unique. In the example, the connector is **iqn.2010-10.org.openstack.node<NUM>** where **<NUM>** is an incremented number for each node.

6.3. CONFIGURING ISCSI KERNEL PARAMETERS ON THE BOOT DISK

You must enable the iSCSI booting in the kernel on the image. To accomplish this, mount the QCOW2 image and enable iSCSI components on the image.

Prerequisites

1. Download a Red Hat Enterprise Linux QCOW2 image and copy it to the **/home/stack/** directory on the undercloud. You can download Red Hat Enterprise Linux KVM images in QCOW2 format from the following pages:
 - [Red Hat Enterprise Linux 7](#)
 - [Red Hat Enterprise Linux 8](#)

Procedure

1. Log in to the undercloud as the **stack** user.
2. Mount the QCOW2 image and access it as the **root** user:

- a. Load the **nbdk** kernel module:

```
$ sudo modprobe nbdk
```

- b. Connect the QCOW image as **/dev/nbd0**:

```
$ sudo qemu-nbd --connect=/dev/nbd0 <IMAGE>
```

- c. Check the partitions on the NBD:

```
$ sudo fdisk /dev/nbd0 -l
```

New Red Hat Enterprise Linux QCOW2 images contain only one partition, which is usually named **/dev/nbd0p1** on the NBD.

- d. Create a mount point for the image:

```
mkdir /tmp/mountpoint
```

- e. Mount the image:

```
sudo mount /dev/nbd0p1 /tmp/mountpoint/
```

- f. Mount your **dev** directory so that the image has access to device information on the host:

```
sudo mount -o bind /dev /tmp/mountpoint/dev
```

- g. Change the root directory to the mount point:

```
sudo chroot /tmp/mountpoint /bin/bash
```

3. Configure iSCSI on the image:

**NOTE**

Some commands in this step might report the following error:

```
lscpu: cannot open /proc/cpuinfo: No such file or directory
```

This error is not critical and you can ignore the error.

- a. Move the **resolv.conf** file to a temporary location:

```
# mv /etc/resolv.conf /etc/resolv.conf.bak
```

- b. Create a temporary **resolv.conf** file to resolve DNS requests for the Red Hat Content Delivery Network. This example uses **8.8.8.8** for the nameserver:

```
# echo "nameserver 8.8.8.8" > /etc/resolv.conf
```

- c. Register the mounted image to the Red Hat Content Delivery Network:

```
# subscription-manager register
```

Enter your username and password when the command prompts you.

- d. Attach a subscription that contains Red Hat Enterprise Linux:

```
# subscription-manager list --all --available  
# subscription-manager attach --pool <POOLID>
```

Substitute **<POOLID>** with the pool ID of the subscription.

- e. Disable the default repositories:

```
# subscription-manager repos --disable "*"
```

- f. Enable the Red Hat Enterprise Linux repository:

- Red Hat Enterprise Linux 7:

```
# subscription-manager repos --enable "rhel-7-server-rpms"
```

- Red Hat Enterprise Linux 8:

```
# subscription-manager repos --enable "rhel-8-for-x86_64-baseos-eus-rpms"
```

- g. Install the **iscsi-initiator-utils** package:

```
# yum install -y iscsi-initiator-utils
```

- h. Unregister the mounted image:

```
# subscription-manager unregister
```

- i. Restore the original **resolv.conf** file:

```
# mv /etc/resolv.conf.bak /etc/resolv.conf
```

- j. Check the kernel version on the mounted image:

```
# rpm -qa kernel
```

For example, if the output is **kernel-3.10.0-1062.el7.x86_64**, the kernel version is **3.10.0-1062.el7.x86_64**. Note this kernel version for the next step.



NOTE

New Red Hat Enterprise Linux QCOW2 image have only one kernel version installed. If more than one kernel version is installed, use the latest one.

- k. Add the **network** and **iscsi** dracut modules to the initramfs image:

```
# dracut --force --add "network iscsi" /boot/initramfs-<KERNELVERSION>.img  
<KERNELVERSION>
```

Replace **<KERNELVERSION>** with the version you obtained from **rpm -qa kernel**. The following example uses **3.10.0-1062.el7.x86_64** as the kernel version:

```
# dracut --force --add "network iscsi" /boot/initramfs-3.10.0-1062.el7.x86_64.img 3.10.0-1062.el7.x86_64
```

- l. Edit the **/etc/default/grub** configuration file and add **rd.iscsi.firmware=1** to the **GRUB_CMDLINE_LINUX** parameter:

```
# vi /etc/default/grub
```

The following example shows the **GRUB_CMDLINE_LINUX** parameter with the added **rd.iscsi.firmware=1** kernel argument:

```
GRUB_CMDLINE_LINUX="console=tty0 crashkernel=auto console=ttyS0,115200n8  
no_timer_check net.ifnames=0 rd.iscsi.firmware=1"
```

Save these changes.



NOTE

Do not rebuild the **grub** menu configuration at this step. A later step in this procedure rebuilds the **grub** menu as a temporary virtual machine.

- m. Exit from the mounted image back to your host operating system:

```
# exit
```

4. Unmount the image:

- a. Unmount the **dev** directory from the temporary mount point:

```
$ sudo umount /tmp/mountpoint/dev
```

- b. Unmount the image from the mount point:

```
$ sudo umount /tmp/mountpoint
```

- c. Disconnect the QCOW2 image from **/dev/nbd0**:

```
$ sudo qemu-nbd --disconnect /dev/nbd0
```

5. Rebuild the **grub** menu configuration on the image:

- a. Install the **libguestfs-tools** package:

```
$ sudo yum -y install libguestfs-tools
```



IMPORTANT

If you install the **libguestfs-tools** package on the undercloud, disable **iscsid.socket** to avoid port conflicts with the **tripleo_iscsid** service on the undercloud:

```
$ sudo systemctl disable --now iscsid.socket
```

- b. Set the **libguestfs** backend to use QEMU directly:

```
$ export LIBGUESTFS_BACKEND=direct
```

- c. Update the grub configuration on the image:

```
$ guestfish -a <IMAGE> -m /dev/sda1 sh "/sbin/grub2-mkconfig -o /boot/grub2/grub.cfg"
```

6.4. CREATING AND USING A BOOT VOLUME IN CINDER

You must upload the iSCSI-enabled image to OpenStack Image Storage (glance) and create the boot volume in OpenStack Block Storage (cinder).

Procedure

1. Log in to the undercloud as the **stack** user.
2. Upload the iSCSI-enabled image to glance:

```
$ openstack image create --disk-format qcow2 --container-format bare --file rhel-server-7.7-x86_64-kvm.qcow2 rhel-server-7.7-iscsi
```

3. Create a volume from the image:

```
$ openstack volume create --size 10 --image rhel-server-7.7-iscsi --bootable rhel-test-volume
```

4. Create a bare metal instance that uses the boot volume in cinder:

```
█ $ openstack server create --flavor baremetal --volume rhel-test-volume --key default rhel-test
```

CHAPTER 7. ML2 NETWORKING-ANSIBLE

This section contains information on the **networking-ansible** ML2 driver in OpenStack Networking (neutron), integration with OpenStack Bare Metal (ironic), and instructions on enabling and configuring this driver on an overcloud.

7.1. MODULAR LAYER 2 (ML2) NETWORKING-ANSIBLE

OpenStack Networking (neutron) contains **networking-ansible**, which is an ML2 driver that uses Ansible Engine Networking to manage network switches. This driver also integrates with OpenStack Bare Metal (ironic) to configure VLANs on switch ports for the bare metal guests. This means any bare metal guest using a VLAN neutron network causes this driver to configure the physical switch using Ansible Engine Networking.

The current **networking-ansible** driver includes the following functionality:

- Define a VLAN on the switch when creating a network in OpenStack
- Assign a VLAN to an access port on the switch when creating or updating a port in OpenStack
- Remove a VLAN from an access port on the switch when deleting a port in OpenStack

7.2. NETWORKING REQUIREMENTS FOR NETWORKING-ANSIBLE

The following list outlines the networking requirements to enable **networking-ansible** functionality.

- A network switch with Ansible Network Automation support:
 - Juniper Networks (**junos**)
 - Arista Extensible Operating System (**eos**)



IMPORTANT

Arista Extensible Operating System (**eos**) support is available in this release as a *Technology Preview*, and therefore is not fully supported by Red Hat. It should only be used for testing, and should not be deployed in a production environment. For more information about Technology Preview features, see [Scope of Coverage Details](#).

- The network switch also requires an SSH user so that Ansible Network Automation can interact with the device. This user requires certain permissions on the switch:
 - Access mode
 - Assign a VLAN to a port
 - Create VLANs

For security purposes, do not provide the SSH user with administrator access to the switch.

- Prepare the VLANs you intend the switch to use. Preparation involves creating each VLAN on the switch then deleting each VLAN.

- The network switch ports reserved for bare metal guests initially require configuration to connect to the dedicated network for introspection. Beyond this, these ports require no additional configuration.

7.3. OPENSTACK BARE METAL (IRONIC) REQUIREMENTS FOR NETWORKING-ANSIBLE

The **networking-ansible** driver integrates with the Openstack Bare Metal (ironic) service. To ensure successful integration, deploy the ironic service to your overcloud with the following recommendations:

- The overcloud requires a provisioning network. Use one of the following options:
 - A bridged network for Ironic services.
 - A custom composable network for Ironic services.

For more examples of configuring the provisioning network, see [Chapter 3, Deploying an Overcloud with the Bare Metal Service](#).

- The overcloud requires a tenant network for the bare metal systems to use after the provisioning process. The examples in this guide use the default **baremetal** network mapped to a bridge named **br-baremetal**. This network also requires a range of VLAN IDs. The following Heat parameters set these values to suit examples in this guide:

```
parameter_defaults:
  NeutronNetworkVLANRanges: baremetal:1200:1299
  NeutronFlatNetworks: datacentre,baremetal
  NeutronBridgeMappings: datacentre:br-ex,baremetal:br-baremetal
```

- The overcloud uses the introspection service to automatically identify certain hardware details and map them for other services to use. It is recommended that you enable the ironic introspection service to help map your interface-to-port details for **networking-ansible** to use. You can also accomplish this task manually.

For more information on deploying OpenStack Bare Metal (ironic), see [Chapter 3, Deploying an Overcloud with the Bare Metal Service](#).

7.4. ENABLING NETWORKING-ANSIBLE ML2 FUNCTIONALITY

This procedure contains information on how to enable the **networking-ansible** ML2 driver in your overcloud. This involves adding two environment files to your deployment:

/usr/share/openstack-tripleo-heat-templates/environments/neutron-ml2-ansible.yaml

This file enables the **networking-ansible** driver and sets the network type to **vlan**. This file already exists in the core heat template collection.

/home/stack/templates/ml2-ansible-hosts.yaml

A file that contains details about your switches. You create this file manually.

Procedure

1. Create the **/home/stack/templates/ml2-ansible-hosts.yaml** and add the following initial content:

```
parameter_defaults:
  ML2HostConfigs:
```

- The **ML2HostConfigs** parameter requires a **dict** value with details about your switches. Each initial key in the **dict** is a name for the switch. This value defines a specific **ansible: [switchname]** section in your OpenStack Networking (neutron) ML2 configuration. Each switch name key requires its own **dict** containing the actual switch details. For example, to configure three switches, add three switch keys:

```
parameter_defaults:
  ML2HostConfigs:
    switch1:
      [SWITCH DETAILS]
    switch2:
      [SWITCH DETAILS]
    switch3:
      [SWITCH DETAILS]
```

- Each switch requires certain key value pairs in the **dict**:

ansible_network_os

(Required) The operating system of the switch. Options include **junos** and **eos**.



IMPORTANT

Arista Extensible Operating System (**eos**) support is available in this release as a *Technology Preview*, and therefore is not fully supported by Red Hat. It should only be used for testing, and should not be deployed in a production environment. For more information about Technology Preview features, see [Scope of Coverage Details](#).

ansible_host

(Required) The IP or hostname of the switch.

ansible_user

(Required) The user that Ansible uses to access the switch.

ansible_ssh_pass

(Required) The SSH password that Ansible uses to access the switch.

mac

Chassis MAC ID of the network device. Used to map the link layer discovery protocol (LLDP) MAC address value to the switch name defined in the **ML2HostConfigs** configuration. This is a required value when using introspection to perform automatic port configuration.

manage_vlans

A Boolean variable to define whether OpenStack Networking (neutron) controls the creation and deletion of VLANs on the physical device. This functionality causes the switch to create and delete VLANs with IDs respective to their Neutron networks. If you have predefined these VLANs on the switch and do not require Neutron to create or delete VLANs on the switch, set this parameter to **false**. The default value is **true**.

- The following example shows how to map these values to their respective keys in a full **ML2HostConfigs** parameter:

```
parameter_defaults:
  ML2HostConfigs:
    switch1:
      ansible_network_os: juno
      ansible_host: 10.0.0.1
      ansible_user: ansible
      ansible_ssh_pass: "p@55w0rd!"
      mac: 01:23:45:67:89:AB
      manage_vlans: false
```

5. Save the **/home/stack/templates/ml2-ansible-hosts.yaml** file.
6. When running the overcloud deployment command, include the **/usr/share/openstack-tripleo-heat-templates/environments/neutron-ml2-ansible.yaml** and **/home/stack/templates/ml2-ansible-hosts.yaml** files with the **-e** option. The following example demonstrates how to include these files:

```
$ openstack overcloud deploy --templates \
...
-e /usr/share/openstack-tripleo-heat-templates/environments/neutron-ml2-ansible.yaml \
-e /home/stack/templates/ml2-ansible-hosts.yaml \
...
```

The director enables the driver as a part of the OpenStack Networking (neutron) API on the **neutron_api** container.

7.5. CONFIGURING NETWORKS FOR NETWORKING-ANSIBLE

After deploying the overcloud with bare metal provisioning and the **networking-ansible** driver enabled, you must create provisioning and tenant networks for your bare metal nodes. You must also configure ports for your bare metal nodes either in access mode or trunk mode, depending on your requirements.

Access mode

In access mode, switch ports carry the traffic of only one VLAN and operate on a single broadcast domain. All traffic that arrives to access ports belongs to the VLAN that is assigned to the port.

Trunk mode

In trunk mode, switch ports can belong to more than one VLAN. You can use switch ports in trunk mode to carry the traffic of a group of VLANs, or if you want to exchange traffic between multiple switches with more than one VLAN.



IMPORTANT

This feature is available in this release as a *Technology Preview*, and therefore is not fully supported by Red Hat. It should only be used for testing, and should not be deployed in a production environment. For more information about Technology Preview features, see [Scope of Coverage Details](#).

The Bare Metal service (ironic) uses **networking-ansible** to assign the switchport of the bare metal guest to the ironic provisioning network so that the provisioning process can complete successfully. After provisioning is complete, ironic assigns the switchport of the bare metal guest to the VLAN that the Networking service (neutron) assigns to the tenant networks of the bare metal guest.

7.5.1. Configuring networks for networking-ansible in access mode

After deploying the overcloud with bare metal provisioning and the **networking-ansible** driver enabled, create the following networks for your bare metal nodes:

Provisioning network

Bare metal systems use this network for their initial creation.

Tenant network

Bare metal systems switch to this network after provisioning and use this network for internal communication.

Procedure

1. Create the provisioning network and subnet. This depends on the type of provisioning network you are using. See [Chapter 4, Configuring for the Bare Metal Service After Deployment](#) for information on configuring the provisioning network.
2. Create a tenant network and subnet:

```
$ openstack network create --provider-network-type vlan --provider-physical-network
baremetal tenant-net
$ openstack subnet create --network tenant-net --subnet-range 192.168.3.0/24 --allocation-
pool start=192.168.3.10,end=192.168.3.20 tenant-subnet
```

Ensure that you set the **--provider-network-type** option to **vlan** to ensure **networking-ansible** functionality.

7.5.2. Configuring ports for bare metal guests in access mode

Bare metal guests require port information to connect to the switch. There are two methods to accomplish this:

- **Automatic:** Introspection of nodes. The automatic method requires setting the **mac** value for the respective switch as a part of the **ML2HostConfigs** parameter.
- **Manual:** Set the OpenStack Networking (neutron) port configuration. Use this method if your overcloud does not include bare metal introspection functionality.

Procedure

- **Automatic:**

- a. Run the introspection command:

```
$ openstack baremetal introspection start [--wait] <NODENAME>
```

The bare metal nodes obtain the switch's MAC address during introspection. The **networking-ansible** ML2 driver uses this MAC address to map to the same MAC address defined with the **mac** parameter for the respective switch in the **ML2HostConfigs** parameter.

- b. Wait until the introspection completes.

- **Manual:**

1. Create a port for the bare metal node. Use the following example command as a basis to create the port:

```
$ openstack baremetal port create [NODE NIC MAC] --node [NODE UUID] \
  --local-link-connection port_id=[SWICH PORT ID] \
  --local-link-connection switch_info=[SWITCH NAME] \
  --local-link-connection switch_id=[SWITCH MAC]
```

Replace the following values in brackets with your own environment details:

[NODE NIC MAC]

The MAC address of the NIC connected to the switch.

--node [NODE UUID]

The UUID of the node that uses the new port.

--local-link-connection port_id=[SWITCH PORT ID]

The port ID on the switch connecting to the bare metal node.

--local-link-connection switch_info=[SWITCH NAME]

The name of the switch connecting to the bare metal node. The switch name must match the respective switch name you defined in the **ML2HostConfigs** parameter.

--local-link-connection switch_id=[SWITCH MAC]

The MAC address of the switch. This must match the respective **mac** value from the switch configuration from the **ML2HostConfigs** parameter. This is an alternative option to using **switch_info**.

7.5.3. Configuring networks for networking-ansible in trunk mode



IMPORTANT

This feature is available in this release as a *Technology Preview*, and therefore is not fully supported by Red Hat. It should only be used for testing, and should not be deployed in a production environment. For more information about Technology Preview features, see [Scope of Coverage Details](#).

After deploying the overcloud with bare metal provisioning and the **networking-ansible** driver enabled, create the following networks for your bare metal nodes:

Provisioning network

Bare metal systems use this network for their initial creation.

Tenant network

Bare metal systems switch to this network after provisioning and use this network for internal communication.

Procedure

1. Create the provisioning network and subnet. This depends on the type of provisioning network you are using. See [Chapter 4, Configuring for the Bare Metal Service After Deployment](#) for information on configuring the provisioning network.
2. Create a primary tenant VLAN network, a secondary tenant network, and subnets for each network that use the physical network that the guest is attached to:

```
$ openstack network create --provider-network-type vlan --provider-physical-network
baremetal primary-tenant-net
$ openstack network create --provider-network-type vlan --provider-physical-network
baremetal secondary-tenant-net
$ openstack subnet create --network primary-tenant-net --subnet-range 192.168.3.0/24 --
allocation-pool start=192.168.3.10,end=192.168.3.20 primary-tenant-subnet
$ openstack subnet create --network secondary-tenant-net --subnet-range 192.168.7.0/24 --
allocation-pool start=192.168.7.10,end=192.168.7.20 secondary-tenant-subnet
```

Ensure that you set the **--provider-network-type** option to **vlan** to ensure **networking-ansible** functionality.

7.5.4. Configuring ports for bare metal guests in trunk mode



IMPORTANT

This feature is available in this release as a *Technology Preview*, and therefore is not fully supported by Red Hat. It should only be used for testing, and should not be deployed in a production environment. For more information about Technology Preview features, see [Scope of Coverage Details](#).

Bare metal guests require port information to connect to the switch so that you can use the Bare Metal service (ironic) to deploy on multiple networks with a single switch port. The switch port is configured in trunk mode using the VLANs that the Networking service (neutron) assigns from the supplied networks.

Complete the following steps to configure trunk ports for bare metal guests.

Procedure

1. Create a port and a trunk, assigning the port to the trunk as the parent port:

```
$ port create --network primary-tenant-net primary-port
$ network trunk create --parent-port primary-port my-trunk
```

2. Create a port for the secondary network and add the new port as a subport to the trunk:

```
$ port create --network secondary-tenant-net secondary-port
$ network trunk set --subport port=secondary-port,segmentation-type=vlan,segmentation-
id=1234 my-trunk
```

7.6. TESTING NETWORKING-ANSIBLE ML2 FUNCTIONS

After the **networking-ansible** configuration for the bare metal node is complete, test the functionality to ensure it works. This involves creating a bare metal workload.

Prerequisites

- An overcloud with OpenStack Baremetal (ironic) services.
- An enabled **networking-ansible** ML2 driver.
- The **ML2HostConfigs** parameter contains switch access details.

- A registered bare metal node.
- Configuration of the respective bare metal port used for the node connection on the switch. This port can be either an access port or a trunk port.
- A VLAN-based provisioning network defined in OpenStack Networking (neutron) for initial provisioning.
- A VLAN-based tenant network defined in OpenStack Networking (neutron) for internal communication.
- Disk images and key pairs available in the overcloud.

Procedure

1. Create the bare metal system:

- To create a bare metal system that uses an access port, run the following command:

```
openstack server create --flavor baremetal --image overcloud-full --key default --network tenant-net test1
```

- To create a bare metal system that uses a trunk port, run the following command:

```
openstack server create --flavor baremetal --image overcloud-full --port {primary-port-uuid} --key default test1
```

The overcloud initially creates the bare metal system on the provisioning network. When the creation completes, the **networking-ansible** driver changes the port configuration on the switch so that the bare metal system uses the tenant network.

CHAPTER 8. TROUBLESHOOTING THE BARE METAL SERVICE

The following sections contain information and steps that may be useful for diagnosing issues in a setup with the Bare Metal service enabled.

8.1. PXE BOOT ERRORS

Permission Denied Errors

If you get a permission denied error on the console of your Bare Metal service node, ensure that you have applied the appropriate SELinux context to the **/httpboot** and **/tftpboot** directories as follows:

```
# semanage fcontext -a -t httpd_sys_content_t "/httpboot(/.*)?"
# restorecon -r -v /httpboot
# semanage fcontext -a -t tftpd_t "/tftpboot(/.*)?"
# restorecon -r -v /tftpboot
```

Boot Process Freezes at /pxelinux.cfg/XX-XX-XX-XX-XX-XX

On the console of your node, if it looks like you are getting an IP address and then the process stops as shown below:

```
overcloud-baremetal-node on QEMU/KVM
File Virtual Machine View Send Key

IPXE (http://ipxe.org) 00:0C:00 CF00 PC12.10 PnP PMM BFF95EC0 BFEF5EC0 CF00

Booting from ROM...
IPXE (PCI 00:03:0) starting execution...ok
IPXE initialising devices...ok

IPXE 1.0.0* (dc795b9f) -- Open Source Network Boot Firmware -- http://ipxe.org
Features: DNS HTTP iSCSI TFTP AoE ELF MBOOT PXE bzImage Menu PXEXT

net0: 52:54:00:fa:19:88 using virtio-net on PCI00:03:0 (open)
[Link:up, TX:0 TXE:0 RX:0 RXE:0]
Configuring (net0 52:54:00:fa:19:88)... ok
net0: 192.168.200.20/255.255.255.0 gw 192.168.200.9
Next server: 192.168.200.2
Filename: http://192.168.200.2:8088/boot.ipxe
http://192.168.200.2:8088/boot.ipxe... ok
Attempting to boot from MAC 52-54-00-fa-19-88
/pxelinux.cfg/52-54-00-fa-19-88... ok
-
```

This indicates that you might be using the wrong PXE boot template in your **ironic.conf** file.

```
$ grep ^pxe_config_template ironic.conf
pxe_config_template=$pybasedir/drivers/modules/ipxe_config.template
```

The default template is **pxe_config.template**, so it is easy to omit the *i* and inadvertently turn this into **ipxe_config.template**.

8.2. LOGIN ERRORS AFTER THE BARE METAL NODE BOOTS

When you try to log in at the login prompt on the console of the node with the **root** password that you set in the configurations steps, but are not able to, it indicates you are not booted in to the deployed image. You are probably stuck in the **deploy-kernel/deploy-ramdisk** image and the system has yet to get the correct image.

To fix this issue, verify the PXE Boot Configuration file in the **/httpboot/pxelinux.cfg/MAC_ADDRESS** on the Compute or Bare Metal service node and ensure that all the IP addresses listed in this file correspond to IP addresses on the Bare Metal network.



NOTE

The only network the Bare Metal service node knows about is the Bare Metal network. If one of the endpoints is not on the network, the endpoint cannot reach the Bare Metal service node as a part of the boot process.

For example, the kernel line in your file is as follows:

```
kernel http://192.168.200.2:8088/5a6cbe3-2c90-4a90-b3c6-85b449b30512/deploy_kernel selinux=0
disk=cciss/c0d0,sda,hda,vda iscsi_target_iqn=iqn.2008-10.org.openstack:5a6cbe3-2c90-4a90-b3c6-
85b449b30512 deployment_id=5a6cbe3-2c90-4a90-b3c6-85b449b30512
deployment_key=VWDYDVVEFCQJNOSTO9R67HKUXUGP77CK
ironic_api_url=http://192.168.200.2:6385 troubleshoot=0 text nofb nomodeset vga=normal
boot_option=netboot ip=${ip}:${next-server}:${gateway}:${netmask} BOOTIF=${mac} ipa-api-
url=http://192.168.200.2:6385 ipa-driver-name=ipmi boot_mode=bios initrd=deploy_ramdisk
coreos.configdrive=0 || goto deploy
```

Value in the above example kernel line	Corresponding information
http://192.168.200.2:8088	Parameter http_url in /etc/ironic/ironic.conf file. This IP address must be on the Bare Metal network.
5a6cbe3-2c90-4a90-b3c6-85b449b30512	UUID of the baremetal node in openstack baremetal node list .
deploy_kernel	This is the deploy kernel image in the Image service that is copied down as /httpboot/<NODE_UUID>/deploy_kernel .

Value in the above example kernel line	Corresponding information
http://192.168.200.2:6385	Parameter api_url in /etc/ironic/ironic.conf file. This IP address must be on the Bare Metal network.
ipmi	The IPMI Driver in use by the Bare Metal service for this node.
deploy_ramdisk	This is the deploy ramdisk image in the Image service that is copied down as /httpboot/<NODE_UUID>/deploy_ramdisk .

If a value does not correspond between the **/httpboot/pxelinux.cfg/MAC_ADDRESS** and the **ironic.conf** file:

1. Update the value in the **ironic.conf** file
2. Restart the Bare Metal service
3. Re-deploy the Bare Metal instance

8.3. THE BARE METAL SERVICE IS NOT GETTING THE RIGHT HOSTNAME

If the Bare Metal service is not getting the right hostname, it means that **cloud-init** is failing. To fix this, connect the Bare Metal subnet to a router in the OpenStack Networking service. The requests to the meta-data agent should now be routed correctly.

8.4. INVALID OPENSTACK IDENTITY SERVICE CREDENTIALS WHEN EXECUTING BARE METAL SERVICE COMMANDS

If you are having trouble authenticating to the Identity service, check the **identity_uri** parameter in the **ironic.conf** file and ensure that you remove the **/v2.0** from the **keystone** AdminURL. For example, set the **identity_uri** to **http://IP:PORT**.

8.5. HARDWARE ENROLLMENT

Issues with enrolled hardware can be caused by incorrect node registration details. Ensure that property names and values have been entered correctly. Incorrect or mistyped property names will be successfully added to the node's details, but will be ignored.

Update a node's details. This example updates the amount of memory the node is registered to use to 2 GB:

```
$ openstack baremetal node set --property memory_mb=2048 NODE_UUID
```

8.6. NO VALID HOST ERRORS

If the Compute scheduler cannot find a suitable Bare Metal node on which to boot an instance, a

NoValidHost error can be seen in `/var/log/nova/nova-conductor.log` or immediately upon launch failure in the dashboard. This is usually caused by a mismatch between the resources Compute expects and the resources the Bare Metal node provides.

1. Check the hypervisor resources that are available:

```
$ openstack hypervisor stats show
```

The resources reported here should match the resources that the Bare Metal nodes provide.

2. Check that Compute recognizes the Bare Metal nodes as hypervisors:

```
$ openstack hypervisor list
```

The nodes, identified by UUID, should appear in the list.

3. Check the details for a Bare Metal node:

```
$ openstack baremetal node list
$ openstack baremetal node show NODE_UUID
```

Verify that the node's details match those reported by Compute.

4. Check that the selected flavor does not exceed the available resources of the Bare Metal nodes:

```
$ openstack flavor show FLAVOR_NAME
```

5. Check the output of **openstack baremetal node list** to ensure that Bare Metal nodes are not in maintenance mode. Remove maintenance mode if necessary:

```
$ openstack baremetal node maintenance unset NODE_UUID
```

6. Check the output of **openstack baremetal node list** to ensure that Bare Metal nodes are in an **available** state. Move the node to **available** if necessary:

```
$ openstack baremetal node provide NODE_UUID
```

8.7. TROUBLESHOOTING IDRAC ISSUES

Redfish management interface fails to set boot device

When you use the **idrac-redfish** management interface with certain iDRAC firmware versions and attempt to set the boot device on a bare metal server with UEFI boot, iDRAC returns the following error:

```
Unable to Process the request because the value entered for the
parameter Continuous is not supported by the implementation.
```

If you encounter this issue, set the **force_persistent_boot_device** parameter in the **driver-info** on the node to **Never**:

```
openstack baremetal node set --driver-info force_persistent_boot_device=Never ${node_uuid}
```

Timeout when powering off

Some servers can be too slow when powering off, and time out. The default retry count is **6**, which results in a 30 second timeout. To increase the timeout duration to 90 seconds, set the **ironic::agent::rpc_response_timeout** value to **18** in the undercloud hieradata overrides file and re-run the **openstack undercloud install** command:

```
ironic::agent::rpc_response_timeout: 18
```

Vendor passthrough timeout

When iDRAC is not available to execute vendor passthrough commands, these commands take too long and time out:

```
openstack baremetal node passthru call --http-method GET \  
aed58dca-1b25-409a-a32f-3a817d59e1e0 list_unfinished_jobs  
Timed out waiting for a reply to message ID 547ce7995342418c99ef1ea4a0054572 (HTTP 500)
```

To increase the timeout duration for messaging, increase the value of the **ironic::default::rpc_response_timeout** parameter in the undercloud hieradata overrides file and re-run the **openstack undercloud install** command:

```
ironic::default::rpc_response_timeout: 600
```

APPENDIX A. BARE METAL DRIVERS

A bare metal node can be configured to use one of the drivers enabled in the Bare Metal service. Each driver is made up of a provisioning method and a power management type. Some drivers require additional configuration. Each driver described in this section uses PXE for provisioning; drivers are listed by their power management type.

You can add drivers with the **IronicEnabledHardwareTypes** parameter in your **ironic.yaml** file. By default, **ipmi**, **redfish**, **idrac** and **ilo** are enabled.

For the full list of supported plug-ins and drivers, see [Component, Plug-In, and Driver Support in Red Hat OpenStack Platform](#).

A.1. INTELLIGENT PLATFORM MANAGEMENT INTERFACE (IPMI)

IPMI is an interface that provides out-of-band remote management features, including power management and server monitoring. To use this power management type, all Bare Metal service nodes require an IPMI that is connected to the shared Bare Metal network. Enable the **ipmi** driver, and set the following information in the node's **driver_info**:

- **ipmi_address** - The IP address of the IPMI NIC.
- **ipmi_username** - The IPMI user name.
- **ipmi_password** - The IPMI password.

A.2. REDFISH

A standard RESTful API for IT infrastructure developed by the Distributed Management Task Force (DMTF)

- **redfish_username** - The Redfish username.
- **redfish_password** - The Redfish password.
- **redfish_address** - The IP address of the Redfish controller.
- **redfish_system_id** - The canonical path to the system resource. This path should include the root service, version, and the path/unique ID for the system. For example: **/redfish/v1/Systems/CX34R87**.
- **redfish_verify_ca** - Either a Boolean value, a path to a CA_BUNDLE file, or a directory with certificates of trusted CAs. If set to **True** the driver verifies the host certificates. If **False** the driver ignores verifying the SSL certificate. If set to a path, the driver uses the specified certificate or one of the certificates in the directory. Defaults to **True**.

A.3. DELL REMOTE ACCESS CONTROLLER (DRAC)

DRAC is an interface that provides out-of-band remote management features, including power management and server monitoring. To use this power management type, all Bare Metal service nodes require a DRAC that is connected to the shared Bare Metal network. Enable the **idrac** driver, and set the following information in the node's **driver_info**:

- **drac_address** - The IP address of the DRAC NIC.

- **drac_username** - The DRAC user name.
- **drac_password** - The DRAC password.

A.4. INTEGRATED REMOTE MANAGEMENT CONTROLLER (iRMC)

iRMC from Fujitsu is an interface that provides out-of-band remote management features including power management and server monitoring. To use this power management type on a Bare Metal service node, the node requires an iRMC interface that is connected to the shared Bare Metal network. Enable the **irmc** driver, and set the following information in the node's **driver_info**:

- **irmc_address** - The IP address of the iRMC interface NIC.
- **irmc_username** - The iRMC user name.
- **irmc_password** - The iRMC password.

To use IPMI to set the boot mode or SCCI to get sensor data, you must complete the following additional steps:

1. Enable the sensor method in *ironic.conf*:

```
$ openstack-config --set /etc/ironic/ironic.conf \
  irmc sensor_method METHOD
```

Replace *METHOD* with **scci** or **ipmitool**.

2. If you enabled SCCI, install the **python-scciclient** package:

```
# dnf install python-scciclient
```

3. Restart the Bare Metal conductor service:

```
# systemctl restart openstack-ironic-conductor.service
```

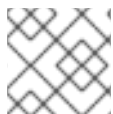

NOTE

To use the iRMC driver, iRMC S4 or higher is required.

A.5. INTEGRATED LIGHTS-OUT (iLO)

iLO from Hewlett-Packard is an interface that provides out-of-band remote management features including power management and server monitoring. To use this power management type, all Bare Metal nodes require an iLO interface that is connected to the shared Bare Metal network. Enable the **ilo** driver, and set the following information in the node's **driver_info**:

- **ilo_address** - The IP address of the iLO interface NIC.
- **ilo_username** - The iLO user name.
- **ilo_password** - The iLO password.

You must also install the **python-proliantutils** package and restart the Bare Metal conductor service:

```
# dnf install python-proliantutils
# systemctl restart openstack-ironic-conductor.service
```

A.6. CONVERTING TO NEXT GENERATION POWER MANAGEMENT DRIVERS

Red Hat OpenStack Platform now uses next generation drivers, also known as *hardware types*, that replace older drivers.

The following table shows an analogous comparison between older drivers and their next generation hardware type equivalent:

Old Driver	New Hardware Type
<code>pxe_ipmitool</code>	<code>ipmi</code>
<code>pxe_drac</code>	<code>idrac</code>
<code>pxe_ilo</code>	<code>ilo</code>
<code>pxe_irmc</code>	<code>irmc</code>
<code>fake_pxe</code>	<code>fake-hardware</code>

In OpenStack Platform 15, these older drivers have been removed and are no longer accessible. You must change to hardware types **before** upgrading to OpenStack Platform 15.

Procedure

1. Check the current list of hardware types enabled:

```
$ source ~/overcloud
$ openstack baremetal driver list --type dynamic
```

2. If you use a hardware type driver that is not enabled, enable the driver using the **IronicEnabledHardwareTypes** parameter in an environment file:

```
parameter_defaults:
  IronicEnabledHardwareTypes: ipmi,redfish,idrac
```

3. Save the file and run your overcloud deployment command:

```
$ openstack overcloud deploy -e [ENVIRONMENT_FILE] -r [ROLES_DATA] -n
[NETWORK_DATA]
```

Ensure that you include all environment and data files relevant to your overcloud.

4. Run the following commands, substituting the **OLDDRIVER** and **NEWDRIVER** variables for your power management type:

```
$ source ~/overcloud
$ OLDDRIVER="pxe_ipmitool"
$ NEWDRIVER="ipmi"
$ for NODE in $(openstack baremetal node list --driver $OLDDRIVER -c UUID -f value) ; do
openstack baremetal node set $NODE --driver $NEWDRIVER; done
```