



Red Hat OpenStack Platform 15-Beta

Bare Metal Provisioning

Install, Configure, and Use the Bare Metal Service (Ironic)

Red Hat OpenStack Platform 15-Beta Bare Metal Provisioning

Install, Configure, and Use the Bare Metal Service (Ironic)

OpenStack Team
rhos-docs@redhat.com

Legal Notice

Copyright © 2019 Red Hat, Inc.

The text of and illustrations in this document are licensed by Red Hat under a Creative Commons Attribution–Share Alike 3.0 Unported license ("CC-BY-SA"). An explanation of CC-BY-SA is available at

<http://creativecommons.org/licenses/by-sa/3.0/>

. In accordance with CC-BY-SA, if you distribute this document or an adaptation of it, you must provide the URL for the original version.

Red Hat, as the licensor of this document, waives the right to enforce, and agrees not to assert, Section 4d of CC-BY-SA to the fullest extent permitted by applicable law.

Red Hat, Red Hat Enterprise Linux, the Shadowman logo, the Red Hat logo, JBoss, OpenShift, Fedora, the Infinity logo, and RHCE are trademarks of Red Hat, Inc., registered in the United States and other countries.

Linux[®] is the registered trademark of Linus Torvalds in the United States and other countries.

Java[®] is a registered trademark of Oracle and/or its affiliates.

XFS[®] is a trademark of Silicon Graphics International Corp. or its subsidiaries in the United States and/or other countries.

MySQL[®] is a registered trademark of MySQL AB in the United States, the European Union and other countries.

Node.js[®] is an official trademark of Joyent. Red Hat is not formally related to or endorsed by the official Joyent Node.js open source or commercial project.

The OpenStack[®] Word Mark and OpenStack logo are either registered trademarks/service marks or trademarks/service marks of the OpenStack Foundation, in the United States and other countries and are used with the OpenStack Foundation's permission. We are not affiliated with, endorsed or sponsored by the OpenStack Foundation, or the OpenStack community.

All other trademarks are the property of their respective owners.

Abstract

This guide provides procedures for installing, configuring, and using the Bare Metal service in the overcloud of a Red Hat OpenStack Platform environment.

Table of Contents

PREFACE	4
CHAPTER 1. ABOUT THE BARE METAL SERVICE	5
CHAPTER 2. PLANNING FOR BARE METAL PROVISIONING	7
2.1. INSTALLATION ASSUMPTIONS	7
2.2. HARDWARE REQUIREMENTS	7
2.3. NETWORKING REQUIREMENTS	7
2.3.1. The Default Bare Metal Network	8
2.3.2. The Custom Composable Network	9
CHAPTER 3. DEPLOYING AN OVERCLOUD WITH THE BARE METAL SERVICE	10
3.1. CREATING THE IRONIC TEMPLATE	10
3.2. NETWORK CONFIGURATION	10
3.2.1. Configuring a Custom Provisioning Network	11
3.3. EXAMPLE TEMPLATES	12
3.4. ENABLING IRONIC INTROSPECTION IN THE OVERCLOUD	13
3.5. DEPLOYING THE OVERCLOUD	13
3.6. TESTING THE BARE METAL SERVICE	14
CHAPTER 4. CONFIGURING FOR THE BARE METAL SERVICE AFTER DEPLOYMENT	15
4.1. CONFIGURING OPENSTACK NETWORKING	15
4.1.1. Configuring OpenStack Networking to Communicate with the Bare Metal Service on a flat Bare Metal Network	15
4.1.2. Configuring OpenStack Networking to Communicate with the Bare Metal Service on a Custom Composable Bare Metal Network	16
4.2. CONFIGURING NODE CLEANING	17
4.2.1. Manual Node Cleaning	17
4.3. CREATING THE BARE METAL FLAVOR	18
4.4. CREATING THE BARE METAL IMAGES	18
4.4.1. Preparing the Deploy Images	19
4.4.2. Preparing the User Image	19
4.4.3. Disk image environment variables	19
4.4.4. Installing the User Image	21
4.5. UNDERSTANDING THE DEPLOY PROCESS	22
Prerequisites	22
Workflow	22
4.5.1. Configuring the Direct Deploy Interface	23
Procedure	23
4.6. ADDING PHYSICAL MACHINES AS BARE METAL NODES	24
4.6.1. Enrolling a Bare Metal Node With an Inventory File	24
4.6.2. Enrolling a Bare Metal Node Manually	26
4.7. USING HOST AGGREGATES TO SEPARATE PHYSICAL AND VIRTUAL MACHINE PROVISIONING	29
CHAPTER 5. ADMINISTERING BARE METAL NODES	31
5.1. LAUNCHING AN INSTANCE USING THE COMMAND LINE INTERFACE	31
5.2. LAUNCH AN INSTANCE USING THE DASHBOARD	31
5.3. CONFIGURE PORT GROUPS IN THE BARE METAL PROVISIONING SERVICE	32
5.3.1. Configure the Switches	32
5.3.2. Configure Port Groups in the Bare Metal Provisioning Service	33
5.4. DETERMINING THE HOST TO IP ADDRESS MAPPING	33
5.5. ATTACHING AND DETACHING A VIRTUAL NETWORK INTERFACE	35
5.6. CONFIGURING NOTIFICATIONS FOR THE BARE METAL SERVICE	37

5.7. CONFIGURING AUTOMATIC POWER FAULT RECOVERY	38
5.8. INTROSPECTING OVERCLOUD NODES	39
CHAPTER 6. USE BARE METAL NODES AS INSTANCES	40
6.1. PREREQUISITES	40
6.2. GENERATE THE IMAGES	40
6.3. CREATE THE CLUSTER	40
CHAPTER 7. TROUBLESHOOTING THE BARE METAL SERVICE	42
7.1. PXE BOOT ERRORS	42
7.2. LOGIN ERRORS AFTER THE BARE METAL NODE BOOTS	43
7.3. THE BARE METAL SERVICE IS NOT GETTING THE RIGHT HOSTNAME	44
7.4. INVALID OPENSTACK IDENTITY SERVICE CREDENTIALS WHEN EXECUTING BARE METAL SERVICE COMMANDS	44
7.5. HARDWARE ENROLLMENT	44
7.6. NO VALID HOST ERRORS	44
APPENDIX A. BARE METAL DRIVERS	46
A.1. INTELLIGENT PLATFORM MANAGEMENT INTERFACE (IPMI)	46
A.2. REDFISH	46
A.3. DELL REMOTE ACCESS CONTROLLER (DRAC)	46
A.4. INTEGRATED REMOTE MANAGEMENT CONTROLLER (IRMC)	47
A.5. INTEGRATED LIGHTS-OUT (ILO)	47
A.6. CONVERTING TO NEXT GENERATION POWER MANAGEMENT DRIVERS	48

PREFACE

This document provides instructions for installing and configuring the Bare Metal service (ironic) in the overcloud, and using the service to provision and manage physical machines for end users.

The Bare Metal service components are also used by the Red Hat OpenStack Platform director, as part of the undercloud, to provision and manage the bare metal nodes that make up the OpenStack environment (the overcloud). For information on how the director uses the Bare Metal service, see [Director Installation and Usage](#).

CHAPTER 1. ABOUT THE BARE METAL SERVICE

The OpenStack Bare Metal service (ironic) provides the components required to provision and manage physical machines for end users. The Bare Metal service in the overcloud interacts with the following OpenStack services:

- OpenStack Compute (nova) provides scheduling, tenant quotas, IP assignment, and a user-facing API for virtual machine instance management, while the Bare Metal service provides the administrative API for hardware management.
- OpenStack Identity (keystone) provides request authentication and assists the Bare Metal service in locating other OpenStack services.
- OpenStack Image service (glance) manages images and image metadata.
- OpenStack Networking (neutron) provides DHCP and network configuration.
- OpenStack Object Storage (swift) is used by certain drivers to expose temporary URLs to images.

The Bare Metal service uses iPXE to provision physical machines. The following diagram outlines how the OpenStack services interact during the provisioning process when a user launches a new machine with the default drivers.

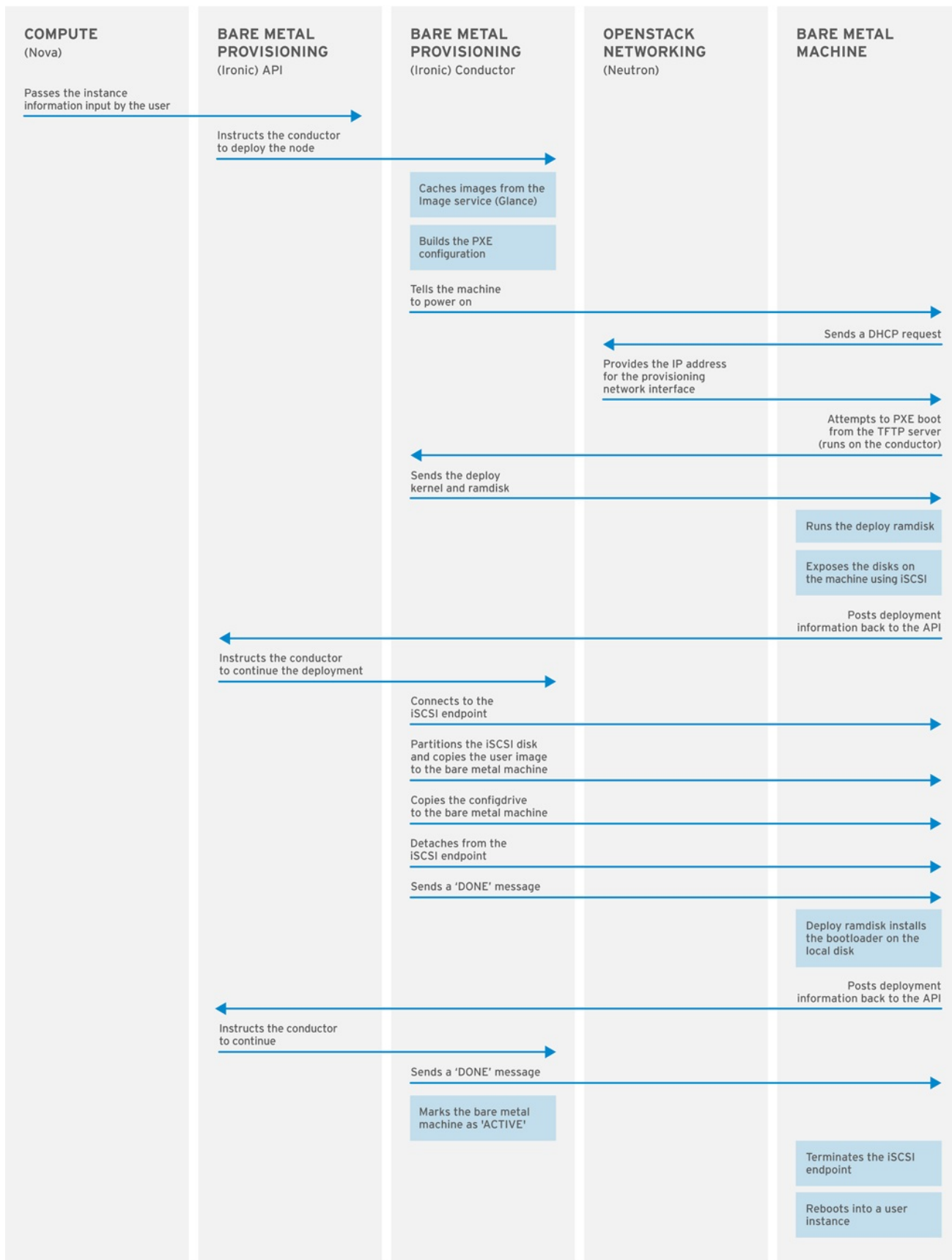

OPENSTACK_377593_1215

CHAPTER 2. PLANNING FOR BARE METAL PROVISIONING

This chapter outlines the requirements for configuring the Bare Metal service, including installation assumptions, hardware requirements, and networking requirements.

2.1. INSTALLATION ASSUMPTIONS

This guide assumes that you have installed the director on the undercloud node, and are ready to install the Bare Metal service along with the rest of the overcloud. For more information on installing the director, see [Installing the Undercloud](#).



NOTE

The Bare Metal service in the overcloud is designed for a trusted tenant environment, as the bare metal nodes have direct access to the control plane network of your OpenStack installation. If you implement a custom composable network for Ironic services in the overcloud, users do not need to access the control plane.

2.2. HARDWARE REQUIREMENTS

Overcloud Requirements

The hardware requirements for an overcloud with the Bare Metal service are the same as for the standard overcloud. For more information, see [Overcloud Requirements](#) in the *Director Installation and Usage* guide.

Bare Metal Machine Requirements

The hardware requirements for bare metal machines that will be provisioned vary depending on the operating system you are installing.

- For Red Hat Enterprise Linux 8, see the [Red Hat Enterprise Linux 8 Performing a standard RHEL installation](#).
- For Red Hat Enterprise Linux 7, see the [Red Hat Enterprise Linux 7 Installation Guide](#).
- For Red Hat Enterprise Linux 6, see the [Red Hat Enterprise Linux 6 Installation Guide](#).

All bare metal machines that you want to provision require the following:

- A NIC to connect to the bare metal network.
- A power management interface (for example, IPMI) connected to a network reachable from the **ironic-conductor** service. By default, **ironic-conductor** runs on all of the controller nodes, unless you are using composable roles and running **ironic-conductor** elsewhere.
- PXE boot on the bare metal network. Disable PXE boot on all other NICs in the deployment.

2.3. NETWORKING REQUIREMENTS

The bare metal network:

This is a private network that the Bare Metal service uses for the following operations:

- The provisioning and management of bare metal machines on the overcloud.

- Cleaning bare metal nodes before and between deployments.
- Tenant access to the bare metal nodes.

The bare metal network provides DHCP and PXE boot functions to discover bare metal systems. This network must use a native VLAN on a trunked interface so that the Bare Metal service can serve PXE boot and DHCP requests.

You can configure the bare metal network in two ways:

- Use a flat bare metal network for Ironic Conductor services. This network must route to the Ironic services on the control plane. If you define an isolated bare metal network, the bare metal nodes cannot PXE boot.
- Use a custom composable network to implement Ironic services in the overcloud.



NOTE

The Bare Metal service in the overcloud is designed for a trusted tenant environment, as the bare metal nodes have direct access to the control plane network of your OpenStack installation. If you implement a custom composable network for Ironic services in the overcloud, users do not need to access the control plane.

Network tagging:

- The control plane network (the director's provisioning network) is always untagged.
- The bare metal network must be untagged for provisioning, and must also have access to the Ironic API.
- Other networks may be tagged.

Overcloud controllers:

The controller nodes with the Bare Metal service must have access to the bare metal network.

Bare metal nodes:

The NIC which the bare metal node is configured to PXE-boot from must have access to the bare metal network.

2.3.1. The Default Bare Metal Network

In this architecture, the bare metal network is separated from the control plane network. The bare metal network is a flat network that also acts as the tenant network.

- The bare metal network is created by the OpenStack operator. This network requires a route to the director provisioning network.
- Ironic users have access to the public OpenStack APIs, and to the bare metal network. Since the bare metal network is routed to the director's provisioning network, users also have indirect access to the control plane.
- Ironic uses the bare metal network for node cleaning.

Default bare metal network architecture diagram

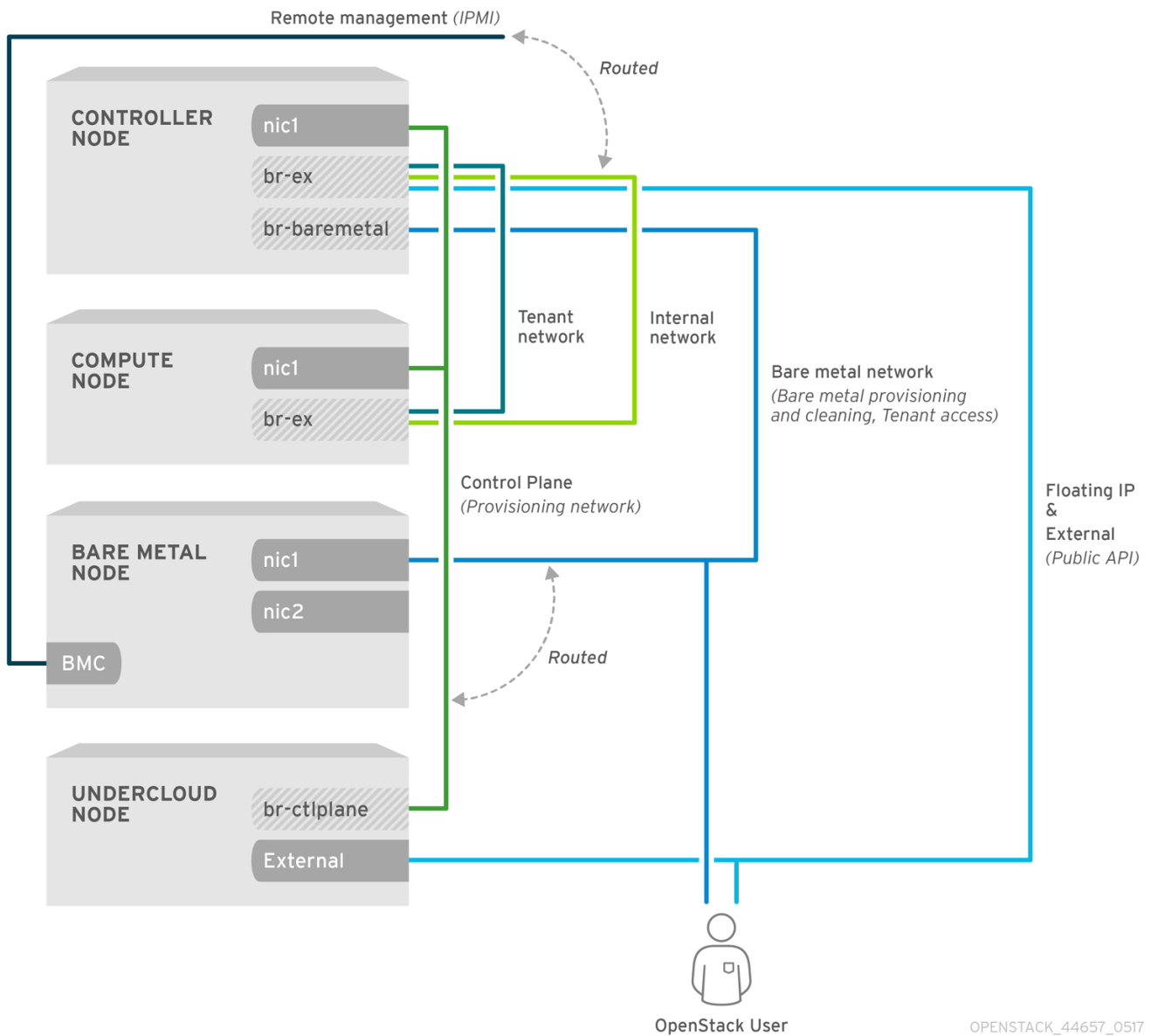

2.3.2. The Custom Composable Network

In this architecture, the bare metal network is a custom composable network that does not have access to the control plane. Creating this network might be preferable if you want to limit access to the control plane.

- The custom composable bare metal network is created by the OpenStack operator.
- Ironic users have access to the public OpenStack APIs, and to the custom composable bare metal network.
- Ironic uses the custom composable bare metal network for node cleaning. :leveloffset: +1

CHAPTER 3. DEPLOYING AN OVERCLOUD WITH THE BARE METAL SERVICE

For full details about overcloud deployment with the director, see [Director Installation and Usage](#). This chapter covers only the deployment steps specific to ironic.

3.1. CREATING THE IRONIC TEMPLATE

Use an environment file to deploy the overcloud with the Bare Metal service enabled. A template is located on the director node at `/usr/share/openstack-tripleo-heat-templates/environments/services/ironic.yaml`.

Filling in the template

Additional configuration can be specified either in the provided template or in an additional yaml file, for example `~/templates/ironic.yaml`.

- For a hybrid deployment with both bare metal and virtual instances, you must add **AggregateInstanceExtraSpecsFilter** to the list of **NovaSchedulerDefaultFilters**. If you have not set **NovaSchedulerDefaultFilters** anywhere, you can do so in `ironic.yaml`. For an example, see [Section 3.3, "Example Templates"](#).



NOTE

If you are using SR-IOV, `NovaSchedulerDefaultFilters` is already set in `tripleo-heat-templates/environments/neutron-sriov.yaml`. Append **AggregateInstanceExtraSpecsFilter** to this list.

- The type of cleaning that occurs before and between deployments is set by **IronicCleaningDiskErase**. By default, this is set to 'full' by `deployment/ironic/ironic-conductor-container-puppet.yaml`. Setting this to 'metadata' can substantially speed up the process, as it cleans only the partition table, however, since the deployment will be less secure in a multi-tenant environment, you should do this only in a trusted tenant environment.
- You can add drivers with the **IronicEnabledDrivers** parameter. By default, `ipmi`, `idrac` and `ilo` are enabled.

For a full list of configuration parameters, see the [Bare Metal](#) section in the Overcloud Parameters guide.

3.2. NETWORK CONFIGURATION

If you use the default flat bare metal network, you must create a bridge **br-baremetal** for ironic to use. You can specify this in an additional template:

`~/templates/network-environment.yaml`

```
parameter_defaults:
  NeutronBridgeMappings: datacentre:br-ex,baremetal:br-baremetal
  NeutronFlatNetworks: datacentre,baremetal
```

You can configure this bridge either in the provisioning network (control plane) of the controllers, so that you can reuse this network as the bare metal network, or add a dedicated network. The configuration requirements are the same, however the bare metal network cannot be VLAN-tagged, as

it is used for provisioning.

~/templates/nic-configs/controller.yaml

```
network_config:
-
  type: ovs_bridge
  name: br-baremetal
  use_dhcp: false
  members:
-
  type: interface
  name: eth1
```



NOTE

The Bare Metal service in the overcloud is designed for a trusted tenant environment, as the bare metal nodes have direct access to the control plane network of your OpenStack installation.

3.2.1. Configuring a Custom Provisioning Network

The default flat provisioning network can introduce security concerns in a customer environment as a tenant can interfere with the undercloud network. To prevent this risk, you can configure a custom composable bare metal provisioning network for ironic services that does not have access to the control plane:

1. Configure the shell to access Identity as the administrative user:

```
$ source ~/overcloudrc
```

2. Copy the **network_data.yaml** file:

```
(undercloud) [stack@host01 ~]$ cp /usr/share/openstack-tripleo-heat-templates/network_data.yaml .
```

3. Edit the new **network_data.yaml** file and add a new network for Overcloud provisioning:

```
# custom network for Overcloud provisioning
- name: OcProvisioning
  name_lower: oc_provisioning
  vip: true
  vlan: 205
  ip_subnet: '172.23.3.0/24'
  allocation_pools: [{'start': '172.23.3.10', 'end': '172.23.3.200'}]
```

4. Update the **network_environments.yaml** and **nic-configs/controller.yaml** files to use the new network.
 - a. In the **network_environments.yaml** file, add Vlan and remap Ironic networks:

```
ServiceNetMap:
  IronicApiNetwork: oc_provisioning
  IronicNetwork: oc_provisioning
```

-
- b. In the **nic-configs/controller.yaml** file, add an interface and necessary parameters:

```
$network_config:
  - type: vlan
    vlan_id:
      get_param: OcProvisioningNetworkVlanID
    addresses:
      - ip_netmask:
          get_param: OcProvisioningIpSubnet
```

5. Copy the **roles_data.yaml** file:

```
(undercloud) [stack@host01 ~]$ cp /usr/share/openstack-tripleo-heat-templates/roles_data.yaml .
```

6. Edit the new **roles_data.yaml** and add the new network for the controller:

```
networks:
  ...
  - OcProvisioning
```

7. Include the new **network_data.yaml** and **roles_data.yaml** files in the deploy command:

```
-n /home/stack/network_data.yaml \
-r /home/stack/roles_data.yaml \
```

3.3. EXAMPLE TEMPLATES

The following is an example template file. This file might not meet the requirements of your environment. Before using this example, ensure that it does not interfere with any existing configuration in your environment.

~/templates/ironic.yaml

```
parameter_defaults:

  NovaSchedulerDefaultFilters:
    - RetryFilter
    - AggregateInstanceExtraSpecsFilter
    - AvailabilityZoneFilter
    - RamFilter
    - DiskFilter
    - ComputeFilter
    - ComputeCapabilitiesFilter
    - ImagePropertiesFilter

  IronicCleaningDiskErase: metadata
```

In this example:

- The **AggregateInstanceExtraSpecsFilter** allows both virtual and bare metal instances, for a hybrid deployment.

- Disk cleaning that is done before and between deployments erases only the partition table (metadata).

3.4. ENABLING IRONIC INTROSPECTION IN THE OVERCLOUD

To enable Bare Metal introspection in the Overcloud, include both the **ironic.yaml** and the **ironic-inspector.yaml** environment files in the deploy command. You can find these files in the **/usr/share/openstack-tripleo-heat-templates/environments/services** directory. Use the following example to include configuration details for the ironic inspector that correspond to your environment:

```
parameter_defaults:
  IronicInspectorSubnets:
    - ip_range: 192.168.101.201,192.168.101.250
  IPAImageURLs: ["http://192.168.24.1:8088/agent.kernel",
"http://192.168.24.1:8088/agent.ramdisk"]
  IronicInspectorInterface: 'br-baremetal'
```

IronicInspectorSubnets

This parameter can contain multiple ranges and works with both spine and leaf.

IPAImageURLs

This parameter contains details about the IPA kernel and ramdisk. In most cases, you can use the same images that you use on the undercloud. If you omit this parameter, place alternatives on each controller.

IronicInspectorInterface

Use this parameter to specify the bare metal network interface.



NOTE

If you use a composable Ironic or IronicConductor role, you must include the **IronicInspector** service in the Ironic role in your roles file.

```
ServicesDefault:
  OS::TripleO::Services::IronicInspector
```

3.5. DEPLOYING THE OVERCLOUD

To enable the Bare Metal service, include your ironic environment files with the **-e** option when deploying or redeploying the overcloud, along with the rest of your overcloud configuration.

For example:

```
$ openstack overcloud deploy \
--templates \
-e ~/templates/node-info.yaml \
-e /usr/share/openstack-tripleo-heat-templates/environments/network-isolation.yaml \
-e ~/templates/network-environment.yaml \
-e /usr/share/openstack-tripleo-heat-templates/environments/services/ironic.yaml \
-e ~/templates/ironic.yaml \
```

For more information about deploying the overcloud, see [Creating the Overcloud with the CLI Tools](#) and [Including Environment Files in Overcloud Creation](#) .

3.6. TESTING THE BARE METAL SERVICE

You can use the OpenStack Integration Test Suite to validate your Red Hat OpenStack deployment. For more information, see the [OpenStack Integration Test Suite Guide](#) .

Additional Ways to Verify the Bare Metal Service:

1. Configure the shell to access Identity as the administrative user:

```
$ source ~/overcloudrc
```

2. Check that the **nova-compute** service is running on the controller nodes:

```
$ openstack compute service list -c Binary -c Host -c Status
```

3. If you have changed the default ironic drivers, ensure that the required drivers are enabled:

```
$ openstack baremetal driver list
```

4. Ensure that the ironic endpoints are listed:

```
$ openstack catalog list
```

CHAPTER 4. CONFIGURING FOR THE BARE METAL SERVICE AFTER DEPLOYMENT

This section describes the steps necessary to configure your overcloud after deployment.

4.1. CONFIGURING OPENSTACK NETWORKING

Configure OpenStack Networking to communicate with the Bare Metal service for DHCP, PXE boot, and other requirements. You can configure the bare metal network in two ways:

- Use a flat bare metal network for Ironic Conductor services. This network must route to the Ironic services on the control plane network.
- Use a custom composable network to implement Ironic services in the overcloud.

Follow the procedures in this section to configure OpenStack Networking for a single flat network for provisioning onto bare metal, or to configure a new composable network that does not rely on an unused isolated network or a flat network. The configuration uses the ML2 plug-in and the Open vSwitch agent.

Perform all steps in the following procedure on the server that hosts the OpenStack Networking service, while logged in as the **root** user.

4.1.1. Configuring OpenStack Networking to Communicate with the Bare Metal Service on a flat Bare Metal Network

1. Configure the shell to access Identity as the administrative user:

```
$ source ~/overcloudrc
```

2. Create the flat network over which to provision bare metal instances:

```
$ openstack network create \
  --provider-network-type flat \
  --provider-physical-network baremetal \
  --share NETWORK_NAME
```

Replace *NETWORK_NAME* with a name for this network. The name of the physical network over which the virtual network is implemented (in this case **baremetal**) was set earlier in the `~/templates/network-environment.yaml` file, with the parameter **NeutronBridgeMappings**.

3. Create the subnet on the flat network:

```
$ openstack subnet create \
  --network NETWORK_NAME \
  --subnet-range NETWORK_CIDR \
  --ip-version 4 \
  --gateway GATEWAY_IP \
  --allocation-pool start=START_IP,end=END_IP \
  --dhcp SUBNET_NAME
```

Replace the following values:

- Replace *SUBNET_NAME* with a name for the subnet.

- Replace *NETWORK_NAME* with the name of the provisioning network that you created in the previous step.
 - Replace *NETWORK_CIDR* with the Classless Inter-Domain Routing (CIDR) representation of the block of IP addresses that the subnet represents. The block of IP addresses specified by the range starting with *START_IP* and ending with *END_IP* must fall within the block of IP addresses specified by *NETWORK_CIDR*.
 - Replace *GATEWAY_IP* with the IP address or host name of the router interface that acts as the gateway for the new subnet. This address must be within the block of IP addresses specified by *NETWORK_CIDR*, but outside of the block of IP addresses specified by the range starting with *START_IP* and ending with *END_IP*.
 - Replace *START_IP* with the IP address that denotes the start of the range of IP addresses within the new subnet from which floating IP addresses will be allocated.
 - Replace *END_IP* with the IP address that denotes the end of the range of IP addresses within the new subnet from which floating IP addresses will be allocated.
4. Create a router for the network and subnet to ensure that the OpenStack Networking Service serves metadata requests:

```
$ openstack router create ROUTER_NAME
```

Replace **ROUTER_NAME** with a name for the router.

5. Attach the network to the new router:

```
$ openstack router add network ROUTER_NAME NETWORK
```

Replace *ROUTER_NAME* with the name of your router, and replace *NETWORK* with the ID or name of the network that you created previously.

6. Attach the subnet to the new router:

```
$ openstack router add subnet ROUTER_NAME BAREMETAL_SUBNET
```

Replace *ROUTER_NAME* with the name of your router and *BAREMETAL_SUBNET* with the ID or name of the subnet that you created previously. This allows the metadata requests from **cloud-init** to be served and the node configured.

4.1.2. Configuring OpenStack Networking to Communicate with the Bare Metal Service on a Custom Composable Bare Metal Network

1. Create a vlan network with a VlanID that matches the **OcProvisioning** network that you create during deployment. Name the new network **provisioning** to match the default name of the cleaning network.

```
(overcloud) [stack@host01 ~]$ openstack network create \
  --share \
  --provider-network-type vlan \
  --provider-physical-network datacentre \
  --provider-segment 205 provisioning
```

If the name of the overcloud network is not **provisioning**, log in to the controller and run the following commands to rename and restart the network:

```
heat-admin@overcloud-controller-0 ~]$ sudo vi /var/lib/config-data/puppet-generated/ironic/etc/ironic/ironic.conf
```

```
heat-admin@overcloud-controller-0 ~]$ sudo podman restart ironic_conductor
```

4.2. CONFIGURING NODE CLEANING

By default, the Bare Metal service is set to use a network named **provisioning** for node cleaning. However, network names are not unique in OpenStack Networking, so it is possible for a tenant to create a network with the same name, causing a conflict with the Bare Metal service. Therefore, it is recommended to use the network UUID instead.

1. Configure cleaning by providing the provider network UUID on the controller running the Bare Metal Service:

```
~/templates/ironic.yaml
```

```
parameter_defaults:
  IronicCleaningNetwork: UUID
```

Replace *UUID* with the UUID of the bare metal network that you create in the previous steps.

You can find the UUID with the **openstack network show** command:

```
openstack network show NETWORK_NAME -f value -c id
```

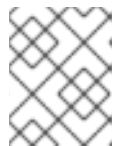

NOTE

You must perform this configuration after the initial overcloud deployment, because the UUID for the network is not available beforehand.

2. Apply the changes by redeploying the overcloud with the **openstack overcloud deploy** command as described in [Section 3.5, "Deploying the Overcloud"](#).
3. Uncomment the following line and replace **<None>** with the UUID of the bare metal network:

```
cleaning_network = <None>
```

4. Restart the Bare Metal service:

```
# systemctl restart openstack-ironic-conductor.service
```

Redeploying the overcloud with **openstack overcloud deploy** reverts any manual changes, so ensure that you have added the cleaning configuration to `~/templates/ironic.yaml` (described in the previous step) before you next use the **openstack overcloud deploy** command.

4.2.1. Manual Node Cleaning

To initiate node cleaning manually, the node must be in the **manageable** state.

Node cleaning has two modes:

Metadata only clean - Removes partitions from all disks on a given node. This is a faster clean cycle, but less secure since it erases only partition tables. Use this mode only on trusted tenant environments.

Full clean - Removes all data from all disks, using either ATA secure erase or by shredding. This can take several hours to complete.

To initiate a **metadata** clean:

```
$ openstack baremetal node clean UUID \
  --clean-steps [{"interface": "deploy", "step": "erase_devices_metadata"}]
```

To initiate a **full** clean:

```
$ openstack baremetal node clean UUID \
  --clean-steps [{"interface": "deploy", "step": "erase_devices"}]
```

Replace *UUID* with the UUID of the node that you want to clean.

After a successful cleaning, the node state returns to **manageable**. If the state is **clean failed**, inspect the **last_error** field for the cause of failure.

4.3. CREATING THE BARE METAL FLAVOR

You must create a flavor to use as a part of the deployment. The specifications (memory, CPU, and disk) of this flavor must be equal to or less than the hardware specifications of your bare metal node.

1. Configure the shell to access Identity as the administrative user:

```
$ source ~/overcloudrc
```

2. List existing flavors:

```
$ openstack flavor list
```

3. Create a new flavor for the Bare Metal service:

```
$ openstack flavor create \
  --id auto --ram RAM \
  --vcpus VCPU --disk DISK \
  --property baremetal=true \
  --public baremetal
```

Replace **RAM** with the amount of memory, **VCPU** with the number of vCPUs and **DISK** with the disk storage value. The property **baremetal** is used to distinguish bare metal from virtual instances.

4. Verify that the new flavor is created with the correct values:

```
$ openstack flavor list
```

4.4. CREATING THE BARE METAL IMAGES

The deployment requires two sets of images:

- The **deploy image** is used by the Bare Metal service to boot the bare metal node and copy a user image onto the bare metal node. The deploy image consists of the **kernel** image and the **ramdisk** image.
- The **user image** is the image deployed onto the bare metal node. The user image also has a **kernel** image and **ramdisk** image, but additionally, the user image contains a **main** image. The main image is either a root partition, or a whole-disk image.
 - A **whole-disk image** is an image that contains the partition table and boot loader. The Bare Metal service does not control the subsequent reboot of a node deployed with a whole-disk image as the node supports localboot.
 - A **root partition image** contains only the root partition of the operating system. If you use a root partition, after the deploy image is loaded into the Image service, you can set the deploy image as the node boot image in the node properties. A subsequent reboot of the node uses netboot to pull down the user image.

The examples in this section use a root partition image to provision bare metal nodes.

4.4.1. Preparing the Deploy Images

You do not have to create the deploy image as it was already used when the overcloud was deployed by the undercloud. The deploy image consists of two images - the kernel image and the ramdisk image:

```
ironic-python-agent.kernel
ironic-python-agent.initramfs
```

These images are often in the home directory, unless you have deleted them, or unpacked them elsewhere. If they are not in the home directory, and you still have the **rhosp-director-images-ipa** package installed, these images are in the **/usr/share/rhosp-director-images/ironic-python-agent*.tar** file.

Extract the images and upload them to the Image service:

```
$ openstack image create \
  --container-format aki \
  --disk-format aki \
  --public \
  --file ./ironic-python-agent.kernel bm-deploy-kernel
$ openstack image create \
  --container-format ari \
  --disk-format ari \
  --public \
  --file ./ironic-python-agent.initramfs bm-deploy-ramdisk
```

4.4.2. Preparing the User Image

The final image that you need is the user image that will be deployed on the bare metal node. User images also have a kernel and ramdisk, along with a main image. To download and install these packages, you must first configure whole disk image environment variables to suit your requirements.

4.4.3. Disk image environment variables

As a part of the disk image building process, the director requires a base image and registration details to obtain packages for the new overcloud image. Define these attributes with the following Linux environment variables.

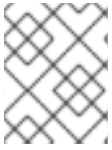
**NOTE**

The image building process temporarily registers the image with a Red Hat subscription and unregisters the system once the image building process completes.

To build a disk image, set Linux environment variables that suit your environment and requirements:

DIB_LOCAL_IMAGE

Sets the local image that you want to use as the basis for your whole disk image.

REG_ACTIVATION_KEY

Use an activation key instead of login details as part of the registration process.

REG_AUTO_ATTACH

Defines whether to attach the most compatible subscription automatically.

REG_BASE_URL

The base URL of the content delivery server containing packages for the image. The default Customer Portal Subscription Management process uses **https://cdn.redhat.com**. If you use a Red Hat Satellite 6 server, set this parameter to the base URL of your Satellite server.

REG_ENVIRONMENT

Registers to an environment within an organization.

REG_METHOD

Sets the method of registration. Use **portal** to register a system to the Red Hat Customer Portal. Use **satellite** to register a system with Red Hat Satellite 6.

REG_ORG

The organization where you want to register the images.

REG_POOL_ID

The pool ID of the product subscription information.

REG_PASSWORD

Gives the password for the user account that registers the image.

REG_REPOS

A comma-separated string of repository names. Each repository in this string is enabled through **subscription-manager**.

REG_SAT_URL

The base URL of the Satellite server to register Overcloud nodes. Use the Satellite's HTTP URL and not the HTTPS URL for this parameter. For example, use <http://satellite.example.com> and not <https://satellite.example.com>.

REG_SERVER_URL

Gives the hostname of the subscription service to use. The default is for the Red Hat Customer Portal at **subscription.rhn.redhat.com**. If using a Red Hat Satellite 6 server, set this parameter to the hostname of your Satellite server.

REG_USER

Gives the user name for the account that registers the image.

4.4.4. Installing the User Image

1. Download the Red Hat Enterprise Linux KVM guest image from the [Customer Portal](#) (requires login).
2. Define `DIB_LOCAL_IMAGE` as the downloaded image:

```
$ export DIB_LOCAL_IMAGE=rhel-8.0-x86_64-kvm.qcow2
```

3. Set your registration information. If you use Red Hat Customer Portal, you must configure the following information:

```
$ export REG_USER='USER_NAME'
$ export REG_PASSWORD='PASSWORD'
$ export REG_AUTO_ATTACH=true
$ export REG_METHOD=portal
$ export https_proxy='IP_address:port' (if applicable)
$ export http_proxy='IP_address:port' (if applicable)
```

If you use Red Hat Satellite, you must configure the following information:

```
$ export REG_USER='USER_NAME'
$ export REG_PASSWORD='PASSWORD'
$ export REG_SAT_URL='<SATELLITE URL>'
$ export REG_ORG='<SATELLITE ORG>'
$ export REG_ENV='<SATELLITE ENV>'
$ export REG_METHOD='<METHOD>'
```

If you have any offline repositories, you can define `DIB_YUM_REPO_CONF` as local repository configuration:

```
$ export DIB_YUM_REPO_CONF='<path-to-local-repository-config-file>'
```

4. Create the user images using the **diskimage-builder** tool:

```
$ disk-image-create rhel8 baremetal -o rhel-image
```

This command extracts the kernel as **rhel-image.vmlinuz** and initial ramdisk as **rhel-image.initrd**.

5. Upload the images to the Image service:

```
$ KERNEL_ID=$(openstack image create \
  --file rhel-image.vmlinuz --public \
  --container-format aki --disk-format aki \
  -f value -c id rhel-image.vmlinuz)
$ RAMDISK_ID=$(openstack image create \
  --file rhel-image.initrd --public \
  --container-format ari --disk-format ari \
  -f value -c id rhel-image.initrd)
$ openstack image create \
  --file rhel-image.qcow2 --public \
  --container-format bare \
  --disk-format qcow2 \
```

```
--property kernel_id=$KERNEL_ID \  
--property ramdisk_id=$RAMDISK_ID \  
rhel-image
```

4.5. UNDERSTANDING THE DEPLOY PROCESS

Deploy interfaces have a critical role in the provisioning process. Deploy interfaces orchestrate the deployment and define the mechanism for transferring the image to the target disk.

Prerequisites

- Dependent packages configured on the bare metal service nodes that run **ironic-conductor**.
- OpenStack Compute (nova) must be configured to use the bare metal service endpoint.
- Flavors must be created for the available hardware, and nova must boot the new node from the correct flavor.
- Images must be available in Glance:
 - bm-deploy-kernel
 - bm-deploy-ramdisk
 - user-image
 - user-image-vmlinuz
 - user-image-initrd
- Hardware to enroll with the Ironic API service.

Workflow

Use the following example workflow to understand the standard deploy process. Depending on the ironic driver interfaces that you use, some of the steps might differ:

1. The Nova scheduler receives a boot instance request from the Nova API.
2. The Nova scheduler identifies the relevant hypervisor and identifies the target physical node.
3. The Nova compute manager claims the resources of the selected hypervisor.
4. The Nova compute manager creates unbound tenant virtual interfaces (VIFs) in the Networking service according to the network interfaces that the nova boot request specifies.
5. Nova compute invokes **driver.spawn** from the Nova compute virt layer to create a spawn task that contains all of the necessary information. During the spawn process, the virt driver completes the following steps.
 - a. Updates the target ironic node with information about the deploy image, instance UUID, requested capabilities, and flavor properties.
 - b. Calls the ironic API to validate the power and deploy interfaces of the target node.
 - c. Attaches the VIFs to the node. Each neutron port can be attached to any ironic port or group. Port groups have higher priority than ports.

- d. Generates config drive.
6. The Nova ironic virt driver issues a deploy request with the Ironic API to the Ironic conductor that services the bare metal node.
7. Virtual interfaces are plugged in and the Neutron API updates DHCP to configure PXE/TFTP options.
8. The ironic node boot interface prepares (i)PXE configuration and caches the deploy kernel and ramdisk.
9. The ironic node management interface issues commands to enable network boot of the node.
10. The ironic node deploy interface caches the instance image, kernel, and ramdisk, if necessary.
11. The ironic node power interface instructs the node to power on.
12. The node boots the deploy ramdisk.
13. With iSCSI deployment, the conductor copies the image over iSCSI to the physical node. With direct deployment, the deploy ramdisk downloads the image from a temporary URL. This URL must be a Swift API compatible object store or a HTTP URL.
14. The node boot interface switches PXE configuration to refer to instance images and instructs the ramdisk agent to soft power off the node. If the soft power off fails, the bare metal node is powered off with IPMI/BMC.
15. The deploy interface instructs the network interface to remove any provisioning ports, binds the tenant ports to the node, and powers the node on.

The provisioning state of the new bare metal node is now **active**.

4.5.1. Configuring the Direct Deploy Interface

The iSCSI deploy interface is the default deploy interface. However, you can enable the direct deploy interface to download an image from a HTTP location to the target disk.



NOTE

Your overcloud node memory **tmpfs** must have at least 6GB of RAM.

Procedure

1. Create or modify a custom environment file `/home/stack/undercloud_custom_env.yaml` and specify the **IronicDefaultDeployInterface**.

```
parameter_defaults:
  IronicDefaultDeployInterface: direct
```

If you register your nodes with `iscsi`, you must retain the **iscsi** value in the **IronicDefaultDeployInterface** parameter:

```
parameter_defaults:
  IronicDefaultDeployInterface: direct,iscsi
```

2. Include the custom environment file in **DEFAULT** section of the **undercloud.conf** file.

```
custom_env_files = /home/stack/undercloud_custom_env.yaml
```

3. Perform the undercloud installation:

```
$ openstack undercloud install
```

You can also specify the deploy interface when you create or update a node:

```
$ openstack baremetal node create --driver ipmi --deploy-interface direct
$ openstack baremetal node set <NODE> --deploy-interface direct
```

4.6. ADDING PHYSICAL MACHINES AS BARE METAL NODES

There are two methods to enroll a bare metal node:

1. Prepare an inventory file with the node details, import the file into the Bare Metal service, and make the nodes available.
2. Register a physical machine as a bare metal node, then manually add its hardware details and create ports for each of its Ethernet MAC addresses. These steps can be performed on any node which has your overcloudrc file.

Both methods are detailed in this section.

After enrolling the physical machines, Compute is not immediately notified of new resources, because Compute's resource tracker synchronizes periodically. Changes will be visible after the next periodic task is run. This value, **scheduler_driver_task_period**, can be updated in */etc/nova/nova.conf*. The default period is 60 seconds.

4.6.1. Enrolling a Bare Metal Node With an Inventory File

1. Create a file **overcloud-nodes.yaml**, including the node details. You can enroll multiple nodes with one file.

```
nodes:
  - name: node0
    driver: ipmi
    driver_info:
      ipmi_address: <IPMI_IP>
      ipmi_username: <USER>
      ipmi_password: <PASSWORD>
    properties:
      cpus: <CPU_COUNT>
      cpu_arch: <CPU_ARCHITECTURE>
      memory_mb: <MEMORY>
      local_gb: <ROOT_DISK>
      root_device:
        serial: <SERIAL>
    ports:
      - address: <PXE_NIC_MAC>
```

Replace the following values:

- **<IPMI_IP>** with the address of the Bare Metal controller.
- **<USER>** with your username.
- **<PASSWORD>** with your password.
- **<CPU_COUNT>** with the number of CPUs.
- **<CPU_ARCHITECTURE>** with the type of architecture of the CPUs.
- **<MEMORY>** with the amount of memory in MiB.
- **<ROOT_DISK>** with the size of the root disk in GiB.
- **<MAC_ADDRESS>** with the MAC address of the NIC used to PXE boot.
You must include **root_device** only if the machine has multiple disks. Replace **<SERIAL>** with the serial number of the disk that you want to use for deployment.

2. Configure the shell to use Identity as the administrative user:

```
$ source ~/overcloudrc
```

3. Import the inventory file into ironic:

```
$ openstack baremetal create overcloud-nodes.yaml
```

4. The nodes are now in the **enroll** state.

5. Specify the deploy kernel and deploy ramdisk on each node:

```
$ openstack baremetal node set NODE_UUID \
  --driver-info deploy_kernel=KERNEL_UUID \
  --driver-info deploy_ramdisk=INITRAMFS_UUID
```

Replace the following values:

- Replace *NODE_UUID* with the unique identifier for the node. Alternatively, use the node's logical name.
- Replace *KERNEL_UUID* with the unique identifier for the **kernel** deploy image that was uploaded to the Image service. Find this value with the following command:

```
$ openstack image show bm-deploy-kernel -f value -c id
```

- Replace *INITRAMFS_UUID* with the unique identifier for the **ramdisk** image that was uploaded to the Image service. Find this value with the following command:

```
$ openstack image show bm-deploy-ramdisk -f value -c id
```

6. Set the node's provisioning state to **available**:

```
$ openstack baremetal node manage _NODE_UUID_
$ openstack baremetal node provide _NODE_UUID_
```

The bare metal service cleans the node if you enabled node cleaning,

7. Check that the nodes were successfully enrolled:

```
$ openstack baremetal node list
```

There may be a delay between enrolling a node and its state being shown.

4.6.2. Enrolling a Bare Metal Node Manually

1. Configure the shell to use Identity as the administrative user:

```
$ source ~/overcloudrc
```

2. Add a new node:

```
$ openstack baremetal node create --driver ipmi --name NAME
```

To create a node, you must specify the driver name. This example uses **ipmi**. To use a different driver, you must enable the driver by setting the **IronicEnabledDrivers** parameter. For more information on supported drivers, see [Appendix A, Bare Metal Drivers](#).

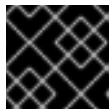

IMPORTANT

Note the unique identifier for the node.

3. Update the node driver information to allow the Bare Metal service to manage the node:

```
$ openstack baremetal node set NODE_UUID \
  --driver_info PROPERTY=VALUE \
  --driver_info PROPERTY=VALUE
```

Replace the following values:

- Replace *NODE_UUID* with the unique identifier for the node. Alternatively, use the node's logical name.
- Replace *PROPERTY* with a required property returned by the **ironic driver-properties** command.
- Replace *VALUE* with a valid value for that property.

4. Specify the deploy kernel and deploy ramdisk for the node driver:

```
$ openstack baremetal node set NODE_UUID \
  --driver-info deploy_kernel=KERNEL_UUID \
  --driver-info deploy_ramdisk=INITRAMFS_UUID
```

Replace the following values:

- Replace *NODE_UUID* with the unique identifier for the node. Alternatively, use the node's logical name.
- Replace *KERNEL_UUID* with the unique identifier for the **.kernel** image that was uploaded to the Image service.

- Replace *INITRAMFS_UUID* with the unique identifier for the *.initramfs* image that was uploaded to the Image service.
5. Update the node's properties to match the hardware specifications on the node:

```
$ openstack baremetal node set NODE_UUID \
  --property cpus=CPU \
  --property memory_mb=RAM_MB \
  --property local_gb=DISK_GB \
  --property cpu_arch=ARCH
```

Replace the following values:

- Replace *NODE_UUID* with the unique identifier for the node. Alternatively, use the node's logical name.
 - Replace *CPU* with the number of CPUs.
 - Replace *RAM_MB* with the RAM (in MB).
 - Replace *DISK_GB* with the disk size (in GB).
 - Replace *ARCH* with the architecture type.
6. OPTIONAL: Configure the node to reboot after initial deployment from a local boot loader installed on the node's disk, instead of using PXE from **ironic-conductor**. You must also set the local boot capability on the flavor used to provision the node. To enable local boot, the image used to deploy the node must contain **grub2**. Configure local boot:

```
$ openstack baremetal node set NODE_UUID \
  --property capabilities="boot_option:local"
```

Replace *NODE_UUID* with the unique identifier for the node. Alternatively, use the node's logical name.

7. Inform the Bare Metal service of the node's network card by creating a port with the MAC address of the NIC on the provisioning network:

```
$ openstack baremetal port create --node NODE_UUID MAC_ADDRESS
```

Replace *NODE_UUID* with the unique identifier for the node. Replace *MAC_ADDRESS* with the MAC address of the NIC used to PXE boot.

8. If you have multiple disks, set the root device hints. This informs the deploy ramdisk which disk it should use for deployment.

```
$ openstack baremetal node set NODE_UUID \
  --property root_device={"PROPERTY": "VALUE"}
```

Replace with the following values:

- Replace *NODE_UUID* with the unique identifier for the node. Alternatively, use the node's logical name.
- Replace *PROPERTY* and *VALUE* with details about the disk that you want to use for deployment, for example **root_device={'size': 128}**

The following properties are supported:

- **model** (String): Device identifier.
- **vendor** (String): Device vendor.
- **serial** (String): Disk serial number.
- **hctl** (String): Host:Channel:Target:Lun for SCSI.
- **size** (Integer): Size of the device in GB.
- **wwn** (String): Unique storage identifier.
- **wwn_with_extension** (String): Unique storage identifier with the vendor extension appended.
- **wwn_vendor_extension** (String): Unique vendor storage identifier.
- **rotational** (Boolean): True for a rotational device (HDD), otherwise false (SSD).
- **name** (String): The name of the device, for example: /dev/sdb1 Use this property only for devices with persistent names.



NOTE

If you specify more than one property, the device must match all of those properties.

9. Validate the configuration of the node:

```
$ openstack baremetal node validate NODE_UUID
+-----+-----+-----+
| Interface | Result | Reason |
+-----+-----+-----+
| boot      | False  | Cannot validate image information for node |
|           |        | a02178db-1550-4244-a2b7-d7035c743a9b |
|           |        | because one or more parameters are missing |
|           |        | from its instance_info. Missing are: |
|           |        | ['ramdisk', 'kernel', 'image_source'] |
| console   | None   | not supported |
| deploy    | False  | Cannot validate image information for node |
|           |        | a02178db-1550-4244-a2b7-d7035c743a9b |
|           |        | because one or more parameters are missing |
|           |        | from its instance_info. Missing are: |
|           |        | ['ramdisk', 'kernel', 'image_source'] |
| inspect   | None   | not supported |
| management | True   | |
| network   | True   | |
| power     | True   | |
| raid      | True   | |
| storage   | True   | |
+-----+-----+-----+
```

Replace *NODE_UUID* with the unique identifier for the node. Alternatively, use the node's logical name. The output of the **openstack baremetal node validate** command should report

either **True** or **None** for each interface. Interfaces marked **None** are those that you have not configured, or those that are not supported for your driver.



NOTE

Interfaces may fail validation due to missing 'ramdisk', 'kernel', and 'image_source' parameters. This result is fine, because the Compute service populates those missing parameters at the beginning of the deployment process.

4.7. USING HOST AGGREGATES TO SEPARATE PHYSICAL AND VIRTUAL MACHINE PROVISIONING

OpenStack Compute uses host aggregates to partition availability zones, and group together nodes with specific shared properties. When an instance is provisioned, Compute's scheduler compares properties on the flavor with the properties assigned to host aggregates, and ensures that the instance is provisioned in the correct aggregate and on the correct host: either on a physical machine or as a virtual machine.

Complete the steps in this section to perform the following operations:

- Add the property **baremetal** to your flavors, setting it to either **true** or **false**.
- Create separate host aggregates for bare metal hosts and compute nodes with a matching **baremetal** property. Nodes grouped into an aggregate inherit this property.

Creating a Host Aggregate

1. Set the **baremetal** property to **true** on the baremetal flavor.

```
$ openstack flavor set baremetal --property baremetal=true
```

2. Set the **baremetal** property to **false** on the flavors used for virtual instances.

```
$ openstack flavor set FLAVOR_NAME --property baremetal=false
```

3. Create a host aggregate called **baremetal-hosts**:

```
$ openstack aggregate create --property baremetal=true baremetal-hosts
```

4. Add each controller node to the **baremetal-hosts** aggregate:

```
$ openstack aggregate add host baremetal-hosts HOSTNAME
```



NOTE

If you have created a composable role with the **Novalronic** service, add all the nodes with this service to the **baremetal-hosts** aggregate. By default, only the controller nodes have the **Novalronic** service.

5. Create a host aggregate called **virtual-hosts**:

```
$ openstack aggregate create --property baremetal=false virtual-hosts
```

6. Add each compute node to the **virtual-hosts** aggregate:

```
█ $ openstack aggregate add host virtual-hosts HOSTNAME
```

7. If you did not add the following Compute filter scheduler when deploying the overcloud, add it now to the existing list under **scheduler_default_filters** in */etc/nova/nova.conf*:

```
█ AggregateInstanceExtraSpecsFilter
```

CHAPTER 5. ADMINISTERING BARE METAL NODES

This chapter describes how to provision a physical machine on an enrolled bare metal node. Instances can be launched either from the command line or from the OpenStack dashboard.

5.1. LAUNCHING AN INSTANCE USING THE COMMAND LINE INTERFACE

Use the **openstack** command line interface to deploy a bare metal instance.

Deploying an Instance on the Command Line

1. Configure the shell to access Identity as the administrative user:

```
$ source ~/overcloudrc
```

2. Deploy the instance:

```
$ openstack server create \  
  --nic net-id=NETWORK_UUID \  
  --flavor baremetal \  
  --image IMAGE_UUID \  
  INSTANCE_NAME
```

Replace the following values:

- Replace *NETWORK_UUID* with the unique identifier for the network that was created for use with the Bare Metal service.
- Replace *IMAGE_UUID* with the unique identifier for the disk image that was uploaded to the Image service.
- Replace *INSTANCE_NAME* with a name for the bare metal instance.

To assign the instance to a security group, include **--security-group SECURITY_GROUP**, replacing *SECURITY_GROUP* with the name of the security group. Repeat this option to add the instance to multiple groups. For more information on security group management, see the [Users and Identity Management Guide](#).

3. Check the status of the instance:

```
$ openstack server list --name INSTANCE_NAME
```

5.2. LAUNCH AN INSTANCE USING THE DASHBOARD

Use the dashboard graphical user interface to deploy a bare metal instance.

Deploying an Instance in the Dashboard

1. Log in to the dashboard at [http\[s\]://DASHBOARD_IP/dashboard](http[s]://DASHBOARD_IP/dashboard).
2. Click **Project > Compute > Instances**

3. Click **Launch Instance**.

- In the **Details** tab, specify the **Instance Name** and select **1** for **Count**.
- In the **Source** tab, select an **Image** from **Select Boot Source**, then click the **+** (plus) symbol to select an operating system disk image. The chosen image moves to **Allocated**.
- In the **Flavor** tab, select **baremetal**.
- In the **Networks** tab, use the **+** (plus) and **-** (minus) buttons to move required networks from **Available** to **Allocated**. Ensure that the shared network created for the Bare Metal service is selected here.
- If you want to assign the instance to a security group, in the **Security Groups** tab, use the arrow to move the group to **Allocated**.

4. Click **Launch Instance**.

5.3. CONFIGURE PORT GROUPS IN THE BARE METAL PROVISIONING SERVICE



NOTE

Port group functionality for bare metal nodes is available in this release as a **Technology Preview**, and therefore is not fully supported by Red Hat. It should be used only for testing, and should not be deployed in a production environment. For more information about Technology Preview features, see [Scope of Coverage Details](#).

Port groups (bonds) provide a method to aggregate multiple network interfaces into a single 'bonded' interface. Port group configuration always takes precedence over an individual port configuration.

If a port group has a physical network, then all the ports in that port group should have the same physical network. The Bare Metal Provisioning service supports configuration of port groups in the instances using **configdrive**.

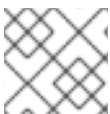

NOTE

Bare Metal Provisioning service API version 1.26 supports port group configuration.

5.3.1. Configure the Switches

To configure port groups in a Bare Metal Provisioning deployment, you must configure the port groups on the switches manually. You must ensure that the mode and properties on the switch correspond to the mode and properties on the bare metal side as the naming can vary on the switch.



NOTE

You cannot use port groups for provisioning and cleaning if you need to boot a deployment using iPXE.

Port group fallback allows all the ports in a port group to fallback to individual switch ports when a connection fails. Based on whether a switch supports port group fallback or not, you can use the `--support-standalone-ports` and --unsupport-standalone-ports` options.`

5.3.2. Configure Port Groups in the Bare Metal Provisioning Service

1. Create a port group by specifying the node to which it belongs, its name, address, mode, properties and whether it supports fallback to standalone ports.

```
# openstack baremetal port group create --node NODE_UUID --name NAME --address
MAC_ADDRESS --mode MODE --property miimon=100 --property
xmit_hash_policy="layer2+3" --support-standalone-ports
```

You can also update a port group using the **openstack baremetal port group set** command.

If you do not specify an address, the deployed instance port group address is the same as the OpenStack Networking port. The port group will not be configured if the **neutron** port is not attached.

During interface attachment, port groups have a higher priority than the ports, so they are used first. Currently, it is **not** possible to specify whether a port group or a port is desired in an interface attachment request. Port groups that do not have any ports will be ignored.



NOTE

Port groups must be configured manually in standalone mode either in the image or by generating the **configdrive** and adding it to the node's **instance_info**. Ensure that you have **cloud-init** version 0.7.7 or later for the port group configuration to work.

2. Associate a port with a port group:

- During port creation:

```
# openstack baremetal port create --node NODE_UUID --address MAC_ADDRESS --
port-group test
```

- During port update:

```
# openstack baremetal port set PORT_UUID --port-group PORT_GROUP_UUID
```

3. Boot an instance by providing an image that has **cloud-init** or supports bonding. To check if the port group has been configured properly, run the following command:

```
# cat /proc/net/bonding/bondX
```

Here, **X** is a number autogenerated by **cloud-init** for each configured port group, starting with a **0** and incremented by one for each configured port group.

5.4. DETERMINING THE HOST TO IP ADDRESS MAPPING

Use the following commands to determine which IP addresses are assigned to which host and also to which bare metal node.

This feature allows you to know the host to IP mapping from the undercloud without needing to access the hosts directly.

```
(undercloud) [stack@host01 ~]$ openstack stack output show overcloud HostsEntry --max-width 80
```

```
+-----+
| Field   | Value                                     |
+-----+
| description | The content that should be appended to your /etc/hosts if you |
|           | want to get                               |
|           | hostname-based access to the deployed nodes (useful for      |
|           | testing without                                             |
|           | setting up a DNS).                                         |
| output_key | HostsEntry                                             |
| output_value | 172.17.0.10 overcloud-controller-0.localdomain overcloud- |
|           | controller-0                                             |
|           | 10.8.145.18 overcloud-controller-0.external.localdomain    |
|           | overcloud-controller-0.external                         |
|           | 172.17.0.10 overcloud-controller-0.internalapi.localdomain |
|           | overcloud-controller-0.internalapi                       |
|           | 172.18.0.15 overcloud-controller-0.storage.localdomain    |
|           | overcloud-controller-0.storage                           |
|           | 172.21.2.12 overcloud-controller-0.storagemgmt.localdomain |
|           | overcloud-controller-0.storagemgmt                       |
|           | 172.16.0.15 overcloud-controller-0.tenant.localdomain     |
|           | overcloud-controller-0.tenant                           |
|           | 10.8.146.13 overcloud-controller-0.management.localdomain |
|           | overcloud-controller-0.management                       |
|           | 10.8.146.13 overcloud-controller-0.ctlplane.localdomain   |
|           | overcloud-controller-0.ctlplane                         |
|           |                                                           |
|           | 172.17.0.21 overcloud-compute-0.localdomain overcloud-   |
|           | compute-0                                               |
|           | 10.8.146.12 overcloud-compute-0.external.localdomain     |
|           | overcloud-compute-0.external                           |
|           | 172.17.0.21 overcloud-compute-0.internalapi.localdomain  |
|           | overcloud-compute-0.internalapi                         |
|           | 172.18.0.20 overcloud-compute-0.storage.localdomain     |
|           | overcloud-compute-0.storage                             |
|           | 10.8.146.12 overcloud-compute-0.storagemgmt.localdomain  |
|           | overcloud-compute-0.storagemgmt                         |
|           | 172.16.0.16 overcloud-compute-0.tenant.localdomain overcloud- |
|           | compute-0.tenant                                       |
|           | 10.8.146.12 overcloud-compute-0.management.localdomain  |
|           | overcloud-compute-0.management                         |
|           | 10.8.146.12 overcloud-compute-0.ctlplane.localdomain    |
|           | overcloud-compute-0.ctlplane                           |
|           |                                                           |
|           |                                                           |
|           |                                                           |
|           | 10.8.145.16 overcloud.localdomain                       |
|           | 10.8.146.7 overcloud.ctlplane.localdomain                |
|           | 172.17.0.19 overcloud.internalapi.localdomain           |
|           | 172.18.0.19 overcloud.storage.localdomain               |
|           | 172.21.2.16 overcloud.storagemgmt.localdomain           |
+-----+
```

To filter a particular host, run the following command:

```
(undercloud) [stack@host01 ~]$ openstack stack output show overcloud HostsEntry -c output_value
-f value | grep overcloud-controller-0
```

```
172.17.0.12 overcloud-controller-0.localdomain overcloud-controller-0
10.8.145.18 overcloud-controller-0.external.localdomain overcloud-controller-0.external
172.17.0.12 overcloud-controller-0.internalapi.localdomain overcloud-controller-0.internalapi
172.18.0.12 overcloud-controller-0.storage.localdomain overcloud-controller-0.storage
172.21.2.13 overcloud-controller-0.storagemgmt.localdomain overcloud-controller-0.storagemgmt
172.16.0.19 overcloud-controller-0.tenant.localdomain overcloud-controller-0.tenant
10.8.146.13 overcloud-controller-0.management.localdomain overcloud-controller-0.management
10.8.146.13 overcloud-controller-0.ctlplane.localdomain overcloud-controller-0.ctlplane
```

To map the hosts to bare metal nodes, run the following command:

```
(undercloud) [stack@host01 ~]$ openstack baremetal node list --fields uuid name instance_info -f
json
[
  {
    "UUID": "c0d2568e-1825-4d34-96ec-f08bbf0ba7ae",
    "Instance Info": {
      "root_gb": "40",
      "display_name": "overcloud-compute-0",
      "image_source": "24a33990-e65a-4235-9620-9243bcff67a2",
      "capabilities": "{\"boot_option\": \"local\"}",
      "memory_mb": "4096",
      "vcpus": "1",
      "local_gb": "557",
      "configdrive": "*****",
      "swap_mb": "0",
      "nova_host_id": "host01.lab.local"
    },
    "Name": "host2"
  },
  {
    "UUID": "8c3faec8-bc05-401c-8956-99c40cdea97d",
    "Instance Info": {
      "root_gb": "40",
      "display_name": "overcloud-controller-0",
      "image_source": "24a33990-e65a-4235-9620-9243bcff67a2",
      "capabilities": "{\"boot_option\": \"local\"}",
      "memory_mb": "4096",
      "vcpus": "1",
      "local_gb": "557",
      "configdrive": "*****",
      "swap_mb": "0",
      "nova_host_id": "host01.lab.local"
    },
    "Name": "host3"
  }
]
```

5.5. ATTACHING AND DETACHING A VIRTUAL NETWORK INTERFACE

The Bare Metal Provisioning service has an API to manage the mapping between virtual network interfaces, for example, the ones used in the OpenStack Networking service and the physical interfaces (NICs). These interfaces are configurable for each Bare Metal Provisioning node, allowing you to set the virtual network interface (VIF) to physical network interface (PIF) mapping logic using the **openstack baremetal node vif*** commands.

The following example procedure describes the steps to attach and detach VIFs.

1. List the VIF IDs currently connected to the bare metal node:

```
$ openstack baremetal node vif list baremetal-0
+-----+
| ID                |
+-----+
| 4475bc5a-6f6e-466d-bcb6-6c2dce0fba16 |
+-----+
```

2. After the VIF is attached, the Bare Metal service updates the virtual port in the OpenStack Networking service with the actual MAC address of the physical port.

This can be checked using the following command:

```
$ openstack port show 4475bc5a-6f6e-466d-bcb6-6c2dce0fba16 -c mac_address -c fixed_ips
+-----+-----+
| Field      | Value                                     |
+-----+-----+
| fixed_ips  | ip_address='192.168.24.9', subnet_id='1d11c677-5946-4733-87c3-23a9e06077aa' |
| mac_address | 00:2d:28:2f:8d:95                       |
+-----+-----+
```

3. Create a new port on the network where you have created the **baremetal-0** node:

```
$ openstack port create --network baremetal --fixed-ip ip-address=192.168.24.24 baremetal-0-extra
```

4. Remove a port from the instance:

```
$ openstack server remove port overcloud-baremetal-0 4475bc5a-6f6e-466d-bcb6-6c2dce0fba16
```

5. Check that the IP address no longer exists on the list:

```
$ openstack server list
```

6. Check if there are VIFs attached to the node:

```
$ openstack baremetal node vif list baremetal-0
$ openstack port list
```

7. Add the newly created port:

```
$ openstack server add port overcloud-baremetal-0 baremetal-0-extra
```

8. Verify that the new IP address shows the new port:

```
$ openstack server list
+-----+-----+-----+-----+-----+
-----+-----+
| ID              | Name              | Status | Networks          | Image      |
Flavor |
+-----+-----+-----+-----+-----+
-----+-----+
| 53095a64-1646-4dd1-bbf3-b51cbcc38789 | overcloud-controller-2 | ACTIVE |
ctlplane=192.168.24.7 | overcloud-full | control |
| 3a1bc89c-5d0d-44c7-a569-f2a3b4c73d65 | overcloud-controller-0 | ACTIVE |
ctlplane=192.168.24.8 | overcloud-full | control |
| 6b01531a-f55d-40e9-b3a2-6d02be0b915b | overcloud-controller-1 | ACTIVE |
ctlplane=192.168.24.16 | overcloud-full | control |
| c61cc52b-cc48-4903-a971-073c60f53091 | overcloud-novacompute-0overcloud-baremetal-
0 | ACTIVE | ctlplane=192.168.24.24 | overcloud-full | compute |
+-----+-----+-----+-----+-----+
-----+-----+
```

9. Check if the VIF ID is the UUID of the new port:

```
$ openstack baremetal node vif list baremetal-0
+-----+
| ID              |
+-----+
| 6181c089-7e33-4f1c-b8fe-2523ff431ffc |
+-----+
```

10. Check if the OpenStack Networking port MAC address is updated and matches one of the Bare Metal service ports:

```
$ openstack port show 6181c089-7e33-4f1c-b8fe-2523ff431ffc -c mac_address -c fixed_ips
+-----+-----+-----+-----+-----+
| Field  | Value                                     |
+-----+-----+-----+-----+-----+
| fixed_ips | ip_address='192.168.24.24', subnet_id='1d11c677-5946-4733-87c3-
23a9e06077aa' |
| mac_address | 00:2d:28:2f:8d:95                       |
+-----+-----+-----+-----+-----+
```

11. Reboot the bare metal node so that it recognizes the new IP address:

```
$ openstack server reboot overcloud-baremetal-0
```

After detaching or attaching interfaces, the bare metal OS removes, adds, or modifies the network interfaces that have changed. When you replace a port, a DHCP request obtains the new IP address, but this may take some time since the old DHCP lease is still valid. The simplest way to initiate these changes immediately is to reboot the bare metal host.

5.6. CONFIGURING NOTIFICATIONS FOR THE BARE METAL SERVICE

You can configure the bare metal service to display notifications for different events that occur within the service. These notifications can be used by external services for billing purposes, monitoring a data store, and so on. This section describes how to enable these notifications.

To enable notifications for the baremetal service, you must set the following options in your **ironic.conf** configuration file.

- The **notification_level** option in the **[DEFAULT]** section determines the minimum priority level for which notifications are sent. The values for this option can be set to **debug**, **info**, **warning**, **error**, or **critical**. If the option is set to **warning**, all notifications with priority level **warning**, **error**, or **critical** are sent, but not notifications with priority level **debug** or **info**. If this option is not set, no notifications are sent. The priority level of each available notification is documented below.
- The **transport_url** option in the **[oslo_messaging_notifications]** section determines the message bus used when sending notifications. If this is not set, the default transport used for RPC is used.

All notifications are emitted on the **ironic_versioned_notifications** topic in the message bus. Generally, each type of message that traverses the message bus is associated with a topic that describes the contents of the message.

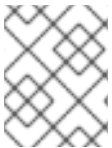

NOTE

The notifications can be lost and there is no guarantee that a notification will make it across the message bus to the end user.

5.7. CONFIGURING AUTOMATIC POWER FAULT RECOVERY

Ironic has a string field **fault** that records power, cleaning, and rescue abort failures for nodes.

Table 5.1. Ironic node faults

Fault	Description
power failure	The node is in maintenance mode due to power sync failures that exceed the maximum number of retries.
clean failure	The node is in maintenance mode due to the failure of a cleaning operation.
rescue abort failure	The node is in maintenance mode due to the failure of a cleaning operation during rescue abort.
none	There is no fault present.

Conductor checks the value of this field periodically. If the conductor detects a **power failure** state and can successfully restore power to the node, the node is removed from maintenance mode and restored to operation.

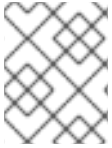
**NOTE**

If the operator places a node in maintenance mode manually, the conductor does not automatically remove the node from maintenance mode.

The default interval is 300 seconds, however, you can configure this interval with director using hieradata:

```
ironic::conductor::power_failure_recovery_interval
```

To disable automatic power fault recovery, set the value to **0**.

5.8. INTROSPECTING OVERCLOUD NODES

You can perform introspection of Overcloud nodes to monitor the specification of the nodes.

1. Source the rc file:

```
$ source ~/overcloudrc
```

2. Run the introspection command:

```
$ openstack baremetal introspection start [--wait] <NODENAME>
```

Replace <NODENAME> with the name of the node that you want to inspect.

3. Check the introspection status:

```
$ openstack baremetal introspection status <NODENAME>
```

Replace <NODENAME> with the name of the node.

CHAPTER 6. USE BARE METAL NODES AS INSTANCES

This use case allows you to deploy an instance that uses a bare metal node as the underlying hardware. Sahara performs two internal tasks when creating a big data cluster:

1. Heat is used to create the instances, including the required network.
2. When the instances are ready (**openstack server list** will be **ACTIVE**), sahara connects to each node and applies the configuration for the specified big data plugin. This can include installing additional software, spawning services, and other tasks, until the big data instance is ready.

6.1. PREREQUISITES

- Use the default parameters when deploying Bare Metal Provisioning (ironic) and Data Processing (sahara) on the overcloud.
- All the bare metal nodes must be grouped under a predefined flavor (referred to in this section as the **baremetal_flavor**).
- Mixed configurations combining virtual and bare metal nodes have not been tested, and may not be supported.

Typically, virtual instances are connected to a private project network and are accessible through a floating IP pool on a public network. However, an issue could arise if the bare metal machines managed by ironic are accessible only through a single network. As a result, the sahara cluster should be configured not to use a floating IP address pool, but to use only that network. This issue is not limited to bare metal nodes, and could also arise when sahara is used with virtual machines only.

6.2. GENERATE THE IMAGES

You may need to generate new images for the bare metal nodes using **sahara-image-elements** (including the additional **baremetal** switch). If so, you must also generate the kernel and initrd images. However, you may not need to generate the bare metal images at all, as the images typically generated by **sahara-image-elements** do work as full-disk images. The bare metal images may be needed for the **MapR** plugin, because the flavor requires an ephemeral disk and that further requires a partition image. There is currently a known issue for the generation script that prevents the creation of bare metal images. This is expected to be resolved in a future update.

Once the images are generated, you must upload the images to glance, and then register the images in sahara.

6.3. CREATE THE CLUSTER

In this example, the CDH plugin is used to demonstrate a testing scenario:

1. Create a typical set of CDH node group templates and cluster templates. However, for this use case you must specify the new **baremetal_flavor**, and you might not require a floating IP address pool. For example, you might allocate:
 - 1x manager
 - 1x master-core
 - 1x master-additional

- 1x worker-nm-dn
2. Enable **dfs_replication** by setting it to **1**.
 3. Set the flavor to **baremetal_flavor**.
 4. Create a cluster: The resulting cluster should initialize successfully, and the instances you deploy should use the bare metal nodes.

CHAPTER 7. TROUBLESHOOTING THE BARE METAL SERVICE

The following sections contain information and steps that may be useful for diagnosing issues in a setup with the Bare Metal service enabled.

7.1. PXE BOOT ERRORS

Permission Denied Errors

If you get a permission denied error on the console of your Bare Metal service node, ensure that you have applied the appropriate SELinux context to the **/httpboot** and **/tftpboot** directories as follows:

```
# semanage fcontext -a -t httpd_sys_content_t "/httpboot(/.*)?"
# restorecon -r -v /httpboot
# semanage fcontext -a -t tftpd_t "/tftpboot(/.*)?"
# restorecon -r -v /tftpboot
```

Boot Process Freezes at /pxelinux.cfg/XX-XX-XX-XX-XX-XX

On the console of your node, if it looks like you are getting an IP address and then the process stops as shown below:

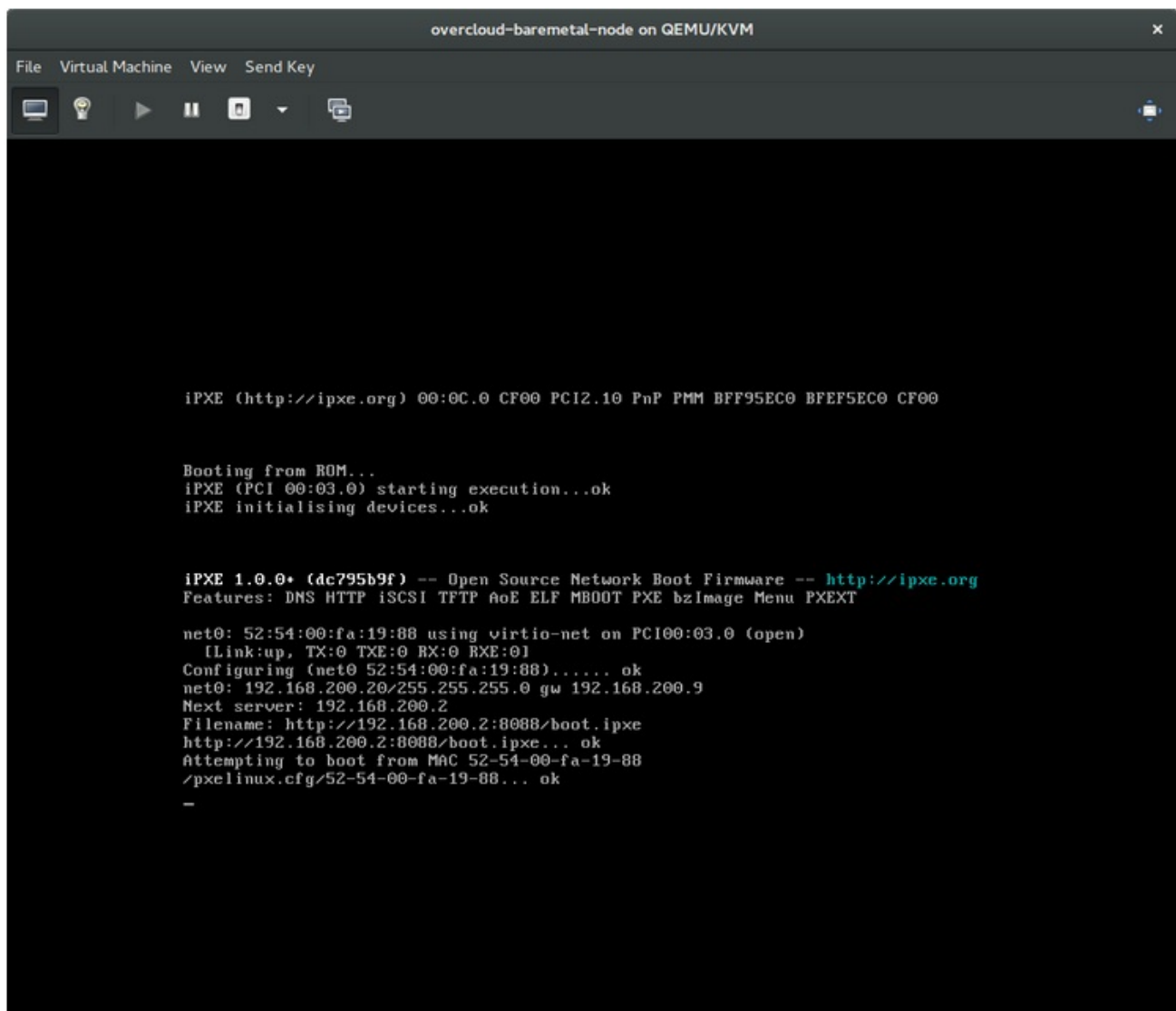

```
overcloud-baremetal-node on QEMU/KVM
File Virtual Machine View Send Key

IPXE (http://ipxe.org) 00:0C:00 CF00 PCI2.10 PnP PMM BFF95EC0 BFEF5EC0 CF00

Booting from ROM...
IPXE (PCI 00:03:0) starting execution...ok
IPXE initialising devices...ok

IPXE 1.0.0+ (dc795b9f) -- Open Source Network Boot Firmware -- http://ipxe.org
Features: DNS HTTP iSCSI TFTP AoE ELF MBOOT PXE bzImage Menu PXEXT

net0: 52:54:00:fa:19:88 using virtio-net on PCI00:03:0 (open)
[Link:up, TX:0 TXE:0 RX:0 RXE:0]
Configuring (net0 52:54:00:fa:19:88)..... ok
net0: 192.168.200.20/255.255.255.0 gw 192.168.200.9
Next server: 192.168.200.2
Filename: http://192.168.200.2:8088/boot.ipxe
http://192.168.200.2:8088/boot.ipxe... ok
Attempting to boot from MAC 52-54-00-fa-19-88
/pxelinux.cfg/52-54-00-fa-19-88... ok
-
```

This indicates that you might be using the wrong PXE boot template in your **ironic.conf** file.

```
$ grep ^pxe_config_template ironic.conf
pxe_config_template=$pybasedir/drivers/modules/ipxe_config.template
```

The default template is **pxe_config.template**, so it is easy to omit the *i* and inadvertently turn this into **ipxe_config.template**.

7.2. LOGIN ERRORS AFTER THE BARE METAL NODE BOOTS

When you try to log in at the login prompt on the console of the node with the **root** password that you set in the configurations steps, but are not able to, it indicates you are not booted in to the deployed image. You are probably stuck in the **deploy-kernel/deploy-ramdisk** image and the system has yet to get the correct image.

To fix this issue, verify the PXE Boot Configuration file in the **/httpboot/pxelinux.cfg/MAC_ADDRESS** on the Compute or Bare Metal service node and ensure that all the IP addresses listed in this file correspond to IP addresses on the Bare Metal network.



NOTE

The only network the Bare Metal service node knows about is the Bare Metal network. If one of the endpoints is not on the network, the endpoint cannot reach the Bare Metal service node as a part of the boot process.

For example, the kernel line in your file is as follows:

```
kernel http://192.168.200.2:8088/5a6cdbe3-2c90-4a90-b3c6-85b449b30512/deploy_kernel selinux=0
disk=cciss/c0d0,sda,hda,vda iscsi_target_iqn=iqn.2008-10.org.openstack:5a6cdbe3-2c90-4a90-b3c6-
85b449b30512 deployment_id=5a6cdbe3-2c90-4a90-b3c6-85b449b30512
deployment_key=VWDYDVVEFCQJNOSTO9R67HKUXUGP77CK
ironic_api_url=http://192.168.200.2:6385 troubleshoot=0 text nofb nomodeset vga=normal
boot_option=netboot ip=${ip}:${next-server}:${gateway}:${netmask} BOOTIF=${mac} ipa-api-
url=http://192.168.200.2:6385 ipa-driver-name=ipmi boot_mode=bios initrd=deploy_ramdisk
coreos.configdrive=0 || goto deploy
```

Value in the above example kernel line	Corresponding information
http://192.168.200.2:8088	Parameter http_url in /etc/ironic/ironic.conf file. This IP address must be on the Bare Metal network.
5a6cdbe3-2c90-4a90-b3c6-85b449b30512	UUID of the baremetal node in ironic node-list .
deploy_kernel	This is the deploy kernel image in the Image service that is copied down as /httpboot/<NODE_UUID>/deploy_kernel .

Value in the above example kernel line	Corresponding information
http://192.168.200.2:6385	Parameter api_url in /etc/ironic/ironic.conf file. This IP address must be on the Bare Metal network.
ipmi	The IPMI Driver in use by the Bare Metal service for this node.
deploy_ramdisk	This is the deploy ramdisk image in the Image service that is copied down as /httpboot/<NODE_UUID>/deploy_ramdisk .

If a value does not correspond between the **/httpboot/pxelinux.cfg/MAC_ADDRESS** and the **ironic.conf** file:

1. Update the value in the **ironic.conf** file
2. Restart the Bare Metal service
3. Re-deploy the Bare Metal instance

7.3. THE BARE METAL SERVICE IS NOT GETTING THE RIGHT HOSTNAME

If the Bare Metal service is not getting the right hostname, it means that **cloud-init** is failing. To fix this, connect the Bare Metal subnet to a router in the OpenStack Networking service. The requests to the meta-data agent should now be routed correctly.

7.4. INVALID OPENSTACK IDENTITY SERVICE CREDENTIALS WHEN EXECUTING BARE METAL SERVICE COMMANDS

If you are having trouble authenticating to the Identity service, check the **identity_uri** parameter in the **ironic.conf** file and ensure that you remove the **/v2.0** from the **keystone** AdminURL. For example, set the **identity_uri** to **http://IP:PORT**.

7.5. HARDWARE ENROLLMENT

Issues with enrolled hardware can be caused by incorrect node registration details. Ensure that property names and values have been entered correctly. Incorrect or mistyped property names will be successfully added to the node's details, but will be ignored.

Update a node's details. This example updates the amount of memory the node is registered to use to 2 GB:

```
$ openstack baremetal node set --property memory_mb=2048 NODE_UUID
```

7.6. NO VALID HOST ERRORS

If the Compute scheduler cannot find a suitable Bare Metal node on which to boot an instance, a

NoValidHost error can be seen in `/var/log/nova/nova-conductor.log` or immediately upon launch failure in the dashboard. This is usually caused by a mismatch between the resources Compute expects and the resources the Bare Metal node provides.

1. Check the hypervisor resources that are available:

```
$ openstack hypervisor stats show
```

The resources reported here should match the resources that the Bare Metal nodes provide.

2. Check that Compute recognizes the Bare Metal nodes as hypervisors:

```
$ openstack hypervisor list
```

The nodes, identified by UUID, should appear in the list.

3. Check the details for a Bare Metal node:

```
$ openstack baremetal node list
$ openstack baremetal node show NODE_UUID
```

Verify that the node's details match those reported by Compute.

4. Check that the selected flavor does not exceed the available resources of the Bare Metal nodes:

```
$ openstack flavor show FLAVOR_NAME
```

5. Check the output of **openstack baremetal node list** to ensure that Bare Metal nodes are not in maintenance mode. Remove maintenance mode if necessary:

```
$ openstack baremetal node maintenance unset NODE_UUID
```

6. Check the output of **openstack baremetal node list** to ensure that Bare Metal nodes are in an **available** state. Move the node to **available** if necessary:

```
$ openstack baremetal node provide NODE_UUID
```

APPENDIX A. BARE METAL DRIVERS

A bare metal node can be configured to use one of the drivers enabled in the Bare Metal service. Each driver is made up of a provisioning method and a power management type. Some drivers require additional configuration. Each driver described in this section uses PXE for provisioning; drivers are listed by their power management type.

You can add drivers with the **IronicEnabledHardwareTypes** parameter in your **ironic.yaml** file. By default, **ipmi**, **redfish**, **idrac** and **ilo** are enabled.

For the full list of supported plug-ins and drivers, see [Component, Plug-In, and Driver Support in Red Hat OpenStack Platform](#).

A.1. INTELLIGENT PLATFORM MANAGEMENT INTERFACE (IPMI)

IPMI is an interface that provides out-of-band remote management features, including power management and server monitoring. To use this power management type, all Bare Metal service nodes require an IPMI that is connected to the shared Bare Metal network. Enable the **ipmi** driver, and set the following information in the node's **driver_info**:

- **ipmi_address** - The IP address of the IPMI NIC.
- **ipmi_username** - The IPMI user name.
- **ipmi_password** - The IPMI password.

A.2. REDFISH

A standard RESTful API for IT infrastructure developed by the Distributed Management Task Force (DMTF)

- **redfish_username** - The Redfish username.
- **redfish_password** - The Redfish password.
- **redfish_address** - The IP address of the Redfish controller.
- **redfish_system_id** - The canonical path to the system resource. This path should include the root service, version, and the path/unique ID for the system. For example: **/redfish/v1/Systems/CX34R87**.
- **redfish_verify_ca** - Either a Boolean value, a path to a CA_BUNDLE file, or a directory with certificates of trusted CAs. If set to **True** the driver verifies the host certificates. If **False** the driver ignores verifying the SSL certificate. If set to a path, the driver uses the specified certificate or one of the certificates in the directory. Defaults to **True**.

A.3. DELL REMOTE ACCESS CONTROLLER (DRAC)

DRAC is an interface that provides out-of-band remote management features, including power management and server monitoring. To use this power management type, all Bare Metal service nodes require a DRAC that is connected to the shared Bare Metal network. Enable the **idrac** driver, and set the following information in the node's **driver_info**:

- **drac_address** - The IP address of the DRAC NIC.

- **drac_username** - The DRAC user name.
- **drac_password** - The DRAC password.

A.4. INTEGRATED REMOTE MANAGEMENT CONTROLLER (iRMC)

iRMC from Fujitsu is an interface that provides out-of-band remote management features including power management and server monitoring. To use this power management type on a Bare Metal service node, the node requires an iRMC interface that is connected to the shared Bare Metal network. Enable the **irmc** driver, and set the following information in the node's **driver_info**:

- **irmc_address** - The IP address of the iRMC interface NIC.
- **irmc_username** - The iRMC user name.
- **irmc_password** - The iRMC password.

To use IPMI to set the boot mode or SCCI to get sensor data, you must complete the following additional steps:

1. Enable the sensor method in *ironic.conf*:

```
$ openstack-config --set /etc/ironic/ironic.conf \
  irmc sensor_method METHOD
```

Replace *METHOD* with **scci** or **ipmitool**.

2. If you enabled SCCI, install the **python-scciclient** package:

```
# yum install python-scciclient
```

3. Restart the Bare Metal conductor service:

```
# systemctl restart openstack-ironic-conductor.service
```



NOTE

To use the iRMC driver, iRMC S4 or higher is required.

A.5. INTEGRATED LIGHTS-OUT (iLO)

iLO from Hewlett-Packard is an interface that provides out-of-band remote management features including power management and server monitoring. To use this power management type, all Bare Metal nodes require an iLO interface that is connected to the shared Bare Metal network. Enable the **ilo** driver, and set the following information in the node's **driver_info**:

- **ilo_address** - The IP address of the iLO interface NIC.
- **ilo_username** - The iLO user name.
- **ilo_password** - The iLO password.

You must also install the **python-proliantutils** package and restart the Bare Metal conductor service:

```
# yum install python-proliantutils
# systemctl restart openstack-ironic-conductor.service
```

A.6. CONVERTING TO NEXT GENERATION POWER MANAGEMENT DRIVERS

Red Hat OpenStack Platform now uses next generation drivers, also known as *hardware types*, that replace older drivers.

The following table shows an analogous comparison between older drivers and their next generation hardware type equivalent:

Old Driver	New Hardware Type
pxe_ipmitool	ipmi
pxe_drac	idrac
pxe_ilo	ilo
pxe_ucs	cisco-ucs-managed
pxe_irmc	irmc
fake_pxe	fake-hardware

In OpenStack Platform 15, these older drivers have been removed and are no longer accessible. You must change to hardware types **before** upgrading to OpenStack Platform 15.

Procedure

1. Check the current list of hardware types enabled:

```
$ source ~/overcloud
$ openstack baremetal driver list --type dynamic
```

2. If you use a hardware type driver that is not enabled, enable the driver using the **IronicEnabledHardwareTypes** parameter in an environment file:

```
parameter_defaults:
  IronicEnabledHardwareTypes: ipmi,redfish,idrac
```

3. Save the file and run your overcloud deployment command:

```
$ openstack overcloud deploy -e [ENVIRONMENT_FILE] -r [ROLES_DATA] -n
[NETWORK_DATA]
```

Ensure that you include all environment and data files relevant to your overcloud.

4. Run the following commands, substituting the **OLDDRIVER** and **NEWDRIVER** variables for your power management type:

```
$ source ~/overcloud
$ OLDDRIVER="pxe_ipmitool"
$ NEWDRIVER="ipmi"
$ for NODE in $(openstack baremetal node list --driver $OLDDRIVER -c UUID -f value) ; do
openstack baremetal node set $NODE --driver $NEWDRIVER; done
```