



# **Red Hat CloudForms 4.0**

## **Scripting Actions in CloudForms**

Real-time, bi-directional process integration for CloudForms Management Engine



# Red Hat CloudForms 4.0 Scripting Actions in CloudForms

---

Real-time, bi-directional process integration for CloudForms Management Engine

Red Hat CloudForms Documentation Team

[cloudforms-docs@redhat.com](mailto:cloudforms-docs@redhat.com)

## Legal Notice

Copyright © 2017 Red Hat, Inc.

The text of and illustrations in this document are licensed by Red Hat under a Creative Commons Attribution-Share Alike 3.0 Unported license ("CC-BY-SA"). An explanation of CC-BY-SA is available at

<http://creativecommons.org/licenses/by-sa/3.0/>

. In accordance with CC-BY-SA, if you distribute this document or an adaptation of it, you must provide the URL for the original version.

Red Hat, as the licensor of this document, waives the right to enforce, and agrees not to assert, Section 4d of CC-BY-SA to the fullest extent permitted by applicable law.

Red Hat, Red Hat Enterprise Linux, the Shadowman logo, JBoss, OpenShift, Fedora, the Infinity logo, and RHCE are trademarks of Red Hat, Inc., registered in the United States and other countries.

Linux ® is the registered trademark of Linus Torvalds in the United States and other countries.

Java ® is a registered trademark of Oracle and/or its affiliates.

XFS ® is a trademark of Silicon Graphics International Corp. or its subsidiaries in the United States and/or other countries.

MySQL ® is a registered trademark of MySQL AB in the United States, the European Union and other countries.

Node.js ® is an official trademark of Joyent. Red Hat Software Collections is not formally related to or endorsed by the official Joyent Node.js open source or commercial project.

The OpenStack ® Word Mark and OpenStack logo are either registered trademarks/service marks or trademarks/service marks of the OpenStack Foundation, in the United States and other countries and are used with the OpenStack Foundation's permission. We are not affiliated with, endorsed or sponsored by the OpenStack Foundation, or the OpenStack community.

All other trademarks are the property of their respective owners.

## Abstract

This guide provides instructions for scripting the method to implement adaptive automation for management events and administrative or operational activities. If you have a suggestion for improving this guide or have found an error, please submit a Bugzilla report at <http://bugzilla.redhat.com> against Red Hat CloudForms Management Engine for the Documentation component. Please provide specific details, such as the section number, guide name, and CloudForms version so we can easily locate the content.

## Table of Contents

<b>CHAPTER 1. CLOUDFORMS MANAGEMENT ENGINE AUTOMATION</b> .....	<b>4</b>
1.1. AUTOMATION	4
<b>CHAPTER 2. AUTOMATE MODEL</b> .....	<b>5</b>
2.1. AUTOMATE MODEL	5
2.2. CREATING A DOMAIN	6
2.3. EDITING A DOMAIN	6
2.4. DELETING A DOMAIN	6
2.5. CHANGING PRIORITY ORDER OF DOMAINS	7
2.6. CREATING A NAMESPACE	7
2.7. CREATING A CLASS	7
2.8. CREATING A SCHEMA FOR A CLASS	8
2.9. EDITING A FIELD IN A SCHEMA	9
2.10. EDITING SCHEMA SEQUENCE	9
2.11. ADDING AN INSTANCE TO A CLASS	9
2.12. COPYING A CLASS OR INSTANCE	10
2.13. RELATIONSHIPS	10
2.14. METHODS	11
2.14.1. Creating a Method	11
2.14.2. Creating a Dynamic Content Dialog	12
2.15. SIMULATION	13
2.15.1. Simulation	13
2.15.2. Simulating an Automate Model	13
2.16. IMPORTING, EXPORTING, AND RESETTING THE DATASTORE	14
2.16.1. Importing, Exporting, and Resetting the Datastore	14
2.16.2. Exporting All Datastore Classes	14
2.16.3. Importing Datastore Classes	14
2.16.4. Resetting Datastore to Default	15
<b>CHAPTER 3. INVOKING AUTOMATE</b> .....	<b>16</b>
3.1. AUTOMATE EXAMPLES	16
3.2. INVOKING AUTOMATE USING A CUSTOM BUTTON	16
3.3. CREATING A CUSTOM BUTTON GROUP	16
3.4. CREATING A CUSTOM BUTTON	16
3.5. EDITING A CUSTOM BUTTON	17
3.6. DELETING A CUSTOM BUTTON	18
3.7. USING A CUSTOM BUTTON	18
3.8. INITIATING AUTOMATE FROM AN EVENT	18
3.9. CREATING A POLICY FOR AUTOMATE	19
3.10. CREATING A CUSTOM AUTOMATE ACTION	20
<b>APPENDIX A. OBJECTS</b> .....	<b>21</b>
A.1. VIRTUAL MACHINE PROPERTIES	21
A.2. CLOUDFORMS MANAGEMENT ENGINE METHODS FOR USE IN RUBY SCRIPTS	25
A.3. HOST PROPERTIES	26
A.4. PROVIDER PROPERTIES	29
A.5. STORAGE PROPERTIES	31
<b>APPENDIX B. FAQs AND FLOWS</b> .....	<b>33</b>
B.1. PHASE 1: CREATE PROVISION REQUEST	33
B.2. PHASE 2: REQUEST APPROVAL	34
B.3. PHASE 3: QUOTA VALIDATION	35

B.4. PHASE 4: PROVISIONING	35
B.5. PHASE 5: RETIREMENT	36
<b>APPENDIX C. INLINE METHOD TO CREATE A PROVISION REQUEST .....</b>	<b>38</b>
C.1. RUBY METHOD	38



# CHAPTER 1. CLOUDFORMS MANAGEMENT ENGINE AUTOMATION

Provisioning requires the **Automation Engine** server role enabled. Check your server role settings in **Configure** → **Configuration** → **Server** → **Server Control**.

## 1.1. AUTOMATION

CloudForms Management Engine Automate Model provides flexibility to not only change parts of the provisioning process, but also to allow you to automate other operational tasks. Below are some scenarios where CloudForms Management Engine can help accomplish these tasks.

- **Intelligent Workload Management** - An enterprise had a requirement that when a virtual machine has reached a High CPU Percent Ready for a specified period of time, a vMotion should occur to a more suitable host. For this reason, VMware's Distributed Resource Scheduler (DRS) was not practical, as the CPU Ready metric could not trigger DRS. The solution was to leverage CloudForms Management Engine Control and CloudForms Management Engine Automate to drive the management of this workflow.
- **Power on only during business hours** - An organization which gave a group of self-service users CloudForms Management Engine access had a requirement to only allow certain virtual machines to be powered during business hours. This was solved with CloudForms Management Engine Automate.
- **Auto-Tagging virtual machines based on file contents** - An IT organization needed a way to consume information from a text file on a virtual machine and dynamically populate vCenter. The data used to auto-tag virtual machines is also used to align unmanaged virtual machines to the business.



## CHAPTER 2. AUTOMATE MODEL

CloudForms Management Engine Automate enables real-time, bi-directional process integration. This provides users with a method to implement adaptive automation for management events and administrative or operational activities.

### 2.1. AUTOMATE MODEL

The Automate model is arranged to provide an object oriented hierarchy to control automation functions. The model uses the following organizational units arranged in a hierarchy:

- **Datastore** - The main organization unit that stores the entire model.
- **Domains** - Domains act as collection of automation functions. Functions are executed depending on the order of Domain priority, which means a function in a Domain with a higher priority overrides the same functions specified in a lower-priority Domain. This allows CloudForms Management Engine to specify a core Domain (ManagelQ) but allow users to override automate functions with custom Domains. Each Domain contains a set of Namespaces.
- **Namespaces** - Containers that organize and categorize functions of the model. Namespaces can contain child Namespaces as well as Classes.
- **Classes** - Templates for a specific function of the model. Each Class uses a Schema to apply to Instances to populate with default values. Each class also can contain a set of methods.
- **Instances** - An instance is a version of a class populated with initial configuration data. An instance can include a collection of any number of attributes, calls to methods, and relationships.
- **Methods** - Methods are functions within the model. Methods use Ruby code to execute various operations needed for a Class.

CloudForms Management Engine contains a set of preconfigured Domains for users:

- **ManagelQ** - The core domain for CloudForms Management Engine Automate operations. This domain is locked with the following Namespaces:
  - **Cloud** - General cloud instance lifecycle from provisioning, retirement, methods, email.
  - **Control** - Control contains email alerts for policy controls.
  - **Infrastructure** - General infrastructure VM lifecycle from provisioning, retirement, methods, email.
  - **Service** - Service lifecycle from provisioning, retirement, methods, email.
  - **System** - System contains classes that can provide the start points for all CloudForms Management Engine Automate activities.
- **RedHat** - Domain containing advanced operations, specifically interactions with supported cloud and infrastructure providers. This domain is locked with the following Namespaces:
  - **Cloud** - Red Hat-supported cloud instance lifecycle from provisioning, retirement, methods, email.

- Infrastructure - Red Hat-supported cloud instance lifecycle from provisioning, retirement, methods, email.
- Integration - Used to interface with systems outside of CloudForms Management Engine. Use this namespace to integrate with additional systems.

You can copy classes and instances from locked Domains into your own custom domains.





#### NOTE

Red Hat does not recommend changing any of the existing classes or instances shipped with the product as this may hinder the operation of the CloudForms Management Engine. You can link to these methods using relationships.



To reset the Automate model to default settings, navigate to **Automate** → **Import/Export** and click the **Reset** option.

## 2.2. CREATING A DOMAIN

1. Navigate to **Automate** → **Explorer**. The default view is the Datastore.
2. Click  (**Configuration**), then  (**Add a New Domain**).
3. Type in a unique **Name** and **Description**. Choose if the Domain is **Enabled**.
4. Click **Add**.



The new domain is created.

## 2.3. EDITING A DOMAIN

1. Navigate to **Automate** → **Explorer**. The default view is the Datastore.
2. Select the Domain you want to edit.
3. Click  (**Configuration**), then  (**Edit Selected Domain**).
4. Make the required edits.
5. Click **Save**.

You have edited the selected domain.

## 2.4. DELETING A DOMAIN



1. Navigate to **Automate** → **Explorer**. The default view is the Datastore.
2. Select the **Domain** that you want to delete.
3. Click  (**Configuration**), then  (**Remove This Domain**).
4. A window to confirm the removal of Domain appears.

5. Click **OK**.



The selected Domain is deleted.

## 2.5. CHANGING PRIORITY ORDER OF DOMAINS

Functions are executed depending on the order of Domain priority. Use this procedure to change the priority order of domains.



1. Navigate to **Automate** → **Explorer**. The default view is the Datastore.
2. Select the Domains you want to change the priority order for.
3. Click  (**Configuration**), then  (**Edit Priority Order of Domains**).
4. The list of Domains selected shows up. Note that you cannot change the priority of locked Domains and therefore locked Domains do not show up on the list.
5. Select one or more consecutive groups to move up or down to change their priority as required.
6. Click **Save**.

## 2.6. CREATING A NAMESPACE

1. Navigate to **Automate** → **Explorer**. The default view is the Datastore.
2. Navigate through the various Domains and Namespaces until you reach the desired location for your new Namespace.
3. Click  (**Configuration**), then  (**Add a New Namespace**).
4. Type in a unique **Name** and **Description**.
5. Click **Add**.

The new Namespace is created.

## 2.7. CREATING A CLASS

1. Navigate to **Automate** → **Explorer**, navigate to the namespace you want to add a class to.
2. Click  (**Configuration**), then  (**Add a new Class**).
3. Type in a unique **Name** and **Description**.
4. If you want to use the schema from a class that has already been created, select it from the **Inherits From** dropdown. If the class that the new class inherits from changes, the new class will also change.
5. Click **Add**.





The new class is created and you can create a schema, add instances and methods.

**NOTE**

For each class, create a schema if you did not choose to inherit from an existing class. The schema can include attributes, methods, assertions, and relationships.

## 2.8. CREATING A SCHEMA FOR A CLASS

This procedure shows you how to create a schema.

1. Navigate to **Automate** → **Explorer**, and click the class you want to define a schema for.
2. Click on the **Schema** tab.
3. Click  (**Configuration**), then  (**Edit selected Schema**).
4. Click  (**Click to add a new field**) to create a new field.
5. Type in a **Name** for the new field.
6. From **Type**, select **Assertion**, **Attribute**, **Method**, **Relationship**, or **State**.
7. If applicable, select a **Data Type** and set a **Default Value**.
8. Type in a user friendly **Display Name** and **Description**.
9. Check **Sub** to enable the substitution syntax of `${}`. Uncheck it if you want to use that syntax as a regular string.
10. Fill in **Collect** and **Message** as required. **Collect** is used to roll up values from resolved relationships. For example, a relationship can resolve to a large object tree. Use **collect** to specify how to pull out data from those child objects into the current object. If you give **collect** a name value, it will store the method result in an attribute of the current object with that name.
11. **On Entry**, **On Exit**, **On Error**, **Max Retries**, and **Max Time** are fields used mostly for state machines. Leave blank if not applicable. For more information, see the *Provisioning Virtual Machines and Hosts* guide, available from <https://access.redhat.com/documentation/en/red-hat-cloudforms/>.
12. Click  (**Add this entry**) to confirm the fields values.
13. For each new field, repeat steps 4 through 10.
14. When you have created all of the fields, click **Save**.



The class schema is created, and you can now add instances to it.

**NOTE**

You may need to edit a class schema to reorder, add, edit, or remove a field. Classes define the order in which fields are processed and you may need to process some items before others.

## 2.9. EDITING A FIELD IN A SCHEMA





This procedure describes how to edit schema fields.

1. Navigate to **Automate** → **Explorer**.
2. Click the class you want to define a schema for.
3. Click the **Schema** tab.
4. Click  (**Configuration**), then  (**Edit selected Schema**).
5. Make required changes to any of the definitions for the field.
6. To remove a field, click  (**Click to delete this field from the schema**).
7. Click **Save** when you are finished editing the schema.

Once the schema is created, you can add instances and methods to the class.

## 2.10. EDITING SCHEMA SEQUENCE

This procedure shows you how to change schema sequence.

1. Navigate to **Automate** → **Explorer**.
2. Click the class you want to change the schema sequence for.
3. Click the **Schema** tab.
4. Click  (**Configuration**), then  (**Edit Sequence**).
5. In the **Class Schema Sequencing** area, click the field you want to change the sequence for.
  - To move a field up in the order of resolving an instance, click  (**Move selected field up**).
  - To move a field down in the order of resolving an instance, click  (**Move selected field down**).
6. Click **Save** when you are finished editing the sequence.

## 2.11. ADDING AN INSTANCE TO A CLASS

This procedure shows you how to create an instance.

1. Navigate to **Automate** → **Explorer**.
2. Click the class you want to define a schema for.

3. Click the **Instances** tab.
4. Click  (**Configuration**), then  (**Add a new Instance**).
5. In the **Main Info** area, type in a **Name**, **Display Name** and **Description**.
6. In the **Fields** area, type in an appropriate value for each field, leave the field blank if no value is required, or use the default value.
7. Click **Add**.

## 2.12. COPYING A CLASS OR INSTANCE

1. Navigate to **Automate** → **Explorer**. The default view is the **Datastore**.
2. Navigate through the various **Domains** and **Namespaces** until you reach the desired class or instance to copy.
3. Click  (**Configuration**), then either (**Copy this Class**) or (**Copy this Instance**) depending on the object chosen.
4. Choose the target **Domain** in the **To Domain** drop-down menu.
5. The object retains the same path as the **From Domain** and overrides the class in **From Domain** if the **To Domain** has a high priority. You can also untick the **Copy to same path** option to specify a new **Namespace**.
6. Click **Add**.

## 2.13. RELATIONSHIPS

Relationships are used to connect to other instances in the **Automation Datastore**. Relationships are formed using URI syntax. The following can also be passed through a relationship:

- Use **#** to set the message to send to the item in the relationship.
- To pass an input to the method use **?** followed by the item to pass.
- If you want to use a substitution, the syntax is **\{\}** with the substitution located between the brackets.

Example	Explanation
/Cloud/VM/Provisioning/Naming/Default#create	This relationship uses the Default instance of the Naming class, which provides a means for other classes to name virtual machines. The relationship sends the <b>create</b> message to the class.

Example	Explanation
<code>/Cloud/VM/Provisioning/StateMachines/VMProvision_VM/AcquireMACAddress#\$\{#ae_message}</code>	This relationship substitutes the message to send to the <code>AcquireMACAddress</code> instance of the <code>VMProvision_VM</code> class with the value in <code>ae_message</code> .
<code>/Cloud/VM/Retirement/Email/vm_retirement_emails?event=vm_retired</code>	Invokes the <code>vm_retirement_emails</code> instance of the <code>Email</code> class. Also sends the value <code>vm_retired</code> in the <code>event</code> attribute, which is used in the <code>vm_retirement_emails</code> method.
<code>/Service/Lifecycle/Retirement?service_id=\$\{process#service_id}</code>	Invokes the <code>Retirement</code> instance of the <code>Lifecycle</code> class and send a replacement value in <code>process#service_id</code> to the <code>service_id</code> attribute.

## 2.14. METHODS

Methods are pieces of code associated with a class or object to perform a task. CloudForms Management Engine allows for Ruby methods. You can create your own methods or use relationships to link to pre-existing ones.

Red Hat CloudForms ships with a core set of Ruby gems used by the CloudForms Management Engine Rails Application. The Ruby gems in this set are subject to change, and have changed since CloudForms 3.1 (CloudForms Management Engine 5.3). If you are calling gems using Automate that are no longer in the CloudForms Management Engine Appliance, you can install them by using the `gem install` command.

While gems can be imported into automation methods using `require`, it is recommended that the authors of the automation methods clearly document the use of gems either in the core set or a custom set. It is the responsibility of the author of such custom automation to own the life cycle of any gem being referenced in those methods.



The Release Notes list Ruby gems that have been added, updated, or removed in the latest version of CloudForms Management Engine.

For lists of Ruby gems included in different CloudForms Management Engine releases, see the following article:

- <https://access.redhat.com/articles/1534753>

### 2.14.1. Creating a Method

This procedure shows you how to create a method.

1. Navigate to **Automate** → **Explorer**, navigate to the class where you want to create a method.
2. Click the **Methods** tab.
3. Click  (**Configuration**),  (**Add a New Method**).

4. In the **Main Info** area, type in a **Name** and **Display Name**.
5. For **Location**, select **inline**. Once selected, you will be presented with a **Data** area in which to write or copy the script.
6. Click **Validate** to check the syntax.
7. Click **Add**.

### 2.14.2. Creating a Dynamic Content Dialog

The procedure describes the steps to create a dynamic content dialog.



1. Navigate to **Automate** → **Explorer**.
2. From the accordion menu, click **DOMAIN** → **Cloud** → **VM** → **Operations** → **Methods**.



#### NOTE

DOMAIN must be a user-defined Domain and not the locked ManageIQ Domain. If necessary, you can copy the class from the ManageIQ domain into a custom domain.

This example uses the **Cloud** Namespace but can also use the **Infrastructure** namespace.

3. Click  (**Configuration**), then  (**Add a new Instance**).
4. In the **Main Info** area, enter **Name** = *dynamic\_list*, replacing *dynamic\_list* with an appropriate name for the method.
5. Enter a **Display Name** and **Description**.
6. In the **Fields** area, enter **Value** = *dynamic\_list*. Leave the other fields blank or use the default values.
7. Click **Add**.
8. Navigate to **Methods** tab.
9. In the **Main Info** area, enter **Name** = `\\dynamic_list` and populate the **Data** section with the example automate method below.
10. Click **Add**.
11. Set the automate entry point for the dialog control; use the new instance created in step four. You can create a new domain and copy the method to that domain.

```
# Automate Method

dialog_field = $evm.object

# sort_by: value / description / none
dialog_field["sort_by"] = "value"
```



```

# sort_order: ascending / descending
#dialog_field["sort_order"] = "ascending"

# data_type: string / integer
dialog_field["data_type"] = "integer"

# required: true / false
# dialog_field["required"] = "true"

dialog_field["values"] = {1 => "one", 2 => "two", 10 => "ten", 50 =>
"fifty"}
dialog_field["default_value"] = 2

```

## 2.15. SIMULATION

### 2.15.1. Simulation

After your model is designed, use the simulate page to test it. It allows you to see the results in tree and XML view.

### 2.15.2. Simulating an Automate Model

This procedure shows you how to simulate an automate model.

1. Navigate to **Automate** → **Simulation**.
2. In **Object Details**, select a type of object from **/System/Process/** that will initiate the model. The **Message** should be **create**. Type in the name of the **Request** where you are starting from.

Object Details	
<b>/System/Process/</b>	Event
<b>Message</b>	create
<b>Request</b>	vm_create

3. Select the **Type** of item you want to run the simulation on. Then, select a specific one to use as the example.

The screenshot shows a form titled "Object Attribute". It contains a "Type" dropdown menu. The dropdown is currently set to "<None>" and is open, showing a list of options: "<None>", "Cluster", "Datastore", "Host", "Provider", "Service", "Service Catalog Item", "VM Template and Image", and "VM and Instance".

4. Check **Execute Methods** if you want to perform the model and not just simulate it.

The screenshot shows a form titled "Simulation Parameters". It contains a checkbox labeled "Execute Methods" which is currently unchecked.

5. Type in the **Attribute/Value Pairs** fields if applicable.
6. Click **Submit**.

Click on the **Tree View** or **XML View** tabs to see results.

## 2.16. IMPORTING, EXPORTING, AND RESETTING THE DATASTORE

### 2.16.1. Importing, Exporting, and Resetting the Datastore

The **Automate Model** can be exported and imported as a YAML file. CloudForms Management Engine allows you to back up your model by export. Red Hat may provide you with new or updated classes, and provides an import function for either a class or the entire model. Finally, you can reset the datastore to its default. Always be sure to export the current datastore before importing or resetting.

### 2.16.2. Exporting All Datastore Classes

This procedure shows you how export datastore classes as an XML file.

1. Navigate to **Automate** → **Import/Export**.
2. Click  (**Export all Datastore classes and instances to a file**).
3. Follow your browser's prompts to save the file.

The datastore is exported as a YAML file.

### 2.16.3. Importing Datastore Classes

This procedure shows you how to import datastore classes.

1. Navigate to **Automate** → **Import/Export**.
2. Export the datastore so that you have a backup.
3. Click **Browse** to navigate to the location of the file to import.
4. Click **Upload**.

The datastore is imported from the YAML file.

#### 2.16.4. Resetting Datastore to Default

This procedure shows you how reset datastore to default.

1. Navigate to **Automate** → **Import/Export**.
2. Export the datastore so that you have a backup.
3. Click  (**Reset all Datastore custom classes and instances to default**).
4. Read the prompt warning you that communication with the datastore will be lost and all classes and instances will be cleared and reset.
5. After reading the prompt, click **OK**.

## CHAPTER 3. INVOKING AUTOMATE

### 3.1. AUTOMATE EXAMPLES

This chapter describes the ways to invoke an Automate workflow. Automation can be initiated through an alert, an event, a CloudForms Management Engine application, or a custom button. The same automation process can be re-used across more than one of these. For example, using automation to remove orphaned virtual machines and instances could be initiated by:

- An administrator request from the CloudForms Management Engine console (from a custom button)
- An alert indicating the datastore has less than 20% free-space
- A virtual machine or instance unregistered event is detected

All invocations of an automate model must enter through the `/System/Process` namespace.



### 3.2. INVOKING AUTOMATE USING A CUSTOM BUTTON

One of the ways to invoke an Automate model is to map an instance from the `/System/Process/Request` class to a custom button. Before creating the button, you need to have an instance in the `/System/Process/Request` class to map to it and a button group to assign it to.

Create buttons for a cluster, host, datastore, provider, virtual machines or cloud instances. When the button is clicked, the model will be invoked for the selected item. For each of these, you can have up to 15 buttons.

### 3.3. CREATING A CUSTOM BUTTON GROUP



This procedure shows you how to create a custom button group.

1. Navigate to **Automate** → **Customization**.
2. Click the **Buttons** accordion.
3. From the **Object Types** tree, select the type of object you want to create the button group for.
4. Click  (**Configuration**),  (**Add a new Button Group**).
5. Type in a **Button Group Text** and **Button Group Hover Text**, and select the **Button Group Image** you want to use.
6. If custom buttons have already been created, assign them to the button group. If not, see [Section 3.4, “Creating a Custom Button”](#) to create custom buttons.
7. Click **Add**.

The button group will show in the object type you added the button to.

### 3.4. CREATING A CUSTOM BUTTON

This procedure shows you how to create a custom button.

1. Navigate to **Automate** → **Customization**.
2. Click the **Buttons** accordion.
3. From the **Object Types** tree, select the type of object you want to create the button for.
4. Click **Unassigned Buttons**.
5. Click  (**Configuration**), then  (**Add a new Button**).



#### NOTE



If  (**Add a new Button**) is not available, that means you have not created a button group for that object. To continue, create a button group first. See [Section 3.3, “Creating a Custom Button Group”](#)

6. In **Action**, type in a **Button Text** and **Button Hover Text**, and select the **Button Image** you want to use.
7. Select a **Dialog** if applicable.
8. In **Object Details**, select **Request** from the **/System/Process/** dropdown. By default, the message is **create**. Do not change it.
9. Type in a **Request** name for the **/System/Process/Request** instance.
10. Type in the **Attribute/Value Pairs** fields if applicable.
11. Under **Visibility**, select which **Account Roles** you want to have access to this button.
12. Click **Add** when you have confirmed that the button accomplishes the task you want.

The button will show in the object type you added the button to.



## 3.5. EDITING A CUSTOM BUTTON

This procedure shows you how to edit a custom button.

1. Navigate to **Automate** → **Customization**.
2. From the **Object Types** dropdown, select the type of object you want to edit the button for.
3. Click the button you want to edit.
4. Click  (**Configuration**),  (**Edit this Button**).
5. Modify as required.
6. Click **Save**.

### 3.6. DELETING A CUSTOM BUTTON

This procedure shows you how to delete a custom button.

1. Navigate to **Automate** → **Customization**, then select the **Buttons** accordion.
2. From the **Object Type** tree in the accordion menu, select the type of object you want to remove the button from.
3. Click  (**Configuration**), then click  (**Remove this button**).
4. Click **OK** to confirm that you want to delete this button.

### 3.7. USING A CUSTOM BUTTON

This procedure shows you how to use custom buttons to invoke a cluster, host, datastore, provider, virtual machine or instance.

1. Go to the page for the item that you created a button for.
2. Click the custom button group from the taskbar, and then your custom button.

The automate model is invoked for the specified item.

### 3.8. INITIATING AUTOMATE FROM AN EVENT



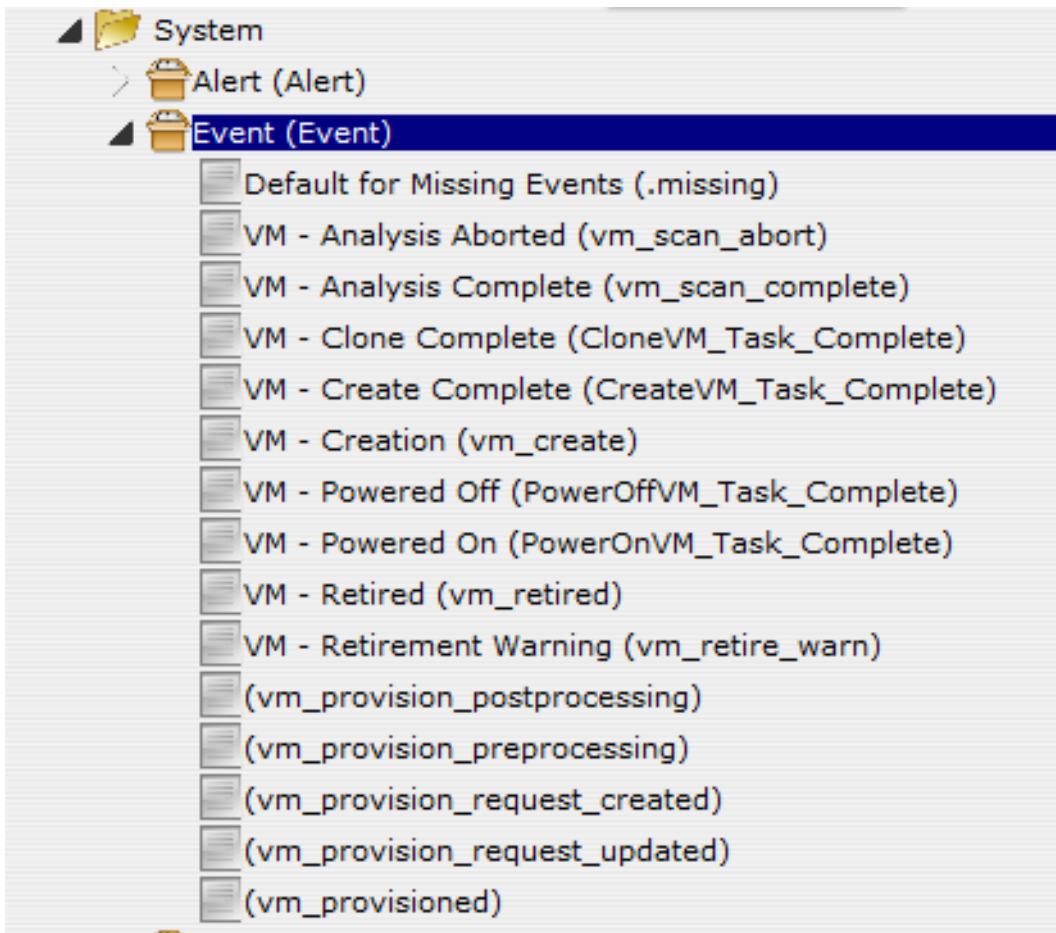

You can also use a CloudForms Management Engine Policy Event to initiate automation. You can either use the provided Raise Automation Event action or create a custom automation action. The first case will start in the `/System/Process` class, but then go to the Event that initiated the Automate model in the `/System/Process/Event Class`. If you create your own custom action, it will start from the `/System/Process` class and then go to the `/System/Process/Request Class` instead.



For example, suppose that you always want the same Automate model to occur when a virtual machine is created. You would use the Raise Automation Event Action. There are instances in the `/System/Process/Event Class` for the following Events that you can select as part of a Policy:



### 3.9. CREATING A POLICY FOR AUTOMATE

This procedure shows you how to create a policy for automate.

1. Navigate to **Control** → **Explorer**.
2. Click the **Policies** accordion, and select **Control Policies**.
3. Select **VM Control Policies**.
4. Click  (**Configuration**), then  (**Add a New Control Vm Policy**).
5. Type in a **Description**.
6. Uncheck **Active** if you do not want this policy processed even when assigned to a resource.
7. Click **Add**. You are brought to the page where you add conditions and events to your new policy.
8. Click  (**Configuration**), then  (**Edit this Policy's Event assignments**).
  - Check the events you want to use to send to an **Automate Model**.
  - Click **Save**.
  - From the **Events** area, click on the **Description** of the **Event** you want to assign an action to.

- Click  (Edit Actions for this Policy Event).
9. Select **Raise Automation Event**, and click  (Move selected Actions into this Event).
  10. Click **Save**.

You can now assign this policy to a **Policy Profile**. Then, assign the policy profile to the virtual machines. Every time this event happens on the virtual machine the appropriate Automate Model will be initiated.





#### NOTE

If you want the policy to initiate an Automate Model from the `/System/Process/Request` class, then you can create your own custom action. Be sure to have an instance in the `/System/Process/Request` class for it to map to.

### 3.10. CREATING A CUSTOM AUTOMATE ACTION

This procedure shows you how to create a custom Automate action.

1. Navigate to **Control** → **Explorer** accordion.
2. Click the **Actions** accordion.
3. Click  (**Configuration**), then  (**Add a new Action**).
4. Type in a **Description** for the Action.
5. Select **Invoke a Custom Automation** from **Action Type**.
6. In **Custom Automation**,
  - For **Message**, type `create`.
  - For **Request**, type in the name of the instance of the `/System/Process/Request Class` in the second.
7. Type in the **Attribute/Value Pairs** fields if applicable.
8. Click **Add**.

The action is created and can be added to a policy.



## APPENDIX A. OBJECTS

### A.1. VIRTUAL MACHINE PROPERTIES

When using these items in a method, prefix them with `vm..` For example: `vm.storage_id`.

**Table A.1. Virtual Machine Properties**

Friendly Name or Description	Raw Column Name
Allocated Disk Storage	<code>allocated_disk_storage</code>
Autostart	<code>autostart</code>
Blackbox Exists	<code>blackbox_exists</code>
Blackbox Validated	<code>blackbox_validated</code>
Boot Time	<code>boot_time</code>
Busy	<code>busy</code>
Cluster	<code>ems_cluster_name</code>
Configuration XML	<code>config_xml</code>
Connection State	<code>connection_state</code>
CPU Affinity	<code>cpu_affinity</code>
CPU Limit	<code>cpu_limit</code>
CPU Reserve	<code>cpu_reserve</code>
CPU Reserve Expand	<code>cpu_reserve_expand</code>
CPU Shares	<code>cpu_shares</code>
CPU Shares Level	<code>cpu_shares_level</code>
Created on Time	<code>ems_created_on</code>
Currently Used Space	<code>used_storage_by_state</code>
Datastore Path	<code>v_datastore_path</code>
Date Created	<code>created_on</code>

Friendly Name or Description	Raw Column Name
Date Updated	updated_on
Description	description
Ems	ems_id
Evm Owner	evm_owner_id
Evm Owner Email	evm_owner_email
Evm Owner Name	evm_owner_name
CloudForms Management Engine Unique ID (Guid)	guid
Format	format
Host	host_id
Host Name	host_name
Id	id
Is a Template	v_is_a_template
Last Analysis Attempt On	last_scan_attempt_on
Last Analysis Time	last_scan_on
Last Compliance Status	last_compliance_status
Last Compliance Timestamp	last_compliance_timestamp
Last Perf Capture On	last_perf_capture_on
Last Sync Time	last_sync_on
Location	location
Memory Limit	memory_limit
Memory Reserve	memory_reserve
Memory Reserve Expand	memory_reserve_expand

Friendly Name or Description	Raw Column Name
Memory Shares	memory_shares
Memory Shares Level	memory_shares_level
Name	name
OS Name	os_image_name
Owner	owner
Paravirtualization	paravirtualization
Parent Cluster	v_owning_cluster
Parent Datacenter	v_owning_datacenter
Parent Folder (Hosts & Clusters)	v_owning_folder
Parent Folder (VMs & Templates)	v_owning_blue_folder
Parent Folder Path (Hosts & Clusters)	v_owning_folder_path
Parent Folder Path (VMs & Templates)	v_owning_blue_folder_path
Parent Host Platform	v_host_vmm_product
Parent Resource Pool	v_owning_resource_pool
Pct Free Disk	v_pct_free_disk_space
Platform	platform
Power State	power_state
Previous State	previous_state
Registered	registered
Reserved	reserved
Retired	retired
Retirement	retirement
Retires On	retires_on

Friendly Name or Description	Raw Column Name
Service	service_id
Smart	smart
Standby Action	standby_action
State Changed On	state_changed_on
Storage	storage_id
Storage Name	storage_name
Template	template
Thin Provisioned	thin_provisioned
Tools Status	tools_status
Total Provisioned Space	provisioned_storage
Total Snapshots	v_total_snapshots
Total Used Disk Space	used_disk_storage
Uid Ems	uid_ems
Uncommitted Space	uncommitted_storage
Used Storage	used_storage
V Pct Used Disk Space	v_pct_used_disk_space
VDI Available	vdi_available
VDI Connection DNS Name	vdi_connection_dns_name
VDI Connection Logon Server	vdi_connection_logon_server
VDI Connection Name	vdi_connection_name
VDI Connection Remote IP Address	vdi_connection_remote_ip_address
VDI Connection Session Name	vdi_connection_session_name
VDI Connection Session Type	vdi_connection_session_type

Friendly Name or Description	Raw Column Name
VDI Connection URL	vdi_connection_url
VDI Endpoint IP Address	vdi_endpoint_ip_address
VDI Endpoint MAC Address	vdi_endpoint_mac_address
VDI Endpoint Name	vdi_endpoint_name
VDI Endpoint Type	vdi_endpoint_type
VDI User Appdata	vdi_user_appdata
VDI User DNS Domain	vdi_user_dns_domain
VDI User Domain	vdi_user_domain
VDI User Home Drive	vdi_user_home_drive
VDI User Home Path	vdi_user_home_path
VDI User Home Share	vdi_user_home_share
VDI User Logon Time	vdi_user_logon_time
VDI User Name	vdi_user_name
Vendor	vendor
Version	version
VMsafe Agent Address	vmsafe_agent_address
VMsafe Agent Port	vmsafe_agent_port
VMsafe Enable	vmsafe_enable
VMsafe Fail Open	vmsafe_fail_open
VMsafe Immutable VM	vmsafe_immutable_vm
VMsafe Timeout (ms)	vmsafe_timeout_ms

## A.2. CLOUDFORMS MANAGEMENT ENGINE METHODS FOR USE IN RUBY SCRIPTS

To use one of these in one of your own Ruby methods, use the syntax of `vm.method`. For example, to reboot the guest operating system, use `vm.rebootGuest`.

Method	Description
<code>start</code>	Start Virtual Machine container.
<code>stop</code>	Stop Virtual Machine container.
<code>suspend</code>	Suspend Virtual Machine container.
<code>unregister</code>	Unregister Virtual Machine.
<code>collect_running_processes</code>	Collect the running processes from a started Virtual Machine.
<code>shutdownGuest</code>	Shutdown the guest operating system of the VM container. Requires VMware tools (or vendors tools) installed on the guest.
<code>standbyGuest</code>	Put the guest operating system into standby. Requires VMware tools (or vendors tools) installed on the guest.
<code>rebootGuest</code>	Reboot the guest operating system. Requires VMware tools (or vendors tools) installed on the guest.

### A.3. HOST PROPERTIES

When using these items in a method, prefix them with `host`, such as `host.ems_id`.

Friendly Name or Description	Raw Column Name
All Enabled Ports	<code>all_enabled_ports</code>
Annotation	<code>v_annotation</code>
Authentication Status	<code>Authentication_status</code>
Connection State	<code>connection_state</code>
CPU usage MHz rate average over time period	<code>cpu_usagemhz_rate_average_avg_over_time_period</code>
CPU usage MHz rate high over time period	<code>cpu_usagemhz_rate_average_high_over_time_perio d</code>

Friendly Name or Description	Raw Column Name
CPU usage MHz rate low over time period	cpu_usagemhz_rate_average_low_over_time_period
Custom Attribute 1	custom_1
Custom Attribute 2	custom_2
Custom Attribute 3	custom_3
Custom Attribute 4	custom_4
Custom Attribute 5	custom_5
Custom Attribute 6	custom_6
Custom Attribute 7	custom_7
Custom Attribute 8	custom_8
Custom Attribute 9	custom_9
Date Created	created_on
Derived memory usage average over time period	derived_memory_used_avg_over_time_period
Derived memory usage high over time period	derived_memory_used_high_over_time_period
Derived memory usage low over time period	derived_memory_used_low_over_time_period
Ems	ems_id
Enabled Inbound Ports	enabled_inbound_ports
Enabled Outbound Ports	enabled_outbound_ports
Enabled Run Level 0 Services	enabled_run_level_0_services
Enabled Run Level 1 Services	enabled_run_level_1_services
Enabled Run Level 2 Services	enabled_run_level_2_services
Enabled Run Level 3 Services	enabled_run_level_3_services
Enabled Run Level 4 Services	enabled_run_level_4_services
Enabled Run Level 5 Services	enabled_run_level_5_services

Friendly Name or Description	Raw Column Name
Enabled Run Level 6 Services	enabled_run_level_6_services
Enabled TCP Inbound Ports	enabled_tcp_inbound_ports
Enabled TCP Outbound Ports	enabled_tcp_outbound_ports
Enabled UDP Inbound Ports	enabled_udp_inbound_ports
Enabled UDP Outbound Ports	enabled_udp_outbound_ports
EVM Unique ID (Guid)	guid
Hostname	hostname
Id	id
IP Address	ipaddress
Last Compliance Status	last_compliance_status
Last Compliance Timestamp	last_compliance_timestamp
Last Perf Capture On	last_perf_capture_on
Last Analysis Time	last_scan_on
Name	name
OS Name	os_image_name
Platform	platform
Power State	power_state
Region Description	region_description
Region Number	region_number
Reserved	reserved
Service Names	service_names
Settings	settings
Smart	smart



Friendly Name or Description	Raw Column Name
SSH Root Access	ssh_permit_root_login
Uid Ems	uid_ems
Date Updated	updated_on
User Assigned Os	user_assigned_os
Parent Cluster	v_owning_cluster
Parent Datacenter	v_owning_datacenter
Parent Folder (Hosts & Clusters)	v_owning_folder
Total Datastores	v_total_storages
Total VMs	v_total_vms
VMM Build Number	vmm_buildnumber
VMM Platform	vmm_product
VMM Vendor	vmm_vendor
VMM Version	vmm_version

## A.4. PROVIDER PROPERTIES

When using these items in a method, prefix them with `ems`, such as `ems.ems_id`.

Friendly Name or Description	Raw Column Name
Aggregate VM CPUs	aggregate_vm_cpus
Aggregate VM Memory	aggregate_vm_memory
CPU Ratio	v_cpu_vr_ratio
CPU Usage MHZ Rate Average High Over Time Period	cpu_usagemhz_rate_average_high_over_time_period"
CPU Usage MHZ Rate Average Low Over Time Period	cpu_usagemhz_rate_average_low_over_time_period

Friendly Name or Description	Raw Column Name
CPU Usage MHZ Rate Average Over Time Period	cpu_usagemhz_rate_average_avg_over_time_period
Date Created	created_on
Date Updated	updated_on
Derived Memory Usage Rate Average High Over Time Period	derived_memory_used_high_over_time_period
Derived Memory Usage Rate Average Low Time Period	derived_memory_used_low_over_time_period
Derived Memory Usage Rate Average Over Time Period	derived_memory_used_avg_over_time_period
Distributed Resource Scheduler Automation Level	drs_automation_level
Distributed Resource Scheduler Enabled	drs_enabled
Distributed Resource Scheduler Migration Threshold	drs_migration_threshold
EMS ID	ems_id
EVM Zone	zone_name
High-Availability Admission Control	ha_admit_control
High-Availability Enabled	ha_enabled
High-Availability Max Failures	ha_max_failures
Id	id
Last Performance Data Captured	last_perf_capture_on
Last Smart State Analysis	last_scan_on
Memory Ratio	v_ram_vr_ratio
Name	name
Parent Datacenter	v_parent_datacenter
Qualified Description	v_qualified_desc

Friendly Name or Description	Raw Column Name
Region Description	region_description
Region Number	region_number
Reserved	reserved
Total CPU Speed	aggregate_cpu_speed
Total Hosts	total_hosts
Total Memory	aggregate_memory
Total Number of Logical CPUs	aggregate_logical_cpus
Total Number of Physical CPUs	aggregate_physical_cpus
Total Vms	total_vms
Unique Identifier	uid_ems

## A.5. STORAGE PROPERTIES

When using these items in a method, prefix them with `storage`, such as `storage.name`.

**Table A.2. Storage Properties**

Friendly Name or Description	Raw Column Name
Date Created	created_on
Date Updated	updated_on
Disk Files Percent of Used	v_disk_percent_of_used
Free Space	free_space
Free Space Percent of Total	v_free_space_percent_of_total
Id	id
Last Analysis Time	last_scan_on
Last Perf Capture On	last_perf_capture_on
Location	location

Friendly Name or Description	Raw Column Name
Multiple Host Access	multiplehostaccess
Name	name
Non-VM Files Percent of Used	v_debris_percent_of_used
Other VM Files Percent of Used	v_vm_misc_percent_of_used
Provisioned Space Percent of Total	v_provisioned_percent_of_total
Reserved	reserved
Size of Non-VM Files	v_total_debris_size
Size of Other VM Files	v_total_vm_misc_size
Size of VM Memory Files	v_total_vm_ram_size
Size of VM Snapshot Files	v_total_snapshot_size
Snapshot Files Percent of Used	v_snapshot_percent_of_used
Store Type	store_type
Total Hosts	v_total_hosts
Total Managed Registered Vms	total_managed_registered_vms
Total Managed Unregistered Vms	total_managed_unregistered_vms
Total Provisioned Space	v_total_provisioned
Total Space	total_space
Total Unmanaged Vms	total_unmanaged_vms
Total VMs	v_total_vms
Uncommitted	uncommitted
Used Space	v_used_space
Used Space Percent of Total	v_used_space_percent_of_total
VM Memory Files Percent of Used	v_memory_percent_of_used

## APPENDIX B. FAQs AND FLOWS

### B.1. PHASE 1: CREATE PROVISION REQUEST

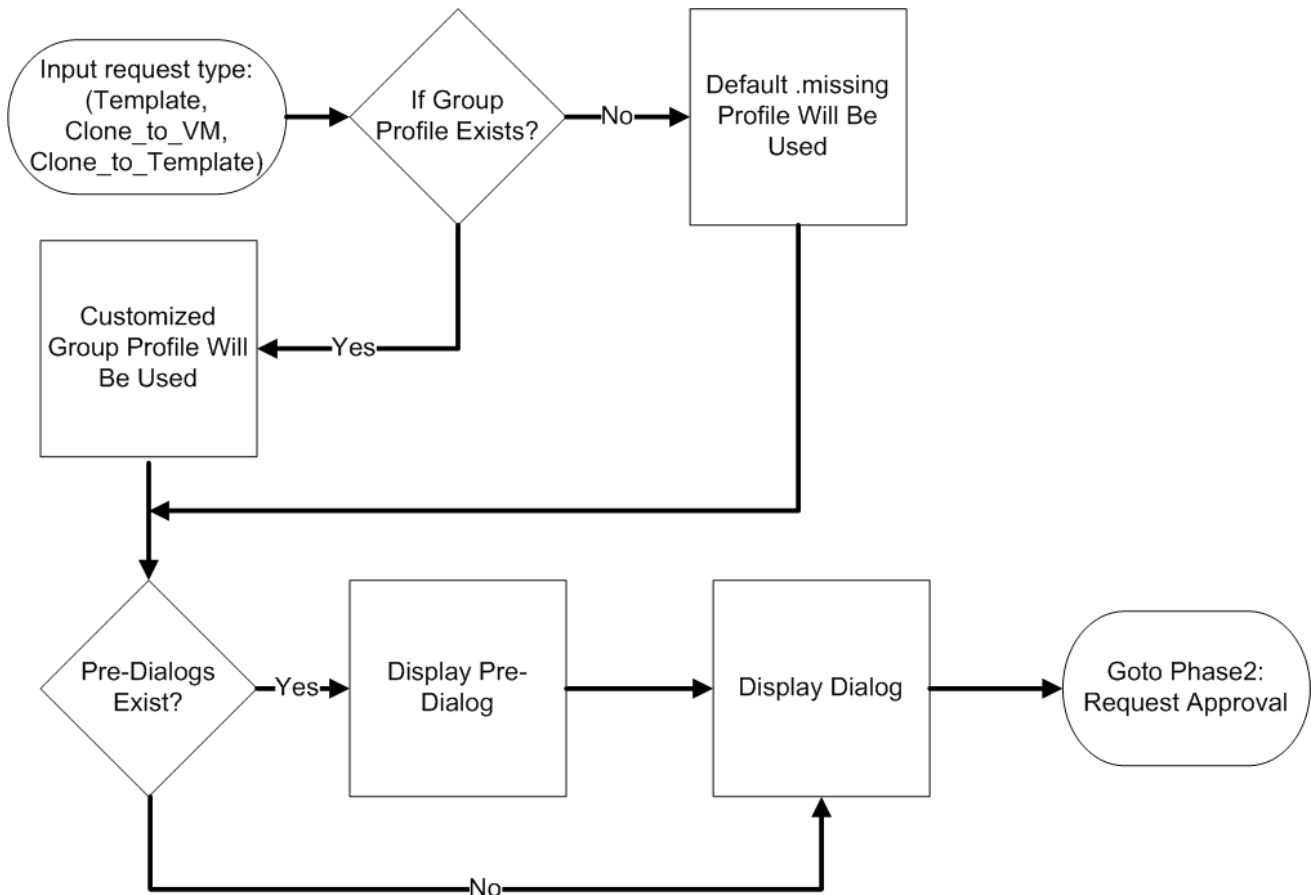

Question	Answer
Where do I create a new provisioning profile based on a users LDAP group?	Navigate to [VM / Provisioning / Profile] of either the Cloud or Infrastructure namespace in your domain.
Where can I specify a pre-dialog to present to a Requester in their LDAP group?	Custom pre-dialogs can be defined in [VM / Provisioning / Profile / <LDAP Group Name>] of either the Cloud or Infrastructure namespace in your domain.
I would like to customize our dialogs. Where are all the dialogs kept?	All dialogs are located on each CloudForms Management Engine Appliance in the [/var/www/miq/vmdb/db/fixtures] directory.
What happens if I do not specify any profiles for provisioning?	CloudForms Management Engine searches for a matching LDAP group in the [VM / Provisioning / Profile] class of either the Cloud or Infrastructure namespace in your domain. If an LDAP profile is NOT found then CloudForms Management Engine will use the .missing class instance.

## B.2. PHASE 2: REQUEST APPROVAL

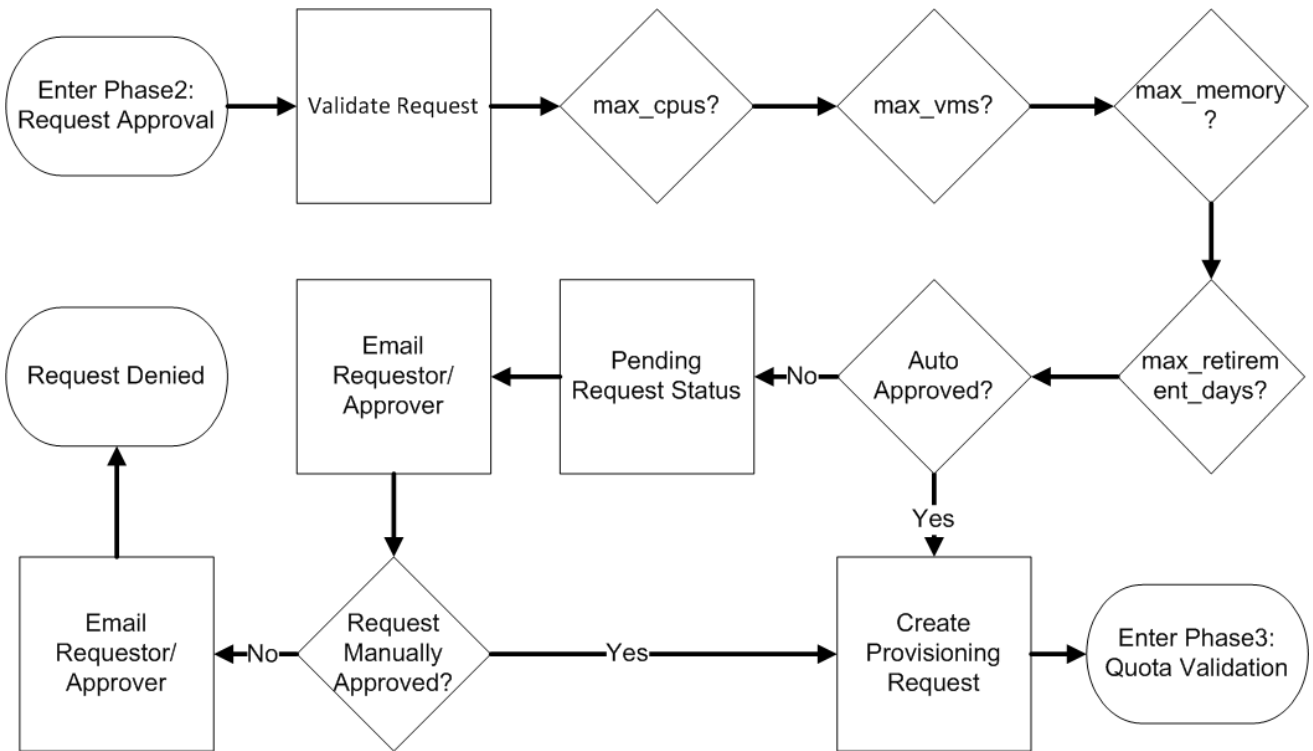

Question	Answer
Where can I specify auto-approval values on a per virtual machine template basis?	Tags can be assigned to templates in the form of [prov_max_vms, prov_max_cpus, prov_max_memory, prov_max_retirement_days].
Where can I modify the default Auto-Approval values?	These values can be set in the [Service / Provisioning / StateMachines / ServiceProvisionRequestApproval / Default] class instance in your domain.
How can I customize the email that is sent when a request is approved?	The Request Approved email message can be modified in [VM / Provisioning / Email / MiqProvisionRequest_Approved] in either the Cloud or Infrastructure namespace of your domain.
How can I customize the email that is sent when a request is denied?	The Request Denied email message can be modified in [VM / Provisioning / Email / MiqProvisionRequest_Denied] in either the Cloud or Infrastructure namespace of your domain.
How can I customize the email that is sent when a request is not Auto-approved?	The Request Pending email message can be modified in [VM / Provisioning / Email / MiqProvisionRequest_Denied] in either the Cloud or Infrastructure namespace of your domain.
If a Request Approval requires manual approval, how does an Approver approve the request?	Log into CloudForms Management Engine as an approver/admin and Navigate to <b>Virtual Machines</b> → <b>Requests</b> and then click on the request.

## B.3. PHASE 3: QUOTA VALIDATION

Question	Answer
Where in CloudForms Management Engine can I set default quota thresholds for users and groups?	These values can be set in the [VM / Provisioning / StateMachines / ProvisionRequestQuotaVerification] class instance of either the Cloud or Infrastructure namespace in your domain.
Where in CloudForms Management Engine can I set individual and group quota thresholds?	Tags can be assigned to groups or users by navigating to <b>Configuration</b> → <b>Access Control</b> . The following are valid tags that can be assigned to group or individual users: [quota_max_cpu, quota_max_memory, quota_max_storage].
Where can I customize the way our virtual machines are named?	Virtual machine naming conventions can be altered using the methods in the [VM / Provisioning / Naming] class of either the Cloud or Infrastructure namespace in your domain.
How can I customize the email that is sent when a request is denied?	The Request Denied email message can be modified in the [VM / Provisioning / Email / MiqProvisionRequest_Denied] in either the Cloud or Infrastructure namespace of your domain.

## B.4. PHASE 4: PROVISIONING

Figure B.1. Target Type: Cloning a Template to a Virtual Machine

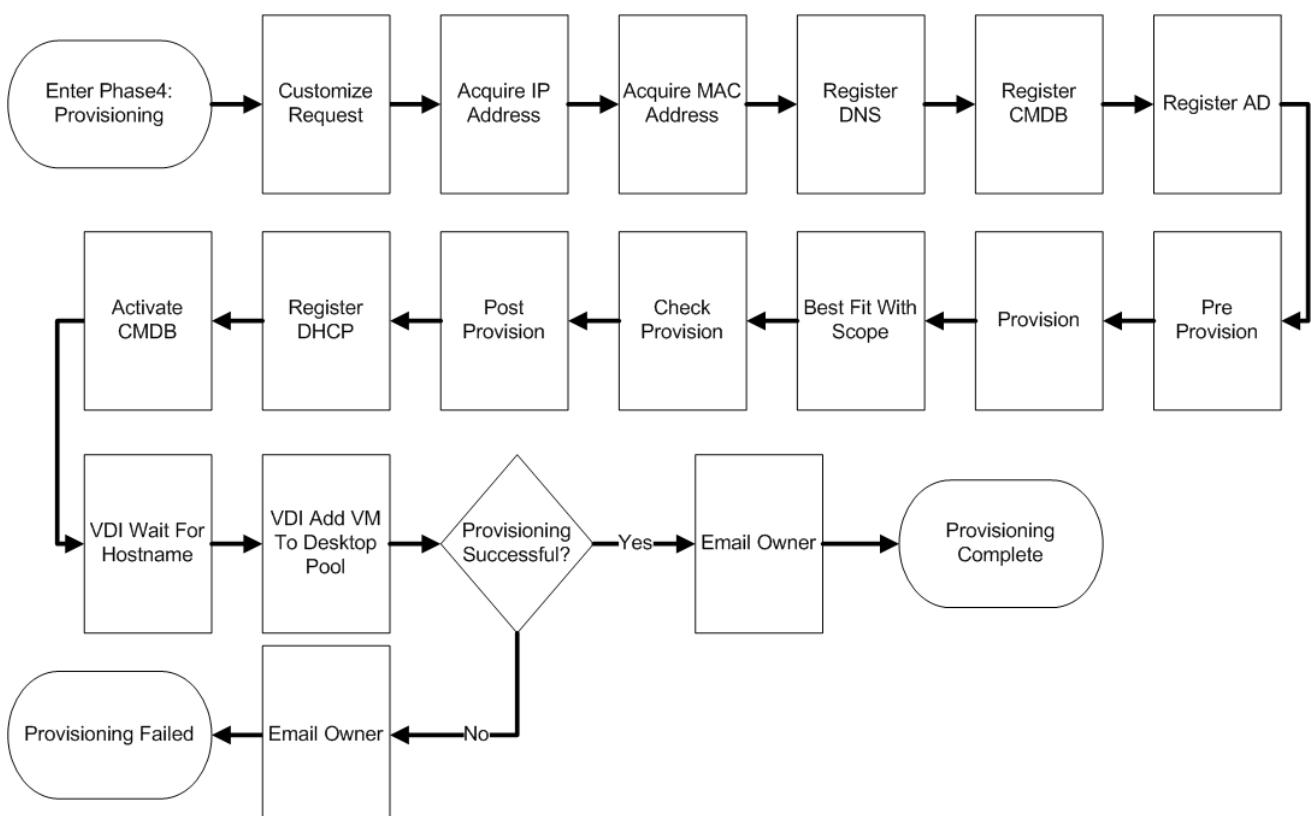

**Figure B.2. Target Type: Clone to Template**

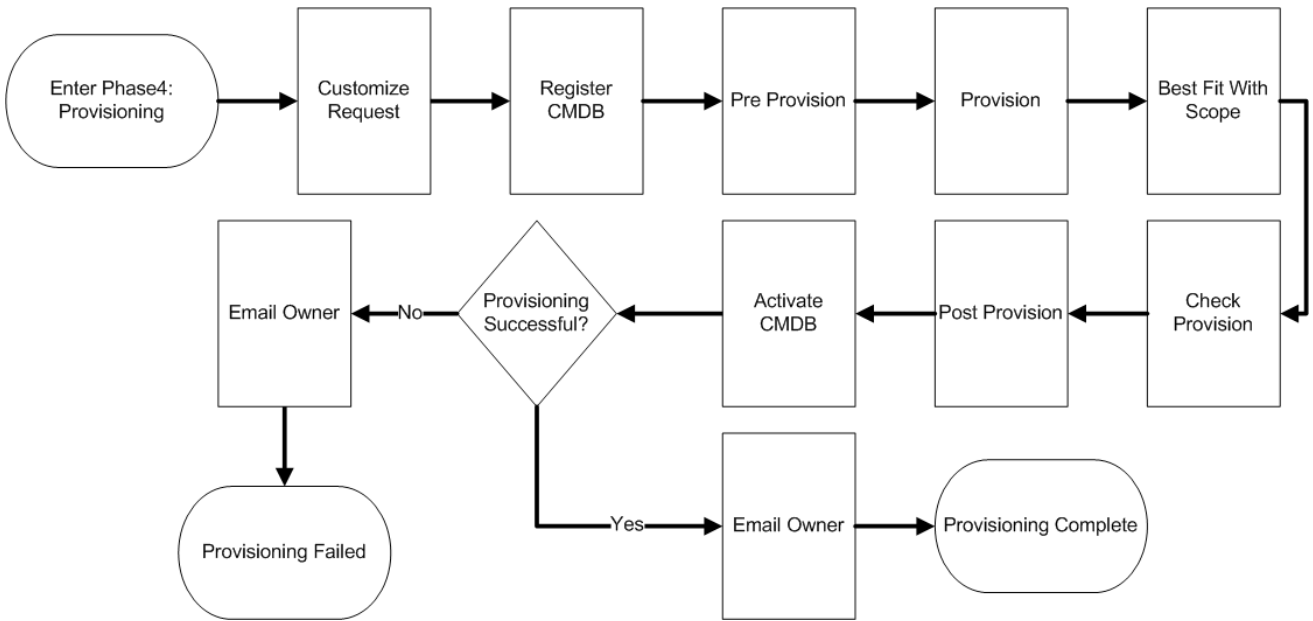

Question	Answer
Where can I customize the email message that is sent upon provisioning completion?	This can be customized using the [VM / Provisioning / Email / MiqProvision_Complete] in either the Cloud or Infrastructure namespace of your domain.
Where can I change what is put into the virtual machines Annotation after provisioning?	These settings can be modified by leveraging the *_PreProvision Ruby methods in [VM / Provisioning / StateMachines / Methods] in either the Cloud or Infrastructure namespace of your domain.
Where do I set the default VC folder location for provisioning virtual machines?	This can be modified by leveraging by leveraging the *_PreProvision Ruby methods in [VM / Provisioning / StateMachines / Methods] in either the Cloud or Infrastructure namespace of your domain.
Where can I modify the virtual machine customization spec mapping?	This can be modified by leveraging by leveraging the *_PreProvision Ruby methods in [VM / Provisioning / StateMachines / Methods] in either the Cloud or Infrastructure namespace of your domain.
Where can I modify the Clone_to_Template state_machine?	Navigate to [VM / Provisioning / StateMachines / VMProvision_VM / template ] in either the Cloud or Infrastructure namespace of your domain.
Where can I modify the Clone_to_VM state_machine?	Navigate to [VM / Provisioning / StateMachines / VMProvision_VM / clone_to_vm ] in either the Cloud or Infrastructure namespace of your domain.

## B.5. PHASE 5: RETIREMENT



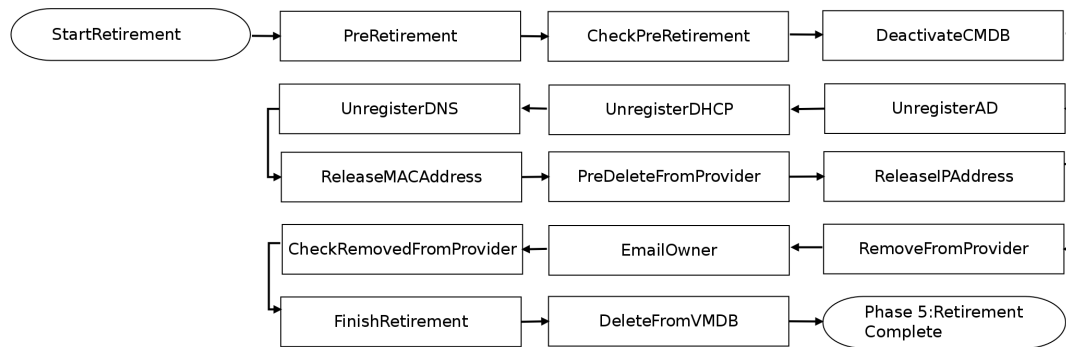

Question	Answer
Where can I customize the email message that is sent upon completion of virtual machine retirement?	This can be customized using the [VM / Retirement / Email / vm_retirement_emails] in either the Cloud or Infrastructure namespace of your domain.
Where can I customize the email message that is sent during virtual machine retirement warnings?	This can be customized using the [VM / Retirement / Email / vm_retirement_emails] in either the Cloud or Infrastructure namespace of your domain.
If I want to customize what gets called during the retirement phase where should I look?	This can be customized using the [VM / Retirement / StateMachines / VMRetirement] in either the Cloud or Infrastructure namespace of your domain.
How can I extend the virtual machine retirement date an additional number of days?	Create a custom button for virtual machines that launches [/System/Request/vm_retire_extend]. Then navigate to the [VM / Retirement / Email / vm_retire_extend] Ruby method in the Cloud and Infrastructure namespaces and set the vm_retire_extend_days value.

## APPENDIX C. INLINE METHOD TO CREATE A PROVISION REQUEST

### C.1. RUBY METHOD

```
# CloudForms Management Engine Automate Method
#
$evm.log("info", "CloudForms Management Engine Automate Method Building
VM Provisioning Request Started")
#

prov= $evm.root['miq_provision']

# arg1 = version
args = ['1.1']
# arg2 = templateFields
args << {'name' => 'App'}
# arg3 = vmFields
args << {'vm_name' => 'CRM_APP', 'request_type' => 'template'}
# arg4 = requester
args << {'owner_email' => 'admin@asd.com', 'owner_last_name' => 'Admin',
'owner_first_name' => 'Admin', 'user_name' => 'admin'}
# arg5 = tags
args << {'crm' => 'true'}
# arg6 = WS Values
args << nil
# arg7 = emsCustomAttributes
args << nil
# arg8 = miqCustomAttributes
args << nil

$evm.log("info", "Building provisioning request with the following
arguments: <#{args.inspect}>")
result = $evm.execute('create_provision_request', *args)
```