



Red Hat Process Automation Manager 7.11

Getting started with Red Hat Process Automation Manager

Legal Notice

Copyright © 2023 Red Hat, Inc.

The text of and illustrations in this document are licensed by Red Hat under a Creative Commons Attribution–Share Alike 3.0 Unported license ("CC-BY-SA"). An explanation of CC-BY-SA is available at

<http://creativecommons.org/licenses/by-sa/3.0/>

. In accordance with CC-BY-SA, if you distribute this document or an adaptation of it, you must provide the URL for the original version.

Red Hat, as the licensor of this document, waives the right to enforce, and agrees not to assert, Section 4d of CC-BY-SA to the fullest extent permitted by applicable law.

Red Hat, Red Hat Enterprise Linux, the Shadowman logo, the Red Hat logo, JBoss, OpenShift, Fedora, the Infinity logo, and RHCE are trademarks of Red Hat, Inc., registered in the United States and other countries.

Linux[®] is the registered trademark of Linus Torvalds in the United States and other countries.

Java[®] is a registered trademark of Oracle and/or its affiliates.

XFS[®] is a trademark of Silicon Graphics International Corp. or its subsidiaries in the United States and/or other countries.

MySQL[®] is a registered trademark of MySQL AB in the United States, the European Union and other countries.

Node.js[®] is an official trademark of Joyent. Red Hat is not formally related to or endorsed by the official Joyent Node.js open source or commercial project.

The OpenStack[®] Word Mark and OpenStack logo are either registered trademarks/service marks or trademarks/service marks of the OpenStack Foundation, in the United States and other countries and are used with the OpenStack Foundation's permission. We are not affiliated with, endorsed or sponsored by the OpenStack Foundation, or the OpenStack community.

All other trademarks are the property of their respective owners.

Abstract

This document describes how to get started with decision services, process services, and planning solutions in Red Hat Process Automation Manager.

Table of Contents

| | |
|--|-----------|
| PREFACE | 6 |
| MAKING OPEN SOURCE MORE INCLUSIVE | 7 |
| PART I. GETTING STARTED WITH DECISION SERVICES IN RED HAT PROCESS AUTOMATION MANAGER | 8 |
| CHAPTER 1. SAMPLE PROJECTS AND BUSINESS ASSETS IN BUSINESS CENTRAL | 9 |
| 1.1. ACCESSING SAMPLE PROJECTS AND BUSINESS ASSETS IN BUSINESS CENTRAL | 9 |
| CHAPTER 2. RED HAT PROCESS AUTOMATION MANAGER BPMN AND DMN MODELERS | 11 |
| 2.1. INSTALLING THE RED HAT PROCESS AUTOMATION MANAGER VSCODE EXTENSION BUNDLE | 11 |
| 2.2. CONFIGURING THE RED HAT PROCESS AUTOMATION MANAGER STANDALONE EDITORS | 12 |
| CHAPTER 3. CREATING AND EXECUTING DMN AND BPMN MODELS USING MAVEN | 16 |
| CHAPTER 4. CREATING THE TRAFFIC VIOLATIONS PROJECT IN BUSINESS CENTRAL | 18 |
| CHAPTER 5. DECISION MODEL AND NOTATION (DMN) | 19 |
| 5.1. CREATING THE TRAFFIC VIOLATIONS DMN DECISION REQUIREMENTS DIAGRAM (DRD) | 19 |
| 5.2. CREATING THE TRAFFIC VIOLATIONS DMN CUSTOM DATA TYPES | 21 |
| 5.3. ASSIGNING CUSTOM DATA TYPES TO THE DRD INPUT AND DECISION NODES | 25 |
| 5.4. DEFINING THE TRAFFIC VIOLATIONS DMN DECISION LOGIC | 26 |
| CHAPTER 6. TEST SCENARIOS | 29 |
| 6.1. TESTING THE TRAFFIC VIOLATIONS USING TEST SCENARIOS | 29 |
| CHAPTER 7. DMN MODEL EXECUTION | 33 |
| 7.1. EXECUTING A DMN SERVICE USING THE KIE SERVER REST API | 33 |
| CHAPTER 8. ADDITIONAL RESOURCES | 48 |
| PART II. GETTING STARTED WITH PROCESS SERVICES IN RED HAT PROCESS AUTOMATION MANAGER .. | 49 |
| CHAPTER 9. OVERVIEW | 50 |
| CHAPTER 10. SAMPLE PROJECTS AND BUSINESS ASSETS IN BUSINESS CENTRAL | 51 |
| 10.1. ACCESSING SAMPLE PROJECTS AND BUSINESS ASSETS IN BUSINESS CENTRAL | 51 |
| CHAPTER 11. CREATING USERS | 53 |
| CHAPTER 12. CREATING AND EXECUTING DMN AND BPMN MODELS USING MAVEN | 55 |
| CHAPTER 13. CREATING THE MORTGAGE-PROCESS PROJECT | 57 |
| CHAPTER 14. CREATING THE MORTGAGE-PROCESS DATA OBJECTS | 58 |
| 14.1. CREATING THE APPLICANT DATA OBJECT | 58 |
| 14.2. CREATING THE PROPERTY DATA OBJECT | 59 |
| 14.3. CREATING THE VALIDATIONERRORDO DATA OBJECT | 59 |
| 14.4. CREATING THE APPLICATION DATA OBJECT | 60 |
| CHAPTER 15. BUSINESS PROCESSES IN BUSINESS CENTRAL | 62 |
| 15.1. CREATING THE BUSINESS PROCESS | 62 |
| 15.1.1. Creating outgoing connections and exclusive gateways | 63 |
| 15.1.2. Defining the validation data | 66 |
| 15.1.3. Calculating the mortgage | 69 |
| 15.1.4. Increasing the down payment | 74 |

| | |
|---|------------|
| CHAPTER 16. GUIDED RULES | 79 |
| 16.1. VIEWING THE MORTGAGE_PROCESS BUSINESS RULES | 79 |
| 16.1.1. Viewing the Validate Down Payment guided rule | 79 |
| 16.1.2. Viewing the RetractValidationErr guided rule | 79 |
| CHAPTER 17. GUIDED DECISION TABLES | 81 |
| 17.1. VIEWING THE MORTGAGE DECISION TABLE | 81 |
| CHAPTER 18. FORMS IN BUSINESS CENTRAL | 82 |
| 18.1. VIEWING THE MORTGAGE_PROCESS FORMS | 82 |
| CHAPTER 19. DEPLOYING THE MORTGAGEAPPROVALPROCESS PROCESS APPLICATION | 85 |
| CHAPTER 20. EXECUTING THE MORTGAGEAPPROVALPROCESS PROCESS APPLICATION | 86 |
| CHAPTER 21. MONITORING THE MORTGAGEAPPROVALPROCESS PROCESS APPLICATION | 88 |
| 21.1. FILTERING PROCESS INSTANCES USING DEFAULT OR ADVANCED FILTERS | 88 |
| 21.1.1. Filtering process instances using default filters | 88 |
| 21.1.2. Filtering process instances using advanced filters | 89 |
| CHAPTER 22. ADDITIONAL RESOURCES | 91 |
| PART III. GETTING STARTED WITH CASE MANAGEMENT IN RED HAT PROCESS AUTOMATION MANAGER | 92 |
| CHAPTER 23. REVIEWING THE IT_ORDERS SAMPLE PROJECT | 93 |
| CHAPTER 24. CREATING A NEW IT_ORDERS CASE PROJECT | 94 |
| CHAPTER 25. DATA OBJECTS | 96 |
| 25.1. CREATING THE ITORDERSERVICE DATA OBJECT | 96 |
| 25.2. CREATING THE SURVEY DATA OBJECT | 96 |
| CHAPTER 26. DESIGNING THE CASE DEFINITION | 98 |
| 26.1. CREATING THE PLACE ORDER SUB-PROCESS | 100 |
| 26.2. CREATING THE MANAGER APPROVAL BUSINESS PROCESS | 105 |
| CHAPTER 27. MILESTONES | 113 |
| 27.1. CREATING THE HARDWARE SPEC READY MILESTONE | 113 |
| 27.2. CREATING THE MANAGER DECISION MILESTONE | 114 |
| 27.3. CREATING THE ORDER PLACED MILESTONE | 115 |
| 27.4. CREATING THE ORDER SHIPPED MILESTONE | 116 |
| 27.5. CREATING THE DELIVERED TO CUSTOMER MILESTONE | 117 |
| CHAPTER 28. DEPLOYING AND TESTING THE IT ORDER CASE PROJECT | 120 |
| CHAPTER 29. ADDITIONAL RESOURCES | 121 |
| PART IV. GETTING STARTED WITH RED HAT BUILD OF OPTAPLANNER | 122 |
| CHAPTER 30. INTRODUCTION TO RED HAT BUILD OF OPTAPLANNER | 123 |
| 30.1. PLANNING PROBLEMS | 123 |
| 30.2. NP-COMPLETENESS IN PLANNING PROBLEMS | 124 |
| 30.3. SOLUTIONS TO PLANNING PROBLEMS | 124 |
| 30.4. CONSTRAINTS ON PLANNING PROBLEMS | 125 |
| CHAPTER 31. EXAMPLES PROVIDED WITH RED HAT BUILD OF OPTAPLANNER | 126 |
| 31.1. N QUEENS | 129 |

| | |
|--|------------|
| 31.1.1. Domain model for N queens | 131 |
| 31.2. CLOUD BALANCING | 132 |
| 31.3. TRAVELING SALESMAN (TSP - TRAVELING SALESMAN PROBLEM) | 132 |
| 31.4. TENNIS CLUB SCHEDULING | 133 |
| 31.5. MEETING SCHEDULING | 134 |
| 31.6. COURSE TIMETABLING (ITC 2007 TRACK 3 - CURRICULUM COURSE SCHEDULING) | 135 |
| 31.7. MACHINE REASSIGNMENT (GOOGLE ROADEF 2012) | 137 |
| 31.8. VEHICLE ROUTING | 140 |
| 31.8.1. Domain model for Vehicle routing | 145 |
| 31.9. PROJECT JOB SCHEDULING | 151 |
| 31.10. TASK ASSIGNING | 153 |
| 31.11. EXAM TIMETABLING (ITC 2007 TRACK 1 - EXAMINATION) | 155 |
| 31.11.1. Domain model for Exam timetabling | 157 |
| 31.12. NURSE ROSTERING (INRC 2010) | 158 |
| 31.13. TRAVELING TOURNAMENT PROBLEM (TTP) | 163 |
| 31.14. CHEAP TIME SCHEDULING | 165 |
| 31.15. INVESTMENT ASSET CLASS ALLOCATION (PORTFOLIO OPTIMIZATION) | 168 |
| 31.16. CONFERENCE SCHEDULING | 168 |
| 31.17. ROCK TOUR | 171 |
| 31.18. FLIGHT CREW SCHEDULING | 172 |
| CHAPTER 32. DOWNLOADING RED HAT BUILD OF OPTAPLANNER EXAMPLES | 173 |
| 32.1. RUNNING OPTAPLANNER EXAMPLES | 173 |
| 32.2. RUNNING THE RED HAT BUILD OF OPTAPLANNER EXAMPLES IN AN IDE (INTELLIJ, ECLIPSE, OR NETBEANS) | 174 |
| CHAPTER 33. GETTING STARTED WITH OPTAPLANNER IN BUSINESS CENTRAL: AN EMPLOYEE ROSTERING EXAMPLE | 175 |
| 33.1. DEPLOYING THE EMPLOYEE ROSTERING SAMPLE PROJECT IN BUSINESS CENTRAL | 175 |
| 33.2. RE-CREATING THE EMPLOYEE ROSTERING SAMPLE PROJECT | 175 |
| 33.2.1. Setting up the employee rostering project | 176 |
| 33.2.2. Problem facts and planning entities | 176 |
| 33.2.3. Creating the data model for the employee rostering project | 177 |
| 33.2.3.1. Creating the employee roster planning entity | 178 |
| 33.2.3.2. Creating the employee roster planning solution | 179 |
| 33.2.4. Employee rostering constraints | 180 |
| 33.2.4.1. DRL (Drools Rule Language) rules | 181 |
| 33.2.4.2. Defining constraints for employee rostering using the DRL designer | 182 |
| 33.2.5. Creating rules for employee rostering using guided rules | 183 |
| 33.2.5.1. Guided rules | 183 |
| 33.2.5.2. Creating a guided rule to balance employee shift numbers | 183 |
| 33.2.5.3. Creating a guided rule for no more than one shift per day | 184 |
| 33.2.5.4. Creating a guided rule to match skills to shift requirements | 185 |
| 33.2.5.5. Creating a guided rule to manage day off requests | 187 |
| 33.2.6. Creating a solver configuration for employee rostering | 188 |
| 33.2.7. Configuring Solver termination for the employee rostering project | 188 |
| 33.3. ACCESSING THE SOLVER USING THE REST API | 189 |
| 33.3.1. Registering the Solver using the REST API | 189 |
| 33.3.2. Calling the Solver using the REST API | 190 |
| CHAPTER 34. GETTING STARTED WITH OPTAPLANNER AND QUARKUS | 194 |
| 34.1. APACHE MAVEN AND RED HAT BUILD OF QUARKUS | 194 |
| 34.2. CONFIGURING THE MAVEN SETTINGS.XML FILE FOR THE ONLINE REPOSITORY | 194 |
| 34.3. DOWNLOADING AND CONFIGURING THE QUARKUS MAVEN REPOSITORY | 195 |

| | |
|---|------------|
| 34.4. CREATING A RED HAT BUILD OF QUARKUS MAVEN PROJECT USING CODE.QUARKUS.REDHAT.COM | 197 |
| APPENDIX A. VERSIONING INFORMATION | 200 |
| APPENDIX B. CONTACT INFORMATION | 201 |

PREFACE

As a developer of business decisions and processes , you can use Red Hat Process Automation Manager to develop decision services and process services using a variety of available assets. You can also use Red Hat build of OptaPlanner to find the optimal solution to planning problems based on a set of limited resources and under specific constraints.

MAKING OPEN SOURCE MORE INCLUSIVE

Red Hat is committed to replacing problematic language in our code, documentation, and web properties. We are beginning with these four terms: master, slave, blacklist, and whitelist. Because of the enormity of this endeavor, these changes will be implemented gradually over several upcoming releases. For more details, see [our CTO Chris Wright's message](#).

PART I. GETTING STARTED WITH DECISION SERVICES IN RED HAT PROCESS AUTOMATION MANAGER

As a business rules developer, you can use Business Central in Red Hat Process Automation Manager or the Red Hat Process Automation Manager DMN modeler in VSCode to design a variety of decision services. Red Hat Process Automation Manager provides example projects with example business assets directly in Business Central as a reference. This document describes how to create and test an example traffic violation project based on the **Traffic_Violation** sample project included in Business Central. This sample project uses a Decision Model and Notation (DMN) model to define driver penalty and suspension rules in a traffic violation decision service. You can follow the steps in this document to create the project and the assets it contains, or open and review the existing **Traffic_Violation** sample project.

For more information about the DMN components and implementation in Red Hat Process Automation Manager, see [Designing a decision service using DMN models](#) .

Prerequisites

- Red Hat JBoss Enterprise Application Platform 7.3 is installed. For installation information, see [Red Hat JBoss Enterprise Application Platform 7.3 Installation Guide](#) .
- Red Hat Process Automation Manager is installed and configured with KIE Server. For more information see [Installing and configuring Red Hat Process Automation Manager on Red Hat JBoss EAP 7.3](#).
- Red Hat Process Automation Manager is running and you can log in to Business Central with the **developer** role. For more information, see [Planning a Red Hat Process Automation Manager installation](#).

CHAPTER 1. SAMPLE PROJECTS AND BUSINESS ASSETS IN BUSINESS CENTRAL

Business Central contains sample projects with business assets that you can use as a reference for the rules, processes, or other assets that you create in your own Red Hat Process Automation Manager projects. Each sample project is designed differently to demonstrate process automation, decision management, or business optimization assets and logic in Red Hat Process Automation Manager.



NOTE

Red Hat does not provide support for the sample code included in the Red Hat Process Automation Manager distribution.

The following sample projects are available in Business Central:

- **Course_Scheduling:** (Business optimization) Course scheduling and curriculum decision process. Assigns lectures to rooms and determines a student's curriculum based on factors, such as course conflicts and class room capacity.
- **Dinner_Party:** (Business optimization) Guest seating optimization using guided decision tables. Assigns guest seating based on each guest's job type, political beliefs, and known relationships.
- **Employee_Rostering:** (Business optimization) Employee rostering optimization using decision and solver assets. Assigns employees to shifts based on skills.
- **Evaluation_Process:** (Process automation) Evaluation process using business process assets. Evaluates employees based on performance.
- **IT_Orders:** (Process automation and case management) Ordering case using business process and case management assets. Places an IT hardware order based on needs and approvals.
- **Mortgages:** (Decision management with rules) Loan approval process using rule-based decision assets. Determines loan eligibility based on applicant data and qualifications.
- **Mortgage_Process:** (Process automation) Loan approval process using business process and decision assets. Determines loan eligibility based on applicant data and qualifications.
- **OptaCloud:** (Business optimization) Resource allocation optimization using decision and solver assets. Assigns processes to computers with limited resources.
- **Traffic_Violation:** (Decision management with DMN) Traffic violation decision service using a Decision Model and Notation (DMN) model. Determines driver penalty and suspension based on traffic violations.

1.1. ACCESSING SAMPLE PROJECTS AND BUSINESS ASSETS IN BUSINESS CENTRAL

You can use the sample projects in Business Central to explore business assets as a reference for the rules or other assets that you create in your own Red Hat Process Automation Manager projects.

Prerequisites

- Business Central is installed and running. For installation options, see [Planning a Red Hat Process Automation Manager installation](#).

Procedure

1. In Business Central, go to **Menu → Design → Projects**. If there are existing projects, you can access the samples by clicking on the **MySpace** default space and selecting **Try Samples** from the **Add Project** drop-down menu. If there are no existing projects, click **Try samples**.
2. Review the descriptions for each sample project to determine which project you want to explore. Each sample project is designed differently to demonstrate process automation, decision management, or business optimization assets and logic in Red Hat Process Automation Manager.
3. Select one or more sample projects and click **Ok** to add the projects to your space.
4. In the **Projects** page of your space, select one of the sample projects to view the assets for that project.
5. Select each asset to explore how the project is designed to achieve the specified goal or workflow. Some of the sample projects contain more than one page of assets. Click the left or right arrows in the upper-right corner to view the full asset list.

Figure 1.1. Asset page selection



6. In the upper-right corner of the project **Assets** page, click **Build** to build the sample project or **Deploy** to build the project and then deploy it to KIE Server.

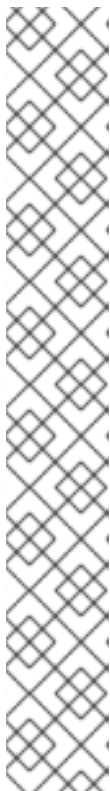

NOTE

You can also select the **Build & Install** option to build the project and publish the KJAR file to the configured Maven repository without deploying to a KIE Server. In a development environment, you can click **Deploy** to deploy the built KJAR file to a KIE Server without stopping any running instances (if applicable), or click **Redeploy** to deploy the built KJAR file and replace all instances. The next time you deploy or redeploy the built KJAR, the previous deployment unit (KIE container) is automatically updated in the same target KIE Server. In a production environment, the **Redeploy** option is disabled and you can click **Deploy** only to deploy the built KJAR file to a new deployment unit (KIE container) on a KIE Server.

To configure the KIE Server environment mode, set the **org.kie.server.mode** system property to **org.kie.server.mode=development** or **org.kie.server.mode=production**. To configure the deployment behavior for a corresponding project in Business Central, go to project **Settings → General Settings → Version**, toggle the **Development Mode** option, and click **Save**. By default, KIE Server and all new projects in Business Central are in development mode. You cannot deploy a project with **Development Mode** turned on or with a manually added **SNAPSHOT** version suffix to a KIE Server that is in production mode.

To review project deployment details, click **View deployment details** in the deployment banner at the top of the screen or in the **Deploy** drop-down menu. This option directs you to the **Menu → Deploy → Execution Servers** page.

CHAPTER 2. RED HAT PROCESS AUTOMATION MANAGER BPMN AND DMN MODELERS

Red Hat Process Automation Manager provides the following extensions or applications that you can use to design Business Process Model and Notation (BPMN) process models and Decision Model and Notation (DMN) decision models using graphical modelers.

- Business Central:** Enables you to view and design BPMN models, DMN models, and test scenario files in a related embedded designer.
To use Business Central, you can set up a development environment containing a Business Central to design business rules and processes, and a KIE Server to execute and test the created business rules and processes.
- Red Hat Process Automation Manager VSCode extension** Enables you to view and design BPMN models, DMN models, and test scenario files in Visual Studio Code (VSCode). The VSCode extension requires VSCode 1.46.0 or later.
To install the Red Hat Process Automation Manager VSCode extension, select the **Extensions** menu option in VSCode and search for and install the **Red Hat Business Automation Bundle** extension.
- Standalone BPMN and DMN editors** Enable you to view and design BPMN and DMN models embedded in your web applications. To download the necessary files, you can either use the NPM artifacts from the [NPM registry](#) or download the JavaScript files directly for the DMN standalone editor library at https://<YOUR_PAGE>/dmn/index.js and for the BPMN standalone editor library at https://<YOUR_PAGE>/bpmn/index.js.

2.1. INSTALLING THE RED HAT PROCESS AUTOMATION MANAGER VSCODE EXTENSION BUNDLE

Red Hat Process Automation Manager provides a **Red Hat Business Automation Bundle** VSCode extension that enables you to design Decision Model and Notation (DMN) decision models, Business Process Model and Notation (BPMN) 2.0 business processes, and test scenarios directly in VSCode. VSCode is the preferred integrated development environment (IDE) for developing new business applications. Red Hat Process Automation Manager also provides individual **DMN Editor** and **BPMN Editor** VSCode extensions for DMN or BPMN support only, if needed.

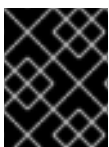

IMPORTANT

The editors in the VSCode are partially compatible with the editors in the Business Central, and several Business Central features are not supported in the VSCode.

Prerequisites

- The latest stable version of [VSCode](#) is installed.

Procedure

- In your VSCode IDE, select the **Extensions** menu option and search for **Red Hat Business Automation Bundle** for DMN, BPMN, and test scenario file support.
For DMN or BPMN file support only, you can also search for the individual **DMN Editor** or **BPMN Editor** extensions.
- When the **Red Hat Business Automation Bundle** extension appears in VSCode, select it and click **Install**.

3. For optimal VSCode editor behavior, after the extension installation is complete, reload or close and re-launch your instance of VSCode.

After you install the VSCode extension bundle, any **.dmn**, **.bpmn**, or **.bpmn2** files that you open or create in VSCode are automatically displayed as graphical models. Additionally, any **.scsim** files that you open or create are automatically displayed as tabular test scenario models for testing the functionality of your business decisions.

If the DMN, BPMN, or test scenario modelers open only the XML source of a DMN, BPMN, or test scenario file and displays an error message, review the reported errors and the model file to ensure that all elements are correctly defined.

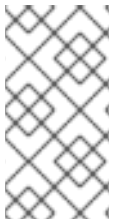

NOTE

For new DMN or BPMN models, you can also enter **dmn.new** or **bpmn.new** in a web browser to design your DMN or BPMN model in the online modeler. When you finish creating your model, you can click **Download** in the online modeler page to import your DMN or BPMN file into your Red Hat Process Automation Manager project in VSCode.

2.2. CONFIGURING THE RED HAT PROCESS AUTOMATION MANAGER STANDALONE EDITORS

Red Hat Process Automation Manager provides standalone editors that are distributed in a self-contained library providing an all-in-one JavaScript file for each editor. The JavaScript file uses a comprehensive API to set and control the editor.

You can install the standalone editors in three ways:

- Download each JavaScript file manually
- Use the NPM package

Procedure

1. Install the standalone editors using one of the following methods:

Download each JavaScript file manually For this method, follow these steps:

 - a. Download the JavaScript files.
 - b. Add the downloaded Javascript files to your hosted application.
 - c. Add the following **<script>** tag to your HTML page:

Script tag for your HTML page for the DMN editor

```
<script src="https://<YOUR_PAGE>/dmn/index.js"></script>
```

Script tag for your HTML page for the BPMN editor

```
<script src="https://<YOUR_PAGE>/bpmn/index.js"></script>
```

Use the NPM package: For this method, follow these steps:

- a. Add the NPM package to your **package.json** file:

Adding the NPM package

```
npm install @redhat/kogito-tooling-kie-editors-standalone
```

- b. Import each editor library to your TypeScript file:

Importing each editor

```
import * as DmnEditor from "@redhat/kogito-tooling-kie-editors-standalone/dist/dmn"
import * as BpmnEditor from "@redhat/kogito-tooling-kie-editors-standalone/dist/bpmn"
```

2. After you install the standalone editors, open the required editor by using the provided editor API, as shown in the following example for opening a DMN editor. The API is the same for each editor.

Opening the DMN standalone editor

```
const editor = DmnEditor.open({
  container: document.getElementById("dmn-editor-container"),
  initialContent: Promise.resolve(""),
  readOnly: false,
  origin: "",
  resources: new Map([
    [
      "MyIncludedModel.dmn",
      {
        contentType: "text",
        content: Promise.resolve("")
      }
    ]
  ])
});
```

Use the following parameters with the editor API:

Table 2.1. Example parameters

| Parameter | Description |
|-----------------------|---|
| container | HTML element in which the editor is appended. |
| initialContent | Promise to a DMN model content. This parameter can be empty, as shown in the following examples: <ul style="list-style-type: none"> ● <code>Promise.resolve("")</code> ● <code>Promise.resolve("<DIAGRAM_CONTENT_DIRECTLY_HERE>")</code> ● <code>fetch("MyDmnModel.dmn").then(content => content.text())</code> |

| Parameter | Description |
|-----------------------------|--|
| readOnly (Optional) | Enables you to allow changes in the editor. Set to false (default) to allow content editing and true for read-only mode in editor. |
| origin (Optional) | Origin of the repository. The default value is window.location.origin . |
| resources (Optional) | Map of resources for the editor. For example, this parameter is used to provide included models for the DMN editor or work item definitions for the BPMN editor. Each entry in the map contains a resource name and an object that consists of content-type (text or binary) and content (similar to the initialContent parameter). |

The returned object contains the methods that are required to manipulate the editor.

Table 2.2. Returned object methods

| Method | Description |
|--|--|
| getContent(): Promise<string> | Returns a promise containing the editor content. |
| setContent(content: string): void | Sets the content of the editor. |
| getPreview(): Promise<string> | Returns a promise containing an SVG string of the current diagram. |
| subscribeToContentChanges(callback: (isDirty: boolean) => void): (isDirty: boolean) => void | Sets a callback to be called when the content changes in the editor and returns the same callback to be used for unsubscription. |
| unsubscribeToContentChanges(callback: (isDirty: boolean) => void): void | Unsubscribes the passed callback when the content changes in the editor. |
| markAsSaved(): void | Resets the editor state that indicates that the content in the editor is saved. Also, it activates the subscribed callbacks related to content change. |
| undo(): void | Undoes the last change in the editor. Also, it activates the subscribed callbacks related to content change. |
| redo(): void | Redoes the last undone change in the editor. Also, it activates the subscribed callbacks related to content change. |

| Method | Description |
|--|--|
| close(): void | Closes the editor. |
| getElementPosition(selector: string): Promise<Rect> | Provides an alternative to extend the standard query selector when an element lives inside a canvas or a video component. The selector parameter must follow the <PROVIDER>::SELECT> format, such as Canvas::MySquare or Video::PresenterHand . This method returns a Rect representing the element position. |
| envelopeApi: MessageBusClientApi<KogitoEditorEnvelopeApi> | This is an advanced editor API. For more information about advanced editor API, see MessageBusClientApi and KogitoEditorEnvelopeApi . |

CHAPTER 3. CREATING AND EXECUTING DMN AND BPMN MODELS USING MAVEN

You can use Maven archetypes to develop DMN and BPMN models in VSCode using the Red Hat Process Automation Manager VSCode extension instead of Business Central. You can then integrate your archetypes with your Red Hat Process Automation Manager decision and process services in Business Central as needed. This method of developing DMN and BPMN models is helpful for building new business applications using the Red Hat Process Automation Manager VSCode extension.

Procedure

1. In a command terminal, navigate to a local folder where you want to store the new Red Hat Process Automation Manager project.
2. Enter the following command to generate a project within a defined folder using the following Maven archetype:

Generating a project using Maven archetype

```
mvn archetype:generate \  
-DarchetypeGroupId=org.kie \  
-DarchetypeArtifactId=kie-kjar-archetype \  
-DarchetypeVersion=7.52.0.Final-redhat-00007
```

This command generates a Maven project with required dependencies and generates required directories and files to build your business application. You can set up and use Git version-control system (recommended) when developing a project.

If you want to generate multiple projects in the same directory, you can specify the **artifactId** and **groupId** of the generated business application by adding **-DgroupId=<groupid> -DartifactId=<artifactId>** to the previous command.

3. In your VSCode IDE, click **File**, select **Open Folder**, and navigate to the folder that is generated using the previous command.
4. Before creating the first asset, set a package for your business application, for example, **org.kie.businessapp**, and create respective directories in the following paths:

- **PROJECT_HOME/src/main/java**
- **PROJECT_HOME/src/main/resources**
- **PROJECT_HOME/src/test/resources**

For example, you can create **PROJECT_HOME/src/main/java/org/kie/businessapp** for **org.kie.businessapp** package.

5. Use VSCode to create assets for your business application. You can create the assets supported by Red Hat Process Automation Manager VSCode extension using the following ways:
 - To create a business process, create a new file with **.bpmn** or **.bpmn2** in **PROJECT_HOME/src/main/java/org/kie/businessapp** directory, such as **Process.bpmn**.

- To create a DMN model, create a new file with **.dmn** in **PROJECT_HOME/src/main/java/org/kie/businessapp** directory, such as **AgeDecision.dmn**.
 - To create a test scenario simulation model, create a new file with **.scesim** in **PROJECT_HOME/src/main/java/org/kie/businessapp** directory, such as **TestAgeScenario.scesim**.
6. After you create the assets in your Maven archetype, navigate to the root directory (contains **pom.xml**) of the project in the command line and run the following command to build the knowledge JAR (KJAR) of your project:

```
mvn clean install
```

If the build fails, address any problems described in the command line error messages and try again to validate the project until the build is successful. However, if the build is successful, you can find the artifact of your business application in **PROJECT_HOME/target** directory.



NOTE

Use **mvn clean install** command often to validate your project after each major change during development.

You can deploy the generated knowledge JAR (KJAR) of your business application on a running KIE Server using the REST API. For more information about using REST API, see [Interacting with Red Hat Process Automation Manager using KIE APIs](#).

CHAPTER 4. CREATING THE TRAFFIC VIOLATIONS PROJECT IN BUSINESS CENTRAL

For this example, create a new project called **traffic-violation**. A project is a container for assets such as data objects, DMN assets, and test scenarios. This example project that you are creating is similar to the existing **Traffic_Violation** sample project in Business Central.

Procedure

1. In Business Central, go to **Menu → Design → Projects**.
Red Hat Process Automation Manager provides a default space called **MySpace**, as shown in the following image. You can use the default space to create and test example projects.

Figure 4.1. Default space



2. Click **Add Project**.
3. Enter **traffic-violation** in the **Name** field.
4. Click **Add**.

Figure 4.2. Add Project window

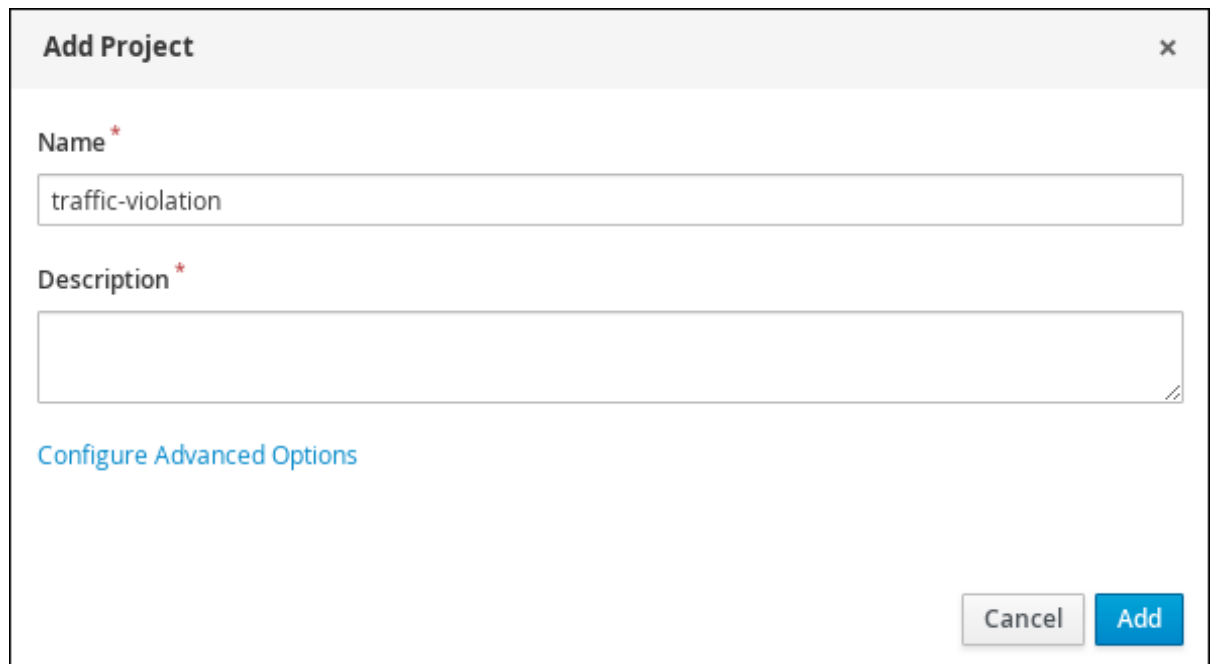
A screenshot of a modal dialog box titled 'Add Project' with a close button (x) in the top right corner. The dialog contains two text input fields. The first field is labeled 'Name *' and contains the text 'traffic-violation'. The second field is labeled 'Description *' and is currently empty. Below the description field is a blue link that says 'Configure Advanced Options'. At the bottom right of the dialog are two buttons: a grey 'Cancel' button and a blue 'Add' button.

The **Assets** view of the project opens.

CHAPTER 5. DECISION MODEL AND NOTATION (DMN)

Decision Model and Notation (DMN) is a standard established by the Object Management Group (OMG) for describing and modeling operational decisions. DMN defines an XML schema that enables DMN models to be shared between DMN-compliant platforms and across organizations so that business analysts and business rules developers can collaborate in designing and implementing DMN decision services. The DMN standard is similar to and can be used together with the Business Process Model and Notation (BPMN) standard for designing and modeling business processes.

For more information about the background and applications of DMN, see the [OMG Decision Model and Notation specification](#).

5.1. CREATING THE TRAFFIC VIOLATIONS DMN DECISION REQUIREMENTS DIAGRAM (DRD)

A decision requirements diagram (DRD) is a visual representation of your DMN model. Use the DMN designer in Business Central to design the DRD for the traffic violations project and to define the decision logic of the DRD components.

Figure 5.1. DRD for the Traffic Violations example

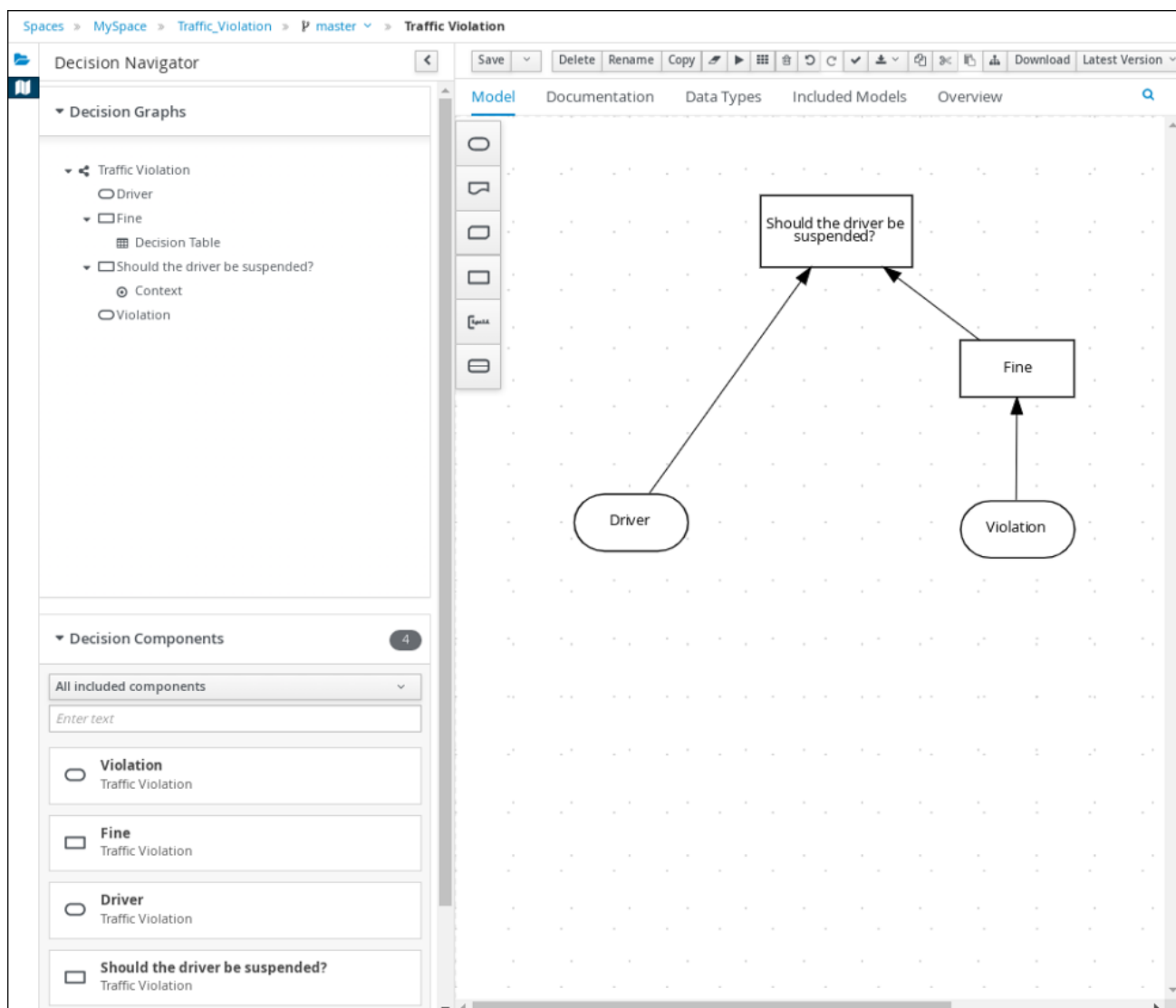

Prerequisites

- You have created the traffic violations project in Business Central.

Procedure

1. On the **traffic-violation** project's home page, click **Add Asset**.
2. On the **Add Asset** page, click **DMN**. The **Create new DMN** window is opened.
 - a. In the **Create new DMN** window, enter **Traffic Violation** in the **DMN name** field.
 - b. From the **Package** list, select **com.myspace.traffic_violation**.
 - c. Click **Ok**. The DMN asset in the DMN designer is opened.
3. In the DMN designer canvas, drag two **DMN Input Data** input nodes onto the canvas.

Figure 5.2. DMN Input Data nodes

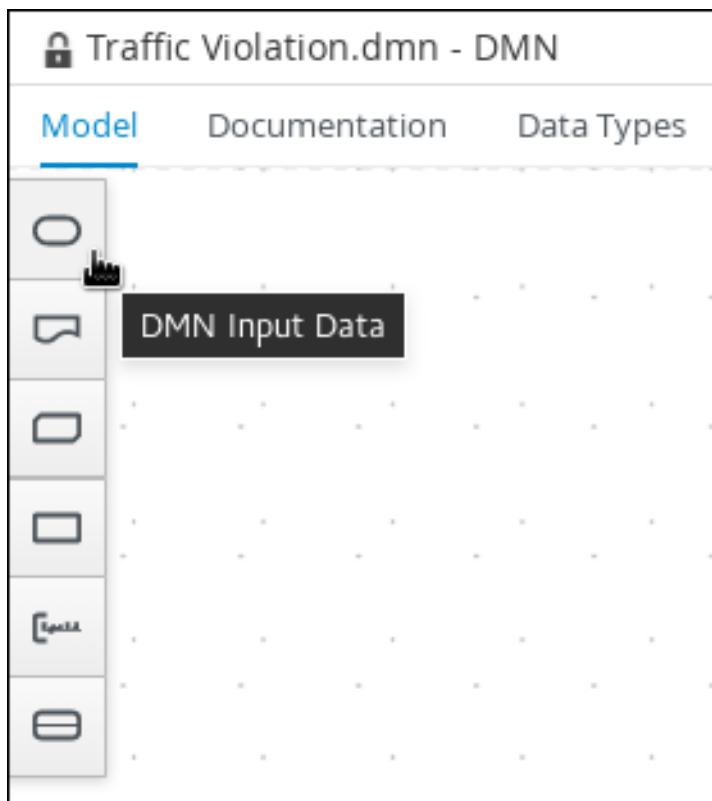

4. In the upper-right corner, click the  icon.
5. Double-click the input nodes and rename one to **Driver** and the other to **Violation**.
6. Drag a **DMN Decision** decision node onto the canvas.
7. Double-click the decision node and rename it to **Fine**.
8. Click the **Violation** input node, select the **Create DMN Information Requirement** icon and click the **Fine** decision node to link the two nodes.

Figure 5.3. Create DMN Information Requirement icon



9. Drag a **DMN Decision** decision node onto the canvas.
10. Double-click the decision node and rename it to **Should the driver be suspended?**
11. Click the **Driver** input node, select the **Create DMN Information Requirement** icon and click the **Should the driver be suspended?** decision node to link the two nodes.
12. Click the **Fine** decision node, select the **Create DMN Information Requirement** icon, and select the **Should the driver be suspended?** decision node.
13. Click **Save**.

**NOTE**

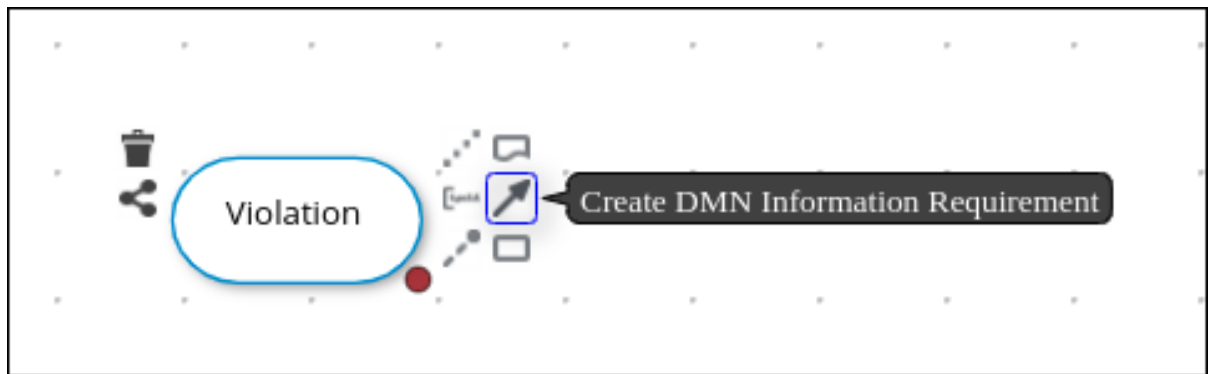
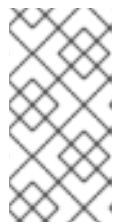
As you periodically save a DRD, the DMN designer performs a static validation of the DMN model and might produce error messages until the model is defined completely. After you finish defining the DMN model completely, if any errors remain, troubleshoot the specified problems accordingly.

5.2. CREATING THE TRAFFIC VIOLATIONS DMN CUSTOM DATA TYPES

DMN data types determine the structure of the data that you use within a table, column, or field in a DMN boxed expression for defining decision logic. You can use default DMN data types (such as string, number, or boolean) or you can create custom data types to specify additional fields and constraints that you want to implement for the boxed expression values. Use the DMN designer's **Data Types** tab in Business Central to define the custom data types for the traffic violations project.

Figure 5.4. The custom data types tab

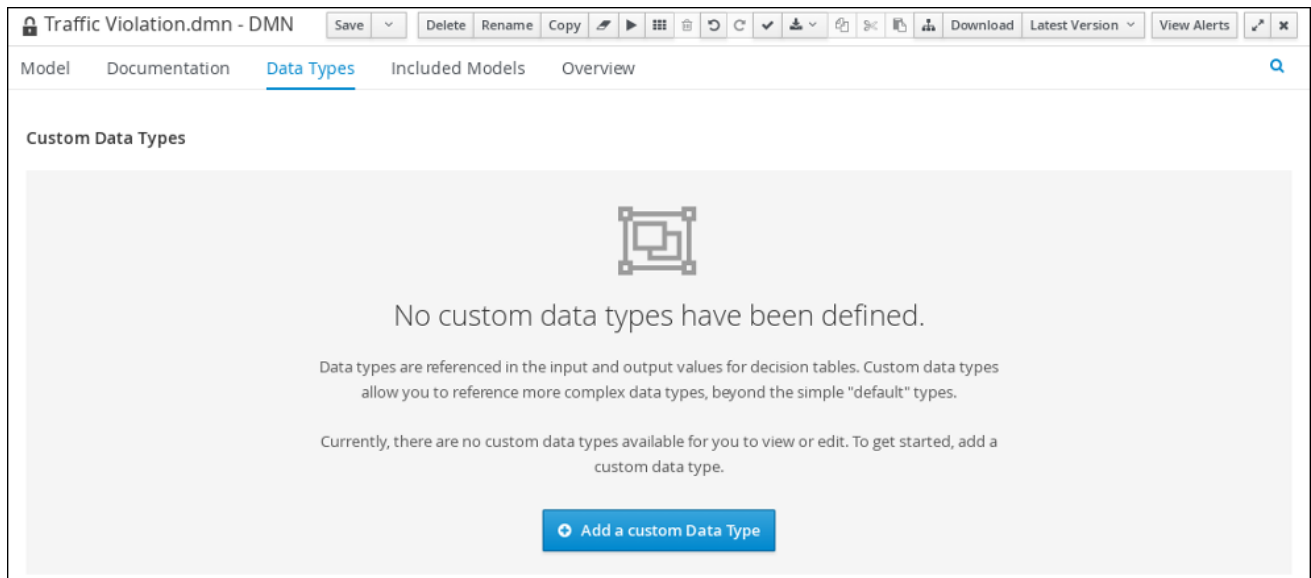

The following tables list the **tDriver**, **tViolation**, and **tFine** custom data types that you will create for this project.

Table 5.1. **tDriver** custom data type

| Name | Type |
|---------|-----------|
| tDriver | Structure |
| Name | string |
| Age | number |
| State | string |
| City | string |
| Points | number |

Table 5.2. **tViolation** custom data type

| Name | Type |
|-------------|-----------|
| tViolation | Structure |
| Code | string |
| Date | date |
| Type | string |
| Speed Limit | number |

| Name | Type |
|--------------|--------|
| Actual Speed | number |

Table 5.3. tFine custom data type

| Name | Type |
|--------|-----------|
| tFine | Structure |
| Amount | number |
| Points | number |

Prerequisites

- You created the traffic violations DMN decision requirements diagram (DRDs) in Business Central.

Procedure

- To create the **tDriver** custom data type, click **Add a custom Data Type** on the **Data Types** tab, enter **tDriver** in the **Name** field, and select **Structure** from the **Type** list.
- Click the check mark to the right of the new data type to save your changes.

Figure 5.5. The tDriver custom data type

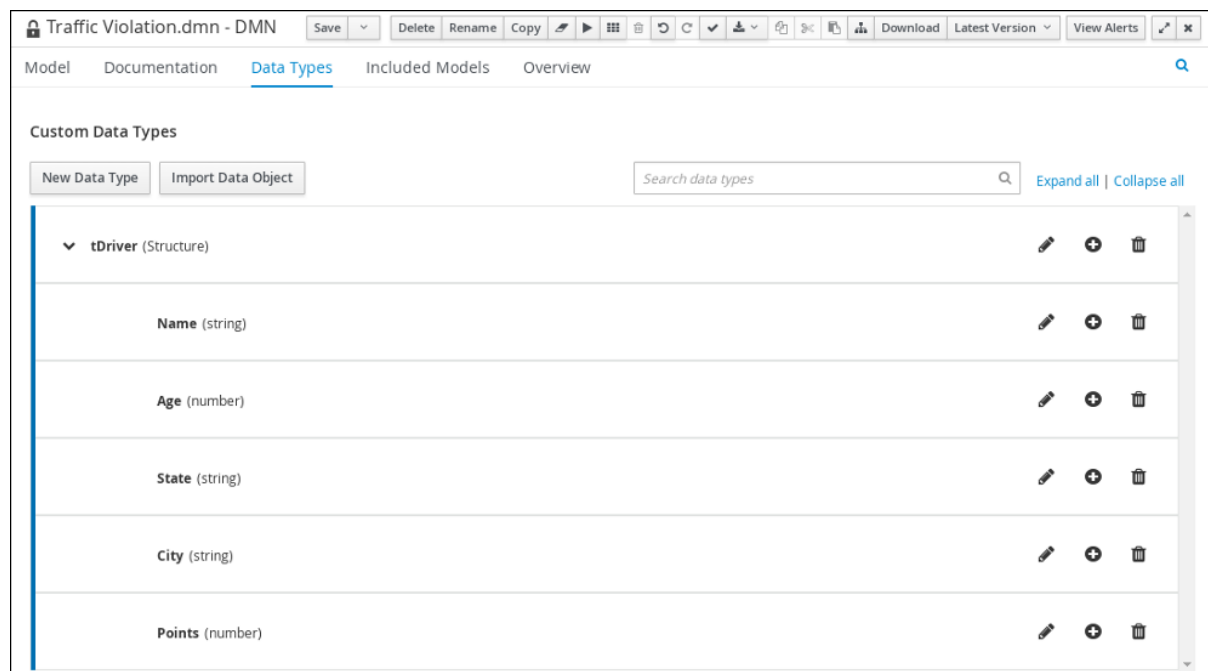

- Add each of the following nested data types to the **tDriver** structured data type by clicking the plus sign next to **tDriver** for each new nested data type. Click the check mark to the right of each new data type to save your changes.
 - Name** (string)

- **Age** (number)
 - **State** (string)
 - **City** (string)
 - **Points** (number)
4. To create the **tViolation** custom data type, click **New Data Type**, enter **tViolation** in the **Name** field, and select **Structure** from the **Type** list.
 5. Click the check mark to the right of the new data type to save your changes.

Figure 5.6. The **tViolation** custom data type

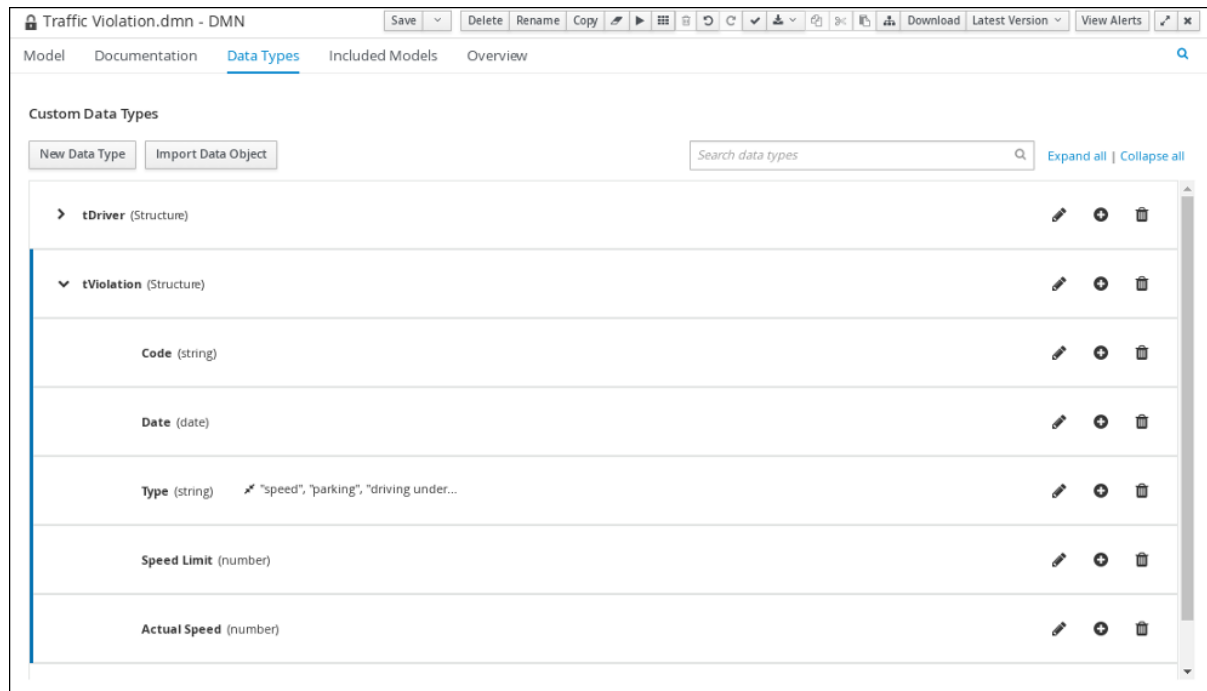

6. Add each of the following nested data types to the **tViolation** structured data type by clicking the plus sign next to **tViolation** for each new nested data type. Click the check mark to the right of each new data type to save your changes.
 - **Code** (string)
 - **Date** (date)
 - **Type** (string)
 - **Speed Limit** (number)
 - **Actual Speed** (number)
7. To add the following constraints to the **Type** nested data type, click the edit icon, click **Add Constraints**, and select **Enumeration** from the **Select constraint type** drop-down menu.
 - **speed**
 - **parking**
 - **driving under the influence**

8. Click **OK**, then click the check mark to the right of the **Type** data type to save your changes.
9. To create the **tFine** custom data type, click **New Data Type**, enter **tFine** in the **Name** field, select **Structure** from the **Type** list, and click **Save**.

Figure 5.7. The tFine custom data type

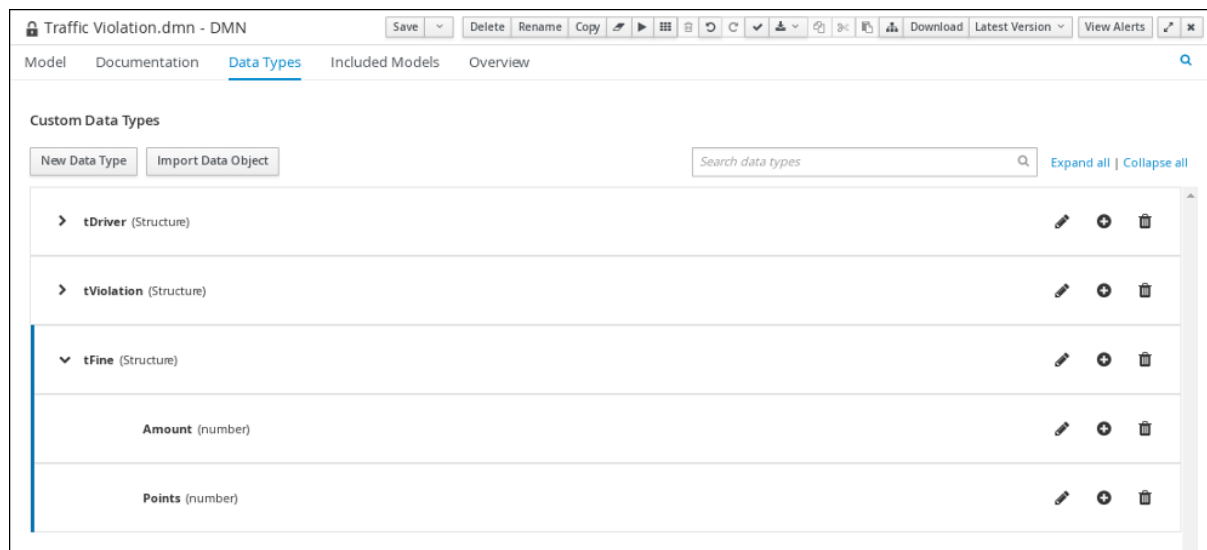

10. Add each of the following nested data types to the **tFine** structured data type by clicking the plus sign next to **tFine** for each new nested data type. Click the check mark to the right of each new data type to save your changes.
 - **Amount** (number)
 - **Points** (number)
11. Click **Save**.

5.3. ASSIGNING CUSTOM DATA TYPES TO THE DRD INPUT AND DECISION NODES

After you create the DMN custom data types, assign them to the appropriate **DMN Input Data** and **DMN Decision** nodes in the traffic violations DRD.

Prerequisites

- You have created the traffic violations DMN custom data types in Business Central.

Procedure

1. Click the **Model** tab on the DMN designer and click the **Properties**  icon in the upper-right corner of the DMN designer to expose the DRD properties.
2. In the DRD, select the **Driver** input data node and in the **Properties** panel, select **tDriver** from the **Data type** drop-down menu.
3. Select the **Violation** input data node and select **tViolation** from the **Data type** drop-down menu.
4. Select the **Fine** decision node and select **tFine** from the **Data type** drop-down menu.

5. Select the **Should the driver be suspended?** decision node and set the following properties:

- **Data type:** string
- **Question:** **Should the driver be suspended due to points on his driver license?**
- **Allowed Answers:** Yes,No

6. Click **Save**.

You have assigned the custom data types to your DRD's input and decision nodes.

5.4. DEFINING THE TRAFFIC VIOLATIONS DMN DECISION LOGIC

To calculate the fine and to decide whether the driver is to be suspended or not, you can define the traffic violations DMN decision logic using a DMN decision table and context boxed expression.

Figure 5.8. Fine expression

| U | Violation.Type (string) | Violation.Actual Speed - Violation.Speed Limit (number) | Fine (tFine) | | Enter Text |
|---|-------------------------------|--|--------------------|--------------------|------------|
| | | | Amount (number) | Points (number) | |
| 1 | "speed" | [10..30) | 500 | 3 | |
| 2 | "speed" | >= 30 | 1000 | 7 | |
| 3 | "parking" | - | 100 | 1 | |
| 4 | "driving under the influence" | - | 1000 | 5 | |

Figure 5.9. Should the driver be suspended expression

| # | Should the driver be suspended? (string) | |
|---|---|--|
| 1 | Total Points (number) | Driver.Points + Fine.Points |
| | <result> | if Total Points >= 20 then "Yes" else "No" |

Prerequisites

- You have assigned the DMN custom data types to the appropriate decision and input nodes in the traffic violations DRD in Business Central.

Procedure

1. To calculate the fine, in the DMN designer canvas, select the **Fine** decision node and click the **Edit** icon to open the DMN boxed expression designer.

Figure 5.10. Decision node edit icon

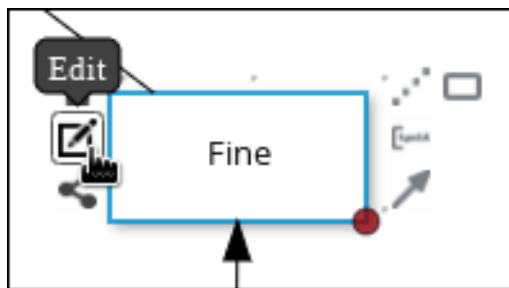

2. Click **Select expression** → **Decision Table**.

Figure 5.11. Select Decisioning Table logic type

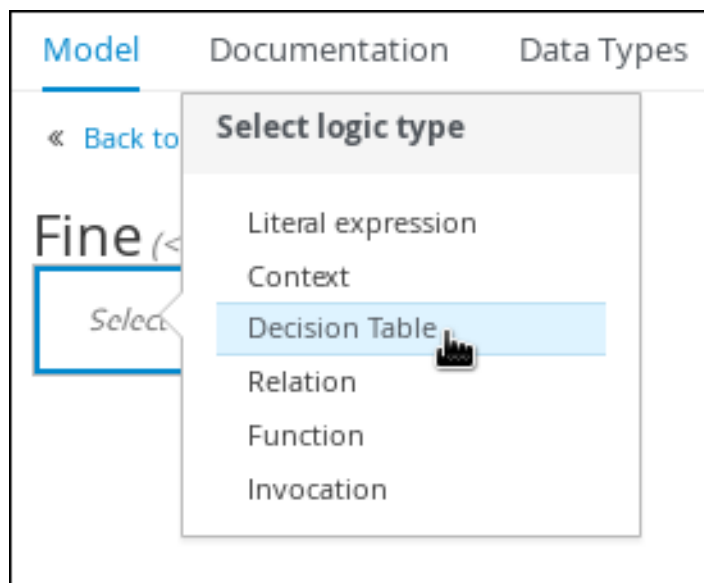

3. For the **Violation.Date**, **Violation.Code**, and **Violation.Speed Limit** columns, right-click and select **Delete** for each field.
4. Click the **Violation.Actual Speed** column header and enter the expression **Violation.Actual Speed - Violation.Speed Limit** in the **Expression** field."
5. Enter the following values in the first row of the decision table:
 - **Violation.Type: "speed"**
 - **Violation.Actual Speed - Violation.Speed Limit [10..30)**
 - **Amount: 500**
 - **Points: 3**
 Right-click the first row and select **Insert below** to add another row.
6. Enter the following values in the second row of the decision table:
 - **Violation.Type: "speed"**
 - **Violation.Actual Speed - Violation.Speed Limit >= 30**

- **Amount: 1000**
 - **Points: 7**
Right-click the second row and select **Insert below** to add another row.
7. Enter the following values in the third row of the decision table:
- **Violation.Type: "parking"**
 - **Violation.Actual Speed - Violation.Speed Limit -**
 - **Amount: 100**
 - **Points: 1**
Right-click the third row and select **Insert below** to add another row.
8. Enter the following values in the fourth row of the decision table:
- **Violation.Type: "driving under the influence"**
 - **Violation.Actual Speed - Violation.Speed Limit -**
 - **Amount: 1000**
 - **Points: 5**
9. Click **Save**.
10. To define the driver suspension rule, return to the DMN designer canvas, select the **Should the driver be suspended?** decision node, and click the **Edit** icon to open the DMN boxed expression designer.
11. Click **Select expression → Context**.
12. Click **ContextEntry-1**, enter **Total Points** as the **Name**, and select **number** from the **Data Type** drop-down menu.
13. Click the cell next to **Total Points**, select **Literal expression** from the context menu, and enter **Driver.Points + Fine.Points** as the expression.
14. In the cell below **Driver.Points + Fine.Points**, select **Literal Expression** from the context menu, and enter **if Total Points >= 20 then "Yes" else "No"**.
15. Click **Save**.
You have defined how to calculate the fine and the context for deciding when to suspend the driver. You can navigate to the **traffic-violation** project page and click **Build** to build the example project and address any errors noted in the **Alerts** panel.

CHAPTER 6. TEST SCENARIOS

Test scenarios in Red Hat Process Automation Manager enable you to validate the functionality of business rules and business rule data (for rules-based test scenarios) or of DMN models (for DMN-based test scenarios) before deploying them into a production environment. With a test scenario, you use data from your project to set given conditions and expected results based on one or more defined business rules. When you run the scenario, the expected results and actual results of the rule instance are compared. If the expected results match the actual results, the test is successful. If the expected results do not match the actual results, then the test fails.

Red Hat Process Automation Manager includes both the new **Test Scenarios** designer and the former **Test Scenarios (Legacy)** designer. The default designer is the new test scenarios designer, which supports the testing of both rules and DMN models and provides an enhanced overall user experience with test scenarios. If required, you can continue to use the legacy test scenarios designer, which supports rule-based test scenarios only.

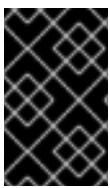

IMPORTANT

The legacy test scenarios designer is deprecated from Red Hat Process Automation Manager version 7.3.0. It will be removed in a future Red Hat Process Automation Manager release. Use the new test scenarios designer instead.

You can run the defined test scenarios in a number of ways, for example, you can run available test scenarios at the project level or inside a specific test scenario asset. Test scenarios are independent and cannot affect or modify other test scenarios. You can run test scenarios at any time during project development in Business Central. You do not have to compile or deploy your decision service to run test scenarios.

You can import data objects from different packages to the same project package as the test scenario. Assets in the same package are imported by default. After you create the necessary data objects and the test scenario, you can use the **Data Objects** tab of the test scenarios designer to verify that all required data objects are listed or to import other existing data objects by adding a **New item**.

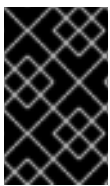

IMPORTANT

Throughout the test scenarios documentation, all references to *test scenarios* and the *test scenarios designer* are for the new version, unless explicitly noted as the legacy version.

6.1. TESTING THE TRAFFIC VIOLATIONS USING TEST SCENARIOS

Use the test scenarios designer in Business Central to test the DMN decision requirements diagrams (DRDs) and define decision logic for the traffic violations project.

Figure 6.1. Test scenario for the traffic violations example

| # | Scenario description | GIVEN | | | | EXPECT | | |
|---|---------------------------------------|--------|-------------------------------|---------------------|---------------------|--------|--------|---------------------------------|
| | | Driver | Violation | | | Fine | | Should the driver be suspended? |
| | | Points | Type | Speed Limit | Actual Speed | Points | Amount | value |
| 1 | Above speed limit: 10km/h and 30 km/h | 10 | "speed" | 100 | 120 | 3 | 500 | "No" |
| 2 | Above speed limit: more than 30 km/h | 10 | "speed" | 100 | 150 | 7 | 1000 | "No" |
| 3 | Parking violation | 10 | "parking" | <i>Insert value</i> | <i>Insert value</i> | 1 | 100 | "No" |
| 4 | DUI violation | 10 | "driving under the influence" | <i>Insert value</i> | <i>Insert value</i> | 5 | 1000 | "No" |
| 5 | Driver suspended | 15 | "speed" | 100 | 140 | 7 | 1000 | "Yes" |

Prerequisites

- You have successfully built the traffic violations project in Business Central.

Procedure

1. On the **traffic-violation** project's home screen, click **Add Asset** to open the **Add Asset** screen.
2. Click **Test Scenario** to open the **Create new Test Scenario** dialog.
 - a. Enter **Violation Scenarios** in the **Test Scenario** field.
 - b. From the **Package** list, select **com.myspace.traffic_violation**.
 - c. Select **DMN** as the **Source type**.
 - d. From the **Choose a DMN asset** list, select the path to the DMN asset.
 - e. Click **Ok** to open the **Violation Scenarios** test scenario in the **Test Scenarios** designer.
3. Under **Driver** column sub-header, right-click the **State**, **City**, **Age**, and **Name** value cells and select **Delete column** from the context menu options to remove them.
4. Under **Violation** column sub-header, right-click the **Date** and **Code** value cells and select **Delete column** to remove them.
5. Enter the following information in the first row of the test scenarios:
 - **Scenario description: Above speed limit: 10km/h and 30 km/h**
 - **Points** (under **Given** column header): **10**
 - **Type: "speed"**
 - **Speed Limit: 100**
 - **Actual Speed: 120**
 - **Points: 3**
 - **Amount: 500**
 - **Should the driver be suspended?: "No"**
Right-click the first row and select **Insert row below** to add another row.
6. Enter the following information in the second row of the test scenarios:
 - **Scenario description: Above speed limit: more than 30 km/h**
 - **Points** (under **Given** column header): **10**
 - **Type: "speed"**
 - **Speed Limit: 100**
 - **Actual Speed: 150**
 - **Points: 7**

- **Amount: 1000**
 - **Should the driver be suspended? "No"**
Right-click the second row and select **Insert row below** to add another row.
7. Enter the following information in the third row of the test scenarios:
- **Scenario description: Parking violation**
 - **Points** (under **Given** column header): **10**
 - **Type: "parking"**
 - **Speed Limit:** leave blank
 - **Actual Speed:** leave blank
 - **Points: 1**
 - **Amount: 100**
 - **Should the driver be suspended? "No"**
Right-click the third row and select **Insert row below** to add another row.
8. Enter the following information in the fourth row of the test scenarios:
- **Scenario description: DUI violation**
 - **Points** (under **Given** column header): **10**
 - **Type: "driving under the influence"**
 - **Speed Limit:** leave blank
 - **Actual Speed:** leave blank
 - **Points: 5**
 - **Amount: 1000**
 - **Should the driver be suspended? "No"**
Right-click the fourth row and select **Insert row below** to add another row.
9. Enter the following information in the fifth row of the test scenarios:
- **Scenario description: Driver suspended**
 - **Points** (under **Given** column header): **15**
 - **Type: "speed"**
 - **Speed Limit: 100**
 - **Actual Speed: 140**
 - **Points: 7**
 - **Amount: 1000**

- Should the driver be suspended?. "Yes"

10. Click **Save**.

11. Click the **Play** icon  to check whether the test scenarios pass or fail.

Figure 6.2. Test scenario execution result for the traffic violations example



| # | Scenario description | GIVEN | | | | | Fine | |
|---|---------------------------------------|--------|----------------------|---------------------|---------------------|--------|------|--|
| | | Driver | Violation | | | Points | | |
| | | Points | Type | Speed Limit | ActualSpeed | Points | | |
| 1 | Above speed limit: 10km/h and 30 km/h | 10 | "speed" | 100 | 120 | 3 | | |
| 2 | Above speed limit: more than 30 km/h | 10 | "speed" | 100 | 150 | 7 | | |
| 3 | Parking violation | 10 | "parking" | <i>Insert value</i> | <i>Insert value</i> | 1 | | |
| 4 | DUI violation | 10 | ing under the influe | <i>Insert value</i> | <i>Insert value</i> | 5 | | |
| 5 | Driver suspended | 15 | "speed" | 100 | 140 | 7 | | |

Test Report

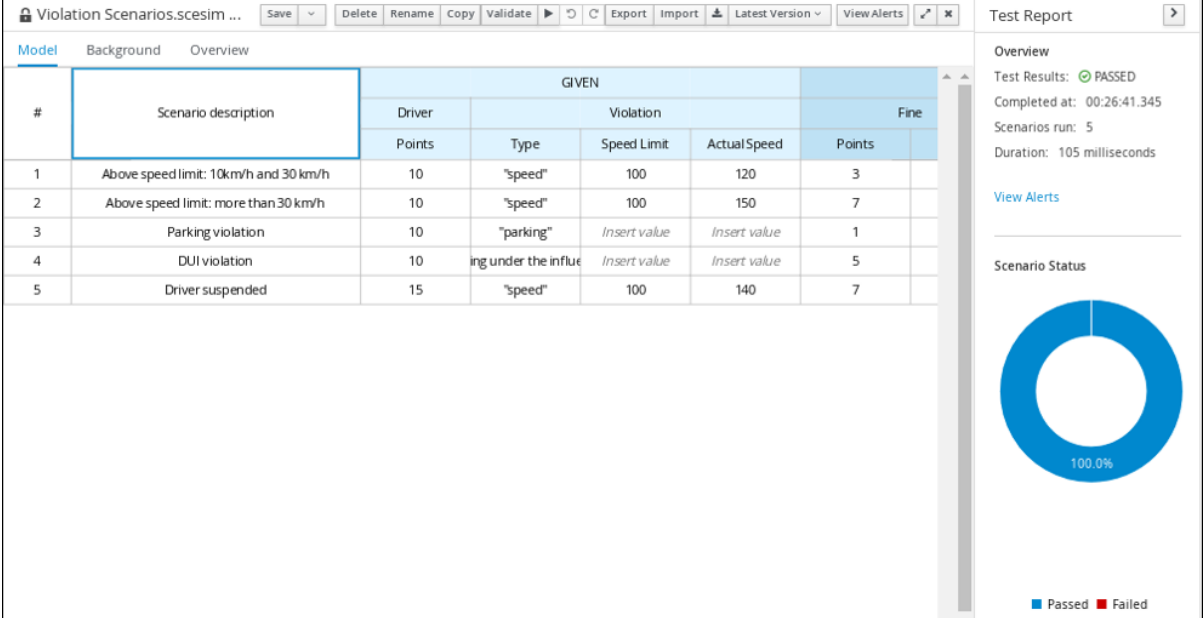
Overview
 Test Results: ✔ PASSED
 Completed at: 00:26:41.345
 Scenarios run: 5
 Duration: 105 milliseconds

[View Alerts](#)

Scenario Status

100.0%

■ Passed ■ Failed

In case of failure, correct the errors and run the test scenarios again.

CHAPTER 7. DMN MODEL EXECUTION

You can create or import DMN files in your Red Hat Process Automation Manager project using Business Central or package the DMN files as part of your project knowledge JAR (KJAR) file without Business Central. After you implement your DMN files in your Red Hat Process Automation Manager project, you can execute the DMN decision service by deploying the KIE container that contains it to KIE Server for remote access and interacting with the container using the KIE Server REST API.

For information about including external DMN assets with your project packaging and deployment method, see [Packaging and deploying a Red Hat Process Automation Manager project](#) .

7.1. EXECUTING A DMN SERVICE USING THE KIE SERVER REST API

Directly interacting with the REST endpoints of KIE Server provides the most separation between the calling code and the decision logic definition. The calling code is completely free of direct dependencies, and you can implement it in an entirely different development platform such as **Node.js** or **.NET**. The examples in this section demonstrate Nix-style curl commands but provide relevant information to adapt to any REST client.

When you use a REST endpoint of KIE Server, the best practice is to define a domain object POJO Java class, annotated with standard KIE Server marshalling annotations. For example, the following code is using a domain object **Person** class that is annotated properly:

Example POJO Java class

```
@javax.xml.bind.annotation.XmlAccessorType(javax.xml.bind.annotation.XmlAccessType.FIELD)
public class Person implements java.io.Serializable {

    static final long serialVersionUID = 1L;

    private java.lang.String id;
    private java.lang.String name;

    @javax.xml.bind.annotation.adapters.XmlJavaTypeAdapter(org.kie.internal.jaxb.LocalDateXmlAdapter.c
lass)
    private java.time.LocalDate dojoining;

    public Person() {
    }

    public java.lang.String getId() {
        return this.id;
    }

    public void setId(java.lang.String id) {
        this.id = id;
    }

    public java.lang.String getName() {
        return this.name;
    }

    public void setName(java.lang.String name) {
        this.name = name;
    }
}
```

```

public java.time.LocalDate getDojoining() {
    return this.dojoining;
}

public void setDojoining(java.time.LocalDate dojoining) {
    this.dojoining = dojoining;
}

public Person(java.lang.String id, java.lang.String name,
    java.time.LocalDate dojoining) {
    this.id = id;
    this.name = name;
    this.dojoining = dojoining;
}
}

```

For more information about the KIE Server REST API, see [Interacting with Red Hat Process Automation Manager using KIE APIs](#).

Prerequisites

- KIE Server is installed and configured, including a known user name and credentials for a user with the **kie-server** role. For installation options, see [Planning a Red Hat Process Automation Manager installation](#).
- You have built the DMN project as a KJAR artifact and deployed it to KIE Server. Ideally, you have built the DMN project as an executable model for more efficient execution:

```
mvn clean install -DgenerateDMNModel=yes
```

For more information about project packaging and deployment and executable models, see [Packaging and deploying a Red Hat Process Automation Manager project](#).

- You have the ID of the KIE container containing the DMN model. If more than one model is present, you must also know the model namespace and model name of the relevant model.

Procedure

1. Determine the base URL for accessing the KIE Server REST API endpoints. This requires knowing the following values (with the default local deployment values as an example):
 - Host (**localhost**)
 - Port (**8080**)
 - Root context (**kie-server**)
 - Base REST path (**services/rest/**)

Example base URL in local deployment for the traffic violations project:

http://localhost:8080/kie-server/services/rest/server/containers/traffic-violation_1.0.0-SNAPSHOT

- Determine user authentication requirements.

When users are defined directly in the KIE Server configuration, HTTP Basic authentication is used and requires the user name and password. Successful requests require that the user have the **kie-server** role.

The following example demonstrates how to add credentials to a curl request:

```
curl -u username:password <request>
```

If KIE Server is configured with Red Hat Single Sign-On, the request must include a bearer token:

```
curl -H "Authorization: bearer $TOKEN" <request>
```

- Specify the format of the request and response. The REST API endpoints work with both JSON and XML formats and are set using request headers:

JSON

```
curl -H "accept: application/json" -H "content-type: application/json"
```

XML

```
curl -H "accept: application/xml" -H "content-type: application/xml"
```

- Optional: Query the container for a list of deployed decision models:

[GET] server/containers/{containerId}/dmn

Example curl request:

```
curl -u wbadm:wbadm -H "accept: application/xml" -X GET "http://localhost:8080/kie-server/services/rest/server/containers/traffic-violation_1.0.0-SNAPSHOT/dmn"
```

Sample XML output:

```
<?xml version="1.0" encoding="UTF-8" standalone="yes"?>
<response type="SUCCESS" msg="Ok models successfully retrieved from container 'traffic-violation_1.0.0-SNAPSHOT'">
  <dmn-model-info-list>
    <model>
      <model-namespace>https://github.com/kiegroup/drools/kie-dmn/_60b01f4d-e407-43f7-848e-258723b5fac8</model-namespace>
      <model-name>Traffic Violation</model-name>
      <model-id>_2CD7D1AA-BD84-4B43-AD21-B0342ADE655A</model-id>
      <decisions>
        <dmn-decision-info>
          <decision-id>_23428EE8-DC8B-4067-8E67-9D7C53EC975F</decision-id>
          <decision-name>Fine</decision-name>
        </dmn-decision-info>
        <dmn-decision-info>
          <decision-id>_B5EEE2B1-915C-44DC-BE43-C244DC066FD8</decision-id>
          <decision-name>Should the driver be suspended?</decision-name>
        </dmn-decision-info>
      </decisions>
    </model>
  </dmn-model-info-list>
</response>
```

```

</decisions>
<inputs>
  <dmn-inputdata-info>
    <inputdata-id>_CEB959CD-3638-4A87-93BA-03CD0FB63AE3</inputdata-id>
    <inputdata-name>Violation</inputdata-name>
    <inputdata-typeref>
      <namespace-uri>https://github.com/kiegroup/drools/kie-dmn/_60B01F4D-
E407-43F7-848E-258723B5FAC8</namespace-uri>
      <local-part>tViolation</local-part>
      <prefix></prefix>
    </inputdata-typeref>
  </dmn-inputdata-info>
  <dmn-inputdata-info>
    <inputdata-id>_B0E810E6-7596-430A-B5CF-67CE16863B6C</inputdata-id>
    <inputdata-name>Driver</inputdata-name>
    <inputdata-typeref>
      <namespace-uri>https://github.com/kiegroup/drools/kie-dmn/_60B01F4D-
E407-43F7-848E-258723B5FAC8</namespace-uri>
      <local-part>tDriver</local-part>
      <prefix></prefix>
    </inputdata-typeref>
  </dmn-inputdata-info>
</inputs>
<itemdefinitions>
  <dmn-itemdefinition-info>
    <itemdefinition-id>_9C758F4A-7D72-4D0F-B63F-
2F5B8405980E</itemdefinition-id>
    <itemdefinition-name>tViolation</itemdefinition-name>
    <itemdefinition-itemcomponent>
      <dmn-itemdefinition-info>
        <itemdefinition-id>_0B6FF1E2-ACE9-4FB3-876B-
5BB30B88009B</itemdefinition-id>
        <itemdefinition-name>Code</itemdefinition-name>
        <itemdefinition-typeref>
          <namespace-uri>https://github.com/kiegroup/drools/kie-dmn/_60b01f4d-
e407-43f7-848e-258723b5fac8</namespace-uri>
          <local-part>string</local-part>
          <prefix></prefix>
        </itemdefinition-typeref>
        <itemdefinition-itemcomponent/>
        <itemdefinition-iscollection>>false</itemdefinition-iscollection>
      </dmn-itemdefinition-info>
      <dmn-itemdefinition-info>
        <itemdefinition-id>_27A5DA18-3CA7-4C06-81B7-
CF7F2F050E29</itemdefinition-id>
        <itemdefinition-name>date</itemdefinition-name>
        <itemdefinition-typeref>
          <namespace-uri>https://github.com/kiegroup/drools/kie-dmn/_60B01F4D-
E407-43F7-848E-258723B5FAC8</namespace-uri>
          <local-part>date</local-part>
          <prefix></prefix>
        </itemdefinition-typeref>
        <itemdefinition-itemcomponent/>
        <itemdefinition-iscollection>>false</itemdefinition-iscollection>
      </dmn-itemdefinition-info>
    </dmn-itemdefinition-info>
  </dmn-itemdefinition-info>

```



```

        <itemdefinition-id>_8961969A-8A80-4F12-B568-
346920C0F038</itemdefinition-id>
        <itemdefinition-name>type</itemdefinition-name>
        <itemdefinition-typeref>
            <namespace-uri>https://github.com/kiegroup/drools/kie-dmn/_60B01F4D-
E407-43F7-848E-258723B5FAC8</namespace-uri>
            <local-part>string</local-part>
            <prefix></prefix>
        </itemdefinition-typeref>
        <itemdefinition-itemcomponent/>
        <itemdefinition-iscollection>>false</itemdefinition-iscollection>
    </dmn-itemdefinition-info>
    <dmn-itemdefinition-info>
        <itemdefinition-id>_7450F12A-3E95-4D5E-8DCE-
2CB1FAC2BDD4</itemdefinition-id>
        <itemdefinition-name>speed limit</itemdefinition-name>
        <itemdefinition-typeref>
            <namespace-uri>https://github.com/kiegroup/drools/kie-dmn/_60b01f4d-
e407-43f7-848e-258723b5fac8</namespace-uri>
            <local-part>number</local-part>
            <prefix></prefix>
        </itemdefinition-typeref>
        <itemdefinition-itemcomponent/>
        <itemdefinition-iscollection>>false</itemdefinition-iscollection>
    </dmn-itemdefinition-info>
    <dmn-itemdefinition-info>
        <itemdefinition-id>_0A9A6F26-6C14-414D-A9BF-
765E5850429A</itemdefinition-id>
        <itemdefinition-name>Actual Speed</itemdefinition-name>
        <itemdefinition-typeref>
            <namespace-uri>https://github.com/kiegroup/drools/kie-dmn/_60B01F4D-
E407-43F7-848E-258723B5FAC8</namespace-uri>
            <local-part>number</local-part>
            <prefix></prefix>
        </itemdefinition-typeref>
        <itemdefinition-itemcomponent/>
        <itemdefinition-iscollection>>false</itemdefinition-iscollection>
    </dmn-itemdefinition-info>
    </itemdefinition-itemcomponent>
    <itemdefinition-iscollection>>false</itemdefinition-iscollection>
</dmn-itemdefinition-info>
<dmn-itemdefinition-info>
    <itemdefinition-id>_13C7EFD8-B85C-43BF-94D3-
14FABE39A4A0</itemdefinition-id>
    <itemdefinition-name>tDriver</itemdefinition-name>
    <itemdefinition-itemcomponent>
        <dmn-itemdefinition-info>
            <itemdefinition-id>_EC11744C-4160-4549-9610-
2C757F40DFE8</itemdefinition-id>
            <itemdefinition-name>Name</itemdefinition-name>
            <itemdefinition-typeref>
                <namespace-uri>https://github.com/kiegroup/drools/kie-dmn/_60B01F4D-
E407-43F7-848E-258723B5FAC8</namespace-uri>
                <local-part>string</local-part>
                <prefix></prefix>
            </itemdefinition-typeref>

```

```

        <itemdefinition-itemcomponent/>
        <itemdefinition-iscollection>>false</itemdefinition-iscollection>
    </dmn-itemdefinition-info>
    <dmn-itemdefinition-info>
        <itemdefinition-id>_E95BE3DB-4A51-4658-A166-
02493EAAC9D2</itemdefinition-id>
        <itemdefinition-name>Age</itemdefinition-name>
        <itemdefinition-typeref>
            <namespace-uri>https://github.com/kiegroup/drools/kie-dmn/_60B01F4D-
E407-43F7-848E-258723B5FAC8</namespace-uri>
            <local-part>number</local-part>
            <prefix></prefix>
        </itemdefinition-typeref>
        <itemdefinition-itemcomponent/>
        <itemdefinition-iscollection>>false</itemdefinition-iscollection>
    </dmn-itemdefinition-info>
    <dmn-itemdefinition-info>
        <itemdefinition-id>_7B3023E2-BC44-4BF3-BF7E-
773C240FB9AD</itemdefinition-id>
        <itemdefinition-name>State</itemdefinition-name>
        <itemdefinition-typeref>
            <namespace-uri>https://github.com/kiegroup/drools/kie-dmn/_60B01F4D-
E407-43F7-848E-258723B5FAC8</namespace-uri>
            <local-part>string</local-part>
            <prefix></prefix>
        </itemdefinition-typeref>
        <itemdefinition-itemcomponent/>
        <itemdefinition-iscollection>>false</itemdefinition-iscollection>
    </dmn-itemdefinition-info>
    <dmn-itemdefinition-info>
        <itemdefinition-id>_3D4B49DD-700C-4925-99A7-
3B2B873F7800</itemdefinition-id>
        <itemdefinition-name>city</itemdefinition-name>
        <itemdefinition-typeref>
            <namespace-uri>https://github.com/kiegroup/drools/kie-dmn/_60B01F4D-
E407-43F7-848E-258723B5FAC8</namespace-uri>
            <local-part>string</local-part>
            <prefix></prefix>
        </itemdefinition-typeref>
        <itemdefinition-itemcomponent/>
        <itemdefinition-iscollection>>false</itemdefinition-iscollection>
    </dmn-itemdefinition-info>
    <dmn-itemdefinition-info>
        <itemdefinition-id>_B37C49E8-B0D9-4B20-9DC6-
D655BB1CA7B1</itemdefinition-id>
        <itemdefinition-name>Points</itemdefinition-name>
        <itemdefinition-typeref>
            <namespace-uri>https://github.com/kiegroup/drools/kie-dmn/_60B01F4D-
E407-43F7-848E-258723B5FAC8</namespace-uri>
            <local-part>number</local-part>
            <prefix></prefix>
        </itemdefinition-typeref>
        <itemdefinition-itemcomponent/>
        <itemdefinition-iscollection>>false</itemdefinition-iscollection>
    </dmn-itemdefinition-info>
</itemdefinition-itemcomponent>

```

```

        <itemdefinition-iscollection>>false</itemdefinition-iscollection>
      </dmn-itemdefinition-info>
    </dmn-itemdefinition-info>
    <itemdefinition-id>_A4077C7E-B57A-4DEE-9C65-
7769636316F3</itemdefinition-id>
    <itemdefinition-name>tFine</itemdefinition-name>
    <itemdefinition-itemcomponent>
      <dmn-itemdefinition-info>
        <itemdefinition-id>_79B152A8-DE83-4001-B88B-
52DFF0D73B2D</itemdefinition-id>
        <itemdefinition-name>Amount</itemdefinition-name>
        <itemdefinition-typeref>
          <namespace-uri>https://github.com/kiegroup/drools/kie-dmn/_60B01F4D-
E407-43F7-848E-258723B5FAC8</namespace-uri>
          <local-part>number</local-part>
          <prefix></prefix>
        </itemdefinition-typeref>
      </itemdefinition-itemcomponent>
    </dmn-itemdefinition-info>
  </dmn-itemdefinition-info>
  <itemdefinition-id>_D7CB5F9C-9D55-48C2-83EE-
D47045EC90D0</itemdefinition-id>
  <itemdefinition-name>Points</itemdefinition-name>
  <itemdefinition-typeref>
    <namespace-uri>https://github.com/kiegroup/drools/kie-dmn/_60B01F4D-
E407-43F7-848E-258723B5FAC8</namespace-uri>
    <local-part>number</local-part>
    <prefix></prefix>
  </itemdefinition-typeref>
  <itemdefinition-itemcomponent/>
  <itemdefinition-iscollection>>false</itemdefinition-iscollection>
</dmn-itemdefinition-info>
</itemdefinition-itemcomponent>
<itemdefinition-iscollection>>false</itemdefinition-iscollection>
</dmn-itemdefinition-info>
</itemdefinitions>
</decisionsservices/>
</model>
</dmn-model-info-list>
</response>

```

Sample JSON output:

```

{
  "type" : "SUCCESS",
  "msg" : "OK models successfully retrieved from container 'Traffic-Violation_1.0.0-SNAPSHOT'",
  "result" : {
    "dmn-model-info-list" : {
      "models" : [ {
        "model-namespace" : "https://github.com/kiegroup/drools/kie-dmn/_60B01F4D-E407-
43F7-848E-258723B5FAC8",
        "model-name" : "Traffic Violation",
        "model-id" : "_2CD7D1AA-BD84-4B43-AD21-B0342ADE655A",
        "decisions" : [ {

```

```

    "decision-id" : "_23428EE8-DC8B-4067-8E67-9D7C53EC975F",
    "decision-name" : "Fine"
  }, {
    "decision-id" : "_B5EEE2B1-915C-44DC-BE43-C244DC066FD8",
    "decision-name" : "Should the driver be suspended?"
  } ],
  "inputs" : [ {
    "inputdata-id" : "_CEB959CD-3638-4A87-93BA-03CD0FB63AE3",
    "inputdata-name" : "Violation",
    "inputdata-typeRef" : {
      "namespace-uri" : "https://github.com/kielogroup/drools/kie-dmn/_60B01F4D-E407-43F7-848E-258723B5FAC8",
      "local-part" : "tViolation",
      "prefix" : ""
    }
  }, {
    "inputdata-id" : "_B0E810E6-7596-430A-B5CF-67CE16863B6C",
    "inputdata-name" : "Driver",
    "inputdata-typeRef" : {
      "namespace-uri" : "https://github.com/kielogroup/drools/kie-dmn/_60B01F4D-E407-43F7-848E-258723B5FAC8",
      "local-part" : "tDriver",
      "prefix" : ""
    }
  } ],
  "itemDefinitions" : [ {
    "itemdefinition-id" : "_13C7EFD8-B85C-43BF-94D3-14FABE39A4A0",
    "itemdefinition-name" : "tDriver",
    "itemdefinition-typeRef" : null,
    "itemdefinition-itemComponent" : [ {
      "itemdefinition-id" : "_EC11744C-4160-4549-9610-2C757F40DFE8",
      "itemdefinition-name" : "Name",
      "itemdefinition-typeRef" : {
        "namespace-uri" : "https://github.com/kielogroup/drools/kie-dmn/_60B01F4D-E407-43F7-848E-258723B5FAC8",
        "local-part" : "string",
        "prefix" : ""
      }
    },
    "itemdefinition-itemComponent" : [ ],
    "itemdefinition-isCollection" : false
  }, {
    "itemdefinition-id" : "_E95BE3DB-4A51-4658-A166-02493EAAC9D2",
    "itemdefinition-name" : "Age",
    "itemdefinition-typeRef" : {
      "namespace-uri" : "https://github.com/kielogroup/drools/kie-dmn/_60B01F4D-E407-43F7-848E-258723B5FAC8",
      "local-part" : "number",
      "prefix" : ""
    }
  },
  "itemdefinition-itemComponent" : [ ],
  "itemdefinition-isCollection" : false
  }, {
    "itemdefinition-id" : "_7B3023E2-BC44-4BF3-BF7E-773C240FB9AD",
    "itemdefinition-name" : "State",
    "itemdefinition-typeRef" : {
      "namespace-uri" : "https://github.com/kielogroup/drools/kie-dmn/_60B01F4D-E407-

```

```

43F7-848E-258723B5FAC8",
  "local-part" : "string",
  "prefix" : ""
},
"itemdefinition-itemComponent" : [ ],
"itemdefinition-isCollection" : false
}, {
"itemdefinition-id" : "_3D4B49DD-700C-4925-99A7-3B2B873F7800",
"itemdefinition-name" : "City",
"itemdefinition-typeRef" : {
  "namespace-uri" : "https://github.com/kiogroup/drools/kie-dmn/_60B01F4D-E407-
43F7-848E-258723B5FAC8",
  "local-part" : "string",
  "prefix" : ""
},
"itemdefinition-itemComponent" : [ ],
"itemdefinition-isCollection" : false
}, {
"itemdefinition-id" : "_B37C49E8-B0D9-4B20-9DC6-D655BB1CA7B1",
"itemdefinition-name" : "Points",
"itemdefinition-typeRef" : {
  "namespace-uri" : "https://github.com/kiogroup/drools/kie-dmn/_60B01F4D-E407-
43F7-848E-258723B5FAC8",
  "local-part" : "number",
  "prefix" : ""
},
"itemdefinition-itemComponent" : [ ],
"itemdefinition-isCollection" : false
} ],
"itemdefinition-isCollection" : false
}, {
"itemdefinition-id" : "_A4077C7E-B57A-4DEE-9C65-7769636316F3",
"itemdefinition-name" : "tFine",
"itemdefinition-typeRef" : null,
"itemdefinition-itemComponent" : [ {
  "itemdefinition-id" : "_79B152A8-DE83-4001-B88B-52DFF0D73B2D",
  "itemdefinition-name" : "Amount",
  "itemdefinition-typeRef" : {
    "namespace-uri" : "https://github.com/kiogroup/drools/kie-dmn/_60B01F4D-E407-
43F7-848E-258723B5FAC8",
    "local-part" : "number",
    "prefix" : ""
  },
  "itemdefinition-itemComponent" : [ ],
  "itemdefinition-isCollection" : false
} ],
"itemdefinition-id" : "_D7CB5F9C-9D55-48C2-83EE-D47045EC90D0",
"itemdefinition-name" : "Points",
"itemdefinition-typeRef" : {
  "namespace-uri" : "https://github.com/kiogroup/drools/kie-dmn/_60B01F4D-E407-
43F7-848E-258723B5FAC8",
  "local-part" : "number",
  "prefix" : ""
},
"itemdefinition-itemComponent" : [ ],
"itemdefinition-isCollection" : false

```

```

    } ],
    "itemdefinition-isCollection" : false
  }, {
    "itemdefinition-id" : "_9C758F4A-7D72-4D0F-B63F-2F5B8405980E",
    "itemdefinition-name" : "tViolation",
    "itemdefinition-typeRef" : null,
    "itemdefinition-itemComponent" : [ {
      "itemdefinition-id" : "_0B6FF1E2-ACE9-4FB3-876B-5BB30B88009B",
      "itemdefinition-name" : "Code",
      "itemdefinition-typeRef" : {
        "namespace-uri" : "https://github.com/kiogroup/drools/kie-dmn/_60B01F4D-E407-43F7-848E-258723B5FAC8",
        "local-part" : "string",
        "prefix" : ""
      },
    },
    "itemdefinition-itemComponent" : [ ],
    "itemdefinition-isCollection" : false
  }, {
    "itemdefinition-id" : "_27A5DA18-3CA7-4C06-81B7-CF7F2F050E29",
    "itemdefinition-name" : "Date",
    "itemdefinition-typeRef" : {
      "namespace-uri" : "https://github.com/kiogroup/drools/kie-dmn/_60B01F4D-E407-43F7-848E-258723B5FAC8",
      "local-part" : "date",
      "prefix" : ""
    },
    "itemdefinition-itemComponent" : [ ],
    "itemdefinition-isCollection" : false
  }, {
    "itemdefinition-id" : "_8961969A-8A80-4F12-B568-346920C0F038",
    "itemdefinition-name" : "Type",
    "itemdefinition-typeRef" : {
      "namespace-uri" : "https://github.com/kiogroup/drools/kie-dmn/_60B01F4D-E407-43F7-848E-258723B5FAC8",
      "local-part" : "string",
      "prefix" : ""
    },
    "itemdefinition-itemComponent" : [ ],
    "itemdefinition-isCollection" : false
  }, {
    "itemdefinition-id" : "_7450F12A-3E95-4D5E-8DCE-2CB1FAC2BDD4",
    "itemdefinition-name" : "Speed Limit",
    "itemdefinition-typeRef" : {
      "namespace-uri" : "https://github.com/kiogroup/drools/kie-dmn/_60B01F4D-E407-43F7-848E-258723B5FAC8",
      "local-part" : "number",
      "prefix" : ""
    },
    "itemdefinition-itemComponent" : [ ],
    "itemdefinition-isCollection" : false
  }, {
    "itemdefinition-id" : "_0A9A6F26-6C14-414D-A9BF-765E5850429A",
    "itemdefinition-name" : "Actual Speed",
    "itemdefinition-typeRef" : {
      "namespace-uri" : "https://github.com/kiogroup/drools/kie-dmn/_60B01F4D-E407-43F7-848E-258723B5FAC8",

```

```

        "local-part" : "number",
        "prefix" : ""
    },
    "itemdefinition-itemComponent" : [ ],
    "itemdefinition-isCollection" : false
  } ],
  "itemdefinition-isCollection" : false
}],
"decisionServices" : [ ]
}]
}
}
}
}

```

- Execute the model:

[POST] server/containers/{containerId}/dmn



NOTE

The attribute **model-namespace** is automatically generated and is different for every user. Ensure that the **model-namespace** and **model-name** attributes that you use match those of the deployed model.

Example curl request:

```

curl -u wbadm:wbadm -H "accept: application/json" -H "content-type: application/json" -X
POST "http://localhost:8080/kie-server/services/rest/server/containers/traffic-violation_1.0.0-
SNAPSHOT/dmn" -d "{\"model-namespace\" : \"https://github.com/kiegroup/drools/kie-
dmn/_60B01F4D-E407-43F7-848E-258723B5FAC8\", \"model-name\" : \"Traffic Violation\",
\"dmn-context\" : {\"Driver\" : {\"Points\" : 15}, \"Violation\" : {\"Type\" : \"speed\", \"Actual
Speed\" : 135, \"Speed Limit\" : 100}}}"

```

Example JSON request:

```

{
  "model-namespace" : "https://github.com/kiegroup/drools/kie-dmn/_60B01F4D-E407-43F7-
848E-258723B5FAC8",
  "model-name" : "Traffic Violation",
  "dmn-context" :
  {
    "Driver" :
    {
      "Points" : 15
    },
    "Violation" :
    {
      "Type" : "speed",
      "Actual Speed" : 135,
      "Speed Limit" : 100
    }
  }
}
}
}

```

Example XML request (JAXB format):

```

<?xml version="1.0" encoding="UTF-8" standalone="yes"?>
<dmn-evaluation-context>
  <dmn-context xsi:type="jaxbListWrapper" xmlns:xsi="http://www.w3.org/2001/XMLSchema-
instance">
    <type>MAP</type>
    <element xsi:type="jaxbStringObjectPair" key="Violation">
      <value xsi:type="jaxbListWrapper">
        <type>MAP</type>
        <element xsi:type="jaxbStringObjectPair" key="Type">
          <value xsi:type="xs:string"
xmlns:xs="http://www.w3.org/2001/XMLSchema">speed</value>
        </element>
        <element xsi:type="jaxbStringObjectPair" key="Speed Limit">
          <value xsi:type="xs:decimal"
xmlns:xs="http://www.w3.org/2001/XMLSchema">100</value>
        </element>
        <element xsi:type="jaxbStringObjectPair" key="Actual Speed">
          <value xsi:type="xs:decimal"
xmlns:xs="http://www.w3.org/2001/XMLSchema">135</value>
        </element>
      </value>
    </element>
    <element xsi:type="jaxbStringObjectPair" key="Driver">
      <value xsi:type="jaxbListWrapper">
        <type>MAP</type>
        <element xsi:type="jaxbStringObjectPair" key="Points">
          <value xsi:type="xs:decimal"
xmlns:xs="http://www.w3.org/2001/XMLSchema">15</value>
        </element>
      </value>
    </element>
  </dmn-context>
</dmn-evaluation-context>

```



NOTE

Regardless of the request format, the request requires the following elements:

- Model namespace
- Model name
- Context object containing input values

Example JSON response:

```

{
  "type": "SUCCESS",
  "msg": "OK from container 'Traffic-Violation_1.0.0-SNAPSHOT'",
  "result": {
    "dmn-evaluation-result": {
      "messages": [],
      "model-namespace": "https://github.com/kiogroup/drools/kie-dmn/_7D8116DE-ADF5-
4560-A116-FE1A2EAFFF48",
      "model-name": "Traffic Violation",

```



```

"decision-name": [],
"dmn-context": {
  "Violation": {
    "Type": "speed",
    "Speed Limit": 100,
    "Actual Speed": 135
  },
  "Should Driver be Suspended?": "Yes",
  "Driver": {
    "Points": 15
  },
  "Fine": {
    "Points": 7,
    "Amount": 1000
  }
},
"decision-results": {
  "_E1AF5AC2-E259-455C-96E4-596E30D3BC86": {
    "messages": [],
    "decision-id": "_E1AF5AC2-E259-455C-96E4-596E30D3BC86",
    "decision-name": "Should the Driver be Suspended?",
    "result": "Yes",
    "status": "SUCCEEDED"
  },
  "_D7F02CE0-AF50-4505-AB80-C7D6DE257920": {
    "messages": [],
    "decision-id": "_D7F02CE0-AF50-4505-AB80-C7D6DE257920",
    "decision-name": "Fine",
    "result": {
      "Points": 7,
      "Amount": 1000
    },
    "status": "SUCCEEDED"
  }
}
}
}
}
}

```

Example XML (JAXB format) response:

```

<?xml version="1.0" encoding="UTF-8" standalone="yes"?>
<response type="SUCCESS" msg="OK from container 'Traffic_1.0.0-SNAPSHOT'">
  <dmn-evaluation-result>
    <model-namespace>https://github.com/kiegroup/drools/kie-dmn/_A4BCA8B8-CF08-
433F-93B2-A2598F19ECFF</model-namespace>
    <model-name>Traffic Violation</model-name>
    <dmn-context xsi:type="jaxbListWrapper"
xmlns:xsi="http://www.w3.org/2001/XMLSchema-instance">
      <type>MAP</type>
      <element xsi:type="jaxbStringObjectPair" key="Violation">
        <value xsi:type="jaxbListWrapper">
          <type>MAP</type>
          <element xsi:type="jaxbStringObjectPair" key="Type">
            <value xsi:type="xs:string"
xmlns:xs="http://www.w3.org/2001/XMLSchema">speed</value>

```

```

        </element>
        <element xsi:type="jaxbStringObjectPair" key="Speed Limit">
          <value xsi:type="xs:decimal"
xmlns:xs="http://www.w3.org/2001/XMLSchema">100</value>
        </element>
        <element xsi:type="jaxbStringObjectPair" key="Actual Speed">
          <value xsi:type="xs:decimal"
xmlns:xs="http://www.w3.org/2001/XMLSchema">135</value>
        </element>
      </value>
    </element>
    <element xsi:type="jaxbStringObjectPair" key="Driver">
      <value xsi:type="jaxbListWrapper">
        <type>MAP</type>
        <element xsi:type="jaxbStringObjectPair" key="Points">
          <value xsi:type="xs:decimal"
xmlns:xs="http://www.w3.org/2001/XMLSchema">15</value>
        </element>
      </value>
    </element>
    <element xsi:type="jaxbStringObjectPair" key="Fine">
      <value xsi:type="jaxbListWrapper">
        <type>MAP</type>
        <element xsi:type="jaxbStringObjectPair" key="Points">
          <value xsi:type="xs:decimal"
xmlns:xs="http://www.w3.org/2001/XMLSchema">7</value>
        </element>
        <element xsi:type="jaxbStringObjectPair" key="Amount">
          <value xsi:type="xs:decimal"
xmlns:xs="http://www.w3.org/2001/XMLSchema">1000</value>
        </element>
      </value>
    </element>
    <element xsi:type="jaxbStringObjectPair" key="Should the driver be suspended?">
      <value xsi:type="xs:string"
xmlns:xs="http://www.w3.org/2001/XMLSchema">Yes</value>
    </element>
  </dmn-context>
</messages/>
<decisionResults>
  <entry>
    <key>_4055D956-1C47-479C-B3F4-BAEB61F1C929</key>
    <value>
      <decision-id>_4055D956-1C47-479C-B3F4-BAEB61F1C929</decision-id>
      <decision-name>Fine</decision-name>
      <result xsi:type="jaxbListWrapper"
xmlns:xsi="http://www.w3.org/2001/XMLSchema-instance">
        <type>MAP</type>
        <element xsi:type="jaxbStringObjectPair" key="Points">
          <value xsi:type="xs:decimal"
xmlns:xs="http://www.w3.org/2001/XMLSchema">7</value>
        </element>
        <element xsi:type="jaxbStringObjectPair" key="Amount">
          <value xsi:type="xs:decimal"
xmlns:xs="http://www.w3.org/2001/XMLSchema">1000</value>
        </element>
      </result>
    </value>
  </entry>
</decisionResults>

```

```
        </result>
        <messages/>
        <status>SUCCEEDED</status>
    </value>
</entry>
<entry>
    <key>_8A408366-D8E9-4626-ABF3-5F69AA01F880</key>
    <value>
        <decision-id>_8A408366-D8E9-4626-ABF3-5F69AA01F880</decision-id>
        <decision-name>Should the driver be suspended?</decision-name>
        <result xsi:type="xs:string" xmlns:xs="http://www.w3.org/2001/XMLSchema"
xmlns:xsi="http://www.w3.org/2001/XMLSchema-instance">Yes</result>
        <messages/>
        <status>SUCCEEDED</status>
    </value>
</entry>
</decisionResults>
</dmn-evaluation-result>
</response>
```

CHAPTER 8. ADDITIONAL RESOURCES

- *Designing a decision service using DMN models*
- *Testing a decision service using test scenarios*
- *Managing projects in Business Central*
- *Interacting with Red Hat Process Automation Manager using KIE APIs*

PART II. GETTING STARTED WITH PROCESS SERVICES IN RED HAT PROCESS AUTOMATION MANAGER

As a business rules and processes developer, you can use Business Central in Red Hat Process Automation Manager or the Red Hat Process Automation Manager BPMN modeler in VSCode to design business processes to meet specific business requirements. Red Hat Process Automation Manager provides sample projects in Business Central that contain business assets for reference purposes. This document describes how to create a new mortgage process project, data objects, and business process to familiarize yourself with Business Central and the process designer.

You will then refer to the **Mortgage_Process** sample project included in Business Central to review the sample project's business rules, decision tables, and forms. You will build and deploy the **Mortgage_Process** sample project and execute the project's defined functionality.

Prerequisites

- Red Hat JBoss Enterprise Application Platform 7.3 is installed. For details, see the [Red Hat JBoss Enterprise Application Platform 7.3 Installation Guide](#).
- Red Hat Process Automation Manager is installed and configured with KIE Server. For more information, see [Installing and configuring Red Hat Process Automation Manager on Red Hat JBoss EAP 7.3](#).
- Red Hat Process Automation Manager is running and you can log in to Business Central with the **developer** role. For more information, see [Planning a Red Hat Process Automation Manager installation](#).

CHAPTER 9. OVERVIEW

Business Central enables you to automate your business processes. A business process is a diagram that describes the order in which a series of steps must be executed and consists of predefined nodes and connections. Each node represents one step in the process while the connections specify how to transition from one node to another.

For example, a bank offers a housing mortgage loan service. Using Business Central, the housing mortgage department of the bank creates a complete business process for the mortgage loan.

When a customer wants to buy a new property using credit, the following steps occur:

1. The customer contacts a broker at the bank who assists in filing for a mortgage loan.
2. The broker collects information about the property and the customer, such as the salary of the customer, social security number, the property sale price, and the requested loan amount.
3. The broker then submits a request on behalf of the customer.

Whenever a customer submits a request, a new process instance is created. This ensures consistency in the quality of evaluating each request, provides complete visibility into the status of each request, and makes the process efficient and effective.

CHAPTER 10. SAMPLE PROJECTS AND BUSINESS ASSETS IN BUSINESS CENTRAL

Business Central contains sample projects with business assets that you can use as a reference for the rules, processes, or other assets that you create in your own Red Hat Process Automation Manager projects. Each sample project is designed differently to demonstrate process automation, decision management, or business optimization assets and logic in Red Hat Process Automation Manager.



NOTE

Red Hat does not provide support for the sample code included in the Red Hat Process Automation Manager distribution.

The following sample projects are available in Business Central:

- **Course_Scheduling:** (Business optimization) Course scheduling and curriculum decision process. Assigns lectures to rooms and determines a student's curriculum based on factors, such as course conflicts and class room capacity.
- **Dinner_Party:** (Business optimization) Guest seating optimization using guided decision tables. Assigns guest seating based on each guest's job type, political beliefs, and known relationships.
- **Employee_Rostering:** (Business optimization) Employee rostering optimization using decision and solver assets. Assigns employees to shifts based on skills.
- **Evaluation_Process:** (Process automation) Evaluation process using business process assets. Evaluates employees based on performance.
- **IT_Orders:** (Process automation and case management) Ordering case using business process and case management assets. Places an IT hardware order based on needs and approvals.
- **Mortgages:** (Decision management with rules) Loan approval process using rule-based decision assets. Determines loan eligibility based on applicant data and qualifications.
- **Mortgage_Process:** (Process automation) Loan approval process using business process and decision assets. Determines loan eligibility based on applicant data and qualifications.
- **OptaCloud:** (Business optimization) Resource allocation optimization using decision and solver assets. Assigns processes to computers with limited resources.
- **Traffic_Violation:** (Decision management with DMN) Traffic violation decision service using a Decision Model and Notation (DMN) model. Determines driver penalty and suspension based on traffic violations.

10.1. ACCESSING SAMPLE PROJECTS AND BUSINESS ASSETS IN BUSINESS CENTRAL

You can use the sample projects in Business Central to explore business assets as a reference for the rules or other assets that you create in your own Red Hat Process Automation Manager projects.

Prerequisites

- Business Central is installed and running. For installation options, see [Planning a Red Hat Process Automation Manager installation](#).

Procedure

1. In Business Central, go to **Menu → Design → Projects**. If there are existing projects, you can access the samples by clicking on the **MySpace** default space and selecting **Try Samples** from the **Add Project** drop-down menu. If there are no existing projects, click **Try samples**.
2. Review the descriptions for each sample project to determine which project you want to explore. Each sample project is designed differently to demonstrate process automation, decision management, or business optimization assets and logic in Red Hat Process Automation Manager.
3. Select one or more sample projects and click **Ok** to add the projects to your space.
4. In the **Projects** page of your space, select one of the sample projects to view the assets for that project.
5. Select each asset to explore how the project is designed to achieve the specified goal or workflow. Some of the sample projects contain more than one page of assets. Click the left or right arrows in the upper-right corner to view the full asset list.

Figure 10.1. Asset page selection



6. In the upper-right corner of the project **Assets** page, click **Build** to build the sample project or **Deploy** to build the project and then deploy it to KIE Server.



NOTE

You can also select the **Build & Install** option to build the project and publish the KJAR file to the configured Maven repository without deploying to a KIE Server. In a development environment, you can click **Deploy** to deploy the built KJAR file to a KIE Server without stopping any running instances (if applicable), or click **Redeploy** to deploy the built KJAR file and replace all instances. The next time you deploy or redeploy the built KJAR, the previous deployment unit (KIE container) is automatically updated in the same target KIE Server. In a production environment, the **Redeploy** option is disabled and you can click **Deploy** only to deploy the built KJAR file to a new deployment unit (KIE container) on a KIE Server.

To configure the KIE Server environment mode, set the **org.kie.server.mode** system property to **org.kie.server.mode=development** or **org.kie.server.mode=production**. To configure the deployment behavior for a corresponding project in Business Central, go to project **Settings → General Settings → Version**, toggle the **Development Mode** option, and click **Save**. By default, KIE Server and all new projects in Business Central are in development mode. You cannot deploy a project with **Development Mode** turned on or with a manually added **SNAPSHOT** version suffix to a KIE Server that is in production mode.

To review project deployment details, click **View deployment details** in the deployment banner at the top of the screen or in the **Deploy** drop-down menu. This option directs you to the **Menu → Deploy → Execution Servers** page.

CHAPTER 11. CREATING USERS

You can create as many Business Central users as you require. User privileges and settings are controlled by the roles assigned to a user and the groups that a user belongs to. For this example, you must create two new users: **Katy** who will act as the bank's loan manager and approver, and **Bill** who will act as the broker requesting the loan. For more information on creating users, see the **Creating users** chapter of *Installing and configuring Red Hat Process Automation Manager on Red Hat JBoss EAP 7.3*.



In Business Central, you can use groups and roles to control permissions for a collection of users. You can create as many groups and roles as you want but a group must have at least one user.

- For this example, the user or users working on the tasks must be assigned to one or more of the following groups and roles:
 - **approver** group: For the **Qualify** task
 - **broker** group: For the **Correct Data** and **Increase Down Payment** tasks
 - **manager** role: For the **Final Approval** task

Procedure

1. Click the gear icon  in the upper-right corner, and click **Users**.



2. Click , enter **Katy**, click **Next**, and click **Create**.
3. Click **Yes** to set a password and enter **Katy** in both fields, and click **Change**.
4. Enter **Bill**, click **Next**, and click **Create**.
5. Click **Yes** to set a password and enter **Bill** in both fields, and click **Change**.
6. Click the **Groups** tab and click , enter **approver**, and click **Next**.
7. Select **Katy** from the user list, and click **Add selected users**.
8. Enter **broker**, and click **Next**.
9. Select **Bill** from the user list, and click **Add selected users**.
10. Click the **Users** tab, select **Katy**, and click **Edit** → **Roles** → **Add roles**.
11. Select **manager**, click **Add to selected roles**, and click **Save**.
12. Click the **Groups** tab, and click **Edit** → **Groups** → **Add to groups**.
13. Select **approver** and **kie-server**, and click **Add to selected groups**.
14. Click **Save**.
15. Click the **Users** tab, select **Bill** from the user list, click **Edit** → **Roles** → **Add roles**.
16. Select **user**, and click **Add to selected roles**.

17. Click the **Groups** tab, click  , select **kie-server**, and click **Add to selected groups**.
18. Click **Save**.

CHAPTER 12. CREATING AND EXECUTING DMN AND BPMN MODELS USING MAVEN

You can use Maven archetypes to develop DMN and BPMN models in VSCode using the Red Hat Process Automation Manager VSCode extension instead of Business Central. You can then integrate your archetypes with your Red Hat Process Automation Manager decision and process services in Business Central as needed. This method of developing DMN and BPMN models is helpful for building new business applications using the Red Hat Process Automation Manager VSCode extension.

Procedure

1. In a command terminal, navigate to a local folder where you want to store the new Red Hat Process Automation Manager project.
2. Enter the following command to generate a project within a defined folder using the following Maven archetype:

Generating a project using Maven archetype

```
mvn archetype:generate \
  -DarchetypeGroupId=org.kie \
  -DarchetypeArtifactId=kie-kjar-archetype \
  -DarchetypeVersion=7.52.0.Final-redhat-00007
```

This command generates a Maven project with required dependencies and generates required directories and files to build your business application. You can set up and use Git version-control system (recommended) when developing a project.

If you want to generate multiple projects in the same directory, you can specify the **artifactId** and **groupId** of the generated business application by adding **-DgroupId=<groupid> -DartifactId=<artifactId>** to the previous command.

3. In your VSCode IDE, click **File**, select **Open Folder**, and navigate to the folder that is generated using the previous command.
4. Before creating the first asset, set a package for your business application, for example, **org.kie.businessapp**, and create respective directories in the following paths:

- **PROJECT_HOME/src/main/java**
- **PROJECT_HOME/src/main/resources**
- **PROJECT_HOME/src/test/resources**

For example, you can create **PROJECT_HOME/src/main/java/org/kie/businessapp** for **org.kie.businessapp** package.

5. Use VSCode to create assets for your business application. You can create the assets supported by Red Hat Process Automation Manager VSCode extension using the following ways:
 - To create a business process, create a new file with **.bpmn** or **.bpmn2** in **PROJECT_HOME/src/main/java/org/kie/businessapp** directory, such as **Process.bpmn**.

- To create a DMN model, create a new file with **.dmn** in **PROJECT_HOME/src/main/java/org/kie/businessapp** directory, such as **AgeDecision.dmn**.
 - To create a test scenario simulation model, create a new file with **.scesim** in **PROJECT_HOME/src/main/java/org/kie/businessapp** directory, such as **TestAgeScenario.scesim**.
6. After you create the assets in your Maven archetype, navigate to the root directory (contains **pom.xml**) of the project in the command line and run the following command to build the knowledge JAR (KJAR) of your project:

```
mvn clean install
```

If the build fails, address any problems described in the command line error messages and try again to validate the project until the build is successful. However, if the build is successful, you can find the artifact of your business application in **PROJECT_HOME/target** directory.



NOTE

Use **mvn clean install** command often to validate your project after each major change during development.

You can deploy the generated knowledge JAR (KJAR) of your business application on a running KIE Server using the REST API. For more information about using REST API, see [Interacting with Red Hat Process Automation Manager using KIE APIs](#).

CHAPTER 13. CREATING THE MORTGAGE-PROCESS PROJECT

A project is a container for assets such as data objects, business processes, guided rules, decision tables, and forms. The project that you are creating is similar to the existing **Mortgage_Process** sample project in Business Central.

Procedure

1. In Business Central, go to **Menu → Design → Projects**.
Red Hat Process Automation Manager provides a default space called **MySpace**, as shown in the following image. You can use the default space to create and test example projects.

Figure 13.1. Default space



2. Click **Add Project**.
3. Enter **mortgage-process** in the **Name** field.
4. Click **Configure Advanced Options** and modify the GAV fields with the following values:
 - **Group ID: com.myspace**
 - **Artifact ID: mortgage-process**
 - **Version: 1.0.0**
5. Click **Add**.

The **Assets** view of the project opens.

CHAPTER 14. CREATING THE MORTGAGE-PROCESS DATA OBJECTS

Data objects are the building blocks for the rule assets that you create. Data objects are custom data types implemented as Java classes in specified packages of your project. These custom data types determine what data your assets and your decision services are based on.

The mortgage process project uses the following data objects:

- **Applicant**
- **Property**
- **ValidationErrorDO**
- **Application**

14.1. CREATING THE APPLICANT DATA OBJECT

Follow these steps to create the **Applicant** data object, which contains information about the applicant. This is the basic information required to apply for the loan in this tutorial.

Procedure

1. In Business Central, click on the **MySpace** default space.
2. Click **Menu** → **Design** → **Projects** and click **mortgage-process**.
3. Click **Add Asset** and select **Data Object**.
4. Enter **Applicant** in the **Data Object** field of the **Create new Data Object** window.
5. Select **com.myspace.mortgage_app** from the **Package** drop-down menu and click **Ok**.
6. Enter **Applicant** in the **Label** field of the '**Applicant**'- **general properties** section.
7. Click **+add field** and input the following **Applicant** data object values. Click **Create and continue** after each addition. For the last addition, click **Create**.

Figure 14.1. Applicant data object field values

| Identifier | Label | Type | |
|--------------|---------------|---------|--------|
| address | Address | String | Delete |
| annualincome | Annual Income | Integer | Delete |
| creditrating | Credit Rating | Integer | Delete |
| name | Name | String | Delete |
| ssn | SSN | Integer | Delete |

8. Click **Save**.

14.2. CREATING THE PROPERTY DATA OBJECT

Follow these steps to create the **Property** data object, which contains information about the property details, such as the property age and price.

Procedure

1. In Business Central, click on the **MySpace** default space.
2. Click **Menu** → **Design** → **Projects** and click **mortgage-process**.
3. Click **Add Asset** and select **Data Object**.
4. Enter **Property** in the **Data Object** field of the **Create new Data Object** window.
5. Select **com.myspace.mortgage_app** from the **Package** drop-down menu and click **Ok**.
6. Enter **Property** in the **Label** field of the '**Property**'- **general properties** section.
7. Click **+add field** and input the following **Property** data object values. Click **Create and continue** after each addition. For the last addition, click **Create**.

Figure 14.2. Property data object field values

| Identifier | Label | Type | |
|------------|---------------------|---------|--------|
| address | Address of property | String | Delete |
| age | Age of property | Integer | Delete |
| locale | Locale | String | Delete |
| saleprice | Sale Price | Integer | Delete |

8. Click **Save**.

14.3. CREATING THE VALIDATIONERRORDO DATA OBJECT

Follow these steps to create the **ValidationErrorDO** data object, which specifies the cause of an application error.

Procedure

1. In Business Central, click on the **MySpace** default space.
2. Click **Menu** → **Design** → **Projects** and click **mortgage-process**.
3. Click **Add Asset** and select **Data Object**.
4. Enter **ValidationErrorDO** in the **Data Object** field of the **Create new Data Object** window.
5. Select **com.myspace.mortgage_app** from the **Package** drop-down menu and click **Ok**.

- Enter **ValidationErrorDO** in the **Label** field of the 'ValidationErrorDO'- **general properties** section.
- Click **+add field** and input the following **ValidationErrorDO** data object values. Click **Create and continue** after each addition. For the last addition, click **Create**.

Figure 14.3. ValidationErrorDO data object field values

The screenshot shows the 'Model' tab of the 'ValidationErrorDO.java - Data Objects' interface. It displays a table with the following data:

| Identifier | Label | Type | |
|------------|-----------------|--------|--------|
| error | Error and cause | String | Delete |

- Click **Save**.

14.4. CREATING THE APPLICATION DATA OBJECT

Follow these steps to create the **Application** data object, which contains information about the mortgage details, such as the down payment and the mortgage amount.

Procedure

- In Business Central, click on the **MySpace** default space.
- Click **Menu** → **Design** → **Projects** and click **mortgage-process**.
- Click **Add Asset** and select **Data Object**.
- Enter **Application** in the **Data Object** field of the **Create new Data Object** window.
- Select **com.myspace.mortgage_app** from the **Package** drop-down menu and click **Ok**.
- Enter **Application** in the **Label** field of the 'Application'- **general properties** section.
- Click **+add field** and input the following **Application** data object values. Click **Create and continue** after each addition. For the last addition, click **Create**.

Figure 14.4. Application data object field values

The screenshot shows the 'Model' tab of the 'Application.java - Data Objects' interface. It displays a table with the following data:

| Identifier | Label | Type | |
|----------------|-----------------------|------------------|--------|
| amortization | Years of amortization | Integer | Delete |
| applicant | Applicant | Applicant | Delete |
| downpayment | Down Payment | Integer | Delete |
| errors | Error details | Validation Error | Delete |
| mortgageamount | Mortgage amount | Integer | Delete |
| property | Property | Property | Delete |

8. Click **Save**.

CHAPTER 15. BUSINESS PROCESSES IN BUSINESS CENTRAL

A business process is a diagram that describes the order in which a series of steps must be executed using a flow chart. A business process consists of a collection of nodes that are linked to each other using connections. Each of the nodes represents one step in the overall process while the connections specify how to transition from one node to the other.

The sample **Mortgage_Process** contains the following predefined **MortgageApprovalProcess** business process.

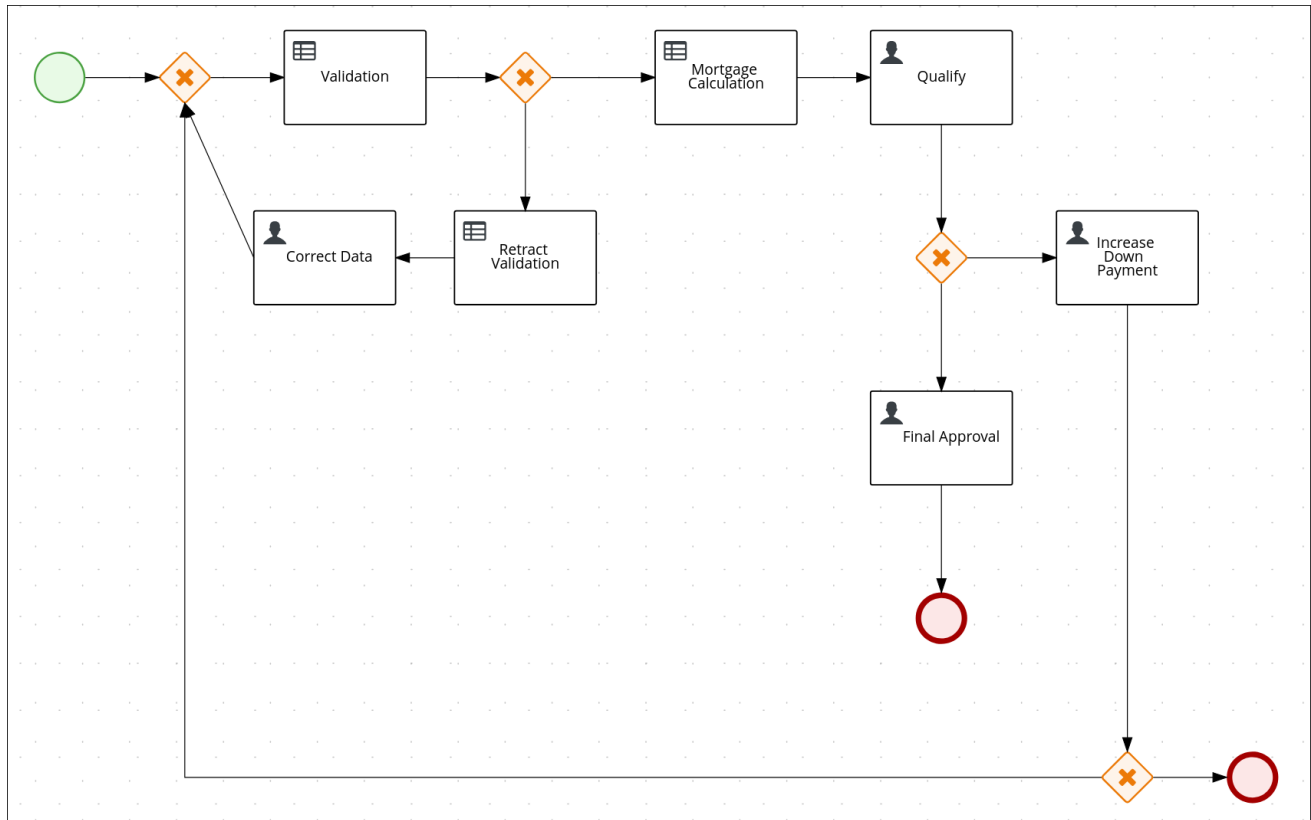



15.1. CREATING THE BUSINESS PROCESS

The following procedures guide you through the creation of tasks, connections, and gateways that make up the **MortgageApprovalProcess** business process. The mortgage validation business process determines whether a mortgage application contains all required data. If the specified data requirements are met, the application proceeds on to the mortgage calculation business process.

Procedure

1. In Business Central, go to **Menu → Design → Projects → Mortgage-Process**.
2. Click **Add Asset → Business Process**.
3. Enter the following values:
 - **Business Process: MortgageApprovalProcess**
 - **Package:** Select **com.myspace.mortgage_app**
The **Package** specifies the location inside the existing project where the asset will be created. In this example, it is created in **com/myspace/mortgage_app**.

4. Click **Ok**. The diagram editor opens.
5. In the upper-right corner, click the **Properties**  icon.
6. Scroll down and expand **Process Data** and click  in the **Process Variables** section.
7. Enter the following values:
 - **Name: application**
 - **Data Type: Application [com.myspace.mortgage_app]**

15.1.1. Creating outgoing connections and exclusive gateways

This section shows you how to create outgoing connections, exclusive gateways, and business rule tasks. Use exclusive gateways to make decisions and react to events based on the available data.

Red Hat Process Automation Manager contains a predefined selection of node types to simplify business process creation. The predefined node panel is located on the left side of the diagram editor.

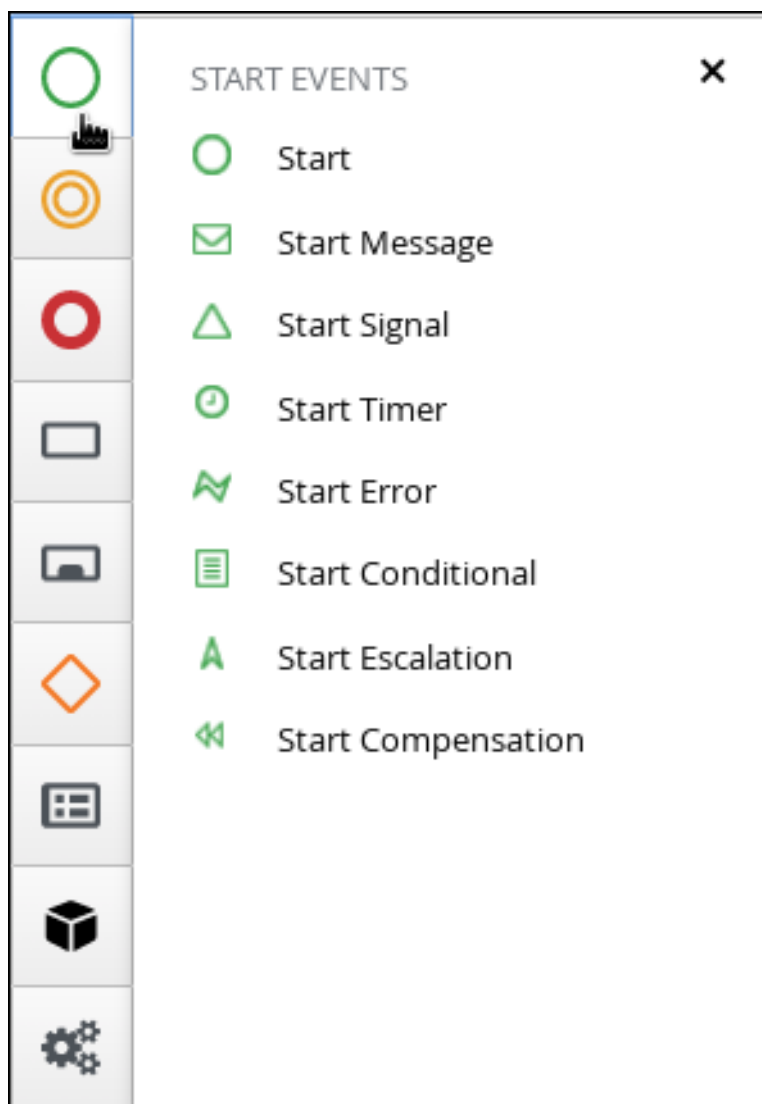

Procedure

1. Drag a start event node onto the canvas.
2. Create an outgoing connection from the start event to an exclusive gateway:
 - a. On the canvas, click the start event node and click the **Create Parallel** icon.

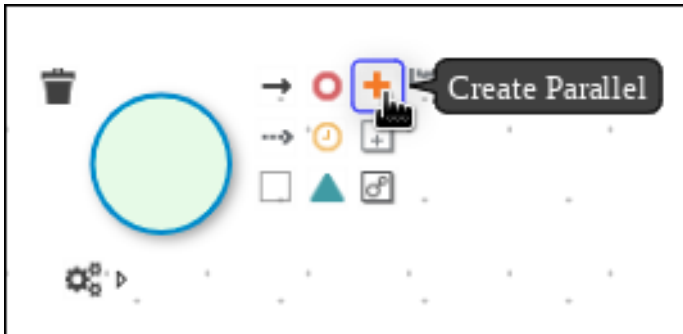

- b. Hover over the  icon of the parallel and click the **Convert into Exclusive** icon.

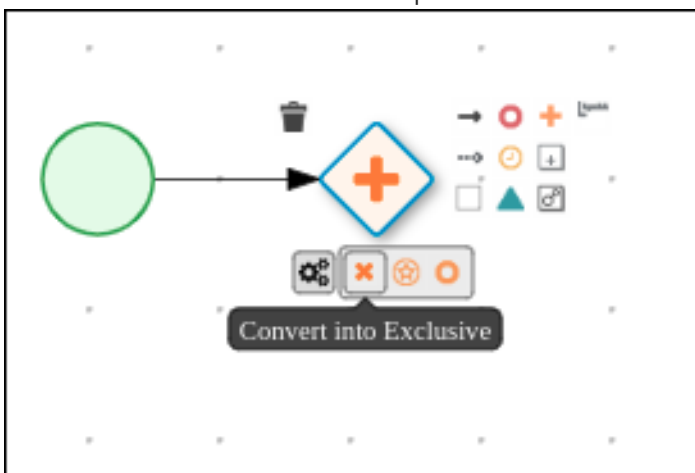

3. Create an outgoing connection from the exclusive gateway to a business rule task:
 - a. On the canvas, click the exclusive gateway and click the **Create Task** icon.

- b. Hover over the  icon of the task and click the **Convert into Business Rule** icon.

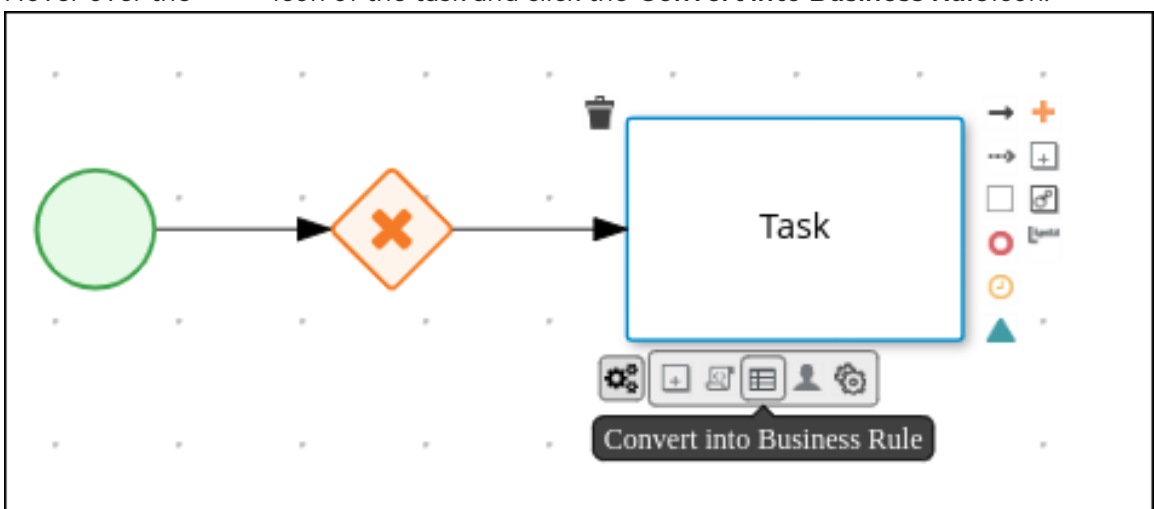

4. Configure the business rule task:
 - a. Click the business rules task.

- b. If the **Properties** panel is not open, in the upper-right corner click the **Properties**  icon.
- c. In the **Properties** panel, enter **Validation** in the **Name** field.
- d. Expand **Implementation/Execution**, select **New** from the **Rule Flow Group** menu, and input **validation**.
- e. In the **On Exit Action** field, enter the following Java expression:

```
System.out.println(application.getProperty());
```

- f. Expand **Data Assignments** and click  next to **Assignments**.
- g. In the **Validation Data I/O** window, click **Add** and create the following assignments:
 - Data Inputs and Assignments
 - Name: application
 - Data Type: Application [com.myspace.mortgage_app]
 - Source: application
 - Data Outputs and Assignments
 - Name: application
 - Data Type: Application [com.myspace.mortgage_app]
 - Target: application

Figure 15.1. Validation Data I/O assignments



5. Click **OK** in the **Validation Data I/O** window.
6. Above the canvas, click **Save** to confirm your changes.

15.1.2. Defining the validation data

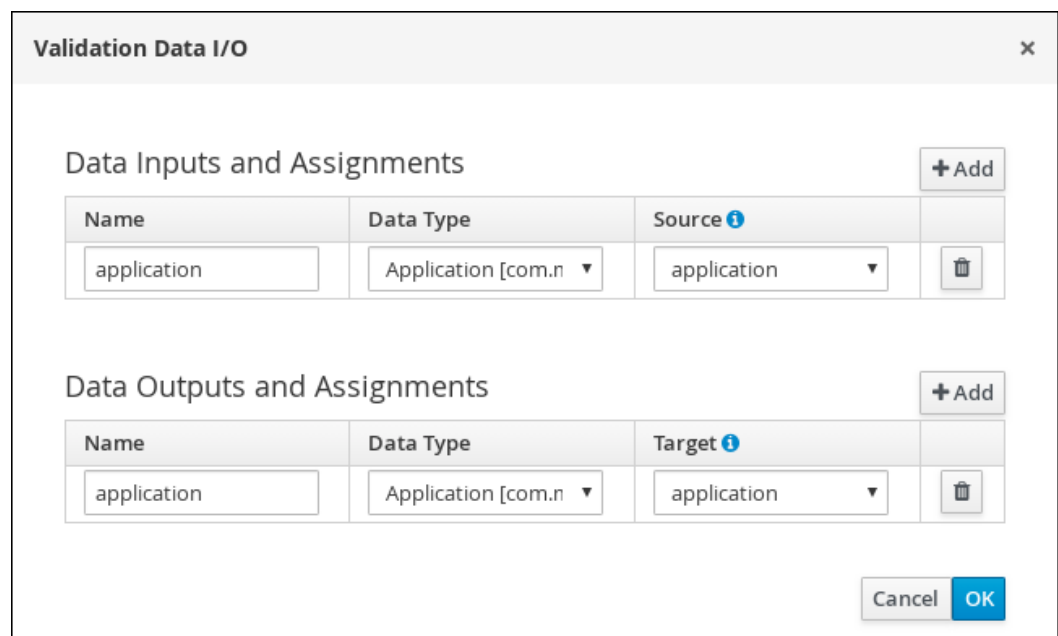
This section shows you how to define the validation data that determines whether the application data is correct, contains an error, or has missing information.

Procedure

1. Create an outgoing connection from the **Validation** task to an exclusive gateway:
 - a. Click the **Validation** task and click the **Create Parallel** icon.

- b. Hover over the  icon of the parallel and click the **Convert into Exclusive** icon.

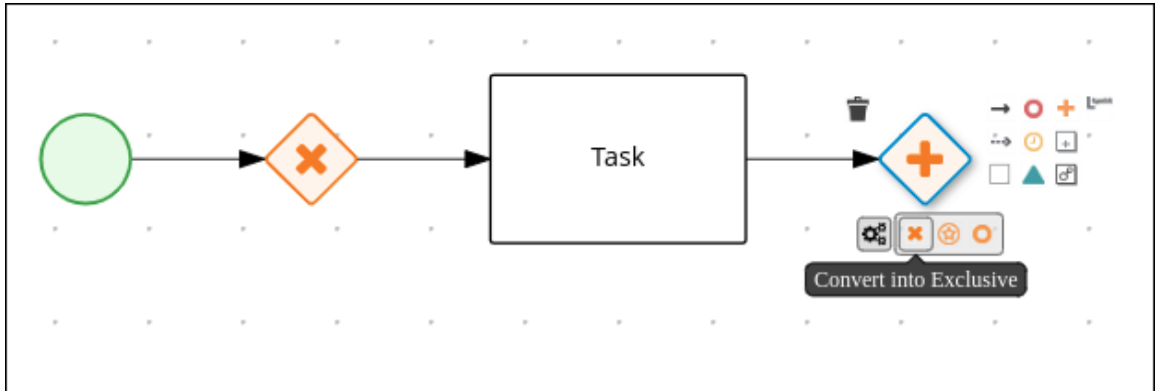

2. Create an outgoing connection from the exclusive gateway to a new business rule task:
 - a. Click the exclusive gateway and click the **Create Task** icon.
 - b. Drag the new task below the exclusive gateway as shown below.

- c. Hover over the  icon of the task and click the **Convert into Business Rule** icon.

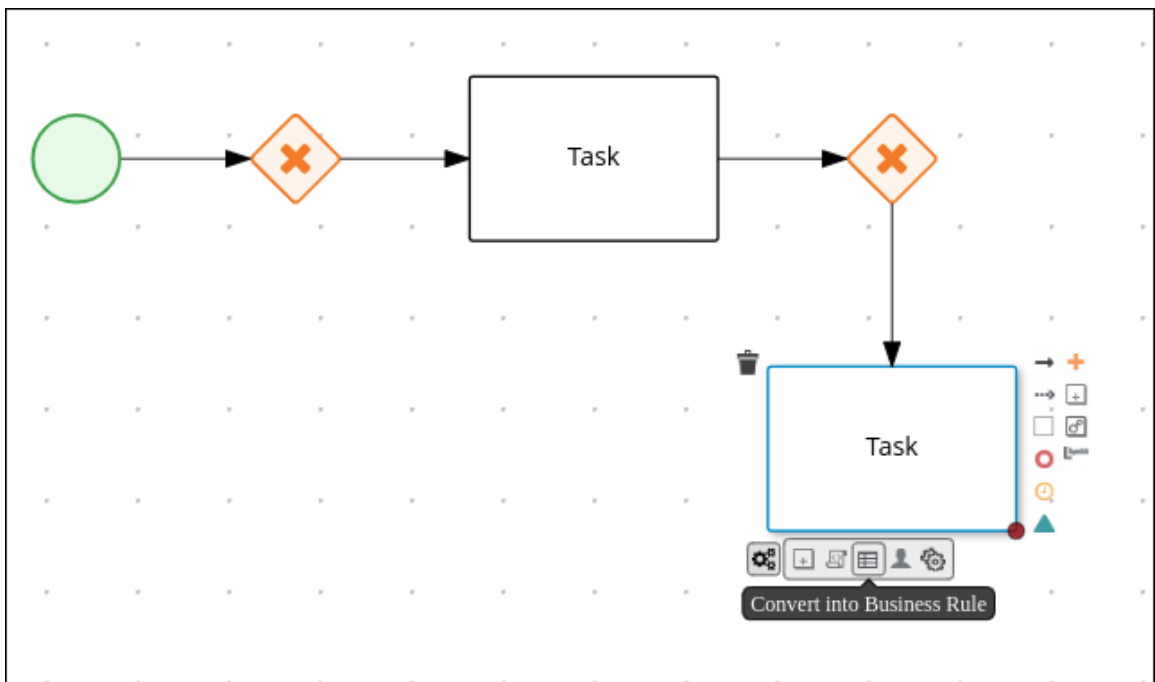

- d. If the **Properties** panel is not open, in the upper-right corner click the **Properties**  icon.
 - e. In the **Properties** panel, enter **Retract Validation** in the **Name** field.

- f. Expand **Implementation/Execution**, select **New** from the **Rule Flow Group** menu, and input **error**.
3. Configure the connection between the exclusive gateway and the business rule task:
 - a. Click the connection.

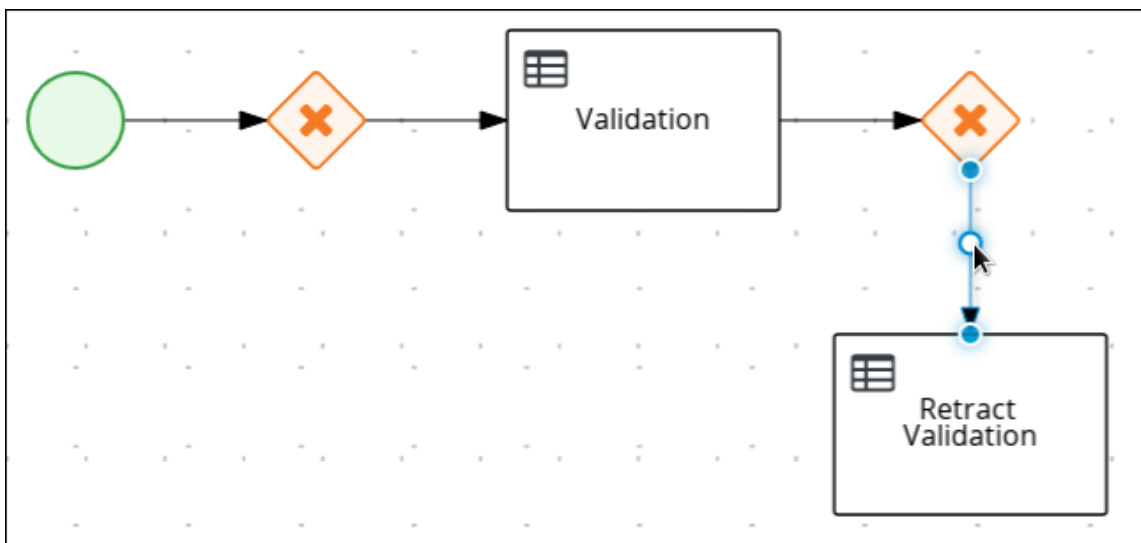

- b. If the **Properties** panel is not open, in the upper-right corner click the **Properties**  icon.
- c. In the **Properties** panel, enter **Invalid** in the **Name** field.
- d. Expand **Implementation/Execution** and select **Expression** in the **Condition Expression** section.
- e. From the list, select **drools** and enter **ValidationErrorDO()** in the **Condition Expression** field.

Condition Expression

Condition
 Expression

ValidationErrorDO()

Java

JavaScript

MVEL

DROOLS

FEEL

DROOLS ▼

4. Create an outgoing connection from the **Retract Validation** task to a new user task:
 - a. Click the **Retract Validation** task and click the **Create Task** icon.
 - b. Drag the new task below the **Validation** task as shown below.

- c. Hover over the  icon of the task and click the **Convert into User** icon.

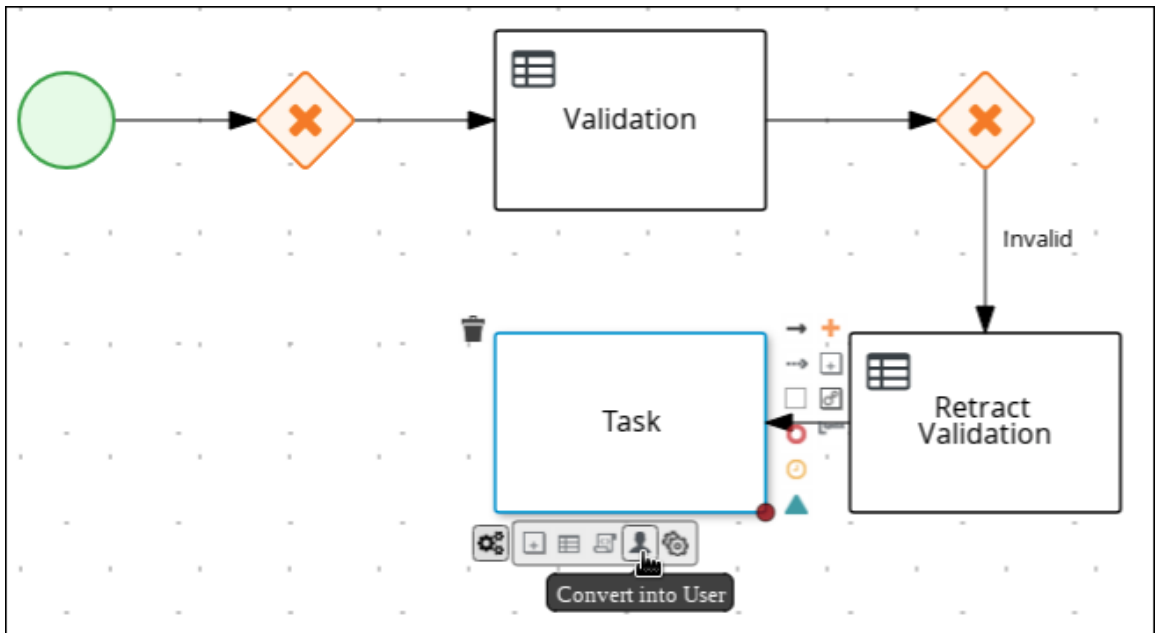

- d. Click on the new user task and in the **Properties** panel, enter **Correct Data** in the **Name** field.
 - e. Expand **Implementation/Execution** and enter **CorrectData** in the **Task Name** field.
 - f. Select **New** from the **Groups** menu, and input **broker**.
 - g. Click  next to **Assignments**.
 - h. In the **Correct Data Data I/O** window, click **Add** and create the following assignments:
 - Name: application
 - Data Type: Application [com.myspace.mortgage_app]
 - Source: application
 - Data Outputs and Assignements
 - Name: application
 - Data Type: Application [com.myspace.mortgage_app]
 - Target: application

Figure 15.2. Correct Data Data I/O assignments

Correct Data Data I/O ✕

Data Inputs and Assignments + Add

| Name | Data Type | Source i | |
|--|-----------------------|---|---|
| <input type="text" value="application"/> | Application [com.n ▼] | application ▼ | ✕ |

Data Outputs and Assignments + Add

| Name | Data Type | Target i | |
|--|-----------------------|---|---|
| <input type="text" value="application"/> | Application [com.n ▼] | application ▼ | ✕ |

Cancel OK

- i. Click **OK** in the **Correct Data Data I/O** window.
 - j. Above the canvas, click **Save** to confirm your changes.
5. Click on the **Correct Data** user task, then click the **Create sequence Flowicon** and drag it back to the first exclusive gateway. Your workflow should look similar to the following diagram:

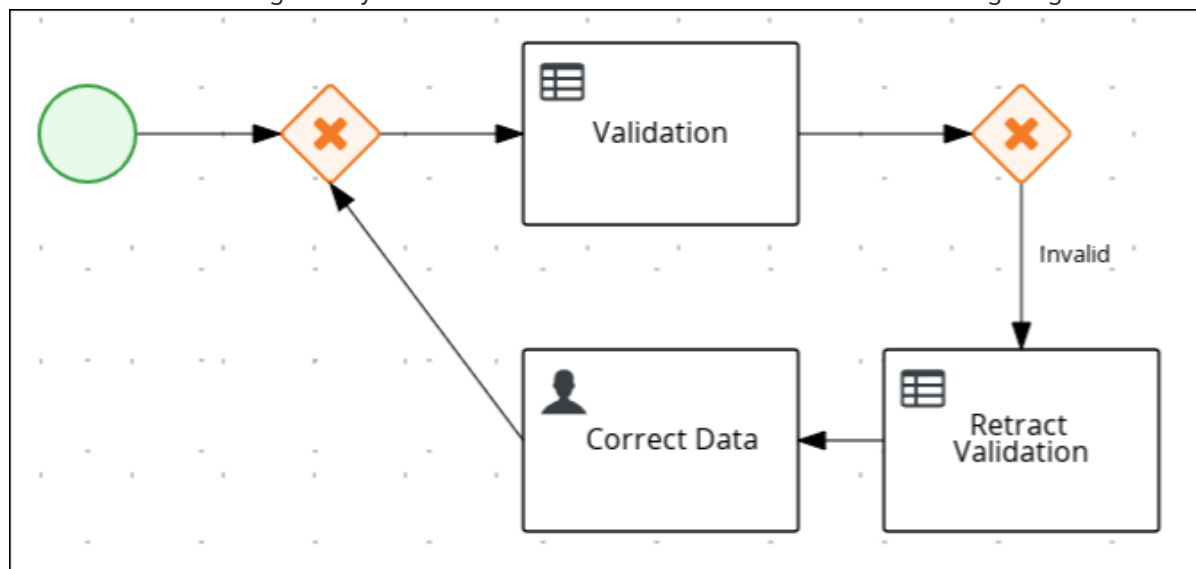

15.1.3. Calculating the mortgage

The mortgage calculation business process determines the applicant's mortgage borrowing limit.

Procedure

1. Return to the second exclusive gateway and create an outgoing connection to a new business rule task.
2. Click the created connection and in the **Properties** panel, input **Valid** in the **Name** field.

- a. Expand **Implementation/Execution** and select **Expression** in the **Condition Expression** section.
 - b. From the list, select **drools** and enter **not ValidationErrorDO()** in the **Condition Expression** field.
3. Click the new business rule task and in the **Properties** panel, input **Mortgage Calculation** in the **Name** field.

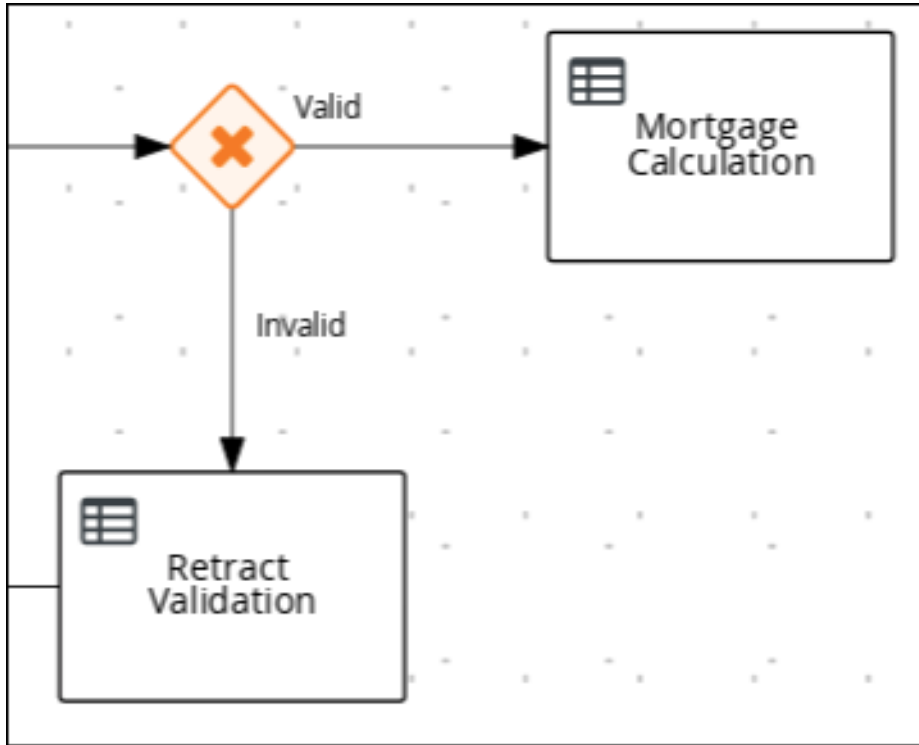

- a. Expand **Implementation/Execution**, select **New** from the **Rule Flow Group** menu, and input **mortgagecalculation**.
4. Expand **Data Assignments** and click  next to **Assignments**.
5. In the **Mortgage Calculation Data I/O** window, click **Add** to create the following assignments and click **Save**.

Figure 15.3. Mortgage Calculation Data I/O assignments

The screenshot shows a window titled "Mortgage Calculation Data I/O" with a close button (X) in the top right corner. The window is divided into two sections: "Data Inputs and Assignments" and "Data Outputs and Assignments".

Data Inputs and Assignments

| Name | Data Type | Source <i>i</i> | |
|-------------|-----------------------|-----------------|--|
| application | Application [com.n ▼] | application ▼ | |

Data Outputs and Assignments

| Name | Data Type | Target <i>i</i> | |
|-------------|-----------------------|-----------------|--|
| application | Application [com.n ▼] | application ▼ | |

At the bottom right of the window are "Cancel" and "OK" buttons.

6. Click **OK** in the **Mortgage Calculation Data I/O** window.

7. Click an empty space on the canvas, scroll down, expand **Process Data**, and click  next to **Process Variables**. Enter the following values:

- **Name: inlimit**
- **Data Type: Boolean**

8. Create an outgoing connection from the **Mortgage Calculation** task to a new user task.

9. Click the user task, enter **Qualify** in the **Name** field.

10. Expand **Implementation/Execution** and enter **Qualify** in the **Task Name** field.

11. Select **New** from the **Groups** menu, and input **approver**.

12. Click  next to **Assignments**. In the **Qualify Data I/O** window, click **Add** to create the following assignments:

Figure 15.4. Qualify Data I/O assignments

Qualify Data I/O
✕

Data Inputs and Assignments + Add

| Name | Data Type | Source i | |
|--|-----------------------|---|---|
| <input type="text" value="application"/> | Application [com.n ▼] | application ▼ | ✕ |

Data Outputs and Assignments + Add

| Name | Data Type | Target i | |
|--------------------------------------|-----------|---|---|
| <input type="text" value="inlimit"/> | Boolean ▼ | inlimit ▼ | ✕ |

Cancel
OK

13. Click **OK** in the **Qualify Data I/O** window.
14. Above the canvas, click **Save** to confirm your changes.
15. Click on the **Qualify** user task, click on the **Create parallel** menu icon, and convert it to an exclusive gateway.
16. Drag the new exclusive gateway below the **Qualify** user task.
17. Create an outgoing connection from the exclusive gateway and connect it to a new user task.
18. Click the connection and input **In Limit** in the **Name** field of the **Properties** panel.
19. Expand **Implementation/Execution** and select **Condition** in the **Condition Expression** section.
20. Select **inlimit** from the **Process Variable** drop-down menu and select **Is true** from the **Condition** drop-down menu.

General

Name
In Limit

Documentation

Implementation/Execution

Priority

Condition Expression

Condition Expression

Process Variable ⓘ
inlimit

Condition ⓘ
Is true

21. Click the user task, enter **Final Approval** in the **Name** field.
22. Expand **Implementation/Execution** and enter **FinalApproval** in the **Task Name** field.
23. Select **New** from the **Groups** menu, and input **manager**.
24. Click  next to **Assignments**. In the **Final Approval Data I/O** window, click **Add** to create the following assignments:

Figure 15.5. Final Approval Data I/O assignments

The screenshot shows a window titled "Final Approval Data I/O" with a close button (X) in the top right corner. The window is divided into two main sections: "Data Inputs and Assignments" and "Data Outputs and Assignments".

Data Inputs and Assignments

| Name | Data Type | Source ? | |
|-------------|-----------------------|-----------------------|----|
| application | Application [com.n ▼] | application ▼ | 🗑️ |
| inlimit | Boolean ▼ | inlimit ▼ | 🗑️ |

There is a "+ Add" button to the right of the "Data Inputs and Assignments" section.

Data Outputs and Assignments

There is a "+ Add" button to the right of the "Data Outputs and Assignments" section.

At the bottom right of the window, there are "Cancel" and "OK" buttons.

25. Click **OK** in the **Final Approval Data I/O** window.
26. Above the canvas, click **Save** to confirm your changes.

15.1.4. Increasing the down payment

The increasing the down payment business process checks to see if the applicant qualifies for the loan by increasing their down payment. The final result is either the final loan approval, or loan denial based on the applicant's inability to increase the down payment.

Procedure

1. Click on the **Final Approval** user task and select **Create End** from the user task quick menu.
2. Move the end event below the **Final Approval** user task.

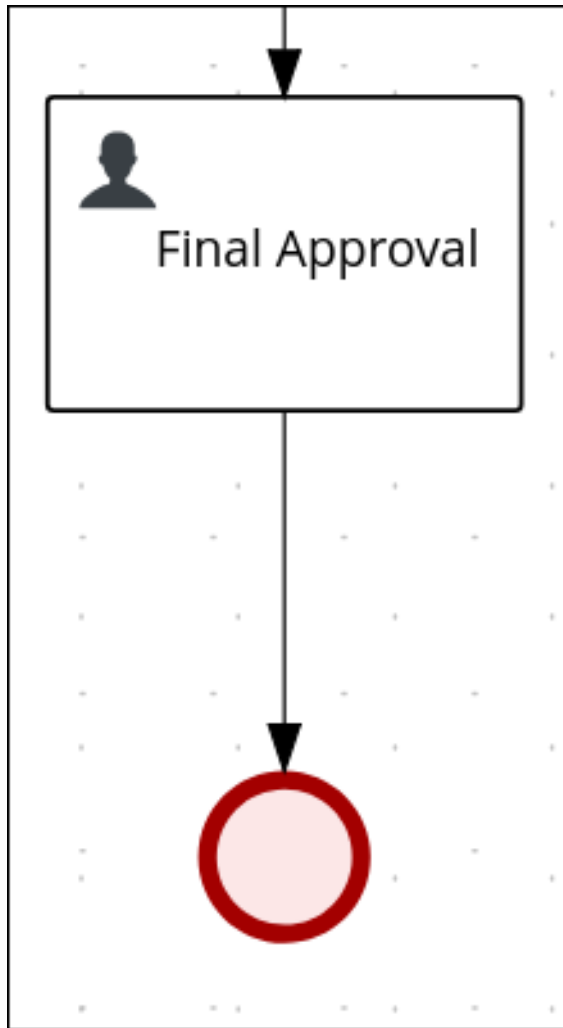

3. Return to the exclusive gateway that connects with the **Final Approval** user task. Create a second outgoing connection and connect it to a new user task.

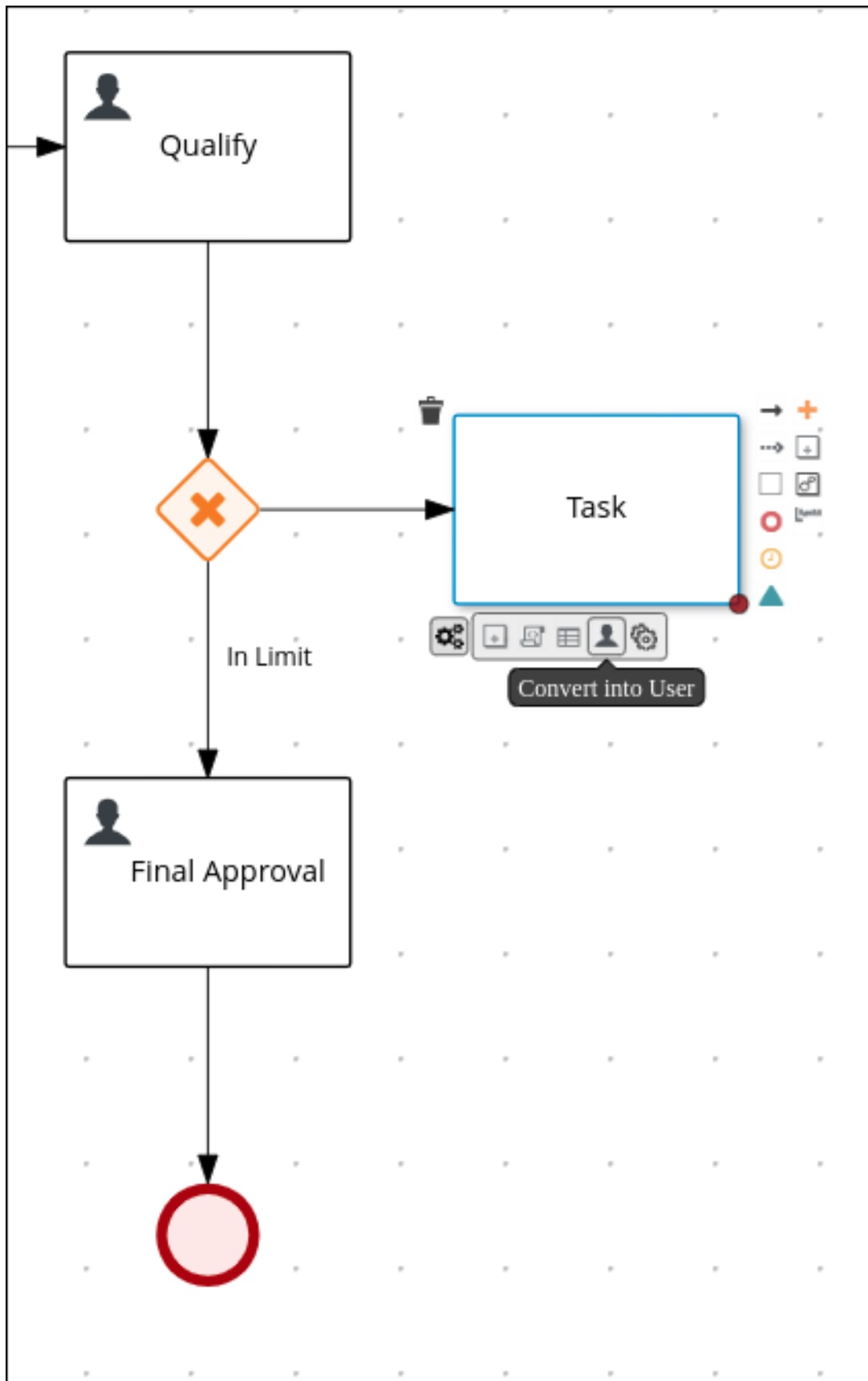





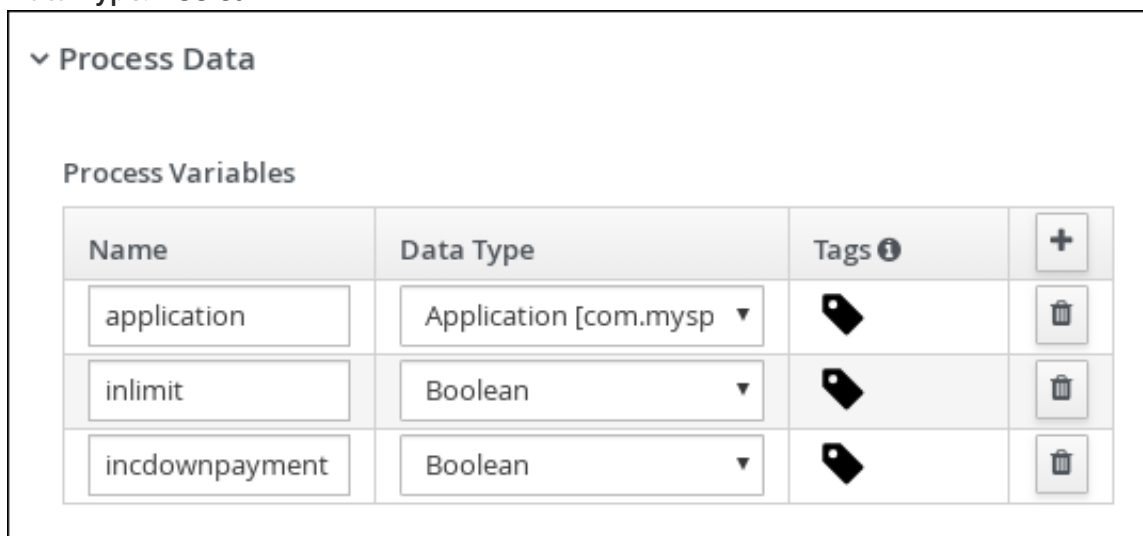

4. Click the connection and input **Not in Limit** in the **Name** field of the **Properties** panel.
5. Expand **Implementation/Execution** and select **Condition** in the **Condition Expression** section.
6. Select **inlimit** from the **Process Variable** drop-down menu and select **Is false** from the **Condition** drop-down menu.

7. Click an empty space on the canvas, scroll down, expand **Process Data**, and click  next to **Process Variables**. Enter the following values:

- **Name: incdownpayment**
- **Data Type: Boolean**



Process Variables

| Name | Data Type | Tags ⓘ | + |
|----------------|--------------------------|---|---|
| application | Application [com.mysp ▼] |  |  |
| inlimit | Boolean ▼ |  |  |
| incdownpayment | Boolean ▼ |  |  |

8. Click the new user task and in the **Properties** panel, input **Increase Down Payment** in the **Name** field.

9. Expand **Implementation/Execution** and enter **IncreaseDownPayment** in the **Task Name** field.

10. Select **New** from the **Groups** menu, and input **broker**.

11. Click  next to **Assignments**. In the **Increase Down Payment Data I/O** window, click **Add** to create the following assignments:

Figure 15.6. Increase Down Payment Data I/O assignments

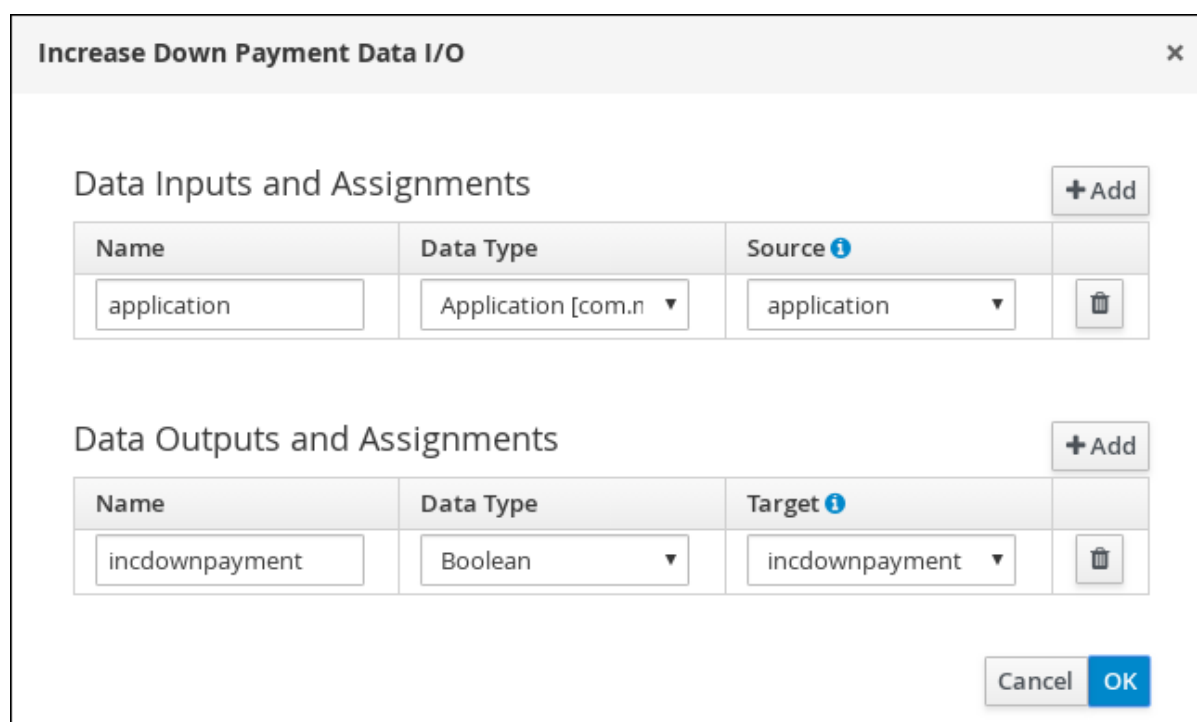

Increase Down Payment Data I/O

Data Inputs and Assignments + Add

| Name | Data Type | Source ⓘ | |
|-------------|-----------------------|---------------|---|
| application | Application [com.n ▼] | application ▼ |  |

Data Outputs and Assignments + Add

| Name | Data Type | Target ⓘ | |
|----------------|-----------|------------------|---|
| incdownpayment | Boolean ▼ | incdownpayment ▼ |  |

Cancel OK

12. Click **OK** in the **Increase Down Payment Data I/O** window.
13. Above the canvas, click **Save** to confirm your changes.
14. Click on the **Increase Down Payment** user task, click on the **Create parallel** menu icon, and convert it to an exclusive gateway.
15. Drag the new exclusive gateway below the **Increase Down Payment** user task.
16. Create an outgoing connection from the exclusive gateway to an end event.
17. Click the connection and input **Down payment not increased** in the **Name** field of the **Properties** panel.
18. Expand **Implementation/Execution** and select **Expression** in the **Condition Expression** section.
19. Input **return !incdownpayment;** and select **java** from the drop-down menu.
20. Create an outgoing connection from the exclusive gateway and connect it to the first exclusive gateway.
21. Click the connection and input **Down payment increased** in the **Name** field of the **Properties** panel.
22. Expand **Implementation/Execution** and select **Expression** in the **Condition Expression** section.
23. Input **return incdownpayment;** and select **java** from the drop-down menu.
24. Above the canvas, click **Save** to confirm your changes and save the entire business process.

Figure 15.7. Final version of the business process

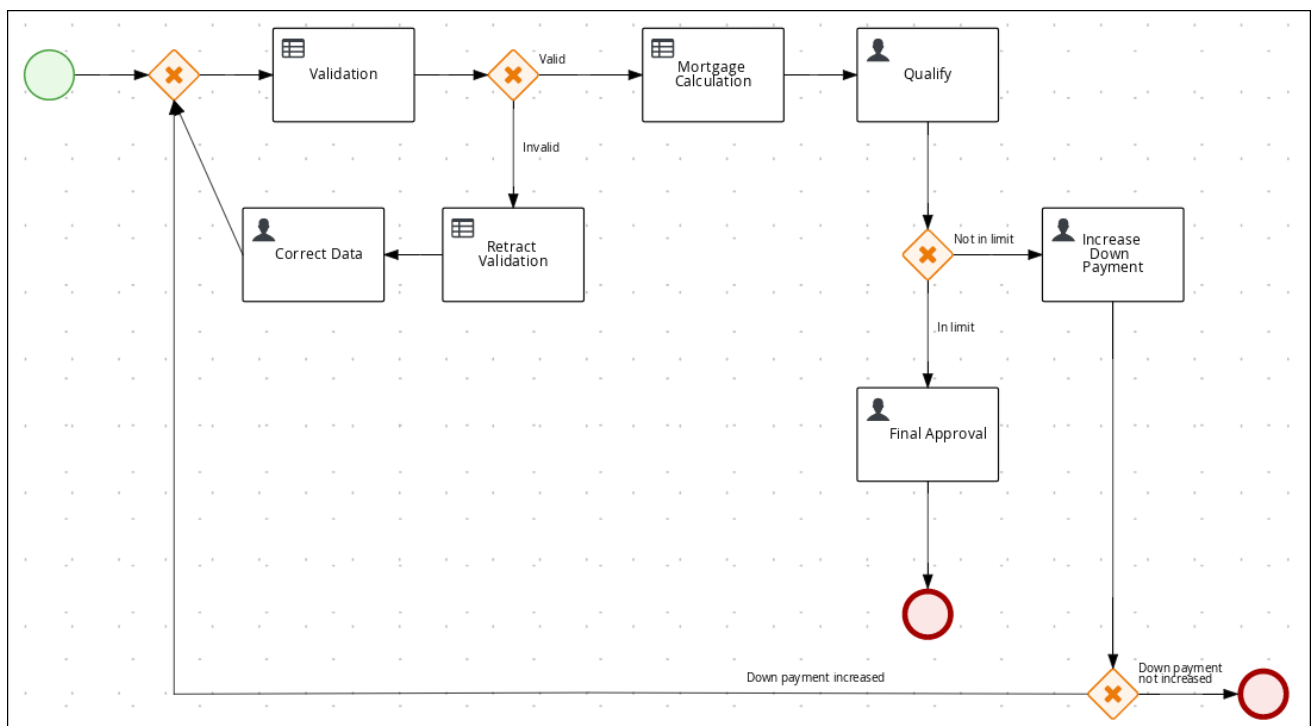

CHAPTER 16. GUIDED RULES

Guided rules are business rules that you create in a UI-based guided rules designer in Business Central that leads you through the rule-creation process. The guided rules designer provides fields and options for acceptable input based on the data objects for the rule being defined. The guided rules that you define are compiled into Drools Rule Language (DRL) rules as with all other rule assets.

All data objects related to a guided rule must be in the same project package as the guided rule. Assets in the same package are imported by default. After you create the necessary data objects and the guided rule, you can use the **Data Objects** tab of the guided rules designer to verify that all required data objects are listed or to import other existing data objects by adding a **New item**.

16.1. VIEWING THE MORTGAGE_PROCESS BUSINESS RULES

The goal of this chapter is to introduce you to the predefined business rules for the **Mortgage_Process** project. For this tutorial, you do not create and define the business rules. Instead, review the **WHEN** and **THEN** rules that are already defined in the **Mortgage_Process** sample project's preconfigured business rules. For information about creating guided business rules, see [Designing a decision service using guided rules](#).

16.1.1. Viewing the Validate Down Payment guided rule

Review the **WHEN** and **THEN** rules so that you understand how the conditions are set and used later when you run the process.

Procedure

1. Click **Menu** → **Design** → **Projects**, and click **Mortgage_Process**.
2. From the asset list, click the right arrow to view the second page of the asset list and click the **Validate Down Payment** guided rule.
3. Review the **Validate Down Payment** guided rule's **WHEN** and **THEN** conditions and values.

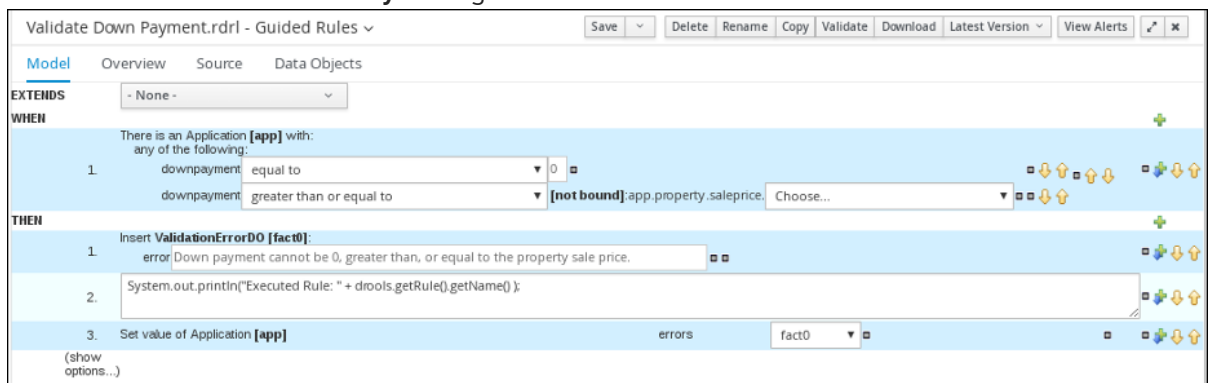

16.1.2. Viewing the RetractValidationErr guided rule

Review the **WHEN** and **THEN** rules so that you understand how the conditions are set and used later when you run the process.

Procedure

1. Click **Menu** → **Design** → **Projects**, and click **Mortgage_Process**.

- From the asset list, click the right arrow to view the second page of the asset list and click the **RetractValidationErr** guided rule.
- Review the **RetractValidationErr** guided rule's **WHEN** and **THEN** conditions and values.

The screenshot displays the configuration interface for the **RetractValidationErr.rdr1** Guided Rule. The interface includes a top navigation bar with tabs for **Model**, **Overview**, **Source**, and **Data Objects**. Below the tabs, there is a dropdown menu for **EXTENDS** set to **- None -**. The **WHEN** section contains a single condition: **1. There is a ValidationErrorDO [vdo]**. The **THEN** section contains a single action: **1. delete ValidationErrorDO [vdo]**. Under the action, there are **Attributes:** **dialect** (set to **mvel**) and **ruleflow-group** (set to **error**). The interface also features a toolbar with buttons for **Save**, **Delete**, **Rename**, **Copy**, **Validate**, **Download**, **Latest Version**, and **View Alerts**.

CHAPTER 17. GUIDED DECISION TABLES

Guided decision tables are a wizard-led alternative to spreadsheet decision tables for defining business rules in a tabular format. With guided decision tables, you are led by a UI-based wizard in Business Central that helps you define rule attributes, metadata, conditions, and actions based on specified data objects in your project. After you create your guided decision tables, the rules you defined are compiled into Drools Rule Language (DRL) rules as with all other rule assets.

All data objects related to a guided decision table must be in the same project package as the guided decision table. Assets in the same package are imported by default. After you create the necessary data objects and the guided decision table, you can use the **Data Objects** tab of the guided decision tables designer to verify that all required data objects are listed or to import other existing data objects by adding a **New item**.

17.1. VIEWING THE MORTGAGE DECISION TABLE

The goal of this chapter is to introduce you to the **MortgageDecisionTable** decision table. For this tutorial, you do not create and set the decision table conditions. Instead, review the values and the conditions that are already defined in the **Mortgage_Process** sample project's **MortgageDecisionTable** Guided Decision Tables asset. For information about creating decision tables, see [Designing a decision service using guided decision tables](#).

Prerequisites

- The business rules have been defined. For more information, see [Section 16.1, "Viewing the Mortgage_Process business rules"](#).

Procedure

- In Business Central, go to **Menu** → **Design** → **Projects** → **Mortgage_Process**.
- Scroll down and click the **MortgageDecisionTable** Guided Decision Tables asset.

| MortgageDecisionTable | | | | | | | | |
|-----------------------|-------------|---------------------|-------------------------|-----------------|------------------|------------|------------|-----------------|
| # | Description | ruleflow-group | Applicant Annual Income | | Property | | | application |
| | | | \$greater | \$less_or_equal | \$saleprice_less | \$age_less | \$location | Mortgage Amount |
| 1 | | mortgagecalculation | 100000 | 200000 | 300000 | 5 | Urban | 200000 |
| 2 | | mortgagecalculation | 50000 | 99999 | 100000 | 10 | Rural | 100000 |

CHAPTER 18. FORMS IN BUSINESS CENTRAL

A form is a layout definition for a page, defined as HTML, that is displayed as a dialog window to the user during process and task instantiation. Task forms acquire data from a user for both the process and task instance execution, whereas process forms take input and output from process variables.

The input is then mapped to the task using the data input assignment, which you can use inside of a task. When the task is completed, the data is mapped as a data output assignment to provide the data to the parent process instance.

18.1. VIEWING THE MORTGAGE_PROCESS FORMS

The goal of this chapter is to introduce you to the **Mortgage_Process** sample project's predefined forms which are used for collecting user data for the mortgage application business process. For this tutorial, you do not create and modify the **Mortgage_Process** forms. Instead, review the predefined sample forms. For information about creating forms, see [Designing business processes using BPMN models](#).

Procedure

1. In Business Central, go to **Menu → Design → Projects → Mortgage_Process**.
2. From the asset list, click the right arrow to view the second page of the asset list and select the **Applicant** form.

Figure 18.1. Applicant sample form

The screenshot shows the 'Form Modeler' interface for the 'Applicant' form. The title bar includes the text 'Form Modeler [Applicant]' and several action buttons: 'Save', 'Delete', 'Rename', 'Copy', 'Download', 'Latest Version', and 'Hide Alerts'. Below the title bar, there are two tabs: 'Model' (which is selected and underlined) and 'Overview'. The main content area displays three form fields, each with a label and a text input field. The first field is labeled 'Name' and contains the placeholder text 'Name'. The second field is labeled 'Annual Income' and contains the placeholder text 'Annual Income'. The third field is labeled 'SSN' and contains the placeholder text 'SSN'. Each field has a vertical ellipsis menu icon to its right.

3. Click **Menu → Design → Projects → Mortgage_Process**.
4. From the asset list, select the **Property** form. The **Property** form is shown below:

Figure 18.2. Property sample form

Form Modeler [Property] ▾ Save ▾ Delete Rename Copy Download Latest Version ▾ View Alerts [?] [X]

Model Overview

Age of property ⋮
Age of property

Address of property ⋮
Address of property

Locale ⋮
Locale

Sale Price ⋮
Sale Price

5. Click **Menu** → **Design** → **Projects** → **Mortgage_Process**.
6. From the asset list, select the **Application** form. The **Application** form is shown below:

Figure 18.3. Application sample form

Form Modeler [Application] ▾ Save ▾ Delete Rename Copy Download Latest Version ▾ View Alerts [?] [X]

Model Overview

Down Payment ⋮
Down Payment

Years of amortization ⋮
Years of amortization

Applicant ⋮

Name
Name

Annual Income
Annual Income

SSN
SSN

Property ⋮

Age of property
Age of property

Address of property
Address of property

Locale
Locale

Sale Price
Sale Price

7. Click the **X** icon in the upper-right corner to close the editor.

CHAPTER 19. DEPLOYING THE MORTGAGEAPPROVALPROCESS PROCESS APPLICATION

The following chapter instructs you how to build and deploy a new instance of the `Mortgage_Process` application in Red Hat Process Automation Manager.

Prerequisites

- KIE Server is deployed and connected to Business Central.

Procedure

1. In Business Central, go to **Menu** → **Design** → **Projects** → **Mortgage_Process**.
2. Click **Deploy**.
 - If no KIE container (deployment unit) is included with the project name, a container with default values is automatically created.
 - If an older version of the project is already deployed, go to the project settings and change the project version. When finished, save the change and click **Deploy**. This deploys a new version of the same project with the latest changes in place, alongside the older version(s).



NOTE

You can also select the **Build & Install** option to build the project and publish the KJAR file to the configured Maven repository without deploying to a KIE Server. In a development environment, you can click **Deploy** to deploy the built KJAR file to a KIE Server without stopping any running instances (if applicable), or click **Redeploy** to deploy the built KJAR file and replace all instances. The next time you deploy or redeploy the built KJAR, the previous deployment unit (KIE container) is automatically updated in the same target KIE Server. In a production environment, the **Redeploy** option is disabled and you can click **Deploy** only to deploy the built KJAR file to a new deployment unit (KIE container) on a KIE Server.

To configure the KIE Server environment mode, set the `org.kie.server.mode` system property to `org.kie.server.mode=development` or `org.kie.server.mode=production`. To configure the deployment behavior for a corresponding project in Business Central, go to project **Settings** → **General Settings** → **Version** and toggle the **Development Mode** option. By default, KIE Server and all new projects in Business Central are in development mode. You cannot deploy a project with **Development Mode** turned on or with a manually added **SNAPSHOT** version suffix to a KIE Server that is in production mode.

3. To review project deployment details, click **View deployment details** in the deployment banner at the top of the screen or in the **Deploy** drop-down menu. This option directs you to the **Menu** → **Deploy** → **Execution Servers** page.

CHAPTER 20. EXECUTING THE MORTGAGEAPPROVALPROCESS PROCESS APPLICATION

Now that you have deployed the project, you can execute the project's defined functionality. For this tutorial you input data into a mortgage application form acting as the mortgage broker. The **MortgageApprovalProcess** business process runs and determines whether or not the applicant has offered an acceptable down payment based on the decision rules that you defined earlier. The business process either ends the rule testing or requests that the applicant increase the down payment to proceed. If the application passes the business rule testing, the bank's approver reviews the application and either approve or deny the loan.

Prerequisites

- KIE Server is deployed and connected to Business Central.
- The **Mortgage_Process** application has been deployed.
- The users working on the tasks are members of the following groups and roles:
 - **approver** group: For the **Qualify** task
 - **broker** group: For the **Correct Data** and **Increase Down Payment** tasks
 - **manager** role: For the **Final Approval** task

Procedure

1. Log in to Red Hat Process Automation Manager as **Bill** (the broker) and click **Menu → Manage → Process Definitions**.
2. Click the three vertical dots in the **Actions** column and select **Start** to start to open the **Application** form and input the following values in to the form fields:
 - **Down Payment: 30000**
 - **Years of amortization 10**
 - **Name: Ivo**
 - **Annual Income: 60000**
 - **SSN: 123456789**
 - **Age of property: 8**
 - **Address of property: Brno**
 - **Locale: Rural**
 - **Property Sale Price: 50000**
3. Click **Submit** to start a new process instance. After starting the process instance, the **Instance Details** view opens.
4. Click the **Diagram** tab to view the process flow within the process diagram. The state of the process is highlighted as it moves through each task.

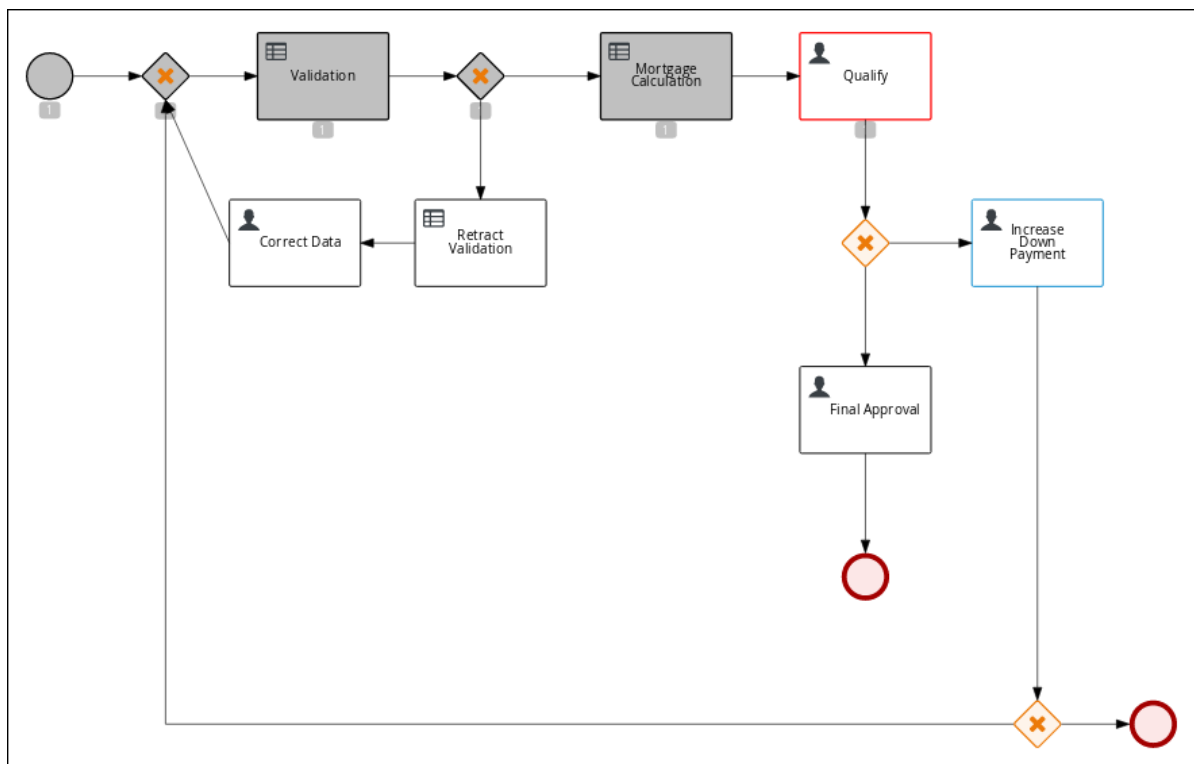

5. Log out of Business Central and log back in as **Katy**.
6. Click **Menu** → **Track** → **Task Inbox**. This takes you to the **Qualify** form.
7. Click the three vertical dots in the **Actions** column and select and click **Claim**. The Qualify task **Status** is now **Reserved**.
8. Click the **Qualify** task row to open and review the task information. Click **Claim** and then **Start** at the bottom of the form.
The application form is now active for approval or denial.
9. To approve the application, select **Is mortgage application in limit?** and click **Complete**.
10. In the **Task Inbox**, click anywhere in the **Final Approval** row to open the **Final Approval** task.
11. In the **Final Approval** row, click the three vertical dots in the **Actions** column and click **Claim**.
12. Click anywhere in the **Final Approval** row to open the **Final Approval** task. Click **Start** at the bottom of the form.
13. Note that the **Inlimit** check box is selected to reflect that that application is ready for final approval. Click **Complete**.



NOTE

The **Save** and **Release** buttons are only used to either pause the approval process and save the instance if you are waiting on a field value, or to release the task for another user to modify.

CHAPTER 21. MONITORING THE MORTGAGEAPPROVALPROCESS PROCESS APPLICATION

The following chapter shows how different bank employees, such as a system administrator or a knowledge worker, might use some of the monitoring capabilities to track an instance of the mortgage approval process.

Prerequisites

- KIE Server is deployed and connected to Business Central.

Procedure

1. Log in to Red Hat Process Automation Manager and click **Menu → Manage → Process Instances**.
2. In the **Manage Process Instances** window, you can set filters, such as **State, Errors, Id**, and so on.
3. Select **Completed** in the **State** filter to view all completed **MortgageApprovalProcess** instances.
4. Click on the completed process instance.
5. Click each of the following tabs to get a feel for what type of information is available to monitor a specific process instance:
 - **Instance Details**
 - **Process Variables**
 - **Documents**
 - **Logs**
 - **Diagram**
6. Click **Menu → Track → Process Reports**. This view contains a variety of charts that can help a senior process manager to gain an overview of all processes based on **Type, Start Date, Running Time**, and so on to assist with task reporting.

21.1. FILTERING PROCESS INSTANCES USING DEFAULT OR ADVANCED FILTERS

Business Central now provides you with default and advanced filters to help you filter and search through running process instances. You can also create custom filters using the **Advanced Filters** option.

21.1.1. Filtering process instances using default filters

Filter process instances by attributes such as **State, Errors, Filter By, Name, Start Date**, and **Last update**.

Procedure

1. In Business Central, go to **Menu → Manage → Process Instances**.
2. On the **Manage Process Instances** page, click the filter icon on the left of the page to expand the **Filters** pane.
This pane lists the following process attributes which you can use to filter process instances:
 - **State:** Filter process instances based on their state (**Active, Aborted, Completed, Pending,** and **Suspended**).
 - **Errors:** Filter process instances by errors.
 - **Filter By:** Filter process instances based on **Id, Initiator, Correlation Key,** or **Description** attribute.
 - i. Select the required attribute.
 - ii. Enter the search query in the text field below.
 - iii. Click **Apply**.
 - **Name:** Filter process instances by definition names.
 - **Definition Id:** Filter process instances by process definition IDs.
 - **Deployment Id:** Filter process instances by process deployment IDs.
 - **Parent Process Instance Id:** Filter process instances by parent process instance IDs.
 - **SLA Compliance:** Filter process instances by SLA compliance states.
 - **Start Date:** Filter process instances by creation dates.
 - **Last update:** Filter process instances by last modified dates.

21.1.2. Filtering process instances using advanced filters

Use the **Advanced Filters** option to create custom process instance filters. The newly created custom filter is added to the **Saved Filters** pane, which is accessible by clicking on the star icon on the left of the **Manage Process Instances** page.

Procedure

1. In Business Central, go to **Menu → Manage → Process Instances**.
2. On the **Manage Process Instances** page, on the left of the page click the **Advanced Filters** icon.
3. In the **Advanced Filters** pane, enter the name and description of the filter, and click **Add New**.
4. Select an attribute from the **Select column** drop-down list, for example, **processName**. The content of the drop-down changes to **processName != value1**.
5. Click the drop-down again and choose the required logical query. For the **processName** attribute, choose **equals to**.
6. Change the value of the text field to the name of the process you want to filter.



NOTE

The name must match the value defined in the business process of the project.

7. Click **Save** and the processes are filtered according to the filter definition.
8. Click the star icon to open the **Saved Filters** pane.
In the **Saved Filters** pane, you can view all the saved advanced filters.

CHAPTER 22. ADDITIONAL RESOURCES

- *Designing business processes using BPMN models*

PART III. GETTING STARTED WITH CASE MANAGEMENT IN RED HAT PROCESS AUTOMATION MANAGER

As a business rules and processes developer, you can use case management assets in Business Central to create unpredictable and ad hoc case processes. Case workers or process administrators can also use Business Central for case management and execution. Red Hat Process Automation Manager provides example projects with example business assets in Business Central as a reference. This document describes how to create and test an example IT orders project based on the **IT_Orders** sample project included in Business Central.

Prerequisites

- Red Hat JBoss Enterprise Application Platform 7.3 is installed. For installation information, see [Red Hat JBoss Enterprise Application Platform 7.3 Installation Guide](#) .
- Red Hat Process Automation Manager is installed and configured with KIE Server. For more information see [Installing and configuring Red Hat Process Automation Manager on Red Hat JBoss EAP 7.3](#).
- Red Hat Process Automation Manager is running and you can log in to Business Central with the **kie-server**, **user**, and **admin** roles.
- You have reviewed the information in [Designing and building cases for case management](#) .

CHAPTER 23. REVIEWING THE IT_ORDERS SAMPLE PROJECT

Before you create your own case management project, review the existing **IT_Orders** sample case management project in Business Central. This sample project contains predefined case management assets as a reference for your own case projects.



IMPORTANT

The business process application example includes features that are Technology Preview only. Technology Preview features are not supported with Red Hat production service level agreements (SLAs), might not be functionally complete, and are not recommended for production. These features provide early access to upcoming product features, enabling customers to test functionality and provide feedback during the development process. For more information about Red Hat Technology Preview support, see [Technology Preview Features Support Scope](#).

Procedure

1. In Business Central, go to **Menu → Design → Projects**. If there are existing projects, you can access the samples by clicking the **MySpace** default space and selecting **Try Samples** from the **Add Project** drop-down menu. If there are no existing projects, click **Try samples**.
2. Select **IT_Orders** and click **Ok**.

The **Assets** view of the project opens. Select each example asset to explore how the project is designed to achieve the specified goal or workflow.

Review the **orderhardware** business process to help you understand the business process flow.

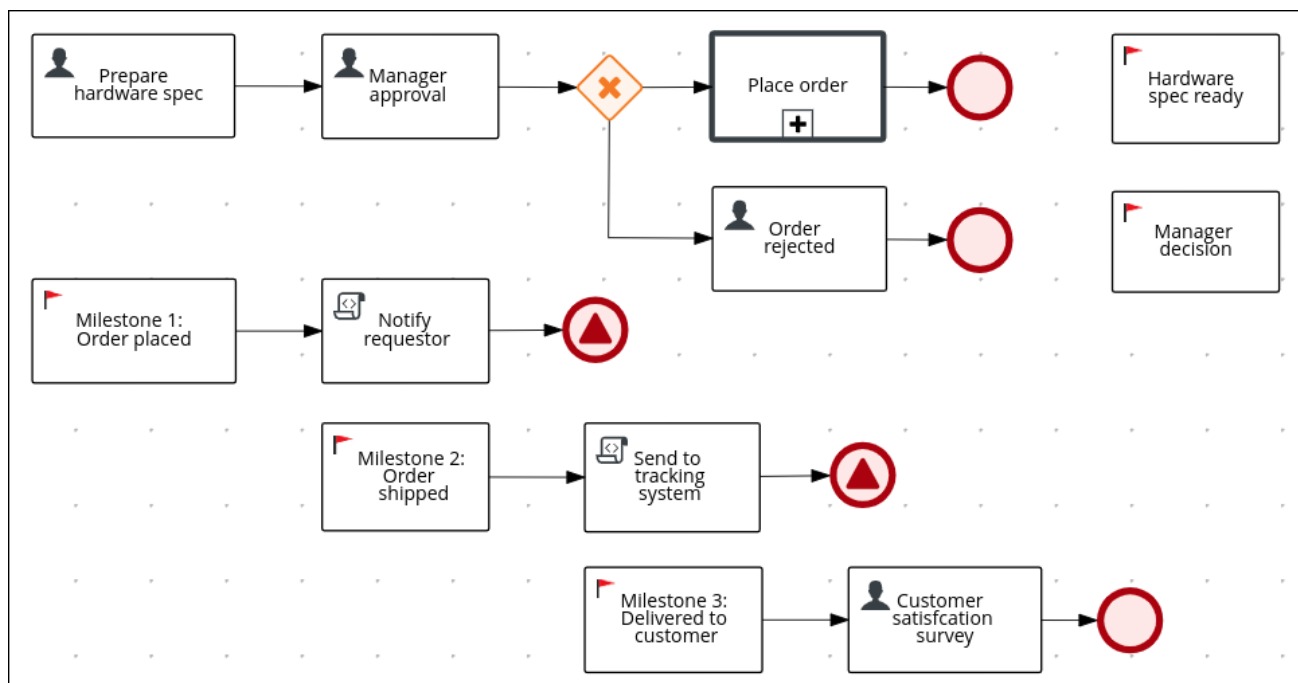

CHAPTER 24. CREATING A NEW IT_ORDERS CASE PROJECT

Create a new **IT_Orders** project in Business Central to gain an understanding of all of the required assets and how they are used in the project.

Procedure

1. Log in to Business Central and go to **Menu** → **Design** → **Projects**.
Business Central provides a default space called **MySpace**, as shown in the following image. You can use the default space to create and test example projects.

Figure 24.1. Default spaces

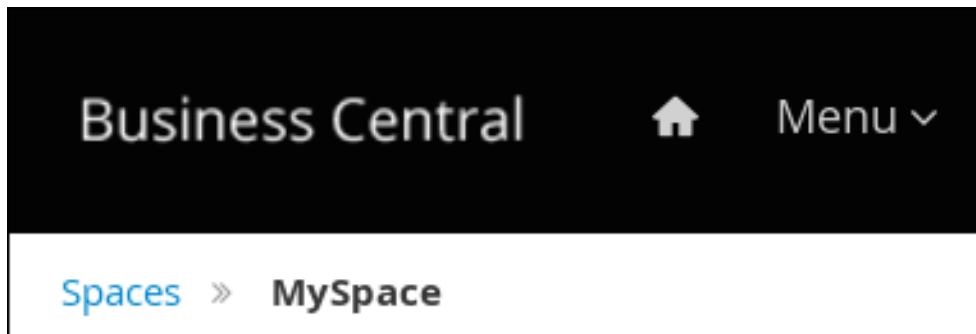

2. Click the **Add Project** drop-down arrow and select the **Case project** option:

Figure 24.2. Case project

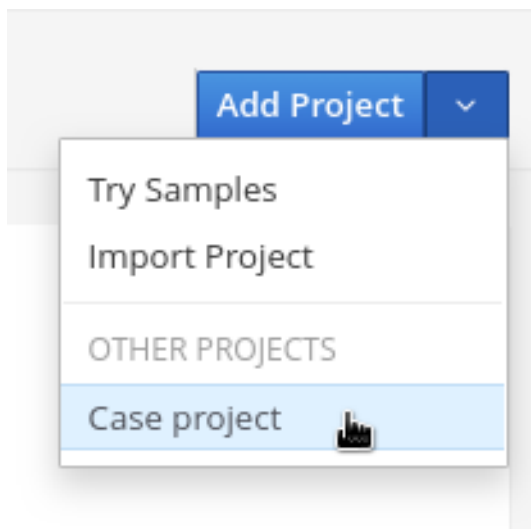

3. In the **Add Project** window, enter **IT_Orders_New** in the **Name** field and enter a project **Description**.

Figure 24.3. Add Project window

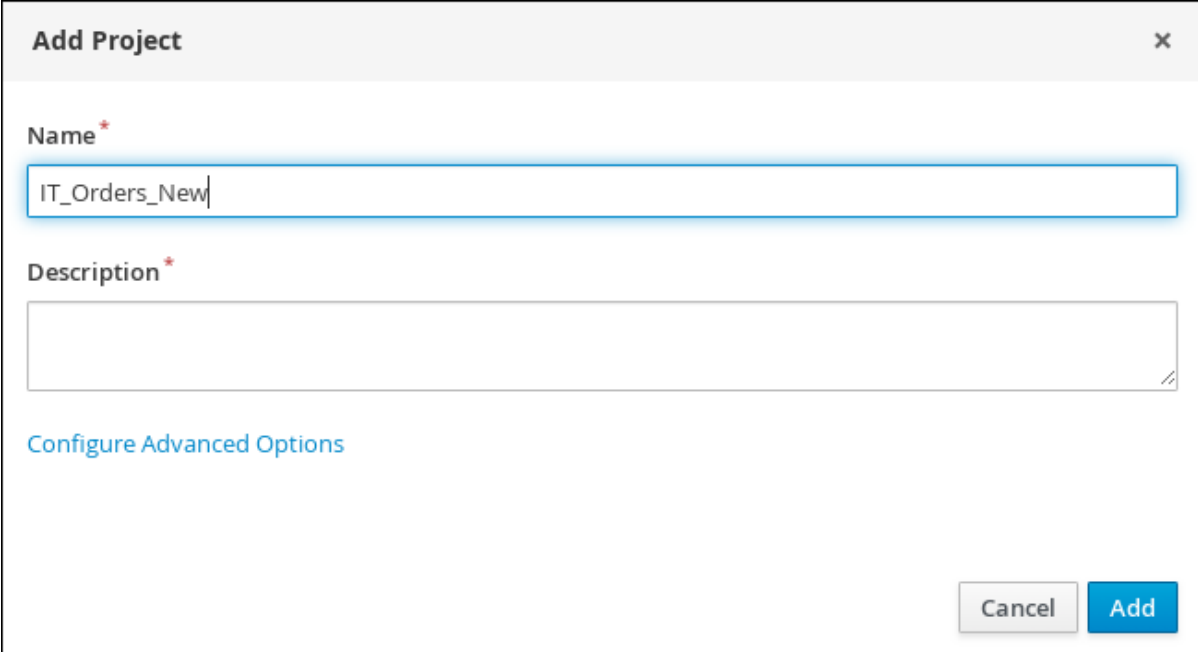

Add Project ×

Name *

IT_Orders_New

Description *

[Configure Advanced Options](#)

Cancel Add

4. Click **Add** to add the project.
The **Assets** view of the project opens.

CHAPTER 25. DATA OBJECTS

Data objects are the building blocks for the rule assets that you create. Data objects are custom data types implemented as Java objects in specified packages of your project. For example, you might create a **Person** object with data fields **Name**, **Address**, and **DateOfBirth** to specify personal details for loan application rules. These custom data types determine what data your assets and your decision services are based on.

25.1. CREATING THE ITORDERSERVICE DATA OBJECT

The **ITOrderService** data object specifies the data type that will be used to define the IT Orders variables.

Prerequisites

- The **IT_Orders_New** project is created.

Procedure

1. Click **Add Asset** → **Data Object**.
2. In the Create new Data Object wizard, enter the following values:
 - Data Object: **ITOrderService**
 - Package: **com.myspace.it_orders_new**
3. Click **Ok**.
4. Click  next to the **Package** drop-down menu to specify a new package for the data object.
5. Input **org.jbpm.demo.it_orders.services** and click **Add**.
6. Click **Save**, and then click **Yes, Move** to confirm your changes.

25.2. CREATING THE SURVEY DATA OBJECT

The **Survey** data object contains data fields, such as **deliveredOnTime** and **missingEquipment**. You will use the data and values when you design your case.

Prerequisites

- The **IT_Orders_New** project is created.

Procedure

1. In Business Central, go to **Menu** → **Design** → **Projects** and click **IT_Orders_New**.
2. Click **Add Asset** → **Data Object**.
3. In the **Create new Data Object** wizard, enter the following values:
 - Data Object: **Survey**

- Package: **com.myspace.it_orders_new**
4. Click **Ok**.
 5. Add the **Survey** data object constraints.
 - a. Click **add field**.
 - b. Enter the following values:
 - **Id: comment**
 - **Label:** Leave empty
 - **Type: String**
 - c. Click **Create and continue**, and then enter the following values:
 - **Id: deliveredOnTime**
 - **Label:** Leave empty
 - **Type: Boolean**
 - d. Click **Create and continue**, and then enter the following values:
 - **Id: missingEquipment**
 - **Label:** Leave empty
 - **Type: String**
 - e. Click **Create and continue**, and then enter the following values:
 - **Id: satisfied**
 - **Label:** Leave empty
 - **Type: Boolean**
 - f. Click **Create**.
 6. Click **Save** to confirm your changes.

Figure 25.1. Survey data object details

The screenshot shows the 'Survey' data object details in an IDE. The interface is divided into two main sections: a table of fields and a 'Survey'- general properties panel.

Fields Table:

| Identifier | Label | Type | |
|------------------|-------|---------|--------|
| comment | | String | Delete |
| deliveredOnTime | | Boolean | Delete |
| missingEquipment | | String | Delete |
| satisfied | | Boolean | Delete |

'Survey'- general properties:

- Identifier: Survey
- Label: (empty)
- Description: (empty)
- Package: com.myspace.it_orders_new
- Superclass: java.lang.Object

CHAPTER 26. DESIGNING THE CASE DEFINITION

You design cases using the process designer in Business Central. Case design is the basis of case management and sets the specific goals and tasks for each case. The case flow can be modified dynamically during run time by adding dynamic tasks or processes. In this procedure, you will create this same case definition to familiarize yourself with the case definition design process.

The **IT_Orders** sample project in Business Central includes the following **orderhardware** business process case definition.

Figure 26.1. orderhardware business process case definition

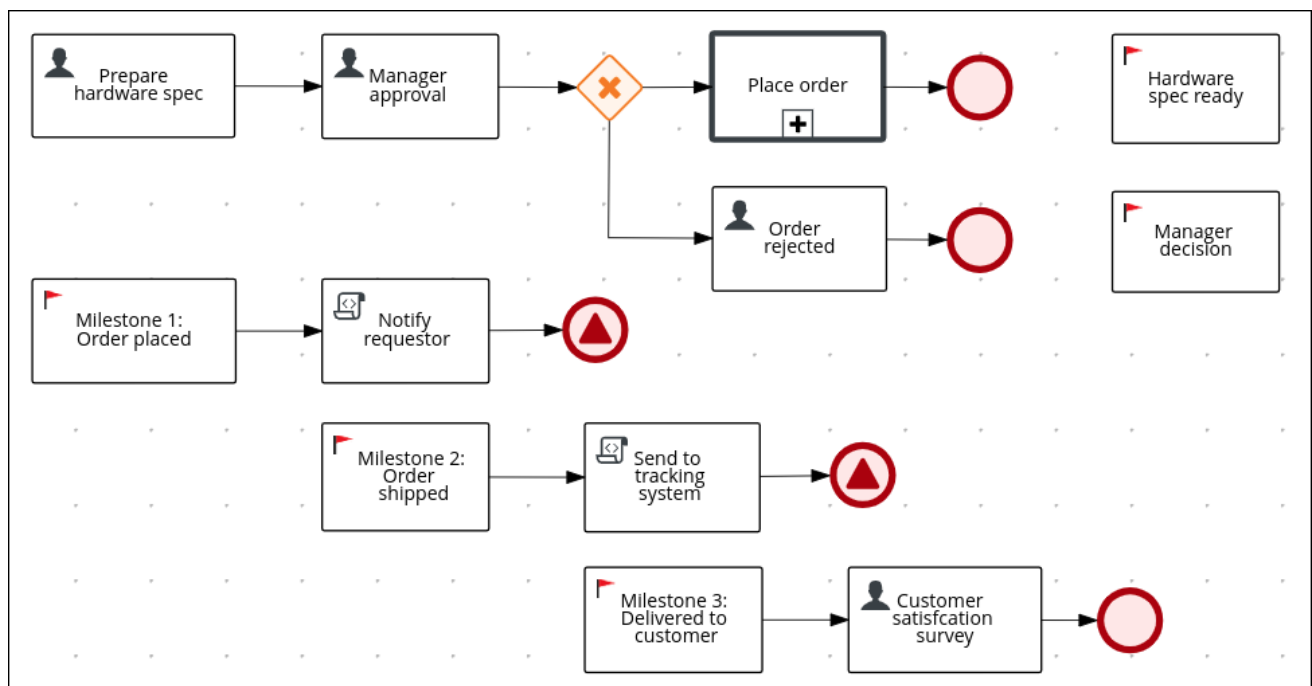

Prerequisites

- You have created a new case in Business Central. For more information, see [Chapter 24, Creating a new IT_Orders case project](#).
- You have created the data objects. For more information, see [Chapter 25, Data objects](#).

Procedure

1. In Business Central, go to **Menu → Design → Projects** and click **IT_Orders_New**.
2. Click **Add Asset → Case Definition**.
3. In the **Create new Case definition** window, add the following required information:
 - **Case Definition:** Input **orderhardware**. This is usually the subject of the case or project that is being case managed.
 - **Package:** Select **com.myspace.it_orders_new** to specify the location that the case file is created in.
4. Click **Ok** to open the process designer.

5. Define values for the case file variables that are accessible to the sub-processes, subcases, and business rules used in the case.
 - a. In the upper-right corner, click the **Properties**  icon.

















- b. Scroll down and expand **Case Management**, click  in the **Case File Variables** section, and enter the following:

Figure 26.2. orderhardware case file variables

| Case File Variables  | | |
|---|---|---|
| Name | Data Type |  |
| hwSpec | org.jbpm.document.Do  |  |
| managerComment | String  |  |
| supplierComment | String  |  |
| managerDecision | Boolean  |  |
| survey | Survey [org.jbpm.demo  |  |
| shipped | Boolean  |  |
| delivered | Boolean  |  |



NOTE

The following case file variables are custom data types:

- **hwSpec**: org.jbpm.document.Document (type in this value)
- **survey**: Survey [com.myspace.it_orders_new] (select this value)



6. Click **Save**.
7. Define the roles involved in the case.
 - a. In the upper-right corner, click the **Properties**  icon.
 - b. Scroll down and expand **Case Management**, click  in the **Case Roles** section, and enter the following:

Figure 26.3. orderhardware case roles

| Case Roles | | |
|------------|-------------|----|
| Name | Cardinality | + |
| owner | 1 | 🗑️ |
| manager | 1 | 🗑️ |
| supplier | 2 | 🗑️ |

- **owner:** The employee who is making the hardware order request. The role cardinality is set to **1**, which means that only one person or group can be assigned to this role.
- **manager:** The employee's manager; the person who will approve or deny the requested hardware. The role cardinality is set to **1**, which means that only one person or group can be assigned to this role.
- **supplier:** The available suppliers of IT hardware in the system. The role cardinality is set to **2**, which means that more than one supplier can be assigned to this role.

8. Click **Save**.

26.1. CREATING THE PLACE ORDER SUB-PROCESS

Create the **Place order** sub-process, which is a separate business process that is carried out by the supplier. This is a reusable process that occurs during the course of case execution as described in [Chapter 26, Designing the case definition](#).

















Prerequisites

- You have created a new case in Business Central. For more information, see [Chapter 24, Creating a new IT_Orders case project](#).
- You have created the data objects. For more information, see [Chapter 25, Data objects](#).

Procedure

1. In Business Central, go to **Menu** → **Design** → **Projects** → **IT_Orders_New**.
2. From the project menu, click **Add Asset** → **Business Process**.
3. In the **Create new Business Process** wizard, enter the following values:
 - **Business Process:** **place-order**
 - **Package:** Select **com.myspace.it_orders_new**
4. Click **Ok**. The diagram editor opens.
5. Click an empty space in the canvas, and in the upper-right corner, click the **Properties**  icon.

6. Scroll down and expand **Process Data** and click  in the **Process Variables** section and enter the following:

| Process Data | | | |
|-------------------|----------------|---|---|
| Process Variables | | | |
| Name | Data Type | Tags ⓘ | + |
| CaseId | String ▼ |  |  |
| Requestor | String ▼ |  |  |
| _hwSpec | org.jbpm.doc ▼ |  |  |
| ordered_ | Boolean ▼ |  |  |
| info_ | String ▼ |  |  |
| caseFile_hwSpec | org.jbpm.doc ▼ |  |  |
| caseFile-ordered | Boolean ▼ |  |  |
| caseFile_OrderInf | String ▼ |  |  |

7. Click **Save**.
8. Drag a start event onto the canvas and create an outgoing connection from the start event to a task and convert the new task to a user task.

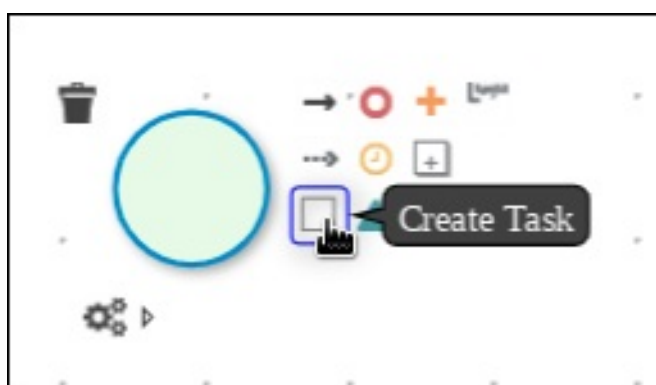
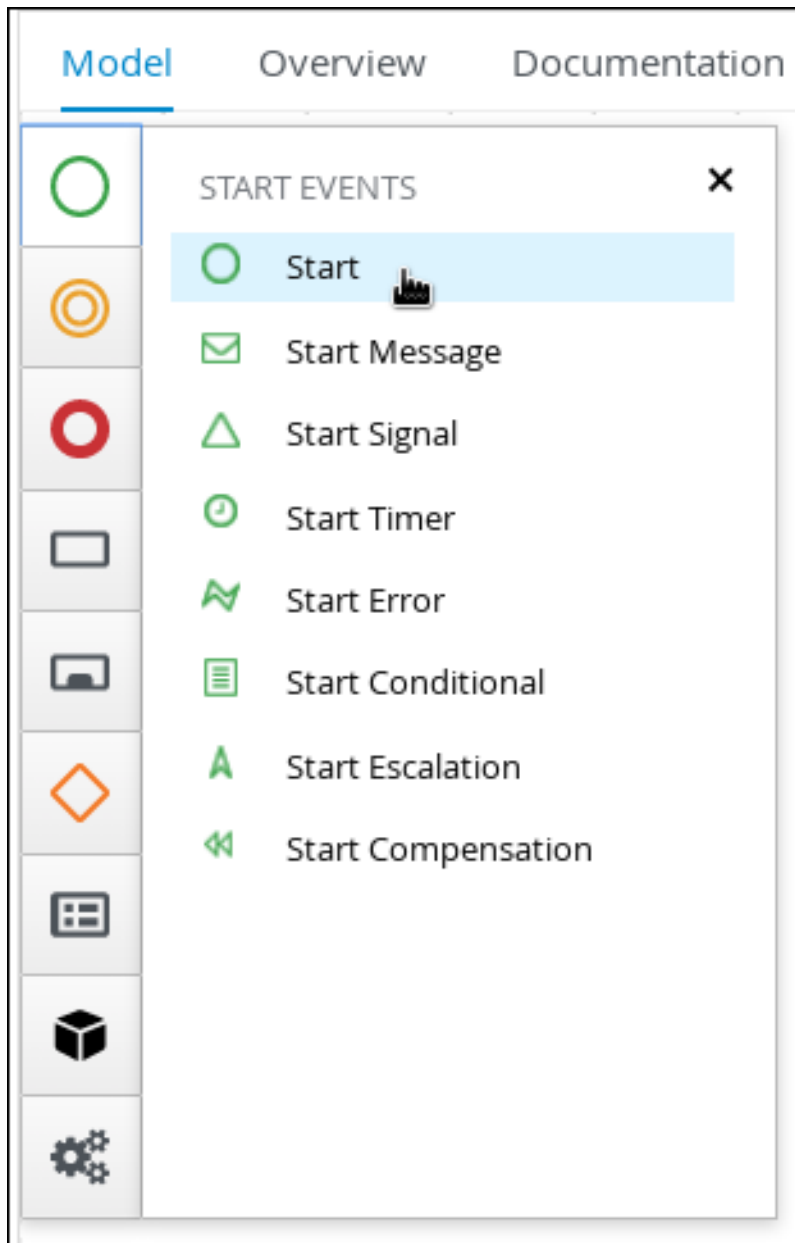

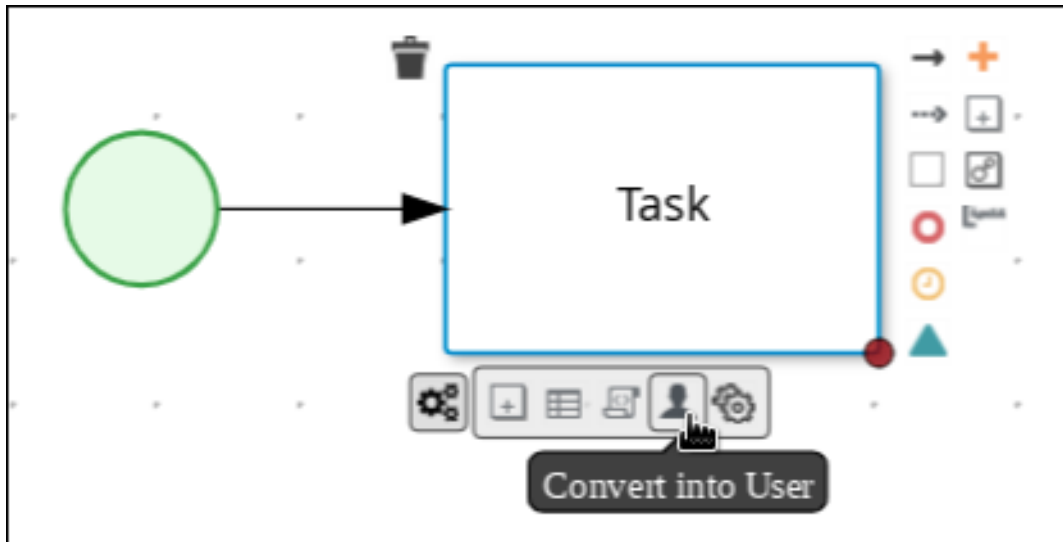





9. Click the user task and in the **Properties** panel, input **Place order** in the **Name** field.
10. Expand **Implementation/Execution**, click **Add** below the **Groups** menu, click **Select** → **New**, and input **supplier**.
11. Click  in the **Assignments** field and add the following:

Place order Data I/O ✕

Data Inputs and Assignments + Add

| Name | Data Type | Source i | |
|--|--------------------|---|---|
| <input type="text" value="_hwSpec"/> | org.jbpm.documer ▼ | caseFile_hwSpec ▼ |  |
| <input type="text" value="orderNumber"/> | String ▼ | CaseId ▼ |  |
| <input type="text" value="requestor"/> | String ▼ | Requestor ▼ |  |

Data Outputs and Assignments + Add

| Name | Data Type | Target i | |
|---------------------------------------|-----------|---|---|
| <input type="text" value="ordered_"/> | Boolean ▼ | caseFile_ordered ▼ |  |
| <input type="text" value="info_"/> | String ▼ | caseFile_orderInfo ▼ |  |

Cancel OK

For the first input assignment, select **Custom** for the **Data Type** and input **org.jbpm.document.Document**.

12. Click **OK**.
13. Select the **Skippable** check box and enter the following text in the **Description** field:
Approved order #{CaseId} to be placed

Skippable

Priority

Description

Approved order #{CaseId} to be placed

14. Create an outgoing connection from the **Place order** user task and connect it to an end event.

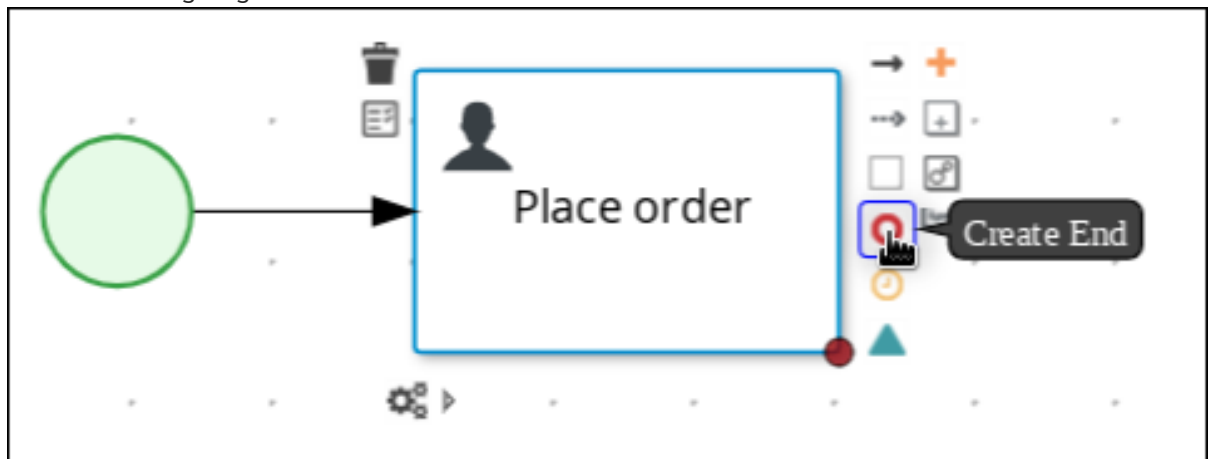

15. Click **Save** to confirm your changes.

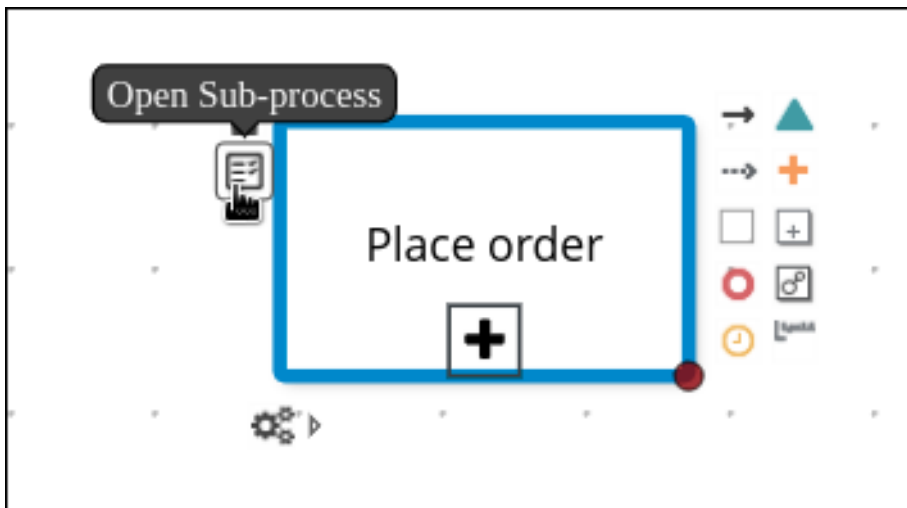

You can open the sub-process in a new editor in Business Central by clicking the **Place order** task in the main process and then clicking the **Open Sub-process** task icon.



26.2. CREATING THE MANAGER APPROVAL BUSINESS PROCESS

The manager approval process determines whether or not the order will be placed or rejected.

Procedure

1. In Business Central, go to **Menu** → **Design** → **Projects** → **IT_Orders_New** → **orderhardware Business Processes**.
2. Create and configure the **Prepare hardware spec** user task:
 - a. Expand **Tasks** in the **Object Library** and drag a user task onto the canvas and convert the new task to a user task.
 - b. Click the new user task and in the upper-right corner click the **Properties**  icon.
 - c. Input **Prepare hardware spec** in the **Name** field.
 - d. Expand **Implementation/Execution**, click **Add** below the **Groups** menu, click **Select** → **New**, and input **supplier**.
 - e. Input **PrepareHardwareSpec** in the **Task Name** field.
 - f. Select the **Skippable** check box and enter the following text in the **Description** field:
Prepare hardware specification for #{initiator} (order number #{Caseld})
 - g. Click  in the **Assignments** field and add the following:

Prepare hardware spec Data I/O
✕



Data Inputs and Assignments + Add

| Name | Data Type | Source i | |
|--|-----------|---|---|
| <input type="text" value="orderNumber"/> | String ▼ | CaseId ▼ | ✕ |
| <input type="text" value="requestor"/> | String ▼ | initiator ▼ | ✕ |

Data Outputs and Assignments + Add

| Name | Data Type | Target i | |
|---|--------------------|---|---|
| <input type="text" value="hwSpec_"/> | org.jbpm.documer ▼ | caseFile_hwSpec ▼ | ✕ |
| <input type="text" value="supplierComment_"/> | String ▼ | caseFile_supplierC ▼ | ✕ |

Cancel OK

- h. Click **OK**.
3. Create and configure the manager approval user task:
 - a. Click the **Prepare hardware spec** user task and create a new user task.
 - b. Click the new user task and in the upper-right corner click the **Properties**  icon.
 - c. Click the user task and in the **Properties** panel input **Manager approval** in the **Name** field.
 - d. Expand **Implementation/Execution**, click **Add** below the **Actors** menu, click **Select** → **New**, and input **manager**.
 - e. Input **ManagerApproval** in the **Task Name** field.
 - f. Click  in the **Assignments** field and add the following:

Manager approval Data I/O x

Data Inputs and Assignments + Add

| Name | Data Type | Source i | |
|--|--------------------|---|--|
| <input type="text" value="_hwSpec"/> | org.jbpm.documer ▼ | caseFile_hwSpec ▼ | |
| <input type="text" value="orderNumber"/> | String ▼ | CaseId ▼ | |
| <input type="text" value="requestor"/> | String ▼ | initiator ▼ | |

Data Outputs and Assignments + Add

| Name | Data Type | Target i | |
|--|-----------|---|--|
| <input type="text" value="approved_"/> | Boolean ▼ | approved ▼ | |
| <input type="text" value="managerComment_"/> | String ▼ | caseFile_manager(▼ | |

Cancel OK

- g. Click **OK**.
 - h. Select the **Skippable** check box and enter the following text in the **Description** field:
Approval request for new hardware for #{initiator} (order number #{CaseId})
 - i. Enter the following Java expression in the **On Exit Action** field:
kcontext.setVariable("caseFile_managerDecision", approved);
 - j. Click **Save**.
4. Click the **Manager approval** user task and create a Data-based Exclusive (XOR) gateway.

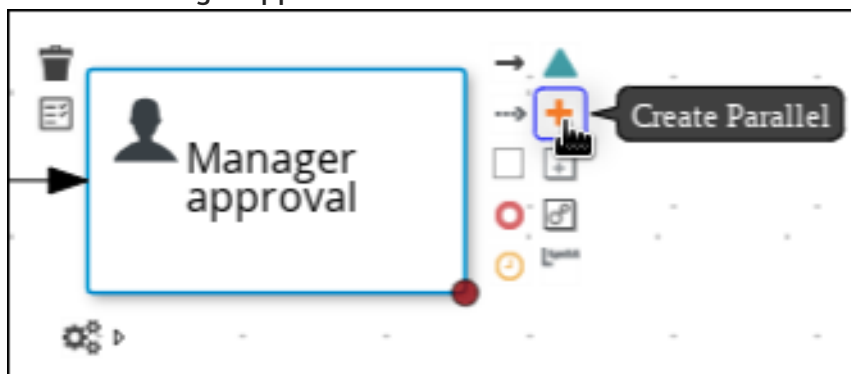

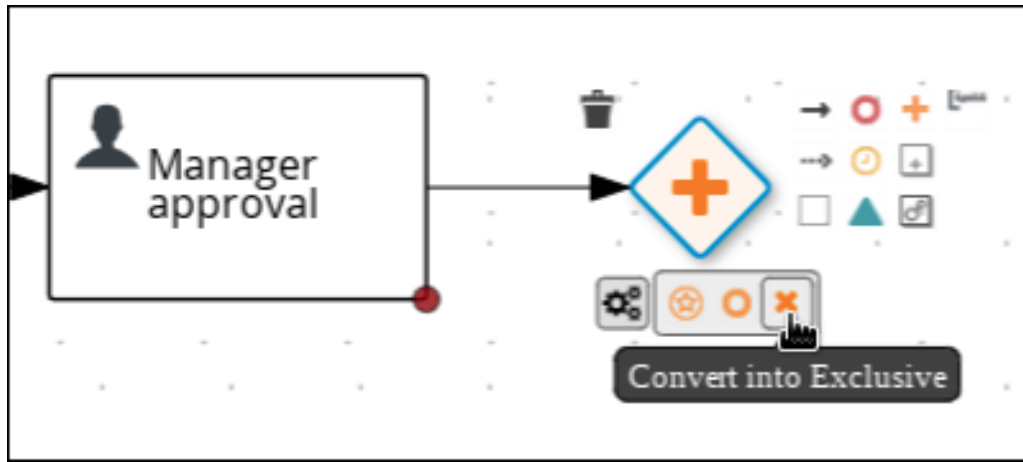

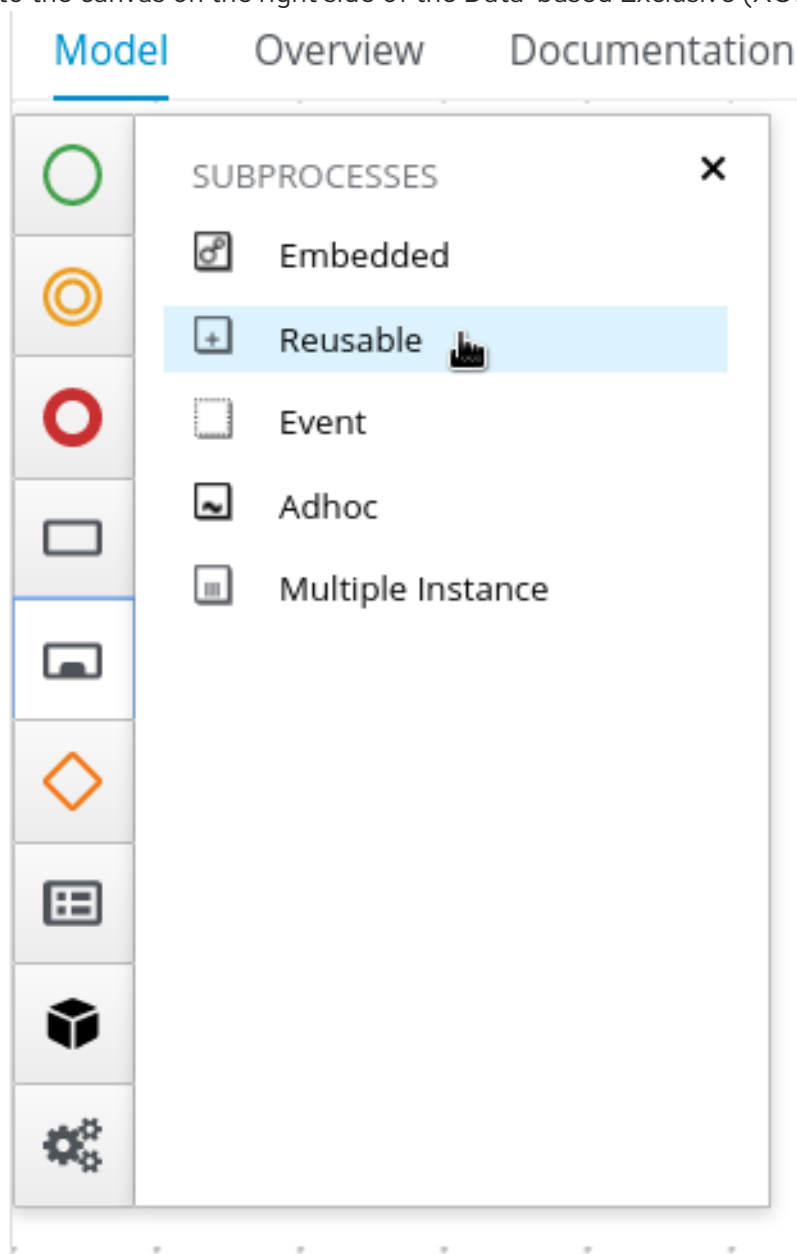

5. Create and configure the **Place order** reusable sub-process:
 - a. From the **Object Library**, expand **sub-processes**, click **Reusable**, and drag the new element to the canvas on the right side of the Data-based Exclusive (XOR) gateway.



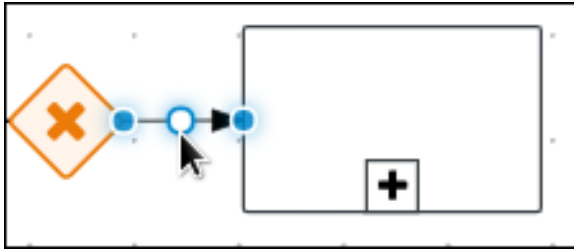

- b. Connect the Data-based Exclusive (XOR) gateway to the sub-process.



- c. Click the new sub task and in the upper-right corner click the **Properties**  icon.
- d. Input **Place order** in the **Name** field.
- e. Expand **Data Assignments** and click  in the **Assignments** field and add the following:

Task Data I/O ✕

Data Inputs and Assignments + Add

| Name | Data Type | Source i | |
|--|-----------|---|---|
| <input type="text" value="CaseId"/> | String ▼ | CaseId ▼ |  |
| <input type="text" value="Requestor"/> | String ▼ | initiator ▼ |  |

Data Outputs and Assignments + Add

- f. Click **OK**.
- g. Click the connection from the Data-based Exclusive (XOR) gateway to the sub-process and click the **Properties**  icon.
- h. Expand **Implementation/Execution**, select **Condition**, and set the following condition expressions.

▼ Implementation/Execution

Priority

Condition Expression



Condition Expression

Process Variable i

Condition i

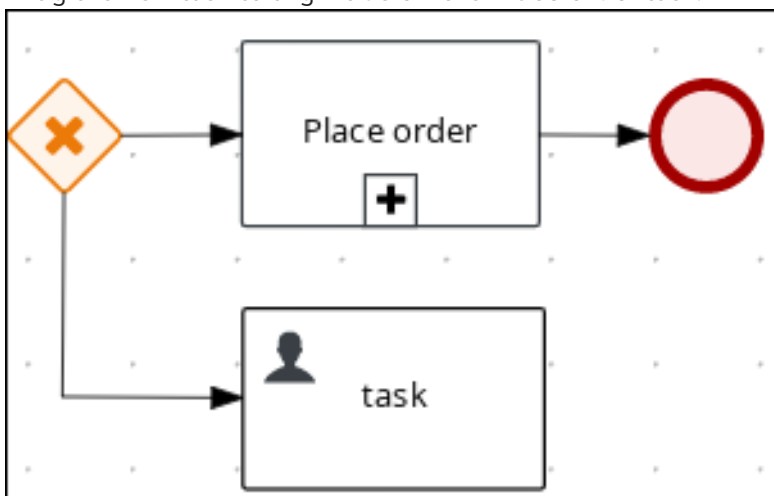
- i. Click the **Place order** user task and create an end event.
6. Create and configure the order rejected user task:
- a. Click the Data-based Exclusive (XOR) gateway and create a new user task.
 - b. Drag the new task to align it below the **Place order** task.



- c. Click the new user task and in the upper-right corner click the **Properties**  icon.
- d. Input **Order rejected** in the **Name** field.
- e. Expand **Implementation/Execution** and input **OrderRejected** in the **Task Name** field.
- f. Click **Add** below the **Actors** menu, click **Select** → **New**, and input **owner**.
- g. Click  in the **Assignments** field and add the following:

Order rejected Data I/O X

Data Inputs and Assignments + Add

| Name | Data Type | Source ? | |
|---|-----------|---|--|
| <input type="text" value="_reason"/> | String ▼ | caseFile_managerC ▼ | |
| <input type="text" value="_supplierComment"/> | String ▼ | caseFile_supplierC ▼ | |

Data Outputs and Assignments + Add

Cancel OK

- h. Click **OK**.
 - i. Select the **Skippable** check box and enter the following text in the **Description** field:
Order #{Caseld} has been rejected by manager
 - j. Click the **Order rejected** user task and create an end event.
 - k. Click **Save**.
7. Click the connection from the Data-based Exclusive (XOR) gateway to the **Order rejected** user task and click the **Properties** icon.
 8. Expand **Implementation/Execution**, select **Condition**, and set the following condition expressions.

▼ **Implementation/Execution**

Priority

Condition Expression

Condition Expression

Process Variable ?

Condition ?

9. Click **Save**.

Figure 26.4. Manager approval business process

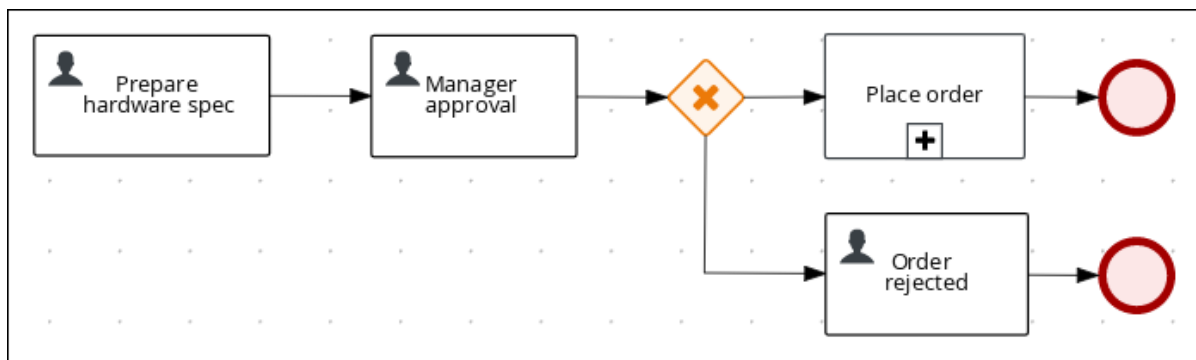

CHAPTER 27. MILESTONES

Milestones are a special service task that can be configured in the case definition designer by adding the milestone node to the process designer palette. When creating a new case definition, a milestone configured as **AdHoc Autostart** is included on the design palette by default. Newly created milestones are not set to **AdHoc Autostart** by default.

Case management milestones generally occur at the end of a stage, but they can also be the result of achieving other milestones. A milestone always requires a condition to be defined in order to track progress. Milestones react to case file data when data is added to a case. A milestone represents a single point of achievement within the case instance. It can be used to flag certain events, which can be useful for Key Performance Indicator (KPI) tracking or identifying the tasks that are still to be completed.

Milestones can be in any of the following states during case execution:



- **Active:** The condition has been defined on the milestone but it has not been met.
- **Completed:** The milestone condition has been met, the milestone has been achieved, and the case can proceed to the next task.
- **Terminated:** The milestone is no longer a part of the case process and is no longer required.

While a milestone is available or completed it can be triggered manually by a signal or automatically if **AdHoc Autostart** is configured when a case instance starts. Milestones can be triggered as many times as required, however, it is directly achieved when the condition is met.

27.1. CREATING THE HARDWARE SPEC READY MILESTONE

Create a **HardwareSpecReady** milestone that is reached when the required hardware specification document is completed.

Procedure

1. In the process designer, expand **Milestone** in the **Object Library** and drag a new milestone on the canvas and place it on the right side of the **Place order** end event.
2. Click the new milestone and in the upper-right corner click the **Properties**  icon.
3. Input **Hardware spec ready** in the **Name** field.
4. Expand **Implementation/Execution** and select **AdHoc Autostart**.
5. Expand **Data Assignments**, click  in the **Assignments** field, and add the following:

Hardware spec ready Data I/O [X]

Data Inputs and Assignments [Add]

| Name | Data Type | Source <i>i</i> | |
|-----------|-----------|-------------------|---------|
| Condition | String ▼ | "org.kie.ap..." ▼ | [Trash] |

Data Outputs and Assignments [Add]

[Cancel] [OK]



Click the **Source** column drop-down, select **Constant**, and input **org.kie.api.runtime.process.CaseData(data.get("hwSpec")) != null**.

6. Click **OK**.

27.2. CREATING THE MANAGER DECISION MILESTONE

This milestone is reached when the **managerDecision** variable has been given a response.

Procedure

1. In the process designer, expand **Milestone** in the **Object Library** and drag a new milestone onto the canvas below the **HardwareSpecReady** milestone.
2. Click the new milestone and in the upper-right corner click the **Properties**  icon.
3. Input **Manager decision** in the **Name** field.
4. Expand **Implementation/Execution** and select **AdHoc Autostart**.
5. Expand **Data Assignments** and click  in the **Assignments** field and add the following:

Manager decision Data I/O [X]

Data Inputs and Assignments [Add]

| Name | Data Type | Source <i>i</i> | |
|-----------|-----------|-------------------|---------|
| Condition | String ▼ | "org.kie.ap..." ▼ | [Trash] |

Data Outputs and Assignments [Add]

[Cancel] [OK]



Click the **Source** column drop-down, select **Constant**, and input **`org.kie.api.runtime.process.CaseData(data.get("managerDecision")) != null`**.

6. Click **OK**.

27.3. CREATING THE ORDER PLACED MILESTONE

This milestone is reached when the **ordered** variable, which is part of the **Place order** sub-process, has been given a response.

Procedure

1. In the process designer, expand **Milestone** in the **Object Library** and drag a new milestone on the canvas below the **Prepare hardware specuser** task.
2. Click the new milestone and in the upper-right corner click the **Properties**  icon.
3. Input **Milestone 1: Order placed** in the **Name** field.
4. Expand **Implementation/Execution** and select **AdHoc Autostart**.
5. Expand **Data Assignments**, click  in the **Assignments** field, and add the following:

Milestone 1: Order placed Data I/O x

Data Inputs and Assignments + Add

| Name | Data Type | Source i | |
|-----------|-----------|---|----|
| Condition | String ▼ | "org.kie.ap..." ▼ | 🗑️ |

Data Outputs and Assignments + Add

Cancel OK

Click the **Source** column drop-down, select **Constant**, and input **`org.kie.api.runtime.process.CaseData(data.get("ordered")) == true`**. This means that a case variable named **ordered** exists with the value **true**.

6. Click **OK**.
7. Click **Milestone 1: Order placed** and create a new script task.
8. Click the new script task and in the upper-right corner click the **Properties**  icon.
9. Input **Notify requestor** in the **Name** field.
10. Expand **Implementation/Execution** and input **`System.out.println("Notification::Order placed");`**;

11. Click the **Notify requestor** script task and create a signal end event.
12. Click the signal event and in the upper-right corner click the **Properties**  icon.
13. Expand **Implementation/Execution**, click the down arrow in the **Signal** field, and select **New**.
14. Input **Milestone 2: Order shipped**.
15. Click the down arrow in the **Signal Scope** field, select **Process Instance**.
16. Click **Save**.



Figure 27.1. Order placed milestone

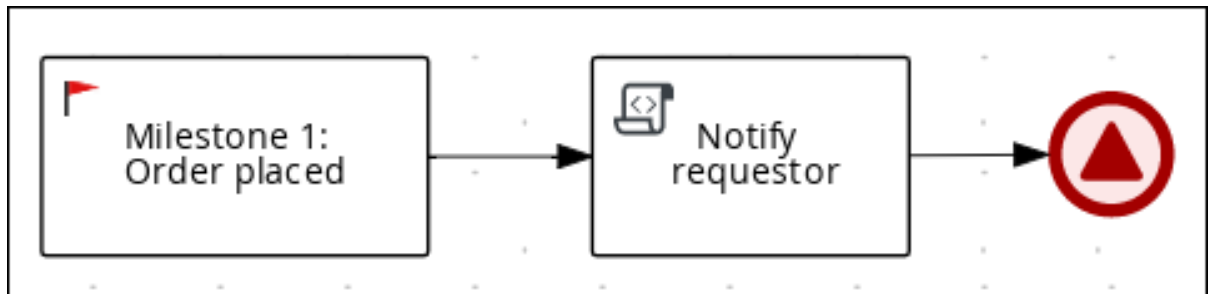

27.4. CREATING THE ORDER SHIPPED MILESTONE

The condition for this milestone is that a case file variable named **shipped** is **true**. **AdHoc Autostart** is not enabled for this milestone. Instead, it is triggered by a signal event when the order is ready to be sent.

Procedure

1. In the process designer, expand **Milestone** in the **Object Library** and drag a new milestone on the canvas below the **Notify requestor** script task.
2. Click the new milestone and in the upper-right corner click the **Properties**  icon.
3. Input **Milestone 2: Order shipped** in the **Name** field.
4. Expand **Implementation/Execution** and ensure that **AdHoc Autostart** is not selected.
5. Expand **Data Assignments**, click  in the **Assignments** field, and add the following:

Milestone 2: Order shipped Data I/O ×

Data Inputs and Assignments + Add

| Name | Data Type | Source i |
|-----------|-----------|---|
| Condition | String ▼ | "org.kie.ap..." ▼ 🗑️ |

Data Outputs and Assignments + Add

Cancel OK

Click the **Source** column drop-down, select **Constant**, and input **org.kie.api.runtime.process.CaseData(data.get("shipped") == true)**. This means that a case variable named **shipped** exists with the value **true**.



6. Click **OK**.
7. Click **Milestone 2: Order shipped** and create a new script task.
8. Click the new script task and in the upper-right corner click the **Properties**  icon.
9. Input **Send to tracking system** in the **Name** field.
10. Expand **Implementation/Execution** and input **System.out.println("Order added to tracking system");**
11. Click the **Send to tracking system** script task and create a signal end event.
12. Click the signal event and in the upper-right corner click the **Properties**  icon.
13. Expand **Implementation/Execution**, click the down arrow in the **Signal** field, and select **New**.
14. Input **Milestone 3: Delivered to customer**.
15. Click the down arrow in the **Signal Scope** field, select **Process Instance**.
16. Click **Save**.



Figure 27.2. Order shipped milestone



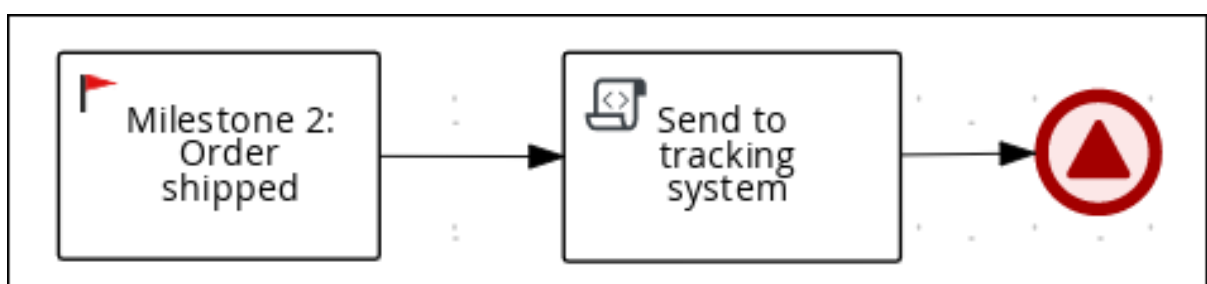

27.5. CREATING THE DELIVERED TO CUSTOMER MILESTONE

The condition for this milestone is that a case file variable named **delivered** is **true**. **AdHoc Autostart** is not enabled for this milestone. Instead, it is triggered by a signal event after the order has successfully shipped to the customer.

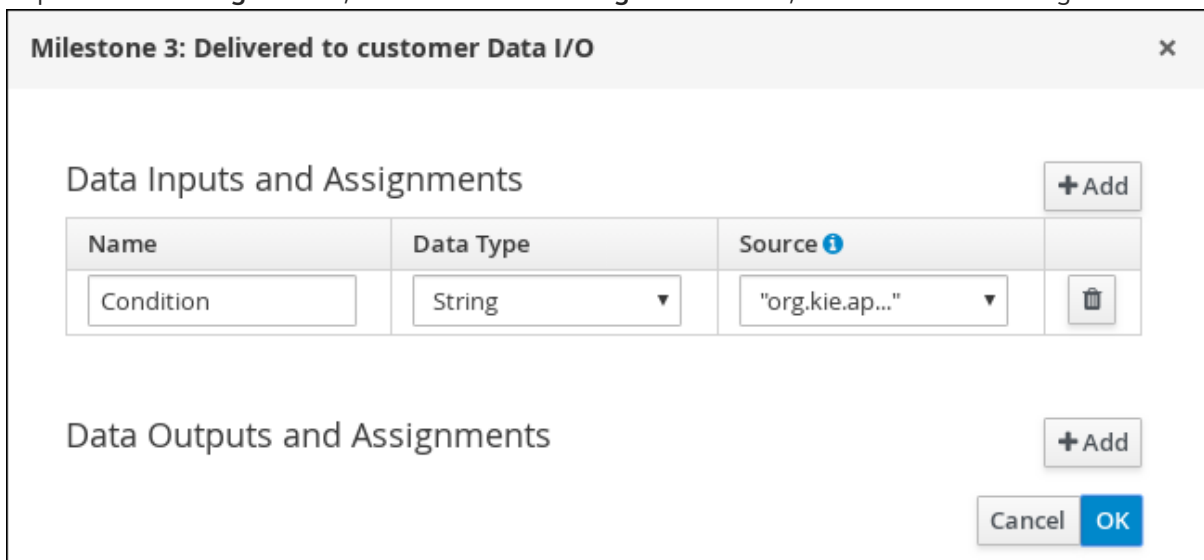

Procedure

1. In the process designer, expand **Milestone** in the **Object Library** and drag a new milestone on the canvas below the **Send to tracking systems** script task.
2. Click the new milestone and in the upper-right corner click the **Properties**  icon.
3. Input **Milestone 3: Delivered to customer** in the **Name** field.
4. Expand **Implementation/Execution** and ensure that **AdHoc Autostart** is not selected.
5. Expand **Data Assignments**, click  in the **Assignments** field, and add the following:



| Name | Data Type | Source  |
|-----------|-----------|--|
| Condition | String | "org.kie.ap..." |

Click the **Source** column drop-down, select **Constant**, and input **org.kie.api.runtime.process.CaseData(data.get("delivered")) == true**. This means that a case variable named **delivered** exists with the value **true**.

6. Click **OK**.
7. Click **Milestone 3: Delivered to customer** and create a new user task.
 - a. Click the new user task and in the upper-right corner click the **Properties**  icon.
 - b. Input **Customer satisfaction survey** in the **Name** field.
 - c. Expand **Implementation/Execution**, click **Add** below the **Actors** menu, click **Select → New**, and input **owner**.
 - d. Input **CustomerSurvey** in the **Task Name** field.
 - e. Select the **Skippable** check box and enter the following text in the in the **Description** field:
Satisfaction survey for order #{Caseld}
 - f. Click  in the **Assignments** field and add the following:

Customer satisfaction survey Data I/O ×

Data Inputs and Assignments + Add

| Name | Data Type | Source i | |
|-------------|-----------|---|--|
| orderNumber | String ▼ | CaseId ▼ | |

Data Outputs and Assignments + Add

| Name | Data Type | Target i | |
|---------|----------------------|---|--|
| survey_ | Survey [org.jbpm.c ▼ | caseFile_survey ▼ | |

Cancel OK

- g. Click **OK**.
8. Click the **Customer satisfaction survey** user task and create an end event.
9. Click **Save** to confirm your changes.

Figure 27.3. Delivered to customer milestone



The IT Orders case can be closed after all milestone sequences are completed. However, due to the ad hoc nature of cases, the case could be reopened if, for example, the order was never received by the customer or the item is faulty. Tasks can be re-triggered or added to the case definition as required, even during run time.

CHAPTER 28. DEPLOYING AND TESTING THE IT ORDER CASE PROJECT

After you create and define all components of the new **IT_Orders_New** case project, deploy and test the new project.

Prerequisites

- You have a running KIE Server instance connected to Business Central. For more information see [Installing and configuring Red Hat Process Automation Manager on Red Hat JBoss EAP 7.3](#).
- You have created a new case in Business Central. For more information, see [Chapter 24, Creating a new IT_Orders case project](#).
- You have created the data objects. For more information, see [Chapter 25, Data objects](#).
- You have created the **Place order** sub-process. For more information, see [Section 26.1, "Creating the Place order sub-process"](#).
- You have designed the **orderhardware** case definition. For more information, see [Chapter 26, Designing the case definition](#).

Procedure

1. In Business Central, go to **Menu** → **Design** → **Projects** and click **IT_Orders_New**.
2. Click **Deploy**.
3. Go to **Menu** → **Manage** → **Process Definitions** → **Manage Process Instances** → **New Process Instance**.
4. Go to **Menu** → **Deploy** and click **Execution Servers** and verify that a new container is deployed and started.

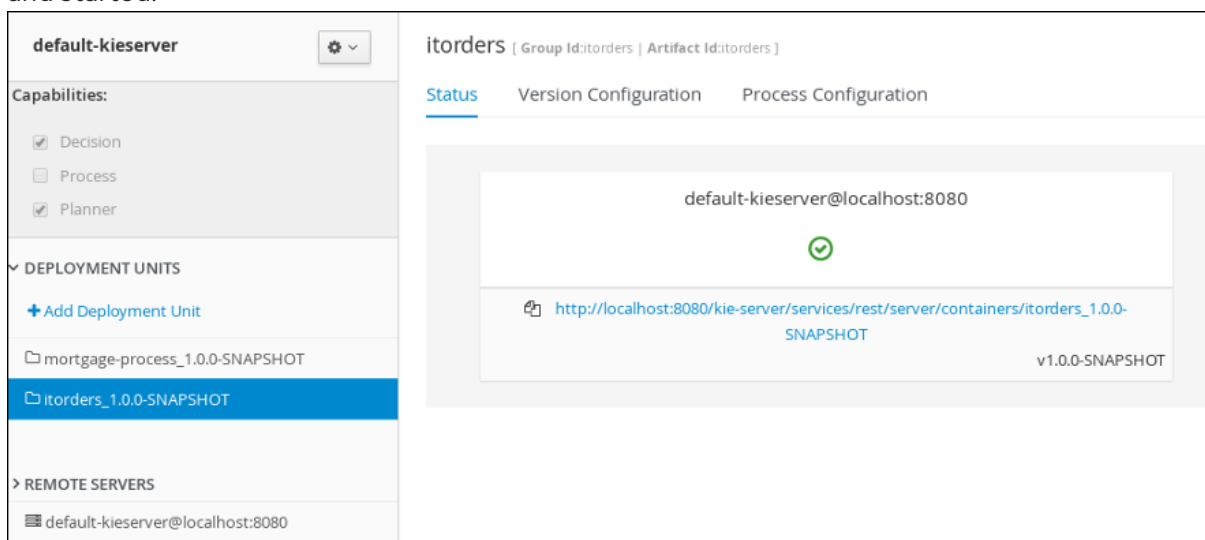

5. Use the Case Management Showcase application to start a new case instance. For instructions about using the Showcase application, see [Using the Showcase application for case management](#).

CHAPTER 29. ADDITIONAL RESOURCES

- *Designing and building cases for case management*
- *Using the Showcase application for case management*
- *Getting started with business processes*

PART IV. GETTING STARTED WITH RED HAT BUILD OF OPTAPLANNER

As a business rules developer, you can use Red Hat build of OptaPlanner to find the optimal solution to planning problems based on a set of limited resources and under specific constraints.

Use this document to start developing solvers with OptaPlanner.

CHAPTER 30. INTRODUCTION TO RED HAT BUILD OF OPTAPLANNER

OptaPlanner is a lightweight, embeddable planning engine that optimizes planning problems. It helps normal Java programmers solve planning problems efficiently, and it combines optimization heuristics and metaheuristics with very efficient score calculations.

For example, OptaPlanner helps solve various use cases:

- *Employee/Patient Rosters*: It helps create time tables for nurses and keeps track of patient bed management.
- *Educational Timetables*: It helps schedule lessons, courses, exams, and conference presentations.
- *Shop Schedules*: It tracks car assembly lines, machine queue planning, and workforce task planning.
- *Cutting Stock*: It minimizes waste by reducing the consumption of resources such as paper and steel.

Every organization faces planning problems; that is, they provide products and services with a limited set of constrained resources (employees, assets, time, and money).

OptaPlanner is open source software under the Apache Software License 2.0. It is 100% pure Java and runs on most Java virtual machines.

30.1. PLANNING PROBLEMS

A *planning problem* has an optimal goal, based on limited resources and under specific constraints. Optimal goals can be any number of things, such as:

- Maximized profits - the optimal goal results in the highest possible profit.
- Minimized ecological footprint - the optimal goal has the least amount of environmental impact.
- Maximized satisfaction for employees or customers - the optimal goal prioritizes the needs of employees or customers.

The ability to achieve these goals relies on the number of resources available. For example, the following resources might be limited:

- The number of people
- Amount of time
- Budget
- Physical assets, for example, machinery, vehicles, computers, buildings, and so on

You must also take into account the specific constraints related to these resources, such as the number of hours a person works, their ability to use certain machines, or compatibility between pieces of equipment.

Red Hat build of OptaPlanner helps Java programmers solve constraint satisfaction problems efficiently. It combines optimization heuristics and metaheuristics with efficient score calculation.

30.2. NP-COMPLETENESS IN PLANNING PROBLEMS

The provided use cases are *probably* [NP-complete](#) or [NP-hard](#), which means the following statements apply:

- It is easy to verify a given solution to a problem in reasonable time.
- There is no simple way to find the optimal solution of a problem in reasonable time.

The implication is that solving your problem is probably harder than you anticipated, because the two common techniques do not suffice:

- A brute force algorithm (even a more advanced variant) takes too long.
- A quick algorithm, for example in the [bin packing problem](#), *putting in the largest items first* returns a solution that is far from optimal.

By using advanced optimization algorithms, OptaPlanner finds a good solution in reasonable time for such planning problems.

30.3. SOLUTIONS TO PLANNING PROBLEMS

A planning problem has a number of solutions.

Several categories of solutions are:

Possible solution

A possible solution is any solution, whether or not it breaks any number of constraints. Planning problems often have an incredibly large number of possible solutions. Many of those solutions are not useful.

Feasible solution

A feasible solution is a solution that does not break any (negative) hard constraints. The number of feasible solutions are relative to the number of possible solutions. Sometimes there are no feasible solutions. Every feasible solution is a possible solution.

Optimal solution

An optimal solution is a solution with the highest score. Planning problems usually have a few optimal solutions. They always have at least one optimal solution, even in the case that there are no feasible solutions and the optimal solution is not feasible.

Best solution found

The best solution is the solution with the highest score found by an implementation in a given amount of time. The best solution found is likely to be feasible and, given enough time, it's an optimal solution.

Counterintuitively, the number of possible solutions is huge (if calculated correctly), even with a small data set.

In the examples provided in the **planner-engine** distribution folder, most instances have a large number of possible solutions. As there is no guaranteed way to find the optimal solution, any implementation is forced to evaluate at least a subset of all those possible solutions.

OptaPlanner supports several optimization algorithms to efficiently wade through that incredibly large number of possible solutions.

Depending on the use case, some optimization algorithms perform better than others, but it is impossible to know in advance. Using OptaPlanner, you can switch the optimization algorithm by changing the solver configuration in a few lines of XML or code.

30.4. CONSTRAINTS ON PLANNING PROBLEMS

Usually, a planning problem has minimum two levels of constraints:

- A *(negative) hard constraint* must not be broken.
For example, one teacher can not teach two different lessons at the same time.
- A *(negative) soft constraint* should not be broken if it can be avoided.
For example, Teacher A does not like to teach on Friday afternoons.

Some problems also have positive constraints:

- A *positive soft constraint (or reward)* should be fulfilled if possible.
For example, Teacher B likes to teach on Monday mornings.

Some basic problems only have hard constraints. Some problems have three or more levels of constraints, for example, hard, medium, and soft constraints.

These constraints define the *score calculation* (otherwise known as the *fitness function*) of a planning problem. Each solution of a planning problem is graded with a score. With OptaPlanner, score constraints are written in an object oriented language such as Java, or in Drools rules.

This type of code is flexible and scalable.

CHAPTER 31. EXAMPLES PROVIDED WITH RED HAT BUILD OF OPTAPLANNER

Several Red Hat build of OptaPlanner examples are shipped with Red Hat Process Automation Manager. You can review the code for examples and modify it as necessary to suit your needs.



NOTE

Red Hat does not provide support for the example code included in the Red Hat Process Automation Manager distribution.

Some of the OptaPlanner examples solve problems that are presented in academic contests. The **Contest** column in the following table lists the contests. It also identifies an example as being either *realistic* or *unrealistic* for the purpose of a contest. A *realistic contest* is an official, independent contest that meets the following standards:

- Clearly defined real-world use cases
- Real-world constraints
- Multiple real-world datasets
- Reproducible results within a specific time limit on specific hardware
- Serious participation from the academic and/or enterprise Operations Research community.

Realistic contests provide an objective comparison of OptaPlanner with competitive software and academic research.

Table 31.1. Examples overview

| Example | Domain | Size | Contest | Directory name |
|------------------------------------|--|---|--|-----------------------|
| N queens | 1 entity class (1 variable) | Entity \leftarrow 256 Value \leftarrow 256 Search space \leftarrow 10^{616} | Pointless (cheatable) | nqueens |
| Cloud balancing | 1 entity class (1 variable) | Entity \leftarrow 2400 Value \leftarrow 800 Search space \leftarrow 10^{6967} | No (Defined by us) | cloudbalancing |
| Traveling salesman | 1 entity class (1 chained variable) | Entity \leftarrow 980 Value \leftarrow 980 Search space \leftarrow 10^{2504} | Unrealistic TSP web | tsp |

| Example | Domain | Size | Contest | Directory name |
|---|--|--|---|-----------------------------|
| Tennis club scheduling | 1 entity class (1 variable) | Entity \Leftarrow 72 Value \Leftarrow 7 Search space \Leftarrow 10^{60} | No (Defined by us) | tennis |
| Meeting scheduling | 1 entity class (2 variables) | Entity \Leftarrow 10 Value \Leftarrow 320 and \Leftarrow 5 Search space \Leftarrow 10^{320} | No (Defined by us) | meetingscheduling |
| Course timetabling | 1 entity class (2 variables) | Entity \Leftarrow 434 Value \Leftarrow 25 and \Leftarrow 20 Search space \Leftarrow 10^{1171} | Realistic ITC 2007 track 3 | curriculumCourse |
| Machine reassignment | 1 entity class (1 variable) | Entity \Leftarrow 50000 Value \Leftarrow 5000 Search space \Leftarrow 10^{184948} | Nearly realistic ROADEF 2012 | machineReassignment |
| Vehicle routing | 1 entity class (1 chained variable) 1 shadow entity class (1 automatic shadow variable) | Entity \Leftarrow 2740 Value \Leftarrow 2795 Search space \Leftarrow 10^{8380} | Unrealistic VRP web | vehiclerouting |
| Vehicle routing with time windows | All of Vehicle routing (1 shadow variable) | Entity \Leftarrow 2740 Value \Leftarrow 2795 Search space \Leftarrow 10^{8380} | Unrealistic VRP web | vehiclerouting |
| Project job scheduling | 1 entity class (2 variables) (1 shadow variable) | Entity \Leftarrow 640 Value \Leftarrow ? and \Leftarrow ? Search space \Leftarrow ? | Nearly realistic MISTA 2013 | projectjobscheduling |

| Example | Domain | Size | Contest | Directory name |
|---------------------------------------|---|---|--|-----------------------------|
| Task assigning | 1 entity class (1 chained variable) (1 shadow variable) 1 shadow entity class (1 automatic shadow variable) | Entity \Leftarrow 500 Value \Leftarrow 520 Search space \Leftarrow 10^{1168} | No Defined by us | taskassigning |
| Exam timetabling | 2 entity classes (same hierarchy) (2 variables) | Entity \Leftarrow 1096 Value \Leftarrow 80 and \Leftarrow 49 Search space \Leftarrow 10^{3374} | Realistic ITC 2007 track 1 | examination |
| Nurse rostering | 1 entity class (1 variable) | Entity \Leftarrow 752 Value \Leftarrow 50 Search space \Leftarrow 10^{1277} | Realistic INRC 2010 | nurserostering |
| Traveling tournament | 1 entity class (1 variable) | Entity \Leftarrow 1560 Value \Leftarrow 78 Search space \Leftarrow 10^{2301} | Unrealistic TTP | travelingtournament |
| Cheap time scheduling | 1 entity class (2 variables) | Entity \Leftarrow 500 Value \Leftarrow 100 and \Leftarrow 288 Search space \Leftarrow 10^{20078} | Nearly realistic ICON Energy | cheaptimescheduling |
| Investment | 1 entity class (1 variable) | Entity \Leftarrow 11 Value = 1000 Search space \Leftarrow 10^4 | No Defined by us | investment |
| Conference scheduling | 1 entity class (2 variables) | Entity \Leftarrow 216 Value \Leftarrow 18 and \Leftarrow 20 Search space \Leftarrow 10^{552} | No Defined by us | conferencescheduling |

| Example | Domain | Size | Contest | Directory name |
|------------------------|--|--|------------------|-----------------------------|
| Rock tour | 1 entity class (1 chained variable) (4 shadow variables) 1 shadow entity class (1 automatic shadow variable) | Entity \leftarrow 47 Value \leftarrow 48 Search space \leftarrow 10^{59} | No Defined by us | rocktour |
| Flight crew scheduling | 1 entity class (1 variable) 1 shadow entity class (1 automatic shadow variable) | Entity \leftarrow 4375 Value \leftarrow 750 Search space \leftarrow 10^{12578} | No Defined by us | flightcrewscheduling |

31.1. N QUEENS

Place n queens on a n sized chessboard so that no two queens can attack each other. The most common n queens puzzle is the eight queens puzzle, with $n = 8$:

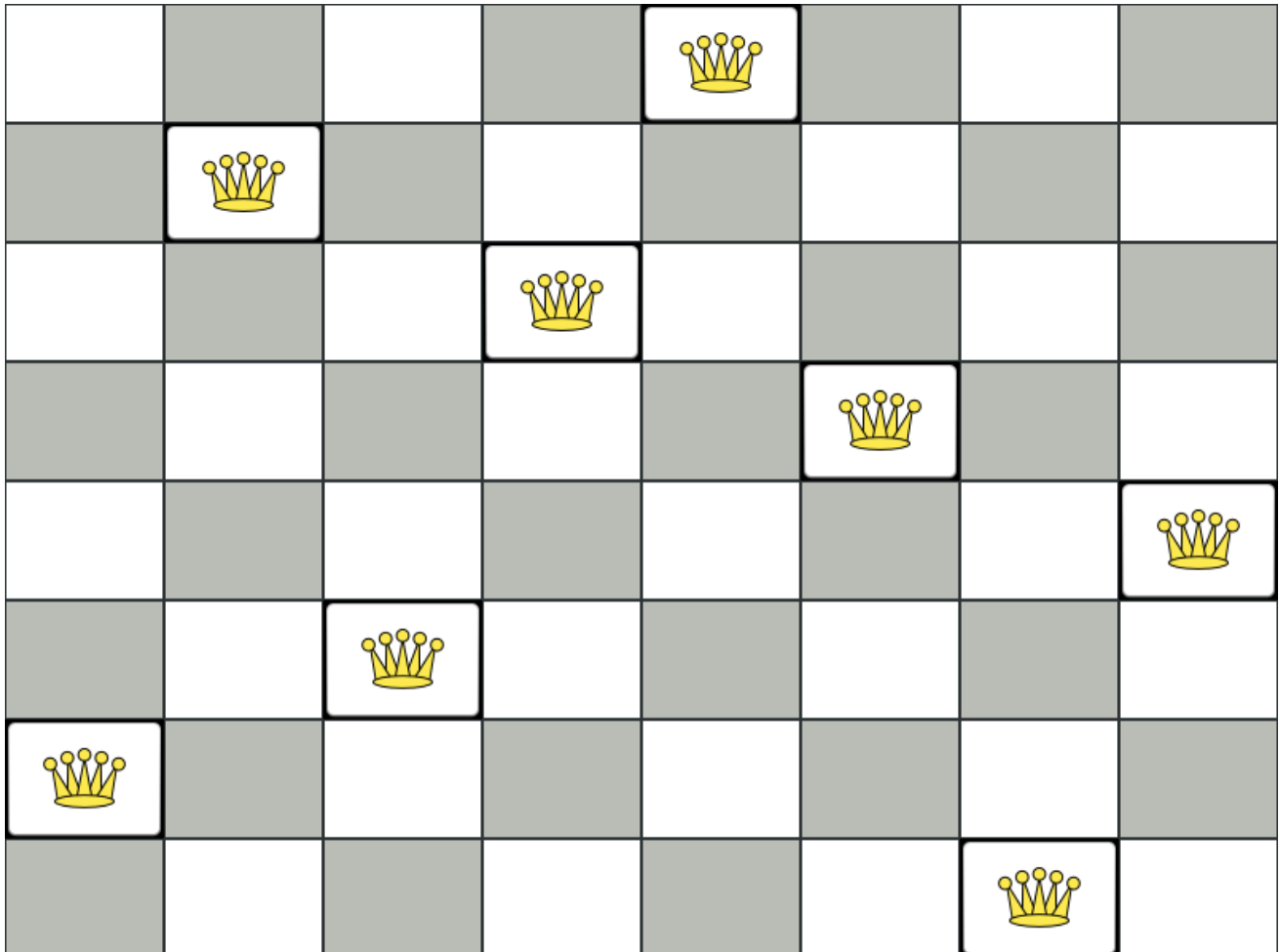

Constraints:

- Use a chessboard of n columns and n rows.
- Place n queens on the chessboard.
- No two queens can attack each other. A queen can attack any other queen on the same horizontal, vertical, or diagonal line.

This documentation heavily uses the four queens puzzle as the primary example.

A proposed solution could be:

Figure 31.1. A wrong solution for the Four queens puzzle

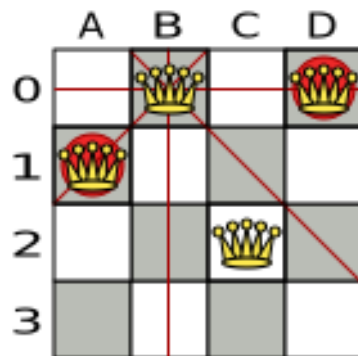

The above solution is wrong because queens **A1** and **B0** can attack each other (so can queens **B0** and **D0**). Removing queen **B0** would respect the "no two queens can attack each other" constraint, but would break the "place n queens" constraint.

Below is a correct solution:

Figure 31.2. A correct solution for the Four queens puzzle

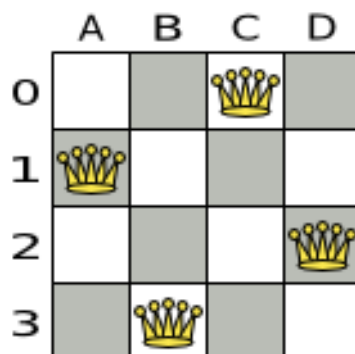

All the constraints have been met, so the solution is correct.

Note that most n queens puzzles have multiple correct solutions. We will focus on finding a single correct solution for a given n , not on finding the number of possible correct solutions for a given n .

Problem size

| | | | |
|----------|-----|----------------------------------|-------------|
| 4queens | has | 4 queens with a search space of | 256. |
| 8queens | has | 8 queens with a search space of | 10^7 . |
| 16queens | has | 16 queens with a search space of | 10^{19} . |

32queens has 32 queens with a search space of 10^{48} .
 64queens has 64 queens with a search space of 10^{115} .
 256queens has 256 queens with a search space of 10^{616} .

The implementation of the n queens example has not been optimized because it functions as a beginner example. Nevertheless, it can easily handle 64 queens. With a few changes it has been shown to easily handle 5000 queens and more.

31.1.1. Domain model for N queens

This example uses the domain model to solve the four queens problem.

- **Creating a Domain Model**

A good domain model will make it easier to understand and solve your planning problem.

This is the domain model for the n queens example:

```
public class Column {
    private int index;

    // ... getters and setters
}

public class Row {
    private int index;

    // ... getters and setters
}

public class Queen {
    private Column column;
    private Row row;

    public int getAscendingDiagonalIndex() {...}
    public int getDescendingDiagonalIndex() {...}

    // ... getters and setters
}
```

- **Calculating the Search Space.**

A **Queen** instance has a **Column** (for example: 0 is column A, 1 is column B, ...) and a **Row** (its row, for example: 0 is row 0, 1 is row 1, ...).

The ascending diagonal line and the descending diagonal line can be calculated based on the column and the row.

The column and row indexes start from the upper left corner of the chessboard.

```
public class NQueens {
    private int n;
```

```
private List<Column> columnList;
private List<Row> rowList;

private List<Queen> queenList;

private SimpleScore score;

// ... getters and setters
}
```

- **Finding the Solution**

A single **NQueens** instance contains a list of all **Queen** instances. It is the **Solution** implementation which will be supplied to, solved by, and retrieved from the Solver.

Notice that in the four queens example, NQueens’s **getN()** method will always return four.

Figure 31.3. A solution for Four Queens

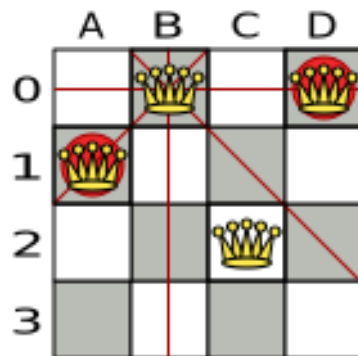

Table 31.2. Details of the solution in the domain model

| | columnIndex | rowIndex | ascendingDiagonalIndex (columnIndex + rowIndex) | descendingDiagonalIndex (columnIndex - rowIndex) |
|----|-------------|----------|--|---|
| A1 | 0 | 1 | 1(**) | -1 |
| B0 | 1 | 0(*) | 1(**) | 1 |
| C2 | 2 | 2 | 4 | 0 |
| D0 | 3 | 0(*) | 3 | 3 |

When two queens share the same column, row or diagonal line, such as (*) and (**), they can attack each other.

31.2. CLOUD BALANCING

For information about this example, see [Red Hat build of OptaPlanner quick start guides](#).

31.3. TRAVELING SALESMAN (TSP - TRAVELING SALESMAN PROBLEM)

Given a list of cities, find the shortest tour for a salesman that visits each city exactly once.

The problem is defined by [Wikipedia](#). It is [one of the most intensively studied problems](#) in computational mathematics. Yet, in the real world, it is often only part of a planning problem, along with other constraints, such as employee shift rostering constraints.

Problem size

dj38 has 38 cities with a search space of 10^{43} .
 europe40 has 40 cities with a search space of 10^{46} .
 st70 has 70 cities with a search space of 10^{98} .
 pcb442 has 442 cities with a search space of 10^{976} .
 lu980 has 980 cities with a search space of 10^{2504} .

Problem difficulty

Despite TSP's simple definition, the problem is surprisingly hard to solve. Because it is an NP-hard problem (like most planning problems), the optimal solution for a specific problem dataset can change a lot when that problem dataset is slightly altered:

TSP optimal solution volatility

How much does the optimal solution change if we add 1 new location?

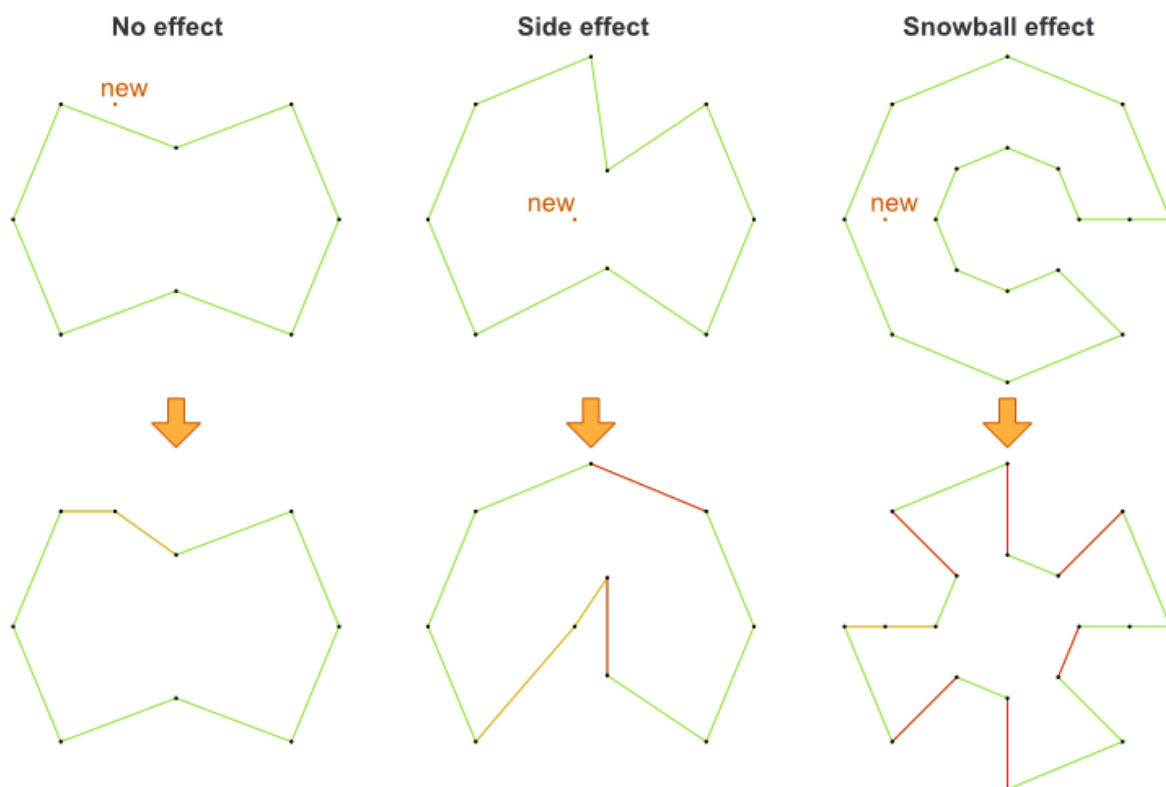

31.4. TENNIS CLUB SCHEDULING

Every week the tennis club has four teams playing round robin against each other. Assign those four spots to the teams fairly.

Hard constraints:

- Conflict: A team can only play once per day.
- Unavailability: Some teams are unavailable on some dates.

Medium constraints:

- Fair assignment: All teams should play an (almost) equal number of times.

Soft constraints:

- Evenly confrontation: Each team should play against every other team an equal number of times.

Problem size

munich-7teams has 7 teams, 18 days, 12 unavailabilityPenalties and 72 teamAssignments with a search space of 10^60.

Figure 31.4. Domain model

Tennis class diagram

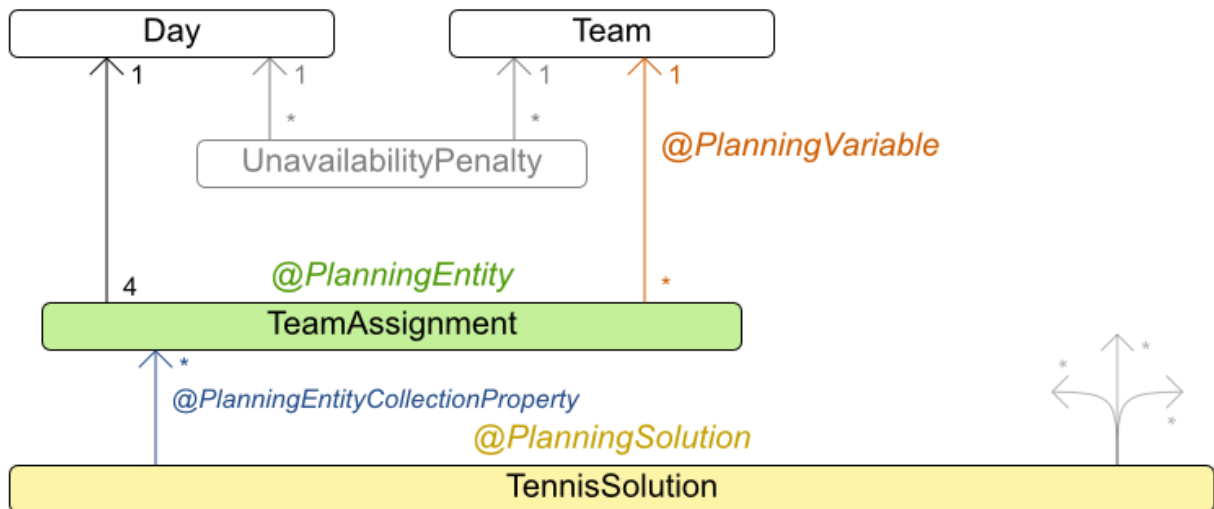

31.5. MEETING SCHEDULING

Assign each meeting to a starting time and a room. Meetings have different durations.

Hard constraints:

- Room conflict: two meetings must not use the same room at the same time.

- Required attendance: A person cannot have two required meetings at the same time.
- Required room capacity: A meeting must not be in a room that doesn't fit all of the meeting's attendees.
- Start and end on same day: A meeting shouldn't be scheduled over multiple days.

Medium constraints:

- Preferred attendance: A person cannot have two preferred meetings at the same time, nor a preferred and a required meeting at the same time.

Soft constraints:

- Sooner rather than later: Schedule all meetings as soon as possible.
- A break between meetings: Any two meetings should have at least one time grain break between them.
- Overlapping meetings: To minimize the number of meetings in parallel so people don't have to choose one meeting over the other.
- Assign larger rooms first: If a larger room is available any meeting should be assigned to that room in order to accommodate as many people as possible even if they haven't signed up to that meeting.
- Room stability: If a person has two consecutive meetings with two or less time grains break between them they better be in the same room.

Problem size

50meetings-160timegrains-5rooms has 50 meetings, 160 timeGrains and 5 rooms with a search space of 10^{145} .

100meetings-320timegrains-5rooms has 100 meetings, 320 timeGrains and 5 rooms with a search space of 10^{320} .

200meetings-640timegrains-5rooms has 200 meetings, 640 timeGrains and 5 rooms with a search space of 10^{701} .

400meetings-1280timegrains-5rooms has 400 meetings, 1280 timeGrains and 5 rooms with a search space of 10^{1522} .

800meetings-2560timegrains-5rooms has 800 meetings, 2560 timeGrains and 5 rooms with a search space of 10^{3285} .

31.6. COURSE TIMETABLING (ITC 2007 TRACK 3 - CURRICULUM COURSE SCHEDULING)

Schedule each lecture into a timeslot and into a room.

Hard constraints:

- Teacher conflict: A teacher must not have two lectures in the same period.
- Curriculum conflict: A curriculum must not have two lectures in the same period.
- Room occupancy: Two lectures must not be in the same room in the same period.

- Unavailable period (specified per dataset): A specific lecture must not be assigned to a specific period.

Soft constraints:

- Room capacity: A room's capacity should not be less than the number of students in its lecture.
- Minimum working days: Lectures of the same course should be spread out into a minimum number of days.
- Curriculum compactness: Lectures belonging to the same curriculum should be adjacent to each other (so in consecutive periods).
- Room stability: Lectures of the same course should be assigned to the same room.

The problem is defined by [the International Timetabling Competition 2007 track 3](#).

Problem size

comp01 has 24 teachers, 14 curricula, 30 courses, 160 lectures, 30 periods, 6 rooms and 53 unavailable period constraints with a search space of 10^{360} .

comp02 has 71 teachers, 70 curricula, 82 courses, 283 lectures, 25 periods, 16 rooms and 513 unavailable period constraints with a search space of 10^{736} .

comp03 has 61 teachers, 68 curricula, 72 courses, 251 lectures, 25 periods, 16 rooms and 382 unavailable period constraints with a search space of 10^{653} .

comp04 has 70 teachers, 57 curricula, 79 courses, 286 lectures, 25 periods, 18 rooms and 396 unavailable period constraints with a search space of 10^{758} .

comp05 has 47 teachers, 139 curricula, 54 courses, 152 lectures, 36 periods, 9 rooms and 771 unavailable period constraints with a search space of 10^{381} .

comp06 has 87 teachers, 70 curricula, 108 courses, 361 lectures, 25 periods, 18 rooms and 632 unavailable period constraints with a search space of 10^{957} .

comp07 has 99 teachers, 77 curricula, 131 courses, 434 lectures, 25 periods, 20 rooms and 667 unavailable period constraints with a search space of 10^{1171} .

comp08 has 76 teachers, 61 curricula, 86 courses, 324 lectures, 25 periods, 18 rooms and 478 unavailable period constraints with a search space of 10^{859} .

comp09 has 68 teachers, 75 curricula, 76 courses, 279 lectures, 25 periods, 18 rooms and 405 unavailable period constraints with a search space of 10^{740} .

comp10 has 88 teachers, 67 curricula, 115 courses, 370 lectures, 25 periods, 18 rooms and 694 unavailable period constraints with a search space of 10^{981} .

comp11 has 24 teachers, 13 curricula, 30 courses, 162 lectures, 45 periods, 5 rooms and 94 unavailable period constraints with a search space of 10^{381} .

comp12 has 74 teachers, 150 curricula, 88 courses, 218 lectures, 36 periods, 11 rooms and 1368 unavailable period constraints with a search space of 10^{566} .

comp13 has 77 teachers, 66 curricula, 82 courses, 308 lectures, 25 periods, 19 rooms and 468 unavailable period constraints with a search space of 10^{824} .

comp14 has 68 teachers, 60 curricula, 85 courses, 275 lectures, 25 periods, 17 rooms and 486 unavailable period constraints with a search space of 10^{722} .

Figure 31.5. Domain model

Curriculum course class diagram

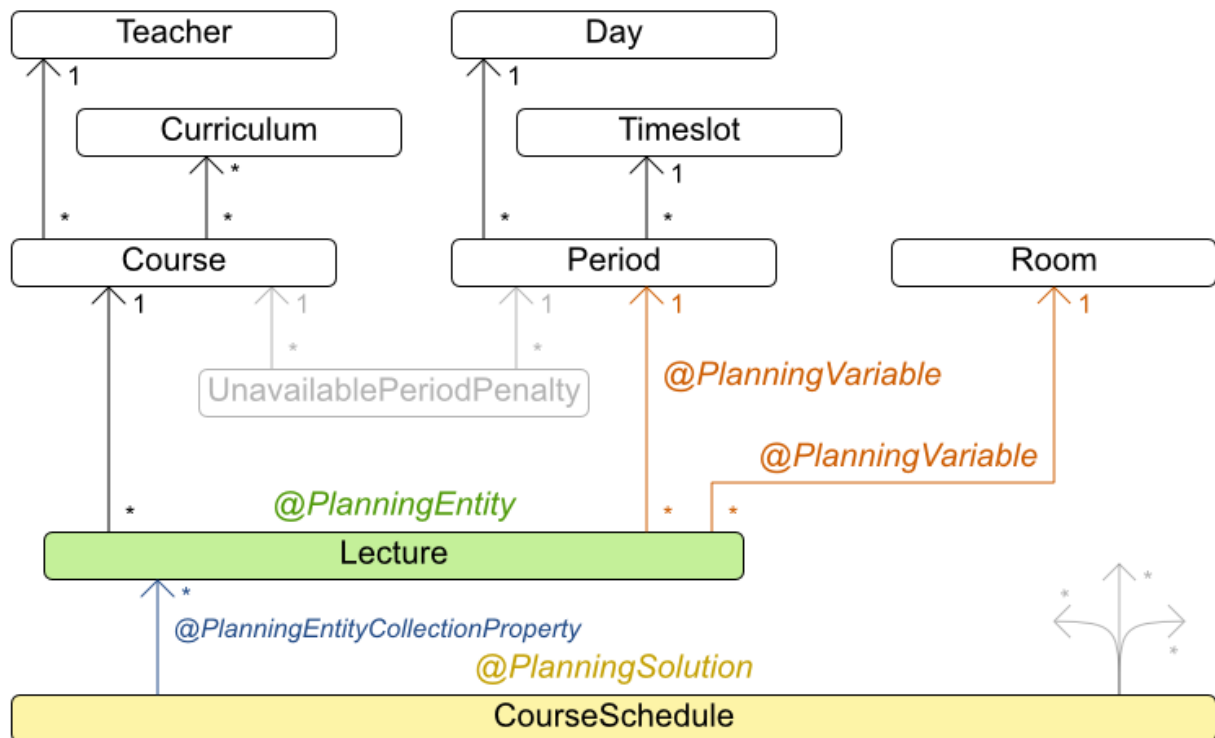

31.7. MACHINE REASSIGNMENT (GOOGLE ROADEF 2012)

Assign each process to a machine. All processes already have an original (unoptimized) assignment. Each process requires an amount of each resource (such as CPU or RAM). This is a more complex version of the Cloud Balancing example.

Hard constraints:

- Maximum capacity: The maximum capacity for each resource for each machine must not be exceeded.
- Conflict: Processes of the same service must run on distinct machines.
- Spread: Processes of the same service must be spread out across locations.
- Dependency: The processes of a service depending on another service must run in the neighborhood of a process of the other service.
- Transient usage: Some resources are transient and count towards the maximum capacity of both the original machine as the newly assigned machine.

Soft constraints:

- Load: The safety capacity for each resource for each machine should not be exceeded.

- Balance: Leave room for future assignments by balancing the available resources on each machine.
- Process move cost: A process has a move cost.
- Service move cost: A service has a move cost.
- Machine move cost: Moving a process from machine A to machine B has another A-B specific move cost.

The problem is defined by [the Google ROADEF/EURO Challenge 2012](#).

Cloud optimization is like Tetris

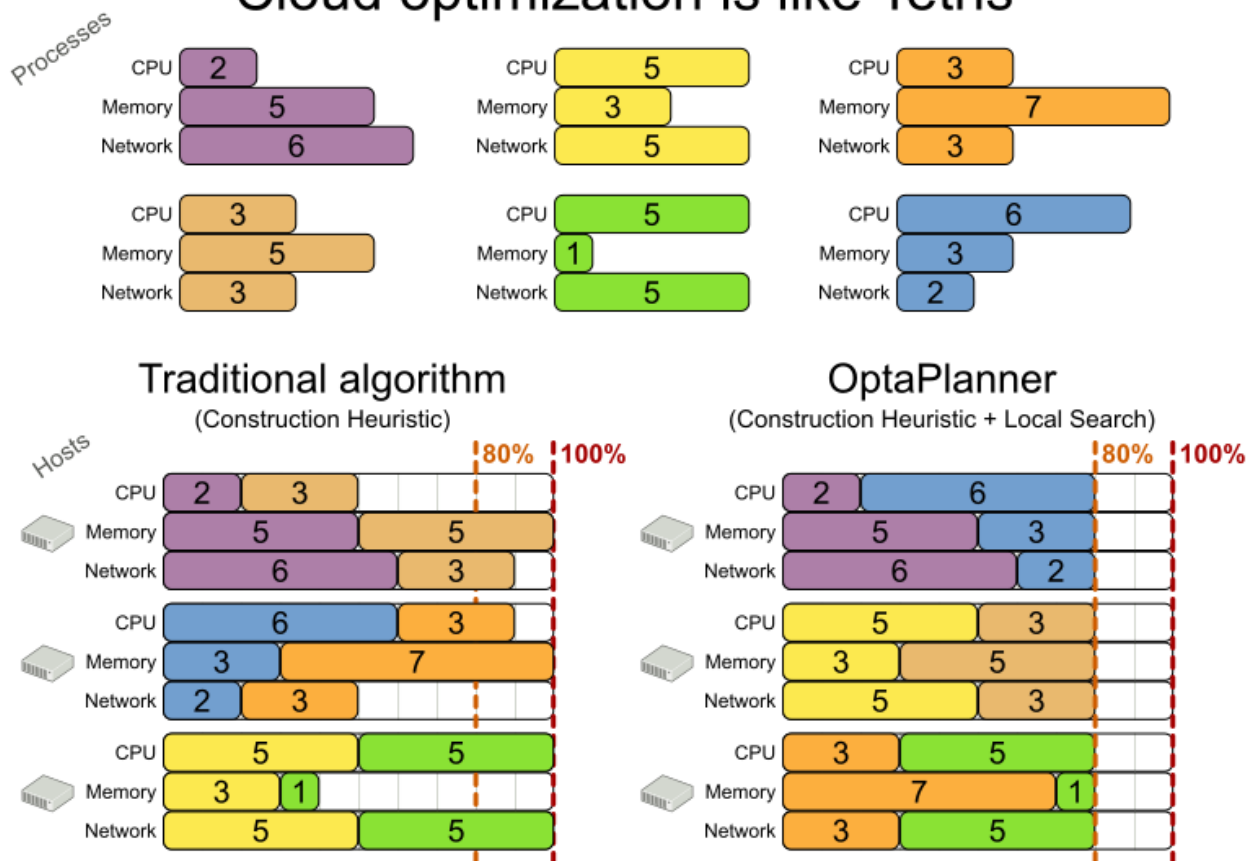
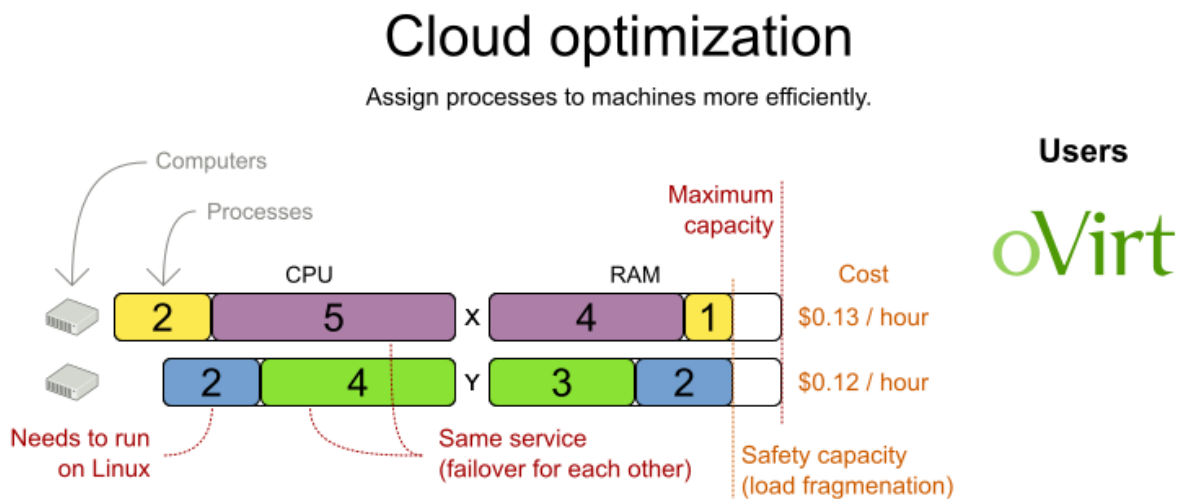

Figure 31.6. Value proposition



CloudBalancing benchmark

Cloud hosting cost

Average

-18%

Min/Max

-16%
-21%

datasets

5

Biggest dataset

1600 computers
4800 processes

OptaPlanner versus traditional algorithm with domain knowledge

5 mins Simulated Annealing vs First Fit Decreasing

MachineReassignment benchmark

Hardware congestion

Average

-63%

Min/Max

-25%
-97%

datasets

20

Biggest dataset

50k machines
5k processes

OptaPlanner versus arbitrary feasible assignments

5 mins Tabu Search vs First Feasible Fit

Don't believe us? Run our open benchmarks yourself: <http://www.optaplanner.org/code/benchmarks.html>

Problem size

model_a1_1 has 2 resources, 1 neighborhoods, 4 locations, 4 machines, 79 services, 100 processes and 1 balancePenalties with a search space of 10^{60} .

model_a1_2 has 4 resources, 2 neighborhoods, 4 locations, 100 machines, 980 services, 1000 processes and 0 balancePenalties with a search space of 10^{2000} .

model_a1_3 has 3 resources, 5 neighborhoods, 25 locations, 100 machines, 216 services, 1000 processes and 0 balancePenalties with a search space of 10^{2000} .

model_a1_4 has 3 resources, 50 neighborhoods, 50 locations, 50 machines, 142 services, 1000 processes and 1 balancePenalties with a search space of 10^{1698} .

model_a1_5 has 4 resources, 2 neighborhoods, 4 locations, 12 machines, 981 services, 1000 processes and 1 balancePenalties with a search space of 10^{1079} .

model_a2_1 has 3 resources, 1 neighborhoods, 1 locations, 100 machines, 1000 services, 1000 processes and 0 balancePenalties with a search space of 10^{2000} .

model_a2_2 has 12 resources, 5 neighborhoods, 25 locations, 100 machines, 170 services, 1000 processes and 0 balancePenalties with a search space of 10^{2000} .

model_a2_3 has 12 resources, 5 neighborhoods, 25 locations, 100 machines, 129 services, 1000 processes and 0 balancePenalties with a search space of 10^{2000} .

model_a2_4 has 12 resources, 5 neighborhoods, 25 locations, 50 machines, 180 services, 1000 processes and 1 balancePenalties with a search space of 10^{1698} .

model_a2_5 has 12 resources, 5 neighborhoods, 25 locations, 50 machines, 153 services, 1000 processes and 0 balancePenalties with a search space of 10^{1698} .

model_b_1 has 12 resources, 5 neighborhoods, 10 locations, 100 machines, 2512 services, 5000 processes and 0 balancePenalties with a search space of 10^{10000} .

model_b_2 has 12 resources, 5 neighborhoods, 10 locations, 100 machines, 2462 services, 5000 processes and 1 balancePenalties with a search space of 10^{10000} .

model_b_3 has 6 resources, 5 neighborhoods, 10 locations, 100 machines, 15025 services, 20000 processes and 0 balancePenalties with a search space of 10^4 0000.
 model_b_4 has 6 resources, 5 neighborhoods, 50 locations, 500 machines, 1732 services, 20000 processes and 1 balancePenalties with a search space of 10^5 3979.
 model_b_5 has 6 resources, 5 neighborhoods, 10 locations, 100 machines, 35082 services, 40000 processes and 0 balancePenalties with a search space of 10^8 0000.
 model_b_6 has 6 resources, 5 neighborhoods, 50 locations, 200 machines, 14680 services, 40000 processes and 1 balancePenalties with a search space of 10^9 2041.
 model_b_7 has 6 resources, 5 neighborhoods, 50 locations, 4000 machines, 15050 services, 40000 processes and 1 balancePenalties with a search space of 10^{14} 4082.
 model_b_8 has 3 resources, 5 neighborhoods, 10 locations, 100 machines, 45030 services, 50000 processes and 0 balancePenalties with a search space of 10^{10} 0000.
 model_b_9 has 3 resources, 5 neighborhoods, 100 locations, 1000 machines, 4609 services, 50000 processes and 1 balancePenalties with a search space of 10^{15} 0000.
 model_b_10 has 3 resources, 5 neighborhoods, 100 locations, 5000 machines, 4896 services, 50000 processes and 1 balancePenalties with a search space of 10^{18} 4948.

Figure 31.7. Domain model

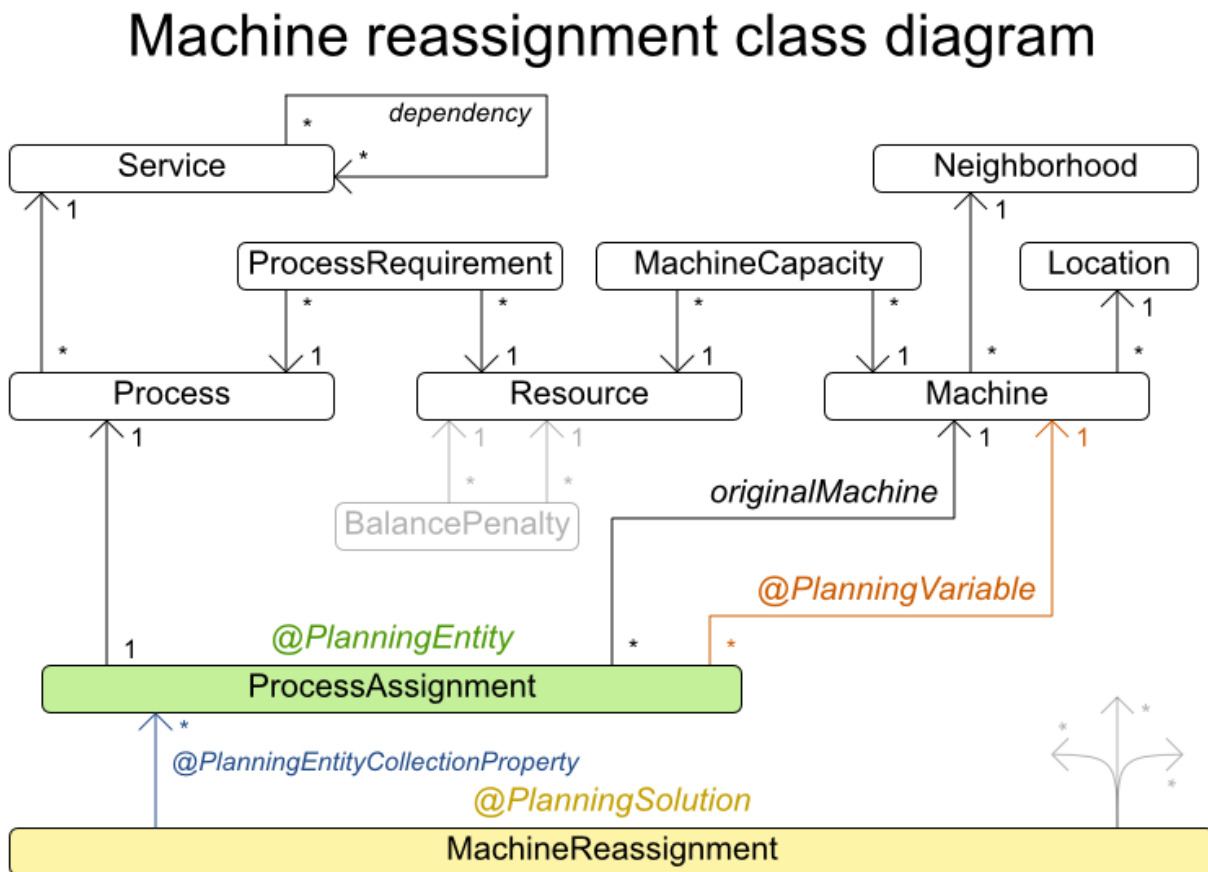

31.8. VEHICLE ROUTING

Using a fleet of vehicles, pick up the objects of each customer and bring them to the depot. Each vehicle can service multiple customers, but it has a limited capacity.

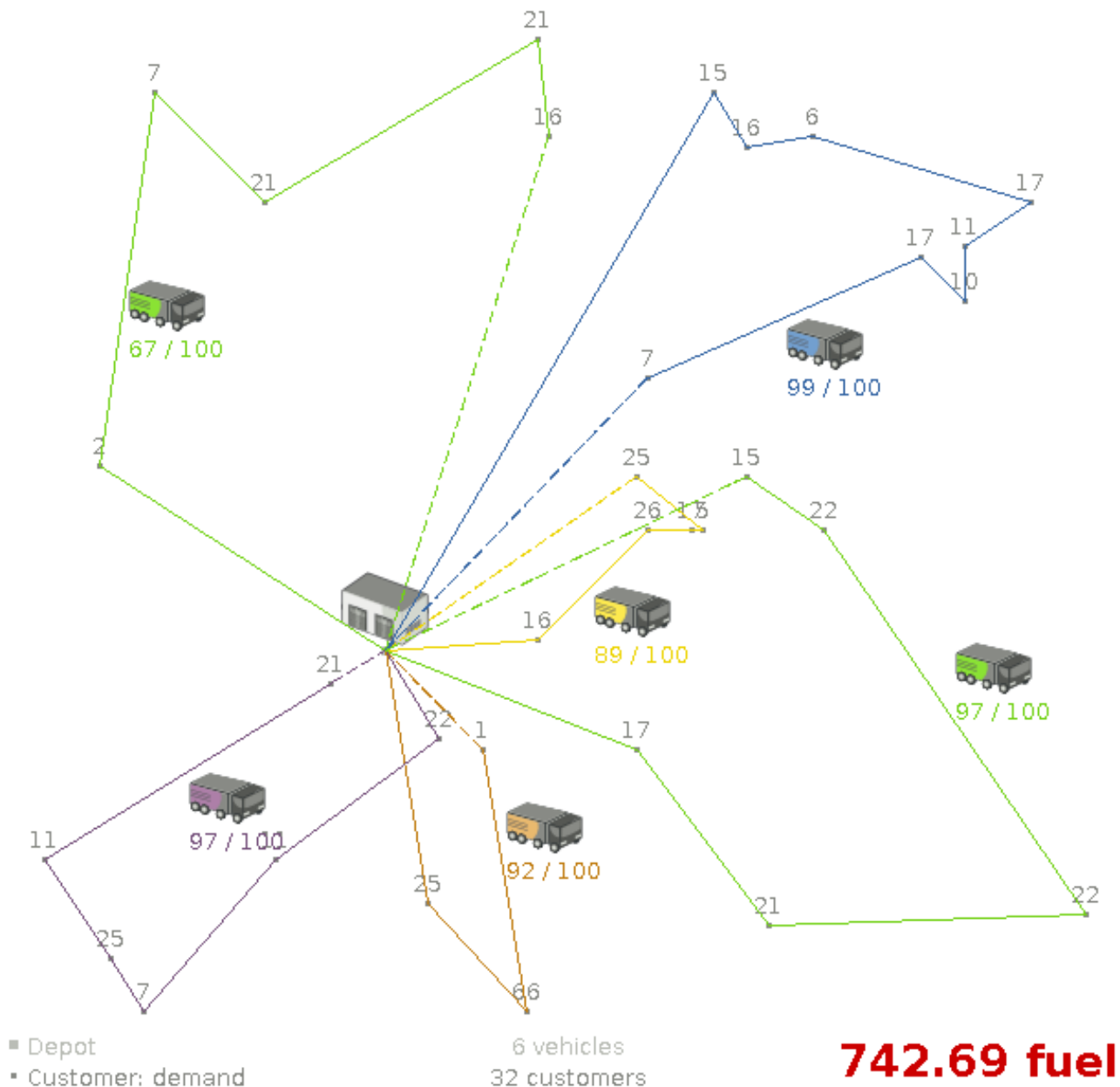

Besides the basic case (CVRP), there is also a variant with time windows (CVRPTW).

Hard constraints:

- Vehicle capacity: a vehicle cannot carry more items than its capacity.
- Time windows (only in CVRPTW):
 - Travel time: Traveling from one location to another takes time.
 - Customer service duration: a vehicle must stay at the customer for the length of the service duration.
 - Customer ready time: a vehicle may arrive before the customer's ready time, but it must wait until the ready time before servicing.
 - Customer due time: a vehicle must arrive on time, before the customer's due time.

Soft constraints:

- Total distance: minimize the total distance driven (fuel consumption) of all vehicles.

The capacitated vehicle routing problem (CVRP) and its time-windowed variant (CVRPTW) are defined by the VRP web.

Figure 31.8. Value proposition

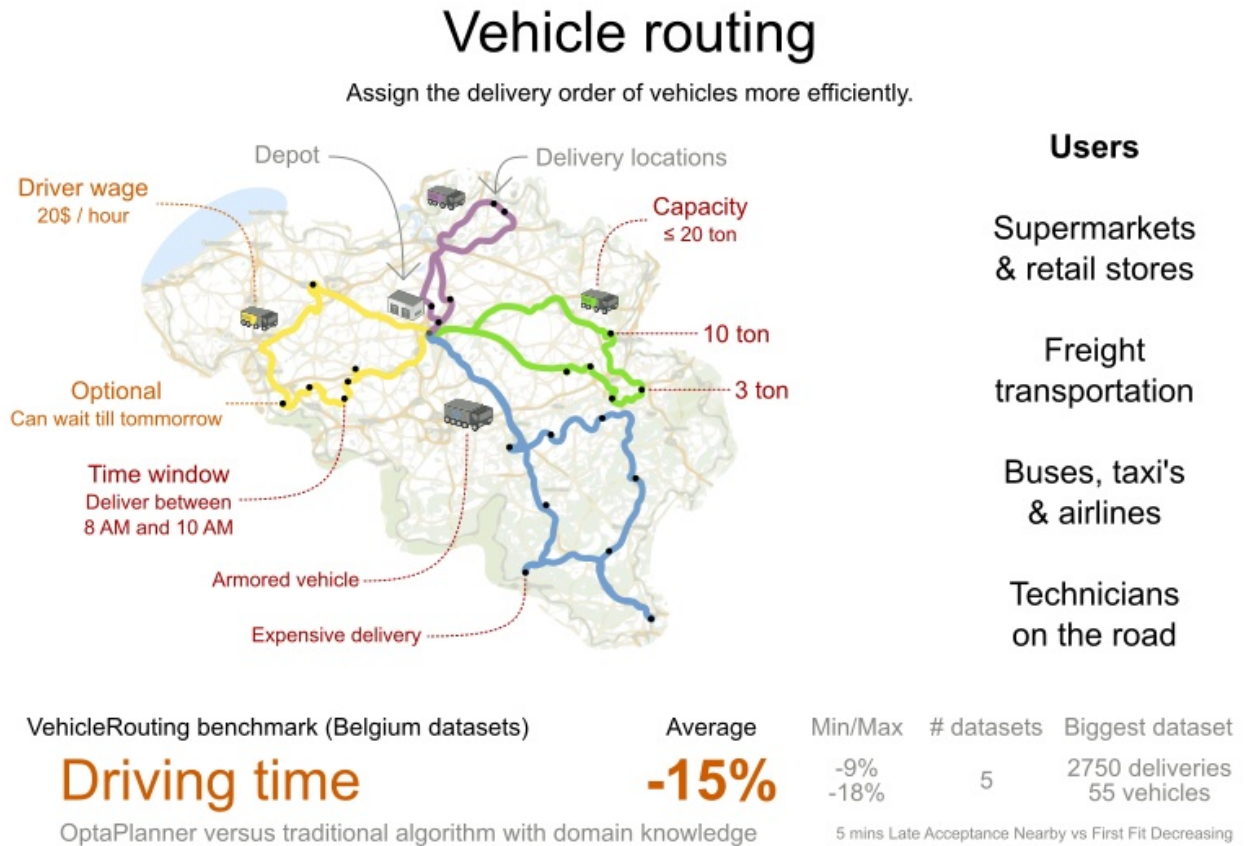

Don't believe us? Run our open benchmarks yourself: <http://www.optaplanner.org/code/benchmarks.html>

Problem size

CVRP instances (without time windows):

| | |
|---------------------------|---|
| belgium-n50-k10 | has 1 depots, 10 vehicles and 49 customers with a search space of 10^{74} . |
| belgium-n100-k10 | has 1 depots, 10 vehicles and 99 customers with a search space of 10^{170} . |
| belgium-n500-k20 | has 1 depots, 20 vehicles and 499 customers with a search space of 10^{1168} . |
| belgium-n1000-k20 | has 1 depots, 20 vehicles and 999 customers with a search space of 10^{2607} . |
| belgium-n2750-k55 | has 1 depots, 55 vehicles and 2749 customers with a search space of 10^{8380} . |
| belgium-road-km-n50-k10 | has 1 depots, 10 vehicles and 49 customers with a search space of 10^{74} . |
| belgium-road-km-n100-k10 | has 1 depots, 10 vehicles and 99 customers with a search space of 10^{170} . |
| belgium-road-km-n500-k20 | has 1 depots, 20 vehicles and 499 customers with a search space of 10^{1168} . |
| belgium-road-km-n1000-k20 | has 1 depots, 20 vehicles and 999 customers with a search space of 10^{2607} . |
| belgium-road-km-n2750-k55 | has 1 depots, 55 vehicles and 2749 customers with a search space of 10^{8380} . |

10⁸³⁸⁰.

belgium-road-time-n50-k10 has 1 depots, 10 vehicles and 49 customers with a search space of 10⁷⁴.

belgium-road-time-n100-k10 has 1 depots, 10 vehicles and 99 customers with a search space of 10¹⁷⁰.

belgium-road-time-n500-k20 has 1 depots, 20 vehicles and 499 customers with a search space of 10¹¹⁶⁸.

belgium-road-time-n1000-k20 has 1 depots, 20 vehicles and 999 customers with a search space of 10²⁶⁰⁷.

belgium-road-time-n2750-k55 has 1 depots, 55 vehicles and 2749 customers with a search space of 10⁸³⁸⁰.

belgium-d2-n50-k10 has 2 depots, 10 vehicles and 48 customers with a search space of 10⁷⁴.

belgium-d3-n100-k10 has 3 depots, 10 vehicles and 97 customers with a search space of 10¹⁷⁰.

belgium-d5-n500-k20 has 5 depots, 20 vehicles and 495 customers with a search space of 10¹¹⁶⁸.

belgium-d8-n1000-k20 has 8 depots, 20 vehicles and 992 customers with a search space of 10²⁶⁰⁷.

belgium-d10-n2750-k55 has 10 depots, 55 vehicles and 2740 customers with a search space of 10⁸³⁸⁰.

A-n32-k5 has 1 depots, 5 vehicles and 31 customers with a search space of 10⁴⁰.

A-n33-k5 has 1 depots, 5 vehicles and 32 customers with a search space of 10⁴¹.

A-n33-k6 has 1 depots, 6 vehicles and 32 customers with a search space of 10⁴².

A-n34-k5 has 1 depots, 5 vehicles and 33 customers with a search space of 10⁴³.

A-n36-k5 has 1 depots, 5 vehicles and 35 customers with a search space of 10⁴⁶.

A-n37-k5 has 1 depots, 5 vehicles and 36 customers with a search space of 10⁴⁸.

A-n37-k6 has 1 depots, 6 vehicles and 36 customers with a search space of 10⁴⁹.

A-n38-k5 has 1 depots, 5 vehicles and 37 customers with a search space of 10⁴⁹.

A-n39-k5 has 1 depots, 5 vehicles and 38 customers with a search space of 10⁵¹.

A-n39-k6 has 1 depots, 6 vehicles and 38 customers with a search space of 10⁵².

A-n44-k7 has 1 depots, 7 vehicles and 43 customers with a search space of 10⁶¹.

A-n45-k6 has 1 depots, 6 vehicles and 44 customers with a search space of 10⁶².

A-n45-k7 has 1 depots, 7 vehicles and 44 customers with a search space of 10⁶³.

A-n46-k7 has 1 depots, 7 vehicles and 45 customers with a search space of 10⁶⁵.

A-n48-k7 has 1 depots, 7 vehicles and 47 customers with a search space of 10⁶⁸.

A-n53-k7 has 1 depots, 7 vehicles and 52 customers with a search space of 10⁷⁷.

A-n54-k7 has 1 depots, 7 vehicles and 53 customers with a search space of 10⁷⁹.

A-n55-k9 has 1 depots, 9 vehicles and 54 customers with a search space of 10⁸².

A-n60-k9 has 1 depots, 9 vehicles and 59 customers with a search space of 10⁹¹.

A-n61-k9 has 1 depots, 9 vehicles and 60 customers with a search space of 10⁹³.

A-n62-k8 has 1 depots, 8 vehicles and 61 customers with a search space of 10⁹⁴.

A-n63-k9 has 1 depots, 9 vehicles and 62 customers with a search space of 10⁹⁷.

A-n63-k10 has 1 depots, 10 vehicles and 62 customers with a search space of 10⁹⁸.

A-n64-k9 has 1 depots, 9 vehicles and 63 customers with a search space of 10⁹⁹.

A-n65-k9 has 1 depots, 9 vehicles and 64 customers with a search space of 10¹⁰¹.

A-n69-k9 has 1 depots, 9 vehicles and 68 customers with a search space of 10¹⁰⁸.

A-n80-k10 has 1 depots, 10 vehicles and 79 customers with a search space of 10¹³⁰.

F-n45-k4 has 1 depots, 4 vehicles and 44 customers with a search space of 10⁶⁰.

F-n72-k4 has 1 depots, 4 vehicles and 71 customers with a search space of 10¹⁰⁸.

F-n135-k7 has 1 depots, 7 vehicles and 134 customers with a search space of 10²⁴⁰.

CVRPTW instances (with time windows):

belgium-tw-d2-n50-k10 has 2 depots, 10 vehicles and 48 customers with a search space of

10⁷⁴.
belgium-tw-d3-n100-k10 has 3 depots, 10 vehicles and 97 customers with a search space of 10¹⁷⁰.
belgium-tw-d5-n500-k20 has 5 depots, 20 vehicles and 495 customers with a search space of 10¹¹⁶⁸.
belgium-tw-d8-n1000-k20 has 8 depots, 20 vehicles and 992 customers with a search space of 10²⁶⁰⁷.
belgium-tw-d10-n2750-k55 has 10 depots, 55 vehicles and 2740 customers with a search space of 10⁸³⁸⁰.
belgium-tw-n50-k10 has 1 depots, 10 vehicles and 49 customers with a search space of 10⁷⁴.
belgium-tw-n100-k10 has 1 depots, 10 vehicles and 99 customers with a search space of 10¹⁷⁰.
belgium-tw-n500-k20 has 1 depots, 20 vehicles and 499 customers with a search space of 10¹¹⁶⁸.
belgium-tw-n1000-k20 has 1 depots, 20 vehicles and 999 customers with a search space of 10²⁶⁰⁷.
belgium-tw-n2750-k55 has 1 depots, 55 vehicles and 2749 customers with a search space of 10⁸³⁸⁰.

Solomon_025_C101 has 1 depots, 25 vehicles and 25 customers with a search space of 10⁴⁰.
Solomon_025_C201 has 1 depots, 25 vehicles and 25 customers with a search space of 10⁴⁰.
Solomon_025_R101 has 1 depots, 25 vehicles and 25 customers with a search space of 10⁴⁰.
Solomon_025_R201 has 1 depots, 25 vehicles and 25 customers with a search space of 10⁴⁰.
Solomon_025_RC101 has 1 depots, 25 vehicles and 25 customers with a search space of 10⁴⁰.
Solomon_025_RC201 has 1 depots, 25 vehicles and 25 customers with a search space of 10⁴⁰.
Solomon_100_C101 has 1 depots, 25 vehicles and 100 customers with a search space of 10¹⁸⁵.
Solomon_100_C201 has 1 depots, 25 vehicles and 100 customers with a search space of 10¹⁸⁵.
Solomon_100_R101 has 1 depots, 25 vehicles and 100 customers with a search space of 10¹⁸⁵.
Solomon_100_R201 has 1 depots, 25 vehicles and 100 customers with a search space of 10¹⁸⁵.
Solomon_100_RC101 has 1 depots, 25 vehicles and 100 customers with a search space of 10¹⁸⁵.
Solomon_100_RC201 has 1 depots, 25 vehicles and 100 customers with a search space of 10¹⁸⁵.
Homberger_0200_C1_2_1 has 1 depots, 50 vehicles and 200 customers with a search space of 10⁴²⁹.
Homberger_0200_C2_2_1 has 1 depots, 50 vehicles and 200 customers with a search space of 10⁴²⁹.
Homberger_0200_R1_2_1 has 1 depots, 50 vehicles and 200 customers with a search space of 10⁴²⁹.
Homberger_0200_R2_2_1 has 1 depots, 50 vehicles and 200 customers with a search space of 10⁴²⁹.
Homberger_0200_RC1_2_1 has 1 depots, 50 vehicles and 200 customers with a search space of 10⁴²⁹.
Homberger_0200_RC2_2_1 has 1 depots, 50 vehicles and 200 customers with a search space of 10⁴²⁹.

Homberger_0400_C1_4_1 has 1 depots, 100 vehicles and 400 customers with a search space of 10^{978} .

Homberger_0400_C2_4_1 has 1 depots, 100 vehicles and 400 customers with a search space of 10^{978} .

Homberger_0400_R1_4_1 has 1 depots, 100 vehicles and 400 customers with a search space of 10^{978} .

Homberger_0400_R2_4_1 has 1 depots, 100 vehicles and 400 customers with a search space of 10^{978} .

Homberger_0400_RC1_4_1 has 1 depots, 100 vehicles and 400 customers with a search space of 10^{978} .

Homberger_0400_RC2_4_1 has 1 depots, 100 vehicles and 400 customers with a search space of 10^{978} .

Homberger_0600_C1_6_1 has 1 depots, 150 vehicles and 600 customers with a search space of 10^{1571} .

Homberger_0600_C2_6_1 has 1 depots, 150 vehicles and 600 customers with a search space of 10^{1571} .

Homberger_0600_R1_6_1 has 1 depots, 150 vehicles and 600 customers with a search space of 10^{1571} .

Homberger_0600_R2_6_1 has 1 depots, 150 vehicles and 600 customers with a search space of 10^{1571} .

Homberger_0600_RC1_6_1 has 1 depots, 150 vehicles and 600 customers with a search space of 10^{1571} .

Homberger_0600_RC2_6_1 has 1 depots, 150 vehicles and 600 customers with a search space of 10^{1571} .

Homberger_0800_C1_8_1 has 1 depots, 200 vehicles and 800 customers with a search space of 10^{2195} .

Homberger_0800_C2_8_1 has 1 depots, 200 vehicles and 800 customers with a search space of 10^{2195} .

Homberger_0800_R1_8_1 has 1 depots, 200 vehicles and 800 customers with a search space of 10^{2195} .

Homberger_0800_R2_8_1 has 1 depots, 200 vehicles and 800 customers with a search space of 10^{2195} .

Homberger_0800_RC1_8_1 has 1 depots, 200 vehicles and 800 customers with a search space of 10^{2195} .

Homberger_0800_RC2_8_1 has 1 depots, 200 vehicles and 800 customers with a search space of 10^{2195} .

Homberger_1000_C110_1 has 1 depots, 250 vehicles and 1000 customers with a search space of 10^{2840} .

Homberger_1000_C210_1 has 1 depots, 250 vehicles and 1000 customers with a search space of 10^{2840} .

Homberger_1000_R110_1 has 1 depots, 250 vehicles and 1000 customers with a search space of 10^{2840} .

Homberger_1000_R210_1 has 1 depots, 250 vehicles and 1000 customers with a search space of 10^{2840} .

Homberger_1000_RC110_1 has 1 depots, 250 vehicles and 1000 customers with a search space of 10^{2840} .

Homberger_1000_RC210_1 has 1 depots, 250 vehicles and 1000 customers with a search space of 10^{2840} .

31.8.1. Domain model for Vehicle routing

Vehicle routing class diagram

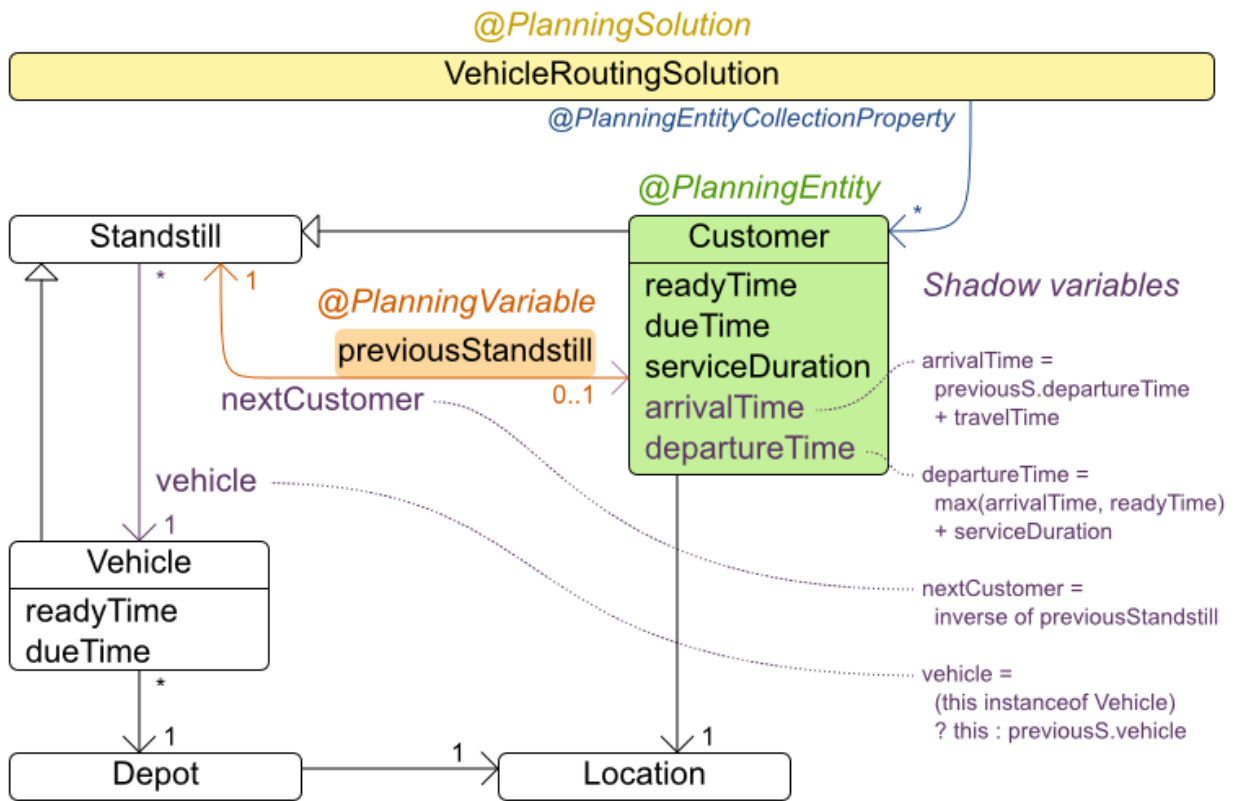

The vehicle routing with timewindows domain model makes heavily use of the shadow variable feature. This allows it to express its constraints more naturally, because properties such as **arrivalTime** and **departureTime**, are directly available on the domain model.

Road Distances Instead of Air Distances

In the real world, vehicles cannot follow a straight line from location to location: they have to use roads and highways. From a business point of view, this matters a lot:

Vehicle routing distance type

Can we optimize for air distances, when we need road distances or driving times?

Optimized for ...

... air distance

... road distance

... driving time

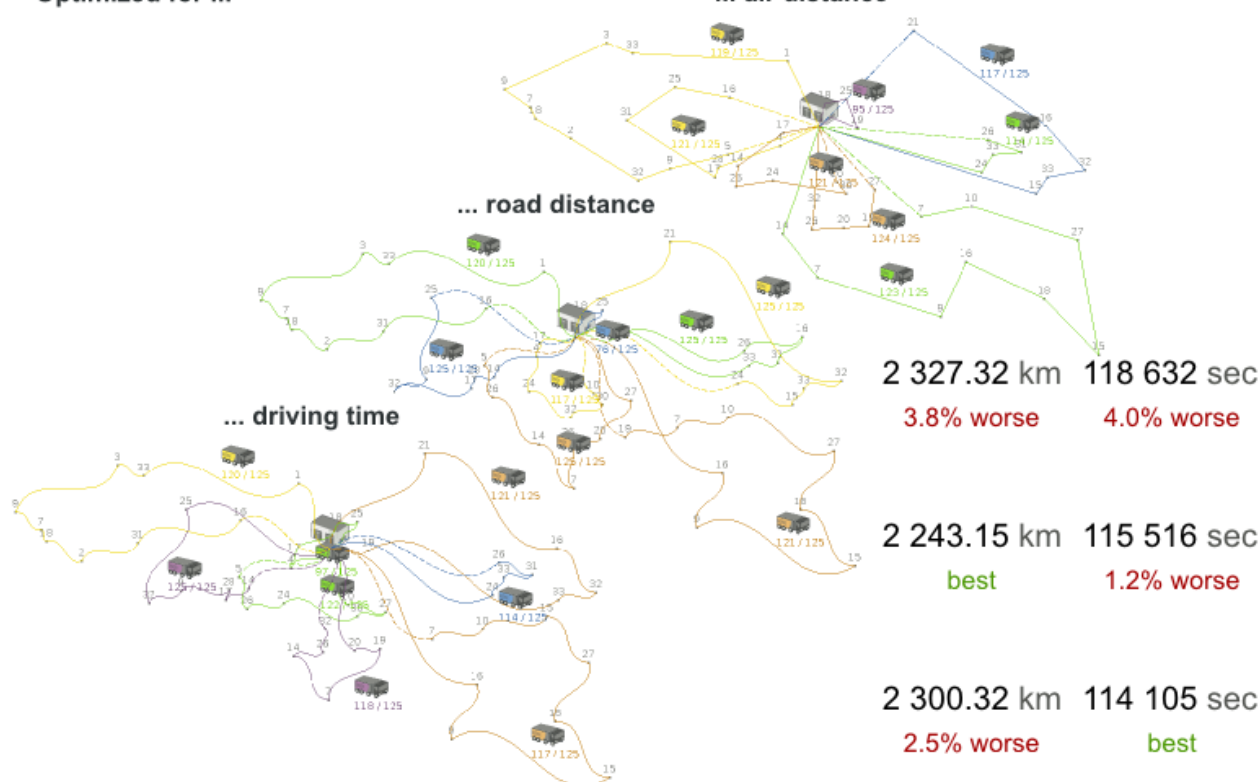

For the optimization algorithm, this does not matter much, as long as the distance between two points can be looked up (and are preferably precalculated). The road cost does not even need to be a distance, it can also be travel time, fuel cost, or a weighted function of those. There are several technologies available to precalculate road costs, such as [GraphHopper](#) (embeddable, offline Java engine), [Open MapQuest](#) (web service) and [Google Maps Client API](#) (web service).

Integration with real maps

Google Maps or GraphHopper (OpenStreetMap) calculate distances, OptaPlanner optimizes the trips.

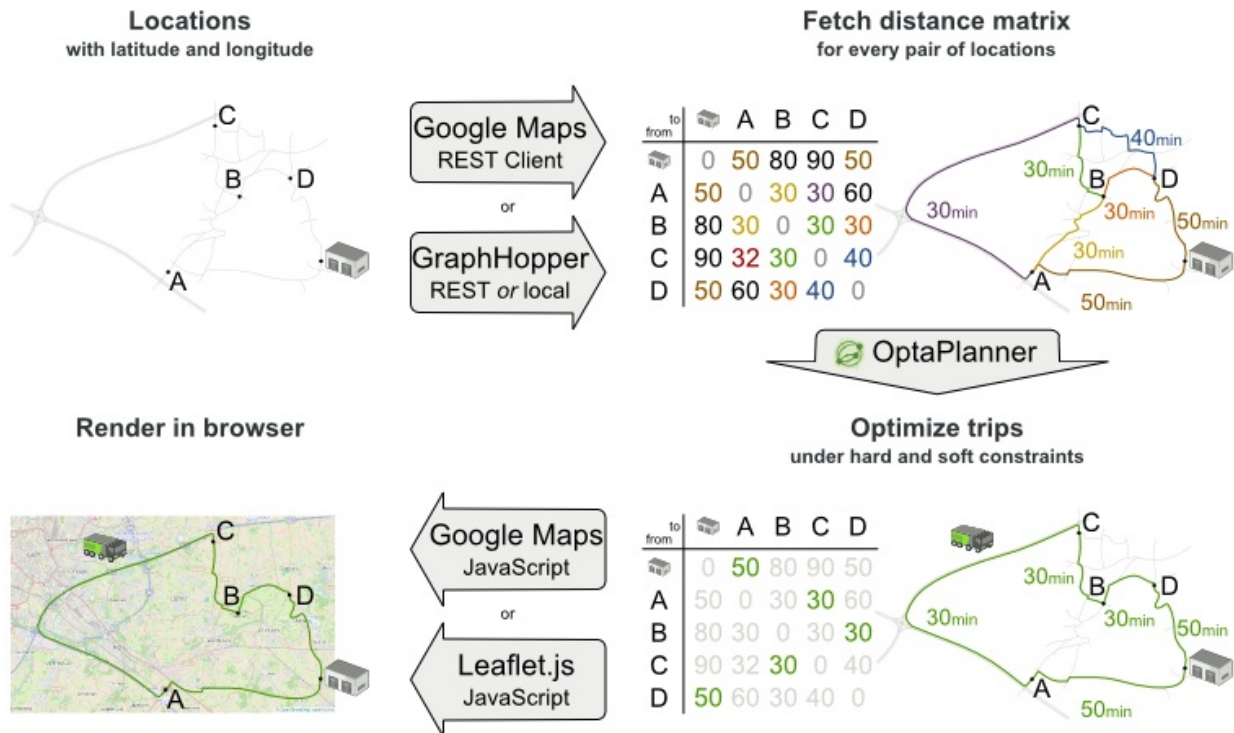

There are also several technologies to render it, such as [Leaflet](#) and [Google Maps for developers](#).

Leaflet.js

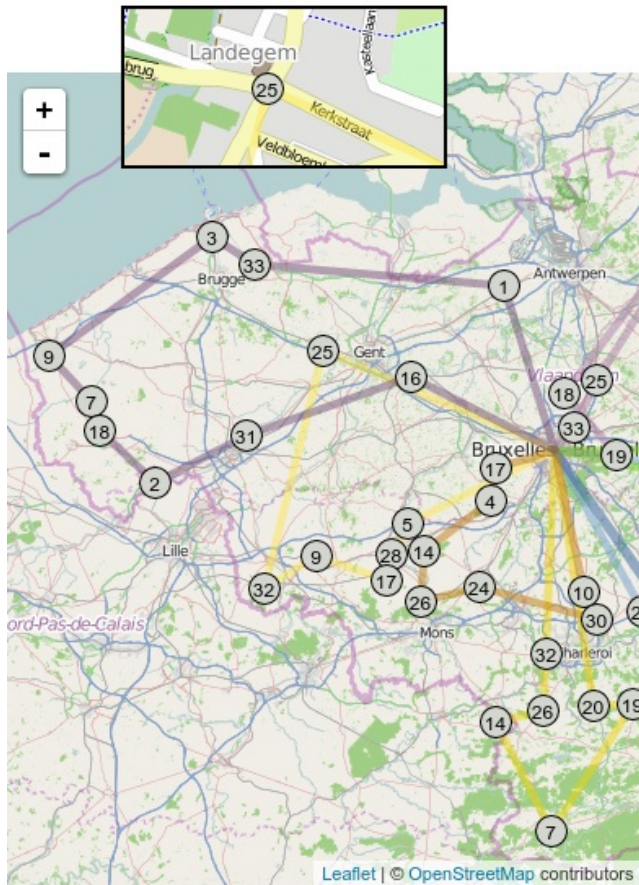

Google Maps

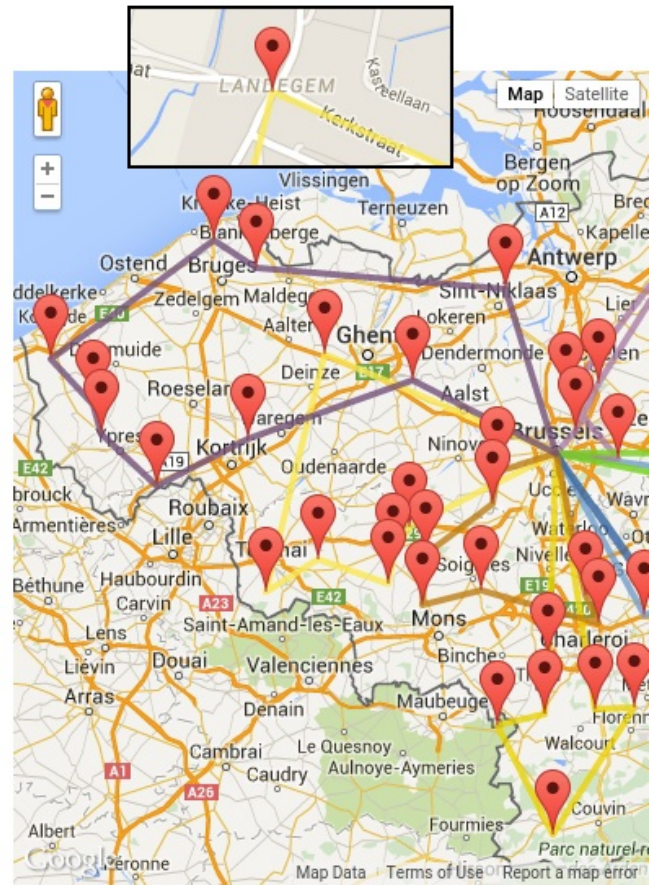

It is even possible to render the actual road routes with GraphHopper or Google Map Directions, but because of route overlaps on highways, it can become harder to see the standstill order:



Take special care that the road costs between two points use the same optimization criteria as the one used in Planner. For example, GraphHopper etc will by default return the fastest route, not the shortest route. Don't use the km (or miles) distances of the fastest GPS routes to optimize the shortest trip in Planner: this leads to a suboptimal solution as shown below:

Road distance triangle inequality

Routes and trips must optimize the same property to avoid suboptimal solutions.

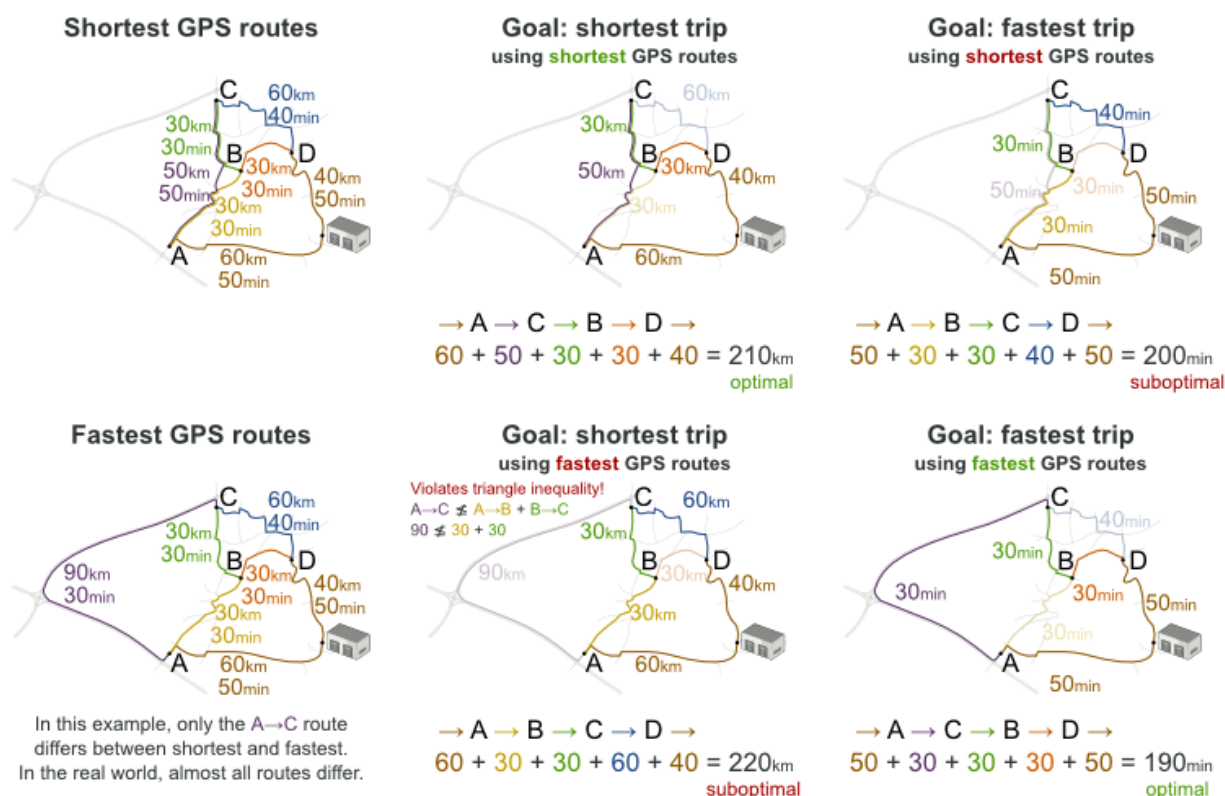

Contrary to popular belief, most users do not want the shortest route: they want the fastest route instead. They prefer highways over normal roads. They prefer normal roads over dirt roads. In the real world, the fastest and shortest route are rarely the same.

31.9. PROJECT JOB SCHEDULING

Schedule all jobs in time and execution mode to minimize project delays. Each job is part of a project. A job can be executed in different ways: each way is an execution mode that implies a different duration but also different resource usages. This is a form of flexible *job shop scheduling*.

Project job scheduling

For each job, choose an execution mode and a start time.

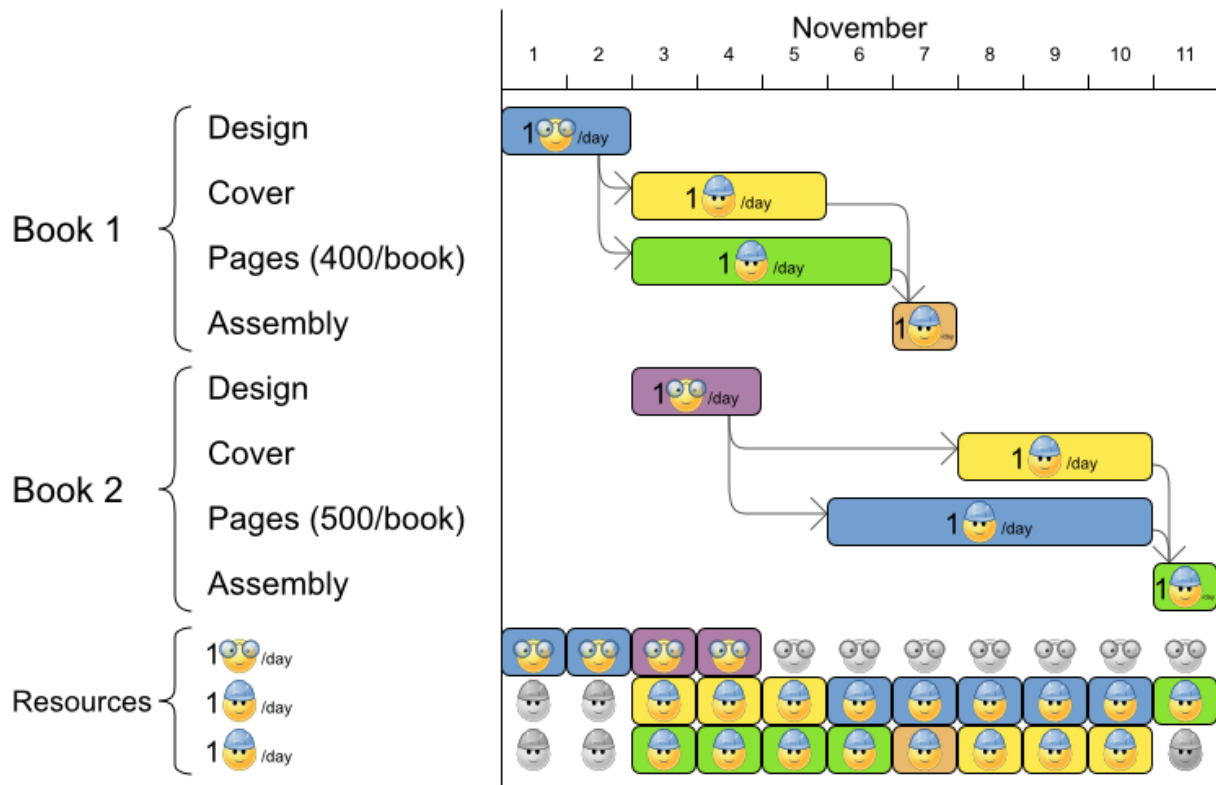

Hard constraints:

- Job precedence: a job can only start when all its predecessor jobs are finished.
- Resource capacity: do not use more resources than available.
 - Resources are local (shared between jobs of the same project) or global (shared between all jobs)
 - Resources are renewable (capacity available per day) or nonrenewable (capacity available for all days)

Medium constraints:

- Total project delay: minimize the duration (makespan) of each project.

Soft constraints:

- Total makespan: minimize the duration of the whole multi-project schedule.

The problem is defined by [the MISTA 2013 challenge](#).

Problem size

Schedule A-1 has 2 projects, 24 jobs, 64 execution modes, 7 resources and 150 resource requirements.

Schedule A-2 has 2 projects, 44 jobs, 124 execution modes, 7 resources and 420 resource requirements.

Schedule A-3 has 2 projects, 64 jobs, 184 execution modes, 7 resources and 630 resource requirements.

Schedule A-4 has 5 projects, 60 jobs, 160 execution modes, 16 resources and 390 resource requirements.

Schedule A-5 has 5 projects, 110 jobs, 310 execution modes, 16 resources and 900 resource requirements.

Schedule A-6 has 5 projects, 160 jobs, 460 execution modes, 16 resources and 1440 resource requirements.

Schedule A-7 has 10 projects, 120 jobs, 320 execution modes, 22 resources and 900 resource requirements.

Schedule A-8 has 10 projects, 220 jobs, 620 execution modes, 22 resources and 1860 resource requirements.

Schedule A-9 has 10 projects, 320 jobs, 920 execution modes, 31 resources and 2880 resource requirements.

Schedule A-10 has 10 projects, 320 jobs, 920 execution modes, 31 resources and 2970 resource requirements.

Schedule B-1 has 10 projects, 120 jobs, 320 execution modes, 31 resources and 900 resource requirements.

Schedule B-2 has 10 projects, 220 jobs, 620 execution modes, 22 resources and 1740 resource requirements.

Schedule B-3 has 10 projects, 320 jobs, 920 execution modes, 31 resources and 3060 resource requirements.

Schedule B-4 has 15 projects, 180 jobs, 480 execution modes, 46 resources and 1530 resource requirements.

Schedule B-5 has 15 projects, 330 jobs, 930 execution modes, 46 resources and 2760 resource requirements.

Schedule B-6 has 15 projects, 480 jobs, 1380 execution modes, 46 resources and 4500 resource requirements.

Schedule B-7 has 20 projects, 240 jobs, 640 execution modes, 61 resources and 1710 resource requirements.

Schedule B-8 has 20 projects, 440 jobs, 1240 execution modes, 42 resources and 3180 resource requirements.

Schedule B-9 has 20 projects, 640 jobs, 1840 execution modes, 61 resources and 5940 resource requirements.

Schedule B-10 has 20 projects, 460 jobs, 1300 execution modes, 42 resources and 4260 resource requirements.

31.10. TASK ASSIGNING

Assign each task to a spot in an employee's queue. Each task has a duration which is affected by the employee's affinity level with the task's customer.

Hard constraints:

- Skill: Each task requires one or more skills. The employee must possess all these skills.

Soft level 0 constraints:

- Critical tasks: Complete critical tasks first, sooner than major and minor tasks.

Soft level 1 constraints:

- Minimize makespan: Reduce the time to complete all tasks.
 - Start with the longest working employee first, then the second longest working employee and so forth, to create fairness and load balancing.

Soft level 2 constraints:

- Major tasks: Complete major tasks as soon as possible, sooner than minor tasks.

Soft level 3 constraints:

- Minor tasks: Complete minor tasks as soon as possible.

Figure 31.9. Value proposition

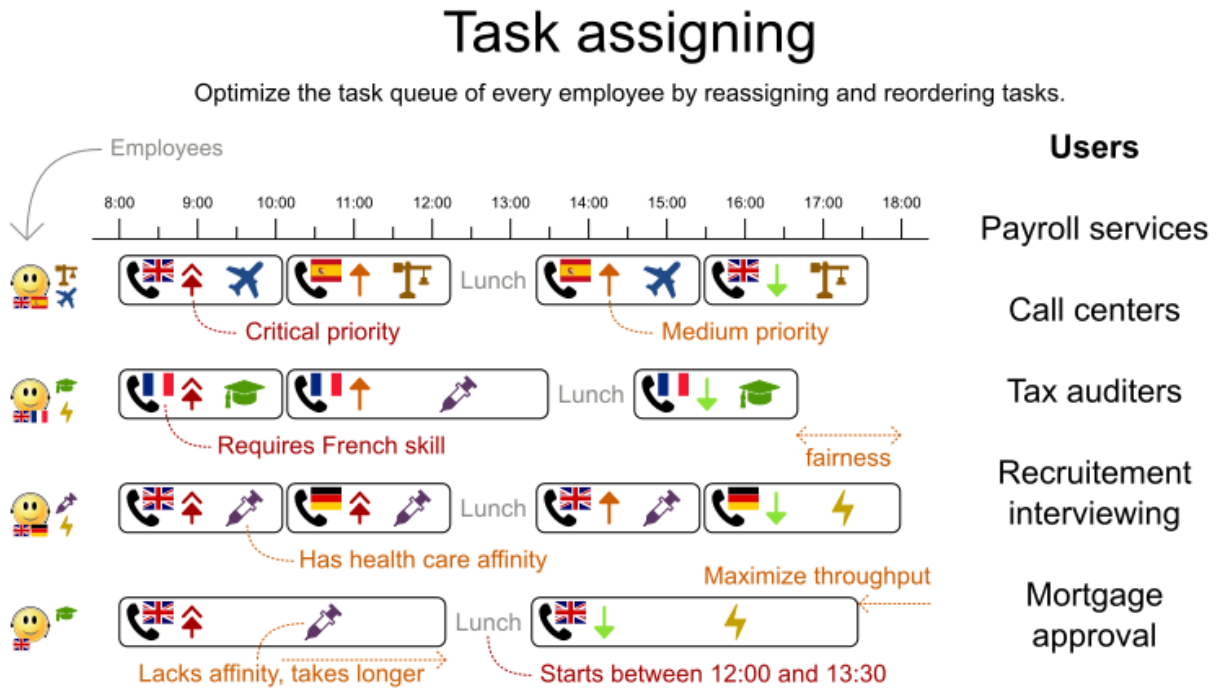

Problem size

24tasks-8employees has 24 tasks, 6 skills, 8 employees, 4 task types and 4 customers with a search space of 10^{30} .

50tasks-5employees has 50 tasks, 5 skills, 5 employees, 10 task types and 10 customers with a search space of 10^{69} .

100tasks-5employees has 100 tasks, 5 skills, 5 employees, 20 task types and 15 customers with a search space of 10^{164} .

500tasks-20employees has 500 tasks, 6 skills, 20 employees, 100 task types and 60 customers with a search space of 10^{1168} .

Figure 31.10. Domain model

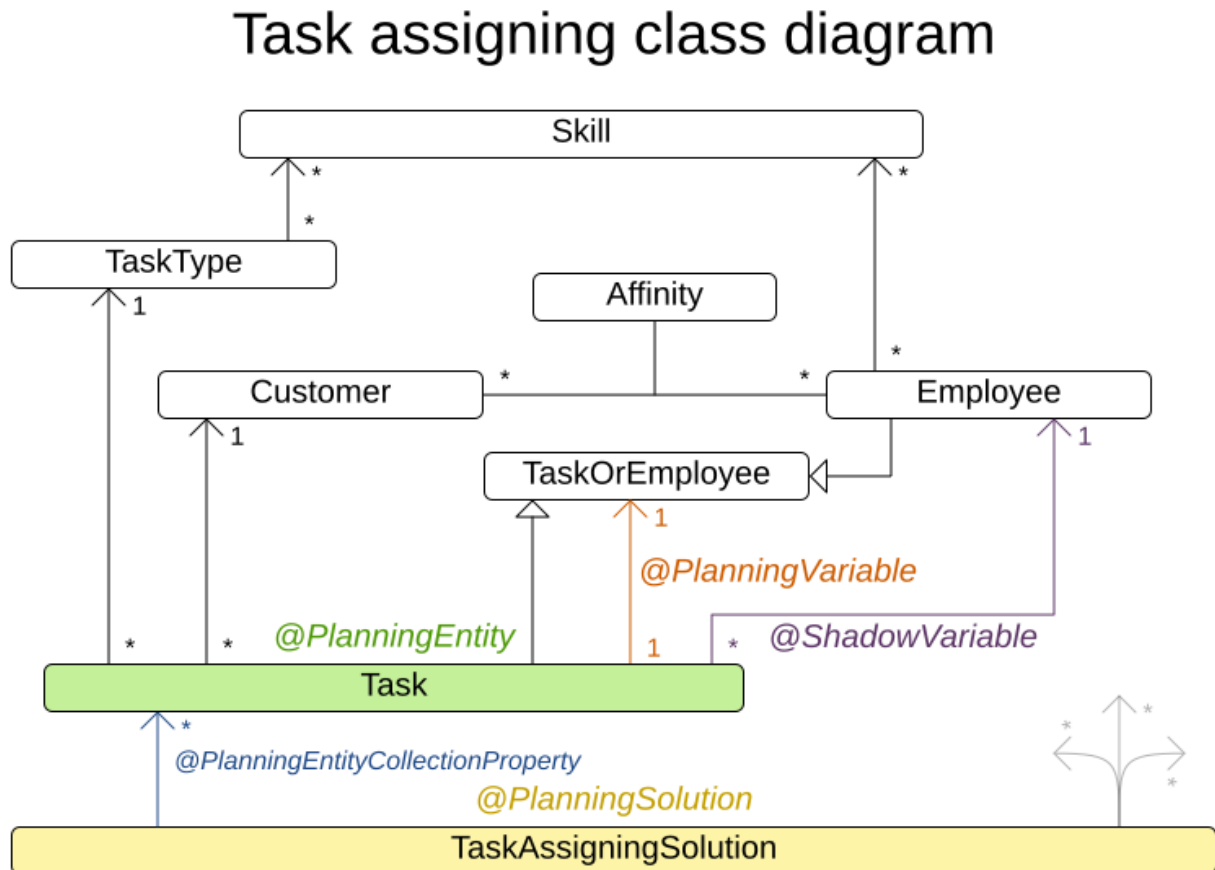

31.11. EXAM TIMETABLING (ITC 2007 TRACK 1 - EXAMINATION)

Schedule each exam into a period and into a room. Multiple exams can share the same room during the same period.

Examination timetabling

Assign each exam a period and a room.

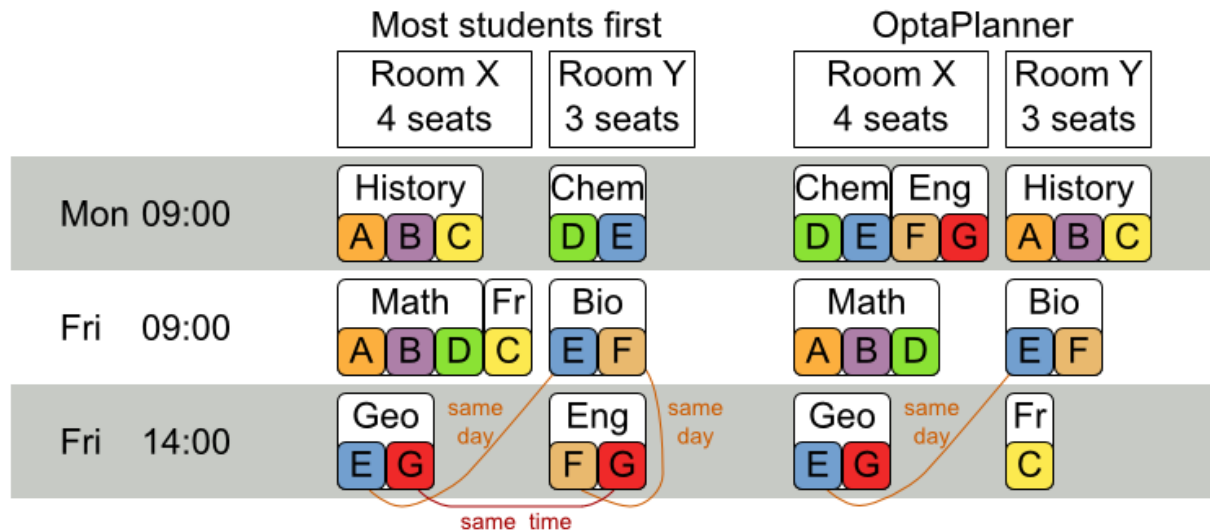
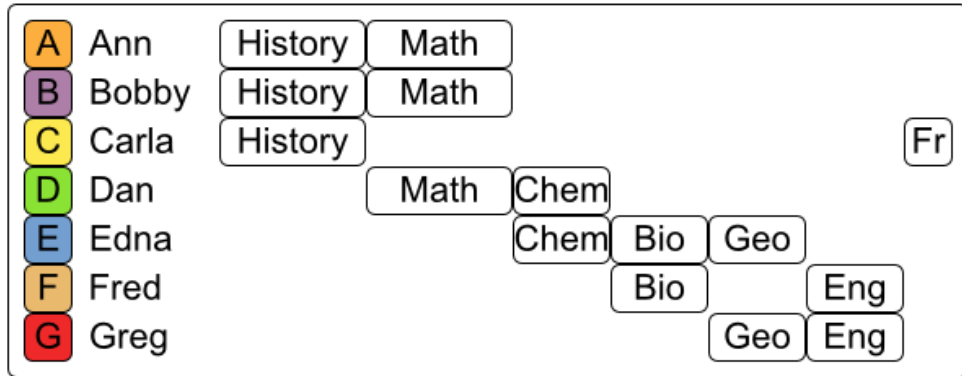

Hard constraints:

- Exam conflict: Two exams that share students must not occur in the same period.
- Room capacity: A room’s seating capacity must suffice at all times.
- Period duration: A period’s duration must suffice for all of its exams.
- Period related hard constraints (specified per dataset):
 - Coincidence: Two specified exams must use the same period (but possibly another room).
 - Exclusion: Two specified exams must not use the same period.
 - After: A specified exam must occur in a period after another specified exam’s period.
- Room related hard constraints (specified per dataset):
 - Exclusive: One specified exam should not have to share its room with any other exam.

Soft constraints (each of which has a parametrized penalty):

- The same student should not have two exams in a row.
- The same student should not have two exams on the same day.
- Period spread: Two exams that share students should be a number of periods apart.
- Mixed durations: Two exams that share a room should not have different durations.

- Front load: Large exams should be scheduled earlier in the schedule.
- Period penalty (specified per dataset): Some periods have a penalty when used.
- Room penalty (specified per dataset): Some rooms have a penalty when used.

It uses large test data sets of real-life universities.

The problem is defined by [the International Timetabling Competition 2007 track 1](#). Geoffrey De Smet finished 4th in that competition with a very early version of Planner. Many improvements have been made since then.

Problem Size

exam_comp_set1 has 7883 students, 607 exams, 54 periods, 7 rooms, 12 period constraints and 0 room constraints with a search space of 10^{1564} .
 exam_comp_set2 has 12484 students, 870 exams, 40 periods, 49 rooms, 12 period constraints and 2 room constraints with a search space of 10^{2864} .
 exam_comp_set3 has 16365 students, 934 exams, 36 periods, 48 rooms, 168 period constraints and 15 room constraints with a search space of 10^{3023} .
 exam_comp_set4 has 4421 students, 273 exams, 21 periods, 1 rooms, 40 period constraints and 0 room constraints with a search space of 10^{360} .
 exam_comp_set5 has 8719 students, 1018 exams, 42 periods, 3 rooms, 27 period constraints and 0 room constraints with a search space of 10^{2138} .
 exam_comp_set6 has 7909 students, 242 exams, 16 periods, 8 rooms, 22 period constraints and 0 room constraints with a search space of 10^{509} .
 exam_comp_set7 has 13795 students, 1096 exams, 80 periods, 15 rooms, 28 period constraints and 0 room constraints with a search space of 10^{3374} .
 exam_comp_set8 has 7718 students, 598 exams, 80 periods, 8 rooms, 20 period constraints and 1 room constraints with a search space of 10^{1678} .

31.11.1. Domain model for Exam timetabling

The following diagram shows the main examination domain classes:

Figure 31.11. Examination domain class diagram

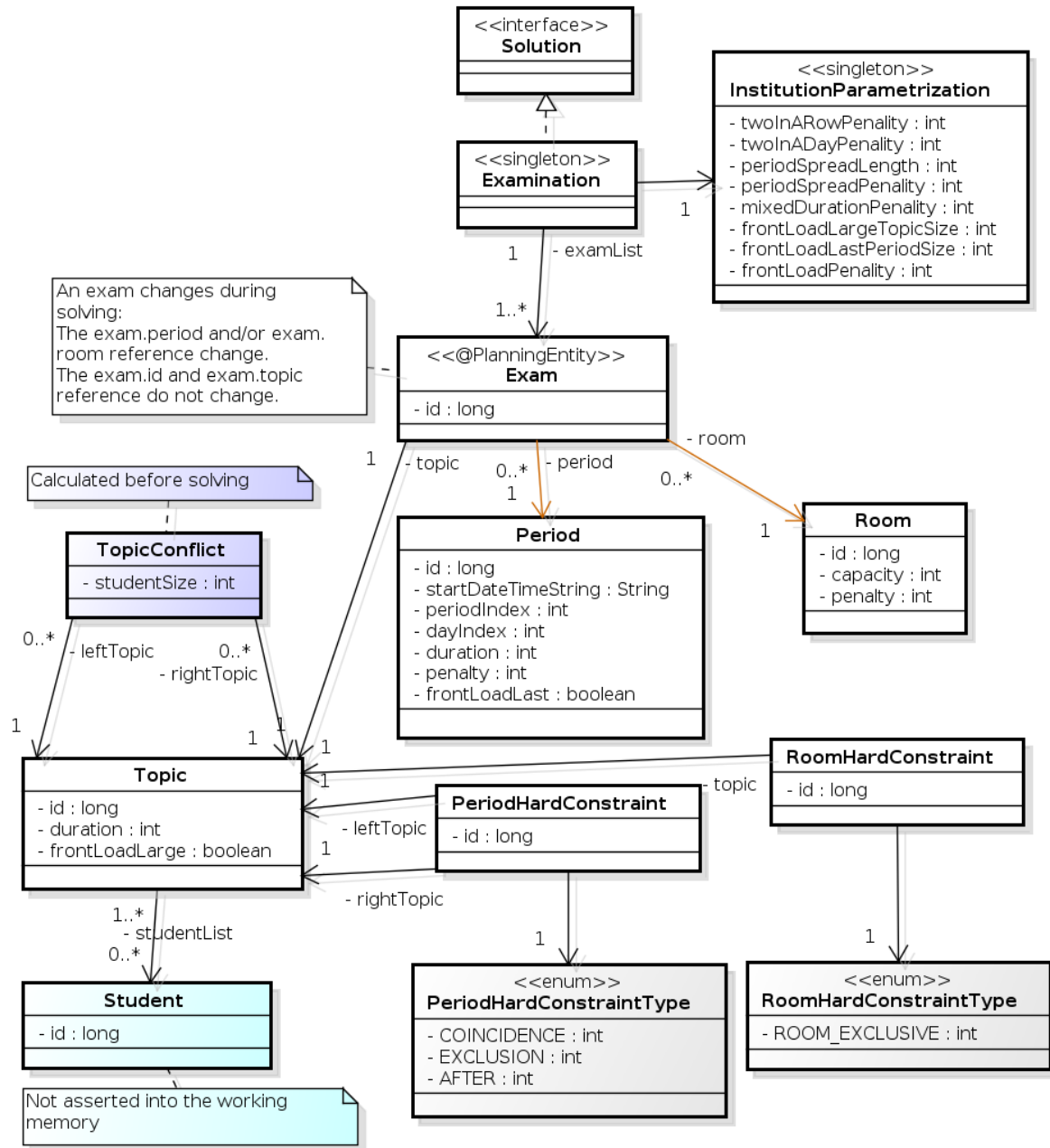

Notice that we’ve split up the exam concept into an **Exam** class and a **Topic** class. The **Exam** instances change during solving (this is the planning entity class), when their period or room property changes. The **Topic**, **Period** and **Room** instances never change during solving (these are problem facts, just like some other classes).

31.12. NURSE ROSTERING (INRC 2010)

For each shift, assign a nurse to work that shift.

Employee shift rostering

Populate each work shift with a nurse.

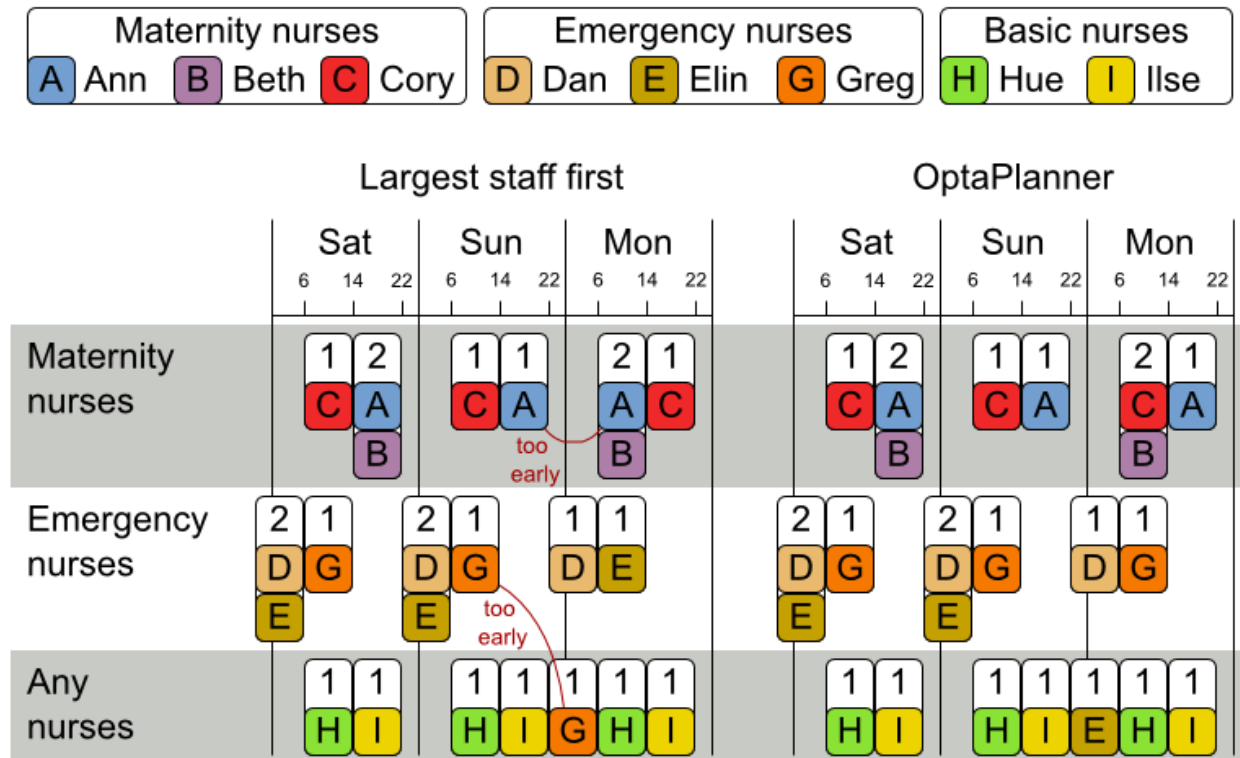

Hard constraints:

- **No unassigned shifts** (built-in): Every shift need to be assigned to an employee.
- **Shift conflict**: An employee can have only one shift per day.

Soft constraints:

- Contract obligations. The business frequently violates these, so they decided to define these as soft constraints instead of hard constraints.
 - **Minimum and maximum assignments** Each employee needs to work more than x shifts and less than y shifts (depending on their contract).
 - **Minimum and maximum consecutive working days** Each employee needs to work between x and y days in a row (depending on their contract).
 - **Minimum and maximum consecutive free days** Each employee needs to be free between x and y days in a row (depending on their contract).
 - **Minimum and maximum consecutive working weekends** Each employee needs to work between x and y weekends in a row (depending on their contract).
 - **Complete weekends**: Each employee needs to work every day in a weekend or not at all.
 - **Identical shift types during weekend** Each weekend shift for the same weekend of the same employee must be the same shift type.

- **Unwanted patterns:** A combination of unwanted shift types in a row. For example: a late shift followed by an early shift followed by a late shift.
- Employee wishes:
 - **Day on request:** An employee wants to work on a specific day.
 - **Day off request:** An employee does not want to work on a specific day.
 - **Shift on request:** An employee wants to be assigned to a specific shift.
 - **Shift off request:** An employee does not want to be assigned to a specific shift.
- **Alternative skill:** An employee assigned to a skill should have a proficiency in every skill required by that shift.

The problem is defined by [the International Nurse Rostering Competition 2010](#).

Figure 31.12. Value proposition

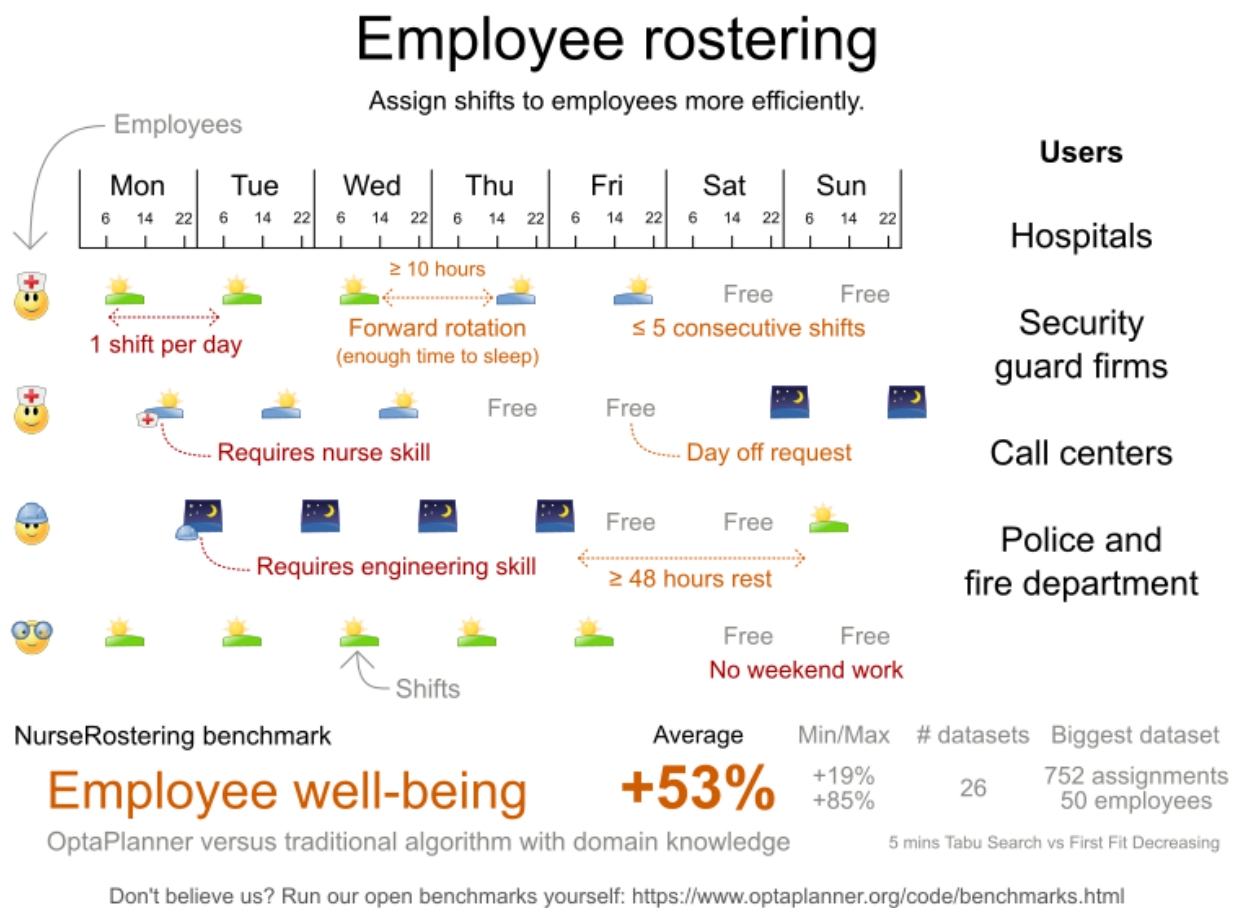

Problem size

There are three dataset types:

- sprint: must be solved in seconds.
- medium: must be solved in minutes.
- long: must be solved in hours.

medium03 has 1 skills, 4 shiftTypes, 0 patterns, 4 contracts, 31 employees, 28 shiftDates, 608 shiftAssignments and 403 requests with a search space of 10^9 .

medium04 has 1 skills, 4 shiftTypes, 0 patterns, 4 contracts, 31 employees, 28 shiftDates, 608 shiftAssignments and 403 requests with a search space of 10^9 .

medium05 has 1 skills, 4 shiftTypes, 0 patterns, 4 contracts, 31 employees, 28 shiftDates, 608 shiftAssignments and 403 requests with a search space of 10^9 .

medium_hint01 has 1 skills, 4 shiftTypes, 7 patterns, 4 contracts, 30 employees, 28 shiftDates, 428 shiftAssignments and 390 requests with a search space of 10^6 .

medium_hint02 has 1 skills, 4 shiftTypes, 7 patterns, 3 contracts, 30 employees, 28 shiftDates, 428 shiftAssignments and 390 requests with a search space of 10^6 .

medium_hint03 has 1 skills, 4 shiftTypes, 7 patterns, 4 contracts, 30 employees, 28 shiftDates, 428 shiftAssignments and 390 requests with a search space of 10^6 .

medium_late01 has 1 skills, 4 shiftTypes, 7 patterns, 4 contracts, 30 employees, 28 shiftDates, 424 shiftAssignments and 390 requests with a search space of 10^6 .

medium_late02 has 1 skills, 4 shiftTypes, 7 patterns, 3 contracts, 30 employees, 28 shiftDates, 428 shiftAssignments and 390 requests with a search space of 10^6 .

medium_late03 has 1 skills, 4 shiftTypes, 0 patterns, 4 contracts, 30 employees, 28 shiftDates, 428 shiftAssignments and 390 requests with a search space of 10^6 .

medium_late04 has 1 skills, 4 shiftTypes, 7 patterns, 3 contracts, 30 employees, 28 shiftDates, 416 shiftAssignments and 390 requests with a search space of 10^6 .

medium_late05 has 2 skills, 5 shiftTypes, 7 patterns, 4 contracts, 30 employees, 28 shiftDates, 452 shiftAssignments and 390 requests with a search space of 10^6 .

long01 has 2 skills, 5 shiftTypes, 3 patterns, 3 contracts, 49 employees, 28 shiftDates, 740 shiftAssignments and 735 requests with a search space of 10^{12} .

long02 has 2 skills, 5 shiftTypes, 3 patterns, 3 contracts, 49 employees, 28 shiftDates, 740 shiftAssignments and 735 requests with a search space of 10^{12} .

long03 has 2 skills, 5 shiftTypes, 3 patterns, 3 contracts, 49 employees, 28 shiftDates, 740 shiftAssignments and 735 requests with a search space of 10^{12} .

long04 has 2 skills, 5 shiftTypes, 3 patterns, 3 contracts, 49 employees, 28 shiftDates, 740 shiftAssignments and 735 requests with a search space of 10^{12} .

long05 has 2 skills, 5 shiftTypes, 3 patterns, 3 contracts, 49 employees, 28 shiftDates, 740 shiftAssignments and 735 requests with a search space of 10^{12} .

long_hint01 has 2 skills, 5 shiftTypes, 9 patterns, 3 contracts, 50 employees, 28 shiftDates, 740 shiftAssignments and 0 requests with a search space of 10^{12} .

long_hint02 has 2 skills, 5 shiftTypes, 7 patterns, 3 contracts, 50 employees, 28 shiftDates, 740 shiftAssignments and 0 requests with a search space of 10^{12} .

long_hint03 has 2 skills, 5 shiftTypes, 7 patterns, 3 contracts, 50 employees, 28 shiftDates, 740 shiftAssignments and 0 requests with a search space of 10^{12} .

long_late01 has 2 skills, 5 shiftTypes, 9 patterns, 3 contracts, 50 employees, 28 shiftDates, 752 shiftAssignments and 0 requests with a search space of 10^{12} .

long_late02 has 2 skills, 5 shiftTypes, 9 patterns, 4 contracts, 50 employees, 28 shiftDates, 752 shiftAssignments and 0 requests with a search space of 10^{12} .

long_late03 has 2 skills, 5 shiftTypes, 9 patterns, 3 contracts, 50 employees, 28 shiftDates, 752 shiftAssignments and 0 requests with a search space of 10^{12} .

long_late04 has 2 skills, 5 shiftTypes, 9 patterns, 4 contracts, 50 employees, 28 shiftDates, 752 shiftAssignments and 0 requests with a search space of 10^{12} .

long_late05 has 2 skills, 5 shiftTypes, 9 patterns, 3 contracts, 50 employees, 28 shiftDates, 740 shiftAssignments and 0 requests with a search space of 10^{12} .

Figure 31.13. Domain model

Nurse rostering class diagram

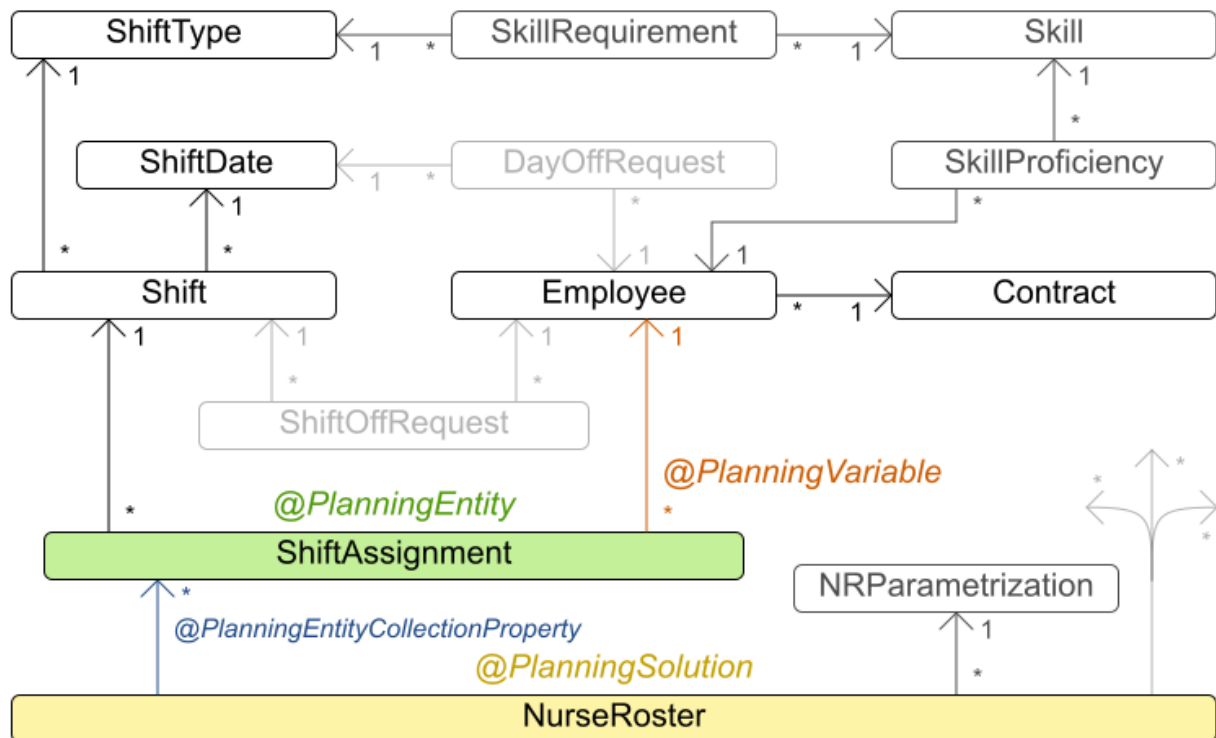

31.13. TRAVELING TOURNAMENT PROBLEM (TTP)

Schedule matches between n teams.

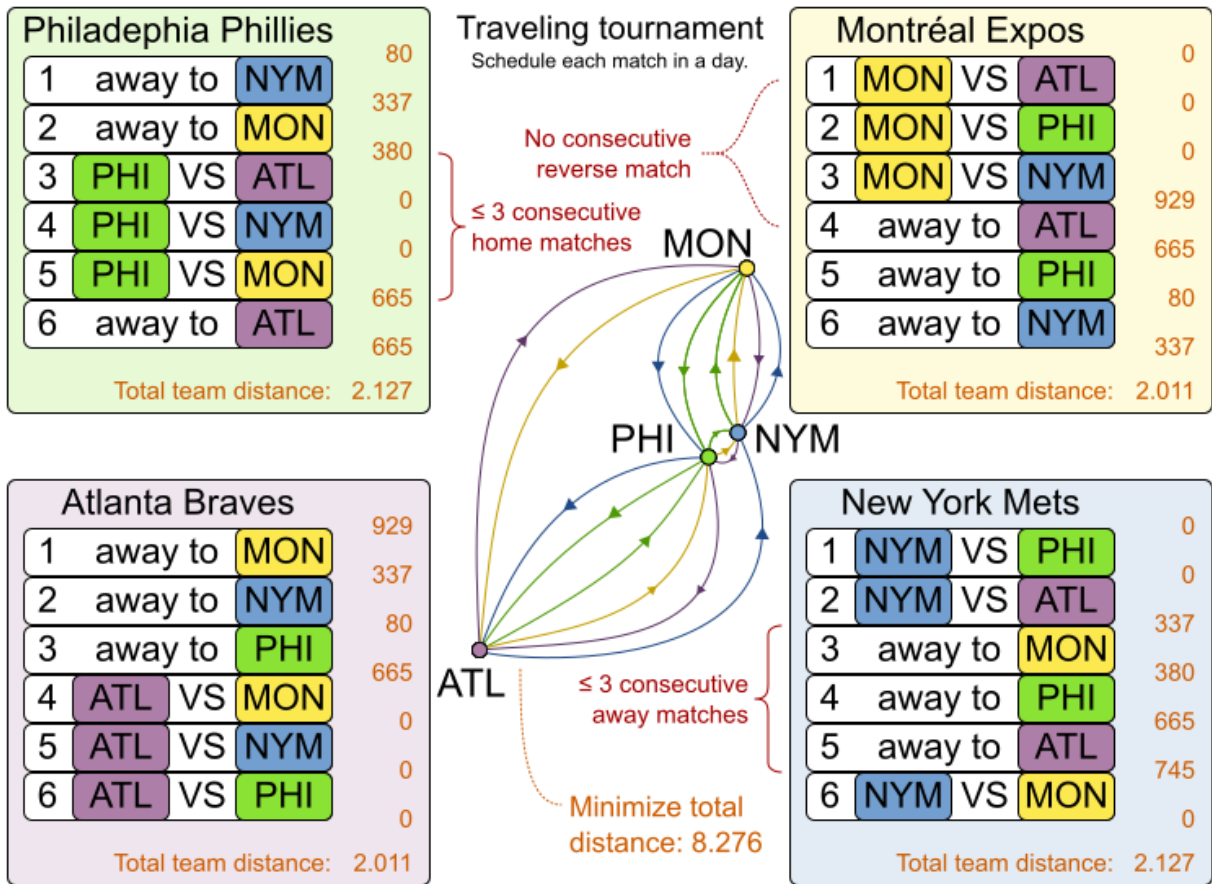

Hard constraints:

- Each team plays twice against every other team: once home and once away.
- Each team has exactly one match on each timeslot.
- No team must have more than three consecutive home or three consecutive away matches.
- No repeaters: no two consecutive matches of the same two opposing teams.

Soft constraints:

- Minimize the total distance traveled by all teams.

The problem is defined on [Michael Trick's website](#) (which contains the world records too).

Problem size

| | | |
|---------|--|---------------------|
| 1-nl04 | has 6 days, 4 teams and 12 matches with a search space of | 10 ⁵ . |
| 1-nl06 | has 10 days, 6 teams and 30 matches with a search space of | 10 ¹⁹ . |
| 1-nl08 | has 14 days, 8 teams and 56 matches with a search space of | 10 ⁴³ . |
| 1-nl10 | has 18 days, 10 teams and 90 matches with a search space of | 10 ⁷⁹ . |
| 1-nl12 | has 22 days, 12 teams and 132 matches with a search space of | 10 ¹²⁶ . |
| 1-nl14 | has 26 days, 14 teams and 182 matches with a search space of | 10 ¹⁸⁶ . |
| 1-nl16 | has 30 days, 16 teams and 240 matches with a search space of | 10 ²⁵⁹ . |
| 2-bra24 | has 46 days, 24 teams and 552 matches with a search space of | 10 ⁶⁹² . |
| 3-nfl16 | has 30 days, 16 teams and 240 matches with a search space of | 10 ²⁵⁹ . |
| 3-nfl18 | has 34 days, 18 teams and 306 matches with a search space of | 10 ³⁴⁶ . |

3-nfl20 has 38 days, 20 teams and 380 matches with a search space of 10^{447} .
 3-nfl22 has 42 days, 22 teams and 462 matches with a search space of 10^{562} .
 3-nfl24 has 46 days, 24 teams and 552 matches with a search space of 10^{692} .
 3-nfl26 has 50 days, 26 teams and 650 matches with a search space of 10^{838} .
 3-nfl28 has 54 days, 28 teams and 756 matches with a search space of 10^{999} .
 3-nfl30 has 58 days, 30 teams and 870 matches with a search space of 10^{1175} .
 3-nfl32 has 62 days, 32 teams and 992 matches with a search space of 10^{1367} .
 4-super04 has 6 days, 4 teams and 12 matches with a search space of 10^5 .
 4-super06 has 10 days, 6 teams and 30 matches with a search space of 10^{19} .
 4-super08 has 14 days, 8 teams and 56 matches with a search space of 10^{43} .
 4-super10 has 18 days, 10 teams and 90 matches with a search space of 10^{79} .
 4-super12 has 22 days, 12 teams and 132 matches with a search space of 10^{126} .
 4-super14 has 26 days, 14 teams and 182 matches with a search space of 10^{186} .
 5-galaxy04 has 6 days, 4 teams and 12 matches with a search space of 10^5 .
 5-galaxy06 has 10 days, 6 teams and 30 matches with a search space of 10^{19} .
 5-galaxy08 has 14 days, 8 teams and 56 matches with a search space of 10^{43} .
 5-galaxy10 has 18 days, 10 teams and 90 matches with a search space of 10^{79} .
 5-galaxy12 has 22 days, 12 teams and 132 matches with a search space of 10^{126} .
 5-galaxy14 has 26 days, 14 teams and 182 matches with a search space of 10^{186} .
 5-galaxy16 has 30 days, 16 teams and 240 matches with a search space of 10^{259} .
 5-galaxy18 has 34 days, 18 teams and 306 matches with a search space of 10^{346} .
 5-galaxy20 has 38 days, 20 teams and 380 matches with a search space of 10^{447} .
 5-galaxy22 has 42 days, 22 teams and 462 matches with a search space of 10^{562} .
 5-galaxy24 has 46 days, 24 teams and 552 matches with a search space of 10^{692} .
 5-galaxy26 has 50 days, 26 teams and 650 matches with a search space of 10^{838} .
 5-galaxy28 has 54 days, 28 teams and 756 matches with a search space of 10^{999} .
 5-galaxy30 has 58 days, 30 teams and 870 matches with a search space of 10^{1175} .
 5-galaxy32 has 62 days, 32 teams and 992 matches with a search space of 10^{1367} .
 5-galaxy34 has 66 days, 34 teams and 1122 matches with a search space of 10^{1576} .
 5-galaxy36 has 70 days, 36 teams and 1260 matches with a search space of 10^{1801} .
 5-galaxy38 has 74 days, 38 teams and 1406 matches with a search space of 10^{2042} .
 5-galaxy40 has 78 days, 40 teams and 1560 matches with a search space of 10^{2301} .

31.14. CHEAP TIME SCHEDULING

Schedule all tasks in time and on a machine to minimize power cost. Power prices differs in time. This is a form of *job shop scheduling*.

Hard constraints:

- Start time limits: Each task must start between its earliest start and latest start limit.
- Maximum capacity: The maximum capacity for each resource for each machine must not be exceeded.
- Startup and shutdown: Each machine must be active in the periods during which it has assigned tasks. Between tasks it is allowed to be idle to avoid startup and shutdown costs.

Medium constraints:

- Power cost: Minimize the total power cost of the whole schedule.
 - Machine power cost: Each active or idle machine consumes power, which infers a power cost (depending on the power price during that time).

- Task power cost: Each task consumes power too, which infers a power cost (depending on the power price during its time).
- Machine startup and shutdown cost: Every time a machine starts up or shuts down, an extra cost is inflicted.

Soft constraints (addendum to the original problem definition):

- Start early: Prefer starting a task sooner rather than later.

The problem is defined by [the ICON challenge](#).

Problem size

sample01 has 3 resources, 2 machines, 288 periods and 25 tasks with a search space of 10^{53} .

sample02 has 3 resources, 2 machines, 288 periods and 50 tasks with a search space of 10^{114} .

sample03 has 3 resources, 2 machines, 288 periods and 100 tasks with a search space of 10^{226} .

sample04 has 3 resources, 5 machines, 288 periods and 100 tasks with a search space of 10^{266} .

sample05 has 3 resources, 2 machines, 288 periods and 250 tasks with a search space of 10^{584} .

sample06 has 3 resources, 5 machines, 288 periods and 250 tasks with a search space of 10^{673} .

sample07 has 3 resources, 2 machines, 288 periods and 1000 tasks with a search space of 10^{2388} .

sample08 has 3 resources, 5 machines, 288 periods and 1000 tasks with a search space of 10^{2748} .

sample09 has 4 resources, 20 machines, 288 periods and 2000 tasks with a search space of 10^{6668} .

instance00 has 1 resources, 10 machines, 288 periods and 200 tasks with a search space of 10^{595} .

instance01 has 1 resources, 10 machines, 288 periods and 200 tasks with a search space of 10^{599} .

instance02 has 1 resources, 10 machines, 288 periods and 200 tasks with a search space of 10^{599} .

instance03 has 1 resources, 10 machines, 288 periods and 200 tasks with a search space of 10^{591} .

instance04 has 1 resources, 10 machines, 288 periods and 200 tasks with a search space of 10^{590} .

instance05 has 2 resources, 25 machines, 288 periods and 200 tasks with a search space of 10^{667} .

instance06 has 2 resources, 25 machines, 288 periods and 200 tasks with a search space of 10^{660} .

instance07 has 2 resources, 25 machines, 288 periods and 200 tasks with a search space of 10^{662} .

instance08 has 2 resources, 25 machines, 288 periods and 200 tasks with a search space of 10^{651} .

instance09 has 2 resources, 25 machines, 288 periods and 200 tasks with a search space of 10^{659} .

instance10 has 2 resources, 20 machines, 288 periods and 500 tasks with a search space of 10^{1657} .

instance11 has 2 resources, 20 machines, 288 periods and 500 tasks with a search space of 10^{1644} .

instance12 has 2 resources, 20 machines, 288 periods and 500 tasks with a search space of 10^{1637} .

instance13 has 2 resources, 20 machines, 288 periods and 500 tasks with a search space of 10^{1659} .

instance14 has 2 resources, 20 machines, 288 periods and 500 tasks with a search space of 10^{1643} .

instance15 has 3 resources, 40 machines, 288 periods and 500 tasks with a search space of 10^{1782} .

instance16 has 3 resources, 40 machines, 288 periods and 500 tasks with a search space of 10^{1778} .

instance17 has 3 resources, 40 machines, 288 periods and 500 tasks with a search space of 10^{1764} .

instance18 has 3 resources, 40 machines, 288 periods and 500 tasks with a search space of 10^{1769} .

instance19 has 3 resources, 40 machines, 288 periods and 500 tasks with a search space of 10^{1778} .

instance20 has 3 resources, 50 machines, 288 periods and 1000 tasks with a search space of 10^{3689} .

instance21 has 3 resources, 50 machines, 288 periods and 1000 tasks with a search space of 10^{3678} .

instance22 has 3 resources, 50 machines, 288 periods and 1000 tasks with a search space of 10^{3706} .

instance23 has 3 resources, 50 machines, 288 periods and 1000 tasks with a search space of 10^{3676} .

instance24 has 3 resources, 50 machines, 288 periods and 1000 tasks with a search space of 10^{3681} .

instance25 has 3 resources, 60 machines, 288 periods and 1000 tasks with a search space of 10^{3774} .

instance26 has 3 resources, 60 machines, 288 periods and 1000 tasks with a search space of 10^{3737} .

instance27 has 3 resources, 60 machines, 288 periods and 1000 tasks with a search space of 10^{3744} .

instance28 has 3 resources, 60 machines, 288 periods and 1000 tasks with a search space of 10^{3731} .

instance29 has 3 resources, 60 machines, 288 periods and 1000 tasks with a search space of 10^{3746} .

instance30 has 4 resources, 70 machines, 288 periods and 2000 tasks with a search space of 10^{7718} .

instance31 has 4 resources, 70 machines, 288 periods and 2000 tasks with a search space of 10^{7740} .

instance32 has 4 resources, 70 machines, 288 periods and 2000 tasks with a search space of 10^{7686} .

instance33 has 4 resources, 70 machines, 288 periods and 2000 tasks with a search space of 10^{7672} .

instance34 has 4 resources, 70 machines, 288 periods and 2000 tasks with a search space of 10^{7695} .

instance35 has 4 resources, 80 machines, 288 periods and 2000 tasks with a search space of 10^{7807} .

instance36 has 4 resources, 80 machines, 288 periods and 2000 tasks with a search space of 10^{7814} .

instance37 has 4 resources, 80 machines, 288 periods and 2000 tasks with a search space of 10^{7764} .

instance38 has 4 resources, 80 machines, 288 periods and 2000 tasks with a search space of 10^{7736} .

instance39 has 4 resources, 80 machines, 288 periods and 2000 tasks with a search space of 10^{7783} .

instance40 has 4 resources, 90 machines, 288 periods and 4000 tasks with a search space of 10^{15976} .

instance41 has 4 resources, 90 machines, 288 periods and 4000 tasks with a search space of 10^{15935} .

instance42 has 4 resources, 90 machines, 288 periods and 4000 tasks with a search space of 10^{15887} .

instance43 has 4 resources, 90 machines, 288 periods and 4000 tasks with a search space of 10^{15896} .

instance44 has 4 resources, 90 machines, 288 periods and 4000 tasks with a search space of 10^{15885} .

instance45 has 4 resources, 100 machines, 288 periods and 5000 tasks with a search space of 10^{20173} .

instance46 has 4 resources, 100 machines, 288 periods and 5000 tasks with a search space of 10^{20132} .

instance47 has 4 resources, 100 machines, 288 periods and 5000 tasks with a search space of 10^{20126} .

instance48 has 4 resources, 100 machines, 288 periods and 5000 tasks with a search space of 10^{20110} .

instance49 has 4 resources, 100 machines, 288 periods and 5000 tasks with a search space of 10^{20078} .

31.15. INVESTMENT ASSET CLASS ALLOCATION (PORTFOLIO OPTIMIZATION)

Decide the relative quantity to invest in each asset class.

Hard constraints:

- Risk maximum: the total standard deviation must not be higher than the standard deviation maximum.
 - Total standard deviation calculation takes asset class correlations into account by applying [Markowitz Portfolio Theory](#).
- Region maximum: Each region has a quantity maximum.
- Sector maximum: Each sector has a quantity maximum.

Soft constraints:

- Maximize expected return.

Problem size

de_smet_1 has 1 regions, 3 sectors and 11 asset classes with a search space of 10^4 .

irrinki_1 has 2 regions, 3 sectors and 6 asset classes with a search space of 10^3 .

Larger datasets have not been created or tested yet, but should not pose a problem. A good source of data is [this Asset Correlation website](#).

31.16. CONFERENCE SCHEDULING

Assign each conference talk to a timeslot and a room. Timeslots can overlap. Read/write to/from an ***.xlsx** file that can be edited with LibreOffice or Excel too.

Hard constraints:

- Talk type of timeslot: The type of a talk must match the timeslot's talk type.
- Room unavailable timeslots: A talk's room must be available during the talk's timeslot.
- Room conflict: Two talks can't use the same room during overlapping timeslots.
- Speaker unavailable timeslots: Every talk's speaker must be available during the talk's timeslot.
- Speaker conflict: Two talks can't share a speaker during overlapping timeslots.
- Generic purpose timeslot and room tags
 - Speaker required timeslot tag: If a speaker has a required timeslot tag, then all his/her talks must be assigned to a timeslot with that tag.
 - Speaker prohibited timeslot tag: If a speaker has a prohibited timeslot tag, then all his/her talks cannot be assigned to a timeslot with that tag.
 - Talk required timeslot tag: If a talk has a required timeslot tag, then it must be assigned to a timeslot with that tag.
 - Talk prohibited timeslot tag: If a talk has a prohibited timeslot tag, then it cannot be assigned to a timeslot with that tag.
 - Speaker required room tag: If a speaker has a required room tag, then all his/her talks must be assigned to a room with that tag.
 - Speaker prohibited room tag: If a speaker has a prohibited room tag, then all his/her talks cannot be assigned to a room with that tag.
 - Talk required room tag: If a talk has a required room tag, then it must be assigned to a room with that tag.
 - Talk prohibited room tag: If a talk has a prohibited room tag, then it cannot be assigned to a room with that tag.
- Talk mutually-exclusive-talks tag: Talks that share such a tag must not be scheduled in overlapping timeslots.
- Talk prerequisite talks: A talk must be scheduled after all its prerequisite talks.

Soft constraints:

- Theme track conflict: Minimize the number of talks that share a same theme tag during overlapping timeslots.
- Sector conflict: Minimize the number of talks that share a same sector tag during overlapping timeslots.
- Content audience level flow violation: For every content tag, schedule the introductory talks before the advanced talks.
- Audience level diversity: For every timeslot, maximize the number of talks with a different audience level.
- Language diversity: For every timeslot, maximize the number of talks with a different language.

- Generic purpose timeslot and room tags
 - Speaker preferred timeslot tag: If a speaker has a preferred timeslot tag, then all his/her talks should be assigned to a timeslot with that tag.
 - Speaker undesired timeslot tag: If a speaker has an undesired timeslot tag, then all his/her talks should not be assigned to a timeslot with that tag.
 - Talk preferred timeslot tag: If a talk has a preferred timeslot tag, then it should be assigned to a timeslot with that tag.
 - Talk undesired timeslot tag: If a talk has an undesired timeslot tag, then it should not be assigned to a timeslot with that tag.
 - Speaker preferred room tag: If a speaker has a preferred room tag, then all his/her talks should be assigned to a room with that tag.
 - Speaker undesired room tag: If a speaker has an undesired room tag, then all his/her talks should not be assigned to a room with that tag.
 - Talk preferred room tag: If a talk has a preferred room tag, then it should be assigned to a room with that tag.
 - Talk undesired room tag: If a talk has an undesired room tag, then it should not be assigned to a room with that tag.
- Same day talks: All talks that share a same theme tag or content tag should be scheduled in the minimum number of days (ideally in the same day).

Figure 31.14. Value proposition

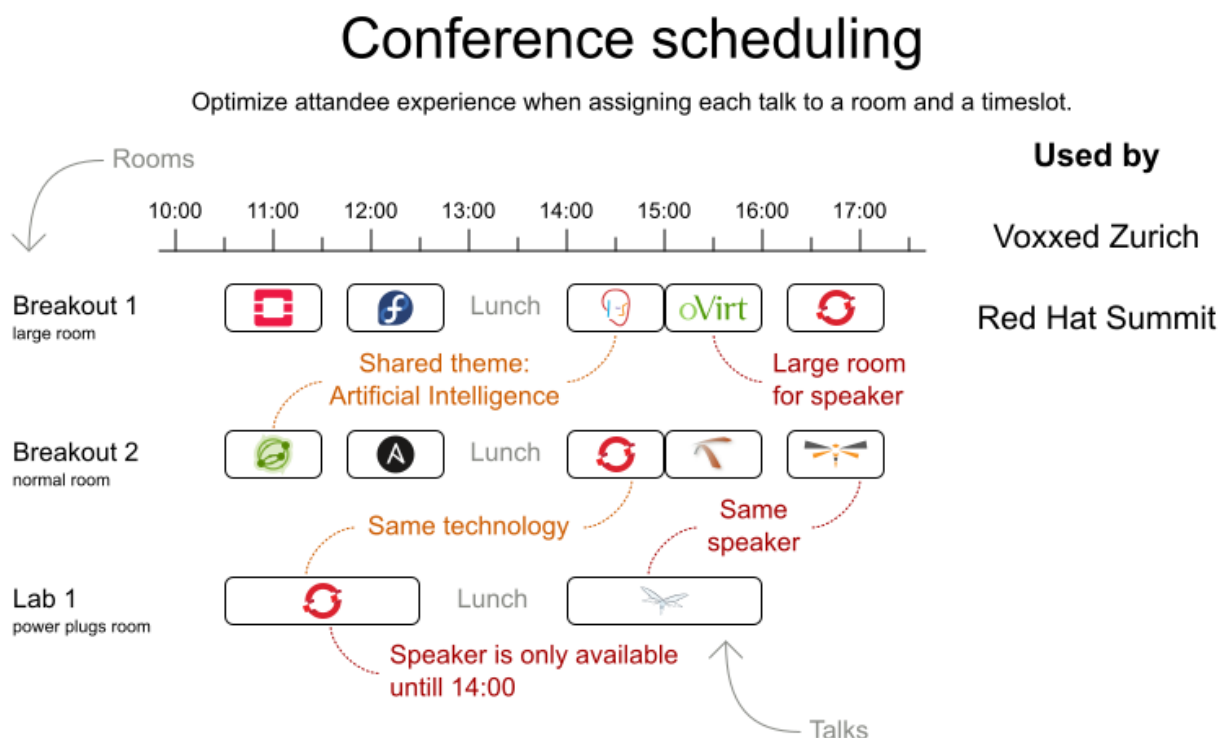

Problem size

18talks-6timeslots-5rooms has 18 talks, 6 timeslots and 5 rooms with a search space of 10^{26} .
 36talks-12timeslots-5rooms has 36 talks, 12 timeslots and 5 rooms with a search space of 10^{64} .
 72talks-12timeslots-10rooms has 72 talks, 12 timeslots and 10 rooms with a search space of 10^{149} .
 108talks-18timeslots-10rooms has 108 talks, 18 timeslots and 10 rooms with a search space of 10^{243} .
 216talks-18timeslots-20rooms has 216 talks, 18 timeslots and 20 rooms with a search space of 10^{552} .

31.17. ROCK TOUR

Drive the rock bus from show to show, but schedule shows only on available days.

Hard constraints:

- Schedule every required show.
- Schedule as many shows as possible.

Medium constraints:

- Maximize revenue opportunity.

- Minimize driving time.
- Visit sooner than later.

Soft constraints:

- Avoid long driving times.

Problem size

47shows has 47 shows with a search space of 10^{59} .

31.18. FLIGHT CREW SCHEDULING

Assign flights to pilots and flight attendants.

Hard constraints:

- Required skill: each flight assignment has a required skill. For example, flight AB0001 requires 2 pilots and 3 flight attendants.
- Flight conflict: each employee can only attend one flight at the same time
- Transfer between two flights: between two flights, an employee must be able to transfer from the arrival airport to the departure airport. For example, Ann arrives in Brussels at 10:00 and departs in Amsterdam at 15:00.
- Employee unavailability: the employee must be available on the day of the flight. For example, Ann is on PTO on 1-Feb.

Soft constraints:

- First assignment departing from home
- Last assignment arriving at home
- Load balance flight duration total per employee

Problem size

175flights-7days-Europe has 2 skills, 50 airports, 150 employees, 175 flights and 875 flight assignments with a search space of 10^{1904} .

700flights-28days-Europe has 2 skills, 50 airports, 150 employees, 700 flights and 3500 flight assignments with a search space of 10^{7616} .

875flights-7days-Europe has 2 skills, 50 airports, 750 employees, 875 flights and 4375 flight assignments with a search space of 10^{12578} .

175flights-7days-US has 2 skills, 48 airports, 150 employees, 175 flights and 875 flight assignments with a search space of 10^{1904} .

CHAPTER 32. DOWNLOADING RED HAT BUILD OF OPTAPLANNER EXAMPLES

You can download the Red Hat build of OptaPlanner examples as a part of the Red Hat Process Automation Manager add-ons package available on the Red Hat Customer Portal.

Procedure

1. Navigate to the [Software Downloads](#) page in the Red Hat Customer Portal (login required), and select the product and version from the drop-down options:
 - Product: Process Automation Manager
 - Version: 7.11
2. Download **Red Hat Process Automation Manager 7.11 Add Ons**
3. Extract the **rhpm-7.11.0-add-ons.zip** file. The extracted **add-ons** folder contains the **rhpm-7.11.0-planner-engine.zip** file.
4. Extract the **rhpm-7.11.0-planner-engine.zip** file.

Result

The extracted **rhpm-7.11.0-planner-engine** directory contains example source code under the following subdirectories:

- **examples/sources/src/main/java/org/optaplanner/examples**
- **examples/sources/src/main/resources/org/optaplanner/examples**

32.1. RUNNING OPTAPLANNER EXAMPLES

Red Hat build of OptaPlanner includes several examples that demonstrate a variety of planning use cases. Download and use the examples to explore different types of planning solutions.

Prerequisites

- You have downloaded and extracted the examples as described in [Chapter 32, Downloading Red Hat build of OptaPlanner examples](#).

Procedure

1. To run the examples, in the **rhpm-7.11.0-planner-engine/examples** directory enter one of the following commands:

Linux or Mac:

```
└─ $ ./runExamples.sh
```

Windows:

```
└─ $ runExamples.bat
```

The OptaPlanner Examples window opens.

2. Select an example to run that example.



NOTE

Red Hat build of OptaPlanner has no GUI dependencies. It runs just as well on a server or a mobile JVM as it does on the desktop.

32.2. RUNNING THE RED HAT BUILD OF OPTAPLANNER EXAMPLES IN AN IDE (INTELLIJ, ECLIPSE, OR NETBEANS)

If you use an integrated development environment (IDE), such as IntelliJ, Eclipse, or Netbeans, you can run your downloaded OptaPlanner examples within your development environment.

Prerequisites

- You have downloaded and extracted the OptaPlanner examples as described in [Chapter 32, Downloading Red Hat build of OptaPlanner examples](#).

Procedure

1. Open the OptaPlanner examples as a new project:
 - a. For IntelliJ or Netbeans, open **examples/sources/pom.xml** as the new project. The Maven integration guides you through the rest of the installation. Skip the rest of the steps in this procedure.
 - b. For Eclipse, open a new project for the **/examples/binaries** directory, located under the **rhpm-7.11.0-planner-engine** directory.
2. Add all the JAR files that are in the **binaries** directory to the classpath, except for the **examples/binaries/optaplanner-examples-7.52.0.Final-redhat-00007.jar** file.
3. Add the Java source directory **src/main/java** and the Java resources directory **src/main/resources**, located under the **rhpm-7.11.0-planner-engine/examples/sources/** directory.
4. Create a run configuration:
 - Main class: **org.optaplanner.examples.app.OptaPlannerExamplesApp**
 - VM parameters (optional): **-Xmx512M -server -Dorg.optaplanner.examples.dataDir=examples/sources/data**
 - Working directory: **examples/sources**
5. Run the run configuration.

CHAPTER 33. GETTING STARTED WITH OPTAPLANNER IN BUSINESS CENTRAL: AN EMPLOYEE ROSTERING EXAMPLE

You can build and deploy the **employee-rostering** sample project in Business Central. The project demonstrates how to create each of the Business Central assets required to solve the shift rostering planning problem and use Red Hat build of OptaPlanner to find the best possible solution.

You can deploy the preconfigured **employee-rostering** project in Business Central. Alternatively, you can create the project yourself using Business Central.



NOTE

The **employee-rostering** sample project in Business Central does not include a data set. You must supply a data set in XML format using a REST API call.

33.1. DEPLOYING THE EMPLOYEE ROSTERING SAMPLE PROJECT IN BUSINESS CENTRAL

Business Central includes a number of sample projects that you can use to get familiar with the product and its features. The employee rostering sample project is designed and created to demonstrate the shift rostering use case for Red Hat build of OptaPlanner. Use the following procedure to deploy and run the employee rostering sample in Business Central.

Prerequisites

- Red Hat Process Automation Manager has been downloaded and installed. For installation options, see [Planning a Red Hat Process Automation Manager installation](#) .
- You have started Red Hat Process Automation Manager, as described in the installation documentation, and you are logged in to Business Central as a user with **admin** permissions.

Procedure

1. In Business Central, click **Menu** → **Design** → **Projects**.
2. In the preconfigured **MySpace** space, click **Try Samples**.
3. Select **employee-rostering** from the list of sample projects and click **Ok** in the upper-right corner to import the project.
4. After the asset list has compiled, click **Build & Deploy** to deploy the employee rostering example.

The rest of this document explains each of the project assets and their configuration.

33.2. RE-CREATING THE EMPLOYEE ROSTERING SAMPLE PROJECT

The employee rostering sample project is a preconfigured project available in Business Central. You can learn about how to deploy this project in [Section 33.1, "Deploying the employee rostering sample project in Business Central"](#).

You can create the employee rostering example "from scratch". You can use the workflow in this example to create a similar project of your own in Business Central.

33.2.1. Setting up the employee rostering project

To start developing a solver in Business Central, you must set up the project.

Prerequisites

- Red Hat Process Automation Manager has been downloaded and installed.
- You have deployed Business Central and logged in with a user that has the **admin** role.

Procedure

1. Create a new project in Business Central by clicking **Menu → Design → Projects → Add Project**.
2. In the **Add Project** window, fill out the following fields:
 - **Name:** **employee-rostering**
 - **Description** (optional): Employee rostering problem optimization using OptaPlanner. Assigns employees to shifts based on their skill.

Optionally, click **Configure Advanced Options** to populate the **Group ID**, **Artifact ID**, and **Version** information.

- **Group ID:** **employeerostering**
 - **Artifact ID:** **employeerostering**
 - **Version:** **1.0.0-SNAPSHOT**
3. Click **Add** to add the project to the Business Central project repository.

33.2.2. Problem facts and planning entities

Each of the domain classes in the employee rostering planning problem is categorized as one of the following:

- An *unrelated class*: not used by any of the score constraints. From a planning standpoint, this data is obsolete.
- A *problem fact* class: used by the score constraints, but does not change during planning (as long as the problem stays the same), for example, **Shift** and **Employee**. All the properties of a problem fact class are problem properties.
- A *planning entity* class: used by the score constraints and changes during planning, for example, **ShiftAssignment**. The properties that change during planning are *planning variables*. The other properties are problem properties.
Ask yourself the following questions:
 - *What class changes during planning?*
 - *Which class has variables that I want the **Solver** to change?*
That class is a planning entity.

A planning entity class needs to be annotated with the **@PlanningEntity** annotation, or defined in Business Central using the Red Hat build of OptaPlanner dock in the domain designer.

Each planning entity class has one or more *planning variables*, and must also have one or more defining properties.

Most use cases have only one planning entity class, and only one planning variable per planning entity class.

33.2.3. Creating the data model for the employee rostering project

Use this section to create the data objects required to run the employee rostering sample project in Business Central.

Prerequisites

- You have completed the project setup described in [Section 33.2.1, "Setting up the employee rostering project"](#).

Procedure

- With your new project, either click **Data Object** in the project perspective, or click **Add Asset** → **Data Object** to create a new data object.
- Name the first data object **Timeslot**, and select **employeerostering.employeerostering** as the **Package**.
Click **Ok**.
- In the **Data Objects** perspective, click **+add field** to add fields to the **Timeslot** data object.
- In the **id** field, type **endTime**.
- Click the drop-down menu next to **Type** and select **LocalDateTime**.
- Click **Create and continue** to add another field.
- Add another field with the **id** **startTime** and **Type** **LocalDateTime**.
- Click **Create**.
- Click **Save** in the upper-right corner to save the **Timeslot** data object.
- Click the **x** in the upper-right corner to close the **Data Objects** perspective and return to the **Assets** menu.
- Using the previous steps, create the following data objects and their attributes:

Table 33.1. Skill

| id | Type |
|-------------|---------------|
| name | String |

Table 33.2. Employee

| id | Type |
|---------------|--|
| name | String |
| skills | employee rostering.employee rostering.Skill[List] |

Table 33.3. Shift

| id | Type |
|----------------------|---|
| requiredSkill | employee rostering.employee rostering.Skill |
| timeslot | employee rostering.employee rostering.Timeslot |

Table 33.4. DayOffRequest

| id | Type |
|-----------------|---|
| date | LocalDate |
| employee | employee rostering.employee rostering.Employee |

Table 33.5. ShiftAssignment

| id | Type |
|-----------------|---|
| employee | employee rostering.employee rostering.Employee |
| shift | employee rostering.employee rostering.Shift |

For more examples of creating data objects, see [Getting started with decision services](#).

33.2.3.1. Creating the employee roster planning entity

In order to solve the employee rostering planning problem, you must create a planning entity and a solver. The planning entity is defined in the domain designer using the attributes available in the Red Hat build of OptaPlanner dock.

Use the following procedure to define the **ShiftAssignment** data object as the planning entity for the employee rostering example.

Prerequisites

- You have created the relevant data objects and planning entity required to run the employee rostering example by completing the procedures in [Section 33.2.3, "Creating the data model for the employee rostering project"](#).

Procedure

- From the project **Assets** menu, open the **ShiftAssignment** data object.
- In the **Data Objects** perspective, open the OptaPlanner dock by clicking the  on the right.
- Select **Planning Entity**.
- Select **employee** from the list of fields under the **ShiftAssignment** data object.
- In the OptaPlanner dock, select **Planning Variable**.
In the **Value Range Id** input field, type **employeeRange**. This adds the **@ValueRangeProvider** annotation to the planning entity, which you can view by clicking the **Source** tab in the designer.

The value range of a planning variable is defined with the **@ValueRangeProvider** annotation. A **@ValueRangeProvider** annotation always has a property **id**, which is referenced by the **@PlanningVariable** property **valueRangeProviderRefs**.

- Close the dock and click **Save** to save the data object.

33.2.3.2. Creating the employee roster planning solution

The employee roster problem relies on a defined planning solution. The planning solution is defined in the domain designer using the attributes available in the Red Hat build of OptaPlanner dock.

Prerequisites

- You have created the relevant data objects and planning entity required to run the employee rostering example by completing the procedures in [Section 33.2.3, "Creating the data model for the employee rostering project"](#) and [Section 33.2.3.1, "Creating the employee roster planning entity"](#).

Procedure

- Create a new data object with the identifier **EmployeeRoster**.
- Create the following fields:

Table 33.6. EmployeeRoster

| id | Type |
|----------------------------|--|
| dayOffRequestList | employeerostering.employeerostering.DayOffRequest[List] |
| shiftAssignmentList | employeerostering.employeerostering.ShiftAssignment[List] |

| id | Type |
|---------------------|---|
| shiftList | employee rostering.employee rostering.Shift[List] |
| skillList | employee rostering.employee rostering.Skill[List] |
| timeslotList | employee rostering.employee rostering.Timeslot[List] |

- In the **Data Objects** perspective, open the OptaPlanner dock by clicking the  on the right.
- Select **Planning Solution**.
- Leave the default **Hard soft score** as the **Solution Score Type**. This automatically generates a **score** field in the **EmployeeRoster** data object with the solution score as the type.
- Add a new field with the following attributes:

| id | Type |
|---------------------|---|
| employeeList | employee rostering.employee rostering.Employee[List] |

- With the **employeeList** field selected, open the OptaPlanner dock and select the **Planning Value Range Provider** box.
In the **id** field, type **employeeRange**. Close the dock.
- Click **Save** in the upper-right corner to save the asset.

33.2.4. Employee rostering constraints

Employee rostering is a planning problem. All planning problems include constraints that must be satisfied in order to find an optimal solution.

The employee rostering sample project in Business Central includes the following hard and soft constraints:

Hard constraint

- Employees are only assigned one shift per day.
- All shifts that require a particular employee skill are assigned an employee with that particular skill.

Soft constraints

- All employees are assigned a shift.

- If an employee requests a day off, their shift is reassigned to another employee.

Hard and soft constraints are defined in Business Central using either the free-form DRL designer, or using guided rules.

33.2.4.1. DRL (Drools Rule Language) rules

DRL (Drools Rule Language) rules are business rules that you define directly in **.drl** text files. These DRL files are the source in which all other rule assets in Business Central are ultimately rendered. You can create and manage DRL files within the Business Central interface, or create them externally as part of a Maven or Java project using Red Hat CodeReady Studio or another integrated development environment (IDE). A DRL file can contain one or more rules that define at a minimum the rule conditions (**when**) and actions (**then**). The DRL designer in Business Central provides syntax highlighting for Java, DRL, and XML.

DRL files consist of the following components:

Components in a DRL file

```

package

import

function // Optional

query // Optional

declare // Optional

global // Optional

rule "rule name"
  // Attributes
  when
    // Conditions
  then
    // Actions
end

rule "rule2 name"

...

```

The following example DRL rule determines the age limit in a loan application decision service:

Example rule for loan application age limit

```

rule "Underage"
  salience 15
  agenda-group "applicationGroup"
  when
    $application : LoanApplication()
    Applicant( age < 21 )
  then

```

```

$application.setApproved( false );
$application.setExplanation( "Underage" );
end

```

A DRL file can contain single or multiple rules, queries, and functions, and can define resource declarations such as imports, globals, and attributes that are assigned and used by your rules and queries. The DRL package must be listed at the top of a DRL file and the rules are typically listed last. All other DRL components can follow any order.

Each rule must have a unique name within the rule package. If you use the same rule name more than once in any DRL file in the package, the rules fail to compile. Always enclose rule names with double quotation marks (**rule "rule name"**) to prevent possible compilation errors, especially if you use spaces in rule names.

All data objects related to a DRL rule must be in the same project package as the DRL file in Business Central. Assets in the same package are imported by default. Existing assets in other packages can be imported with the DRL rule.

33.2.4.2. Defining constraints for employee rostering using the DRL designer

You can create constraint definitions for the employee rostering example using the free-form DRL designer in Business Central.

Use this procedure to create a *hard constraint* where no employee is assigned a shift that begins less than 10 hours after their previous shift ended.

Procedure

1. In Business Central, go to **Menu → Design → Projects** and click the project name.
2. Click **Add Asset → DRL file**.
3. In the **DRL file** name field, type **ComplexScoreRules**.
4. Select the **employeerostering.employeerostering** package.
5. Click **+Ok** to create the DRL file.
6. In the **Model** tab of the DRL designer, define the **Employee10HourShiftSpace** rule as a DRL file:

```

package employeerostering.employeerostering;

rule "Employee10HourShiftSpace"
  when
    $shiftAssignment : ShiftAssignment( $employee : employee != null, $shiftEndDateTime :
shift.timeslot.endTime)
    ShiftAssignment( this != $shiftAssignment, $employee == employee, $shiftEndDateTime
<= shift.timeslot.endTime,
    $shiftEndDateTime.until(shift.timeslot.startTime,
java.time.temporal.ChronoUnit.HOURS) <10)
  then
    scoreHolder.addHardConstraintMatch(kcontext, -1);
end

```

7. Click **Save** to save the DRL file.

For more information about creating DRL files, see [Designing a decision service using DRL rules](#).

33.2.5. Creating rules for employee rostering using guided rules

You can create rules that define hard and soft constraints for employee rostering using the guided rules designer in Business Central.

33.2.5.1. Guided rules

Guided rules are business rules that you create in a UI-based guided rules designer in Business Central that leads you through the rule-creation process. The guided rules designer provides fields and options for acceptable input based on the data objects for the rule being defined. The guided rules that you define are compiled into Drools Rule Language (DRL) rules as with all other rule assets.



All data objects related to a guided rule must be in the same project package as the guided rule. Assets in the same package are imported by default. After you create the necessary data objects and the guided rule, you can use the **Data Objects** tab of the guided rules designer to verify that all required data objects are listed or to import other existing data objects by adding a **New item**.

33.2.5.2. Creating a guided rule to balance employee shift numbers

The **BalanceEmployeesShiftNumber** guided rule creates a soft constraint that ensures shifts are assigned to employees in a way that is balanced as evenly as possible. It does this by creating a score penalty that increases when shift distribution is less even. The score formula, implemented by the rule, incentivizes the Solver to distribute shifts in a more balanced way.

Procedure

1. In Business Central, go to **Menu** → **Design** → **Projects** and click the project name.
2. Click **Add Asset** → **Guided Rule**.
3. Enter **BalanceEmployeesShiftNumber** as the **Guided Rule** name and select the **employeerostering.employeerostering** Package.
4. Click **Ok** to create the rule asset.
5. Add a **WHEN** condition by clicking the **+** in the **WHEN** field.
6. Select **Employee** in the **Add a condition to the rulewindow**. Click **+Ok**.
7. Click the **Employee** condition to modify the constraints and add the variable name **\$employee**.

8. Add the **WHEN** condition **From Accumulate**.
 - a. Above the **From Accumulate** condition, click **click to add pattern** and select **Number** as the fact type from the drop-down list.
 - b. Add the variable name **\$shiftCount** to the **Number** condition.
 - c. Below the **From Accumulate** condition, click **click to add pattern** and select the **ShiftAssignment** fact type from the drop-down list.
 - d. Add the variable name **\$shiftAssignment** to the **ShiftAssignment** fact type.
 - e. Click the **ShiftAssignment** condition again and from the **Add a restriction on a field** drop-down list, select **employee**.
 - f. Select **equal to** from the drop-down list next to the **employee** constraint.
 - g. Click the  icon next to the drop-down button to add a variable, and click **Bound variable** in the **Field value** window.
 - h. Select **\$employee** from the drop-down list.
 - i. In the **Function** box type **count(\$shiftAssignment)**.
9. Add the **THEN** condition by clicking the  in the **THEN** field.
10. Select **Modify Soft Score** in the **Add a new action** window. Click **+Ok**.
 - a. Type the following expression into the box: -
(\$shiftCount.intValue()*\$shiftCount.intValue())
11. Click **Validate** in the upper-right corner to check all rule conditions are valid. If the rule validation fails, address any problems described in the error message, review all components in the rule, and try again to validate the rule until the rule passes.
12. Click **Save** to save the rule.

For more information about creating guided rules, see [Designing a decision service using guided rules](#) .

33.2.5.3. Creating a guided rule for no more than one shift per day

The **OneEmployeeShiftPerDay** guided rule creates a hard constraint that employees are not assigned more than one shift per day. In the employee rostering example, this constraint is created using the guided rule designer.

OneEmployeeShiftPerDay.rdr - Guided Rules

Save Delete Rename Copy Validate Latest Version

Editor Overview Source Data Objects

EXTENDS - None -

WHEN

1. \$shiftAssignment : ShiftAssignment(employee != null)
ShiftAssignment(this != \$shiftAssignment , employee == \$shiftAssignment.employee , shift.timeslot.startTime.toLocalDate() == \$shiftAssignment.shift.timeslot.startTime.toLocalDate())

THEN

1. scoreHolder.addHardConstraintMatch(kcontext, -1);

(show options...)

Messages Clear

Procedure

1. In Business Central, go to **Menu** → **Design** → **Projects** and click the project name.
2. Click **Add Asset** → **Guided Rule**.
3. Enter **OneEmployeeShiftPerDay** as the **Guided Rule** name and select the **employee rostering.employee rostering** Package.
4. Click **Ok** to create the rule asset.
5. Add a **WHEN** condition by clicking the **+** in the **WHEN** field.
6. Select **Free form DRL** from the **Add a condition to the rule window**.
7. In the free form DRL box, type the following condition:

```
$shiftAssignment : ShiftAssignment( employee != null )
  ShiftAssignment( this != $shiftAssignment , employee == $shiftAssignment.employee ,
  shift.timeslot.startTime.toLocalDate() ==
  $shiftAssignment.shift.timeslot.startTime.toLocalDate() )
```

This condition states that a shift cannot be assigned to an employee that already has another shift assignment on the same day.

8. Add the **THEN** condition by clicking the **+** in the **THEN** field.
 9. Select **Add free form DRL** from the **Add a new action window**.
 10. In the free form DRL box, type the following condition:
- ```
scoreHolder.addHardConstraintMatch(kcontext, -1);
```
11. Click **Validate** in the upper-right corner to check all rule conditions are valid. If the rule validation fails, address any problems described in the error message, review all components in the rule, and try again to validate the rule until the rule passes.
  12. Click **Save** to save the rule.

For more information about creating guided rules, see [Designing a decision service using guided rules](#).

### 33.2.5.4. Creating a guided rule to match skills to shift requirements

The **ShiftRequiredSkillsAreMet** guided rule creates a hard constraint that ensures all shifts are assigned an employee with the correct set of skills. In the employee rostering example, this constraint is created using the guided rule designer.

## Procedure

1. In Business Central, go to **Menu** → **Design** → **Projects** and click the project name.
2. Click **Add Asset** → **Guided Rule**.
3. Enter **ShiftRequiredSkillsAreMet** as the **Guided Rule** name and select the **employee rostering.employee rostering** Package.
4. Click **Ok** to create the rule asset.
5. Add a **WHEN** condition by clicking the **+** in the **WHEN** field.
6. Select **ShiftAssignment** in the **Add a condition to the rule window**. Click **+Ok**.
7. Click the **ShiftAssignment** condition, and select **employee** from the **Add a restriction on a field** drop-down list.
8. In the designer, click the drop-down list next to **employee** and select **is not null**.
9. Click the **ShiftAssignment** condition, and click **Expression editor**.
  - a. In the designer, click **[not bound]** to open the **Expression editor**, and bind the expression to the variable **\$requiredSkill**. Click **Set**.
  - b. In the designer, next to **\$requiredSkill**, select **shift** from the first drop-down list, then **requiredSkill** from the next drop-down list.
10. Click the **ShiftAssignment** condition, and click **Expression editor**.
  - a. In the designer, next to **[not bound]**, select **employee** from the first drop-down list, then **skills** from the next drop-down list.
  - b. Leave the next drop-down list as **Choose**.
  - c. In the next drop-down box, change **please choose** to **excludes**.
  - d. Click the  icon next to **excludes**, and in the **Field value** window, click the **New formula** button.

- e. Type **\$requiredSkill** into the formula box.
11. Add the **THEN** condition by clicking the **+** in the **THEN** field.
12. Select **Modify Hard Score** in the **Add a new action** window. Click **+Ok**.
13. Type **-1** into the score actions box.
14. Click **Validate** in the upper-right corner to check all rule conditions are valid. If the rule validation fails, address any problems described in the error message, review all components in the rule, and try again to validate the rule until the rule passes.
15. Click **Save** to save the rule.

For more information about creating guided rules, see [Designing a decision service using guided rules](#).

### 33.2.5.5. Creating a guided rule to manage day off requests

The **DayOffRequest** guided rule creates a soft constraint. This constraint allows a shift to be reassigned to another employee in the event the employee who was originally assigned the shift is no longer able to work that day. In the employee rostering example, this constraint is created using the guided rule designer.

#### Procedure

1. In Business Central, go to **Menu → Design → Projects** and click the project name.
2. Click **Add Asset → Guided Rule**.
3. Enter **DayOffRequest** as the **Guided Rule** name and select the **employee rostering.employee rostering Package**.
4. Click **Ok** to create the rule asset.
5. Add a **WHEN** condition by clicking the **+** in the **WHEN** field.
6. Select **Free form DRL** from the **Add a condition to the rule** window.
7. In the free form DRL box, type the following condition:

```
$dayOffRequest : DayOffRequest()
 ShiftAssignment(employee == $dayOffRequest.employee ,
 shift.timeslot.startTime.toLocalDate() == $dayOffRequest.date)
```

This condition states if a shift is assigned to an employee who has made a day off request, the employee can be unassigned the shift on that day.

8. Add the **THEN** condition by clicking the  in the **THEN** field.
9. Select **Add free form DRL** from the **Add a new action** window.
10. In the free form DRL box, type the following condition:

```
scoreHolder.addSoftConstraintMatch(kcontext, -100);
```

11. Click **Validate** in the upper-right corner to check all rule conditions are valid. If the rule validation fails, address any problems described in the error message, review all components in the rule, and try again to validate the rule until the rule passes.
12. Click **Save** to save the rule.

For more information about creating guided rules, see [Designing a decision service using guided rules](#) .

### 33.2.6. Creating a solver configuration for employee rostering

You can create and edit Solver configurations in Business Central. The Solver configuration designer creates a solver configuration that can be run after the project is deployed.

#### Prerequisites

- Red Hat Process Automation Manager has been downloaded and installed.
- You have created and configured all of the relevant assets for the employee rostering example.

#### Procedure

1. In Business Central, click **Menu** → **Projects**, and click your project to open it.
2. In the **Assets** perspective, click **Add Asset** → **Solver configuration**
3. In the **Create new Solver configuration** window, type the name **EmployeeRosteringSolverConfig** for your Solver and click **Ok**. This opens the **Solver configuration** designer.
4. In the **Score Director Factory** configuration section, define a KIE base that contains scoring rule definitions. The employee rostering sample project uses **defaultKieBase**.
  - a. Select one of the KIE sessions defined within the KIE base. The employee rostering sample project uses **defaultKieSession**.
5. Click **Validate** in the upper-right corner to check the **Score Director Factory** configuration is correct. If validation fails, address any problems described in the error message, and try again to validate until the configuration passes.
6. Click **Save** to save the Solver configuration.

### 33.2.7. Configuring Solver termination for the employee rostering project



You can configure the Solver to terminate after a specified amount of time. By default, the planning engine is given an unlimited time period to solve a problem instance.

The employee rostering sample project is set up to run for 30 seconds.

### Prerequisites

- You have created all relevant assets for the employee rostering project and created the **EmployeeRosteringSolverConfig** solver configuration in Business Central as described in [Section 33.2.6, "Creating a solver configuration for employee rostering"](#).

### Procedure

1. Open the **EmployeeRosteringSolverConfig** from the **Assets** perspective. This will open the **Solver configuration** designer.
2. In the **Termination** section, click **Add** to create new termination element within the selected logical group.
3. Select the **Time spent** termination type from the drop-down list. This is added as an input field in the termination configuration.
4. Use the arrows next to the time elements to adjust the amount of time spent to 30 seconds.
5. Click **Validate** in the upper-right corner to check the **Score Director Factory** configuration is correct. If validation fails, address any problems described in the error message, and try again to validate until the configuration passes.
6. Click **Save** to save the Solver configuration.

## 33.3. ACCESSING THE SOLVER USING THE REST API

After deploying or re-creating the sample solver, you can access it using the REST API.

You must register a solver instance using the REST API. Then you can supply data sets and retrieve optimized solutions.

### Prerequisites

- The employee rostering project is set up and deployed according to the previous sections in this document. You can either deploy the sample project, as described in [Section 33.1, "Deploying the employee rostering sample project in Business Central"](#), or re-create the project, as described in [Section 33.2, "Re-creating the employee rostering sample project"](#).

### 33.3.1. Registering the Solver using the REST API

You must register the solver instance using the REST API before you can use the solver.

Each solver instance is capable of optimizing one planning problem at a time.

### Procedure

1. Create a HTTP request using the following header:

```
authorization: admin:admin
X-KIE-ContentType: xstream
content-type: application/xml
```

2. Register the Solver using the following request:

**PUT**

**http://localhost:8080/kie-server/services/rest/server/containers/employeerostering\_1.0.0-SNAPSHOT/solvers/EmployeeRosteringSolver**

Request body

```
<solver-instance>
 <solver-config-
file>employeerostering/employeerostering/EmployeeRosteringSolverConfig.solver.xml</s
olver-config-file>
</solver-instance>
```

### 33.3.2. Calling the Solver using the REST API

After registering the solver instance, you can use the REST API to submit a data set to the solver and to retrieve an optimized solution.

#### Procedure

1. Create a HTTP request using the following header:

```
authorization: admin:admin
X-KIE-ContentType: xstream
content-type: application/xml
```

2. Submit a request to the Solver with a data set, as in the following example:

**POST**

**http://localhost:8080/kie-server/services/rest/server/containers/employeerostering\_1.0.0-SNAPSHOT/solvers/EmployeeRosteringSolver/state/solving**

Request body

```
<employeerostering.employeerostering.EmployeeRoster>
 <employeeList>
 <employeerostering.employeerostering.Employee>
 <name>John</name>
 <skills>
 <employeerostering.employeerostering.Skill>
 <name>reading</name>
 </employeerostering.employeerostering.Skill>
 </skills>
 </employeerostering.employeerostering.Employee>
 <employeerostering.employeerostering.Employee>
 <name>Mary</name>
 <skills>
```

```

 <employee rostering.employee rostering.Skill>
 <name>writing</name>
 </employee rostering.employee rostering.Skill>
 </skills>
</employee rostering.employee rostering.Employee>
<employee rostering.employee rostering.Employee>
 <name>Petr</name>
 <skills>
 <employee rostering.employee rostering.Skill>
 <name>speaking</name>
 </employee rostering.employee rostering.Skill>
 </skills>
</employee rostering.employee rostering.Employee>
</employeeList>
<shiftList>
 <employee rostering.employee rostering.Shift>
 <timeslot>
 <startTime>2017-01-01T00:00:00</startTime>
 <endTime>2017-01-01T01:00:00</endTime>
 </timeslot>
 <requiredSkill
reference="../../../../employeeList/employee rostering.employee rostering.Employee/skills/employee rostering.employee rostering.Skill"/>
 </employee rostering.employee rostering.Shift>
 <employee rostering.employee rostering.Shift>
 <timeslot
reference="../../../../employee rostering.employee rostering.Shift/timeslot"/>
 <requiredSkill
reference="../../../../employeeList/employee rostering.employee rostering.Employee[3]/skills/employee rostering.employee rostering.Skill"/>
 </employee rostering.employee rostering.Shift>
 <employee rostering.employee rostering.Shift>
 <timeslot
reference="../../../../employee rostering.employee rostering.Shift/timeslot"/>
 <requiredSkill
reference="../../../../employeeList/employee rostering.employee rostering.Employee[2]/skills/employee rostering.employee rostering.Skill"/>
 </employee rostering.employee rostering.Shift>
</shiftList>
<skillList>
 <employee rostering.employee rostering.Skill
reference="../../../../employeeList/employee rostering.employee rostering.Employee/skills/employee rostering.employee rostering.Skill"/>
 <employee rostering.employee rostering.Skill
reference="../../../../employeeList/employee rostering.employee rostering.Employee[3]/skills/employee rostering.employee rostering.Skill"/>
 <employee rostering.employee rostering.Skill
reference="../../../../employeeList/employee rostering.employee rostering.Employee[2]/skills/employee rostering.employee rostering.Skill"/>
</skillList>
<timeslotList>
 <employee rostering.employee rostering.Timeslot
reference="../../../../shiftList/employee rostering.employee rostering.Shift/timeslot"/>
</timeslotList>
<dayOffRequestList/>
<shiftAssignmentList>
 <employee rostering.employee rostering.ShiftAssignment>
 <shift
reference="../../../../shiftList/employee rostering.employee rostering.Shift"/>

```

```

</employee rostering.employee rostering.ShiftAssignment>
<employee rostering.employee rostering.ShiftAssignment>
 <shift reference="../../shiftList/employee rostering.employee rostering.Shift[3]"/>
</employee rostering.employee rostering.ShiftAssignment>
<employee rostering.employee rostering.ShiftAssignment>
 <shift reference="../../shiftList/employee rostering.employee rostering.Shift[2]"/>
</employee rostering.employee rostering.ShiftAssignment>
</shiftAssignmentList>
</employee rostering.employee rostering.EmployeeRoster>

```

3. Request the best solution to the planning problem:

GET

**http://localhost:8080/kie-server/services/rest/server/containers/employee rostering\_1.0.0-SNAPSHOT/solvers/EmployeeRosteringSolver/bestsolution**

Example response

```

<solver-instance>
 <container-id>employee-rostering</container-id>
 <solver-id>solver1</solver-id>
 <solver-config-
file>employee rostering/employee rostering/EmployeeRosteringSolverConfig.solver.xml</s
olver-config-file>
 <status>NOT_SOLVING</status>
 <score
scoreClass="org.optaplanner.core.api.score.buildin.hardsoft.HardSoftScore">0hard/0soft<
/score>
 <best-solution class="employee rostering.employee rostering.EmployeeRoster">
 <employeeList>
 <employee rostering.employee rostering.Employee>
 <name>John</name>
 <skills>
 <employee rostering.employee rostering.Skill>
 <name>reading</name>
 </employee rostering.employee rostering.Skill>
 </skills>
 </employee rostering.employee rostering.Employee>
 <employee rostering.employee rostering.Employee>
 <name>Mary</name>
 <skills>
 <employee rostering.employee rostering.Skill>
 <name>writing</name>
 </employee rostering.employee rostering.Skill>
 </skills>
 </employee rostering.employee rostering.Employee>
 <employee rostering.employee rostering.Employee>
 <name>Petr</name>
 <skills>
 <employee rostering.employee rostering.Skill>
 <name>speaking</name>
 </employee rostering.employee rostering.Skill>
 </skills>
 </employee rostering.employee rostering.Employee>
 </employeeList>
 </best-solution>
</solver-instance>

```

```

</employeeList>
<shiftList>
 <employee rostering.employee rostering.Shift>
 <timeslot>
 <startTime>2017-01-01T00:00:00</startTime>
 <endTime>2017-01-01T01:00:00</endTime>
 </timeslot>
 <requiredSkill
reference="../../../../employeeList/employee rostering.employee rostering.Employee/skills/emp
lo rostering.employee rostering.Skill"/>
 </employee rostering.employee rostering.Shift>
 <employee rostering.employee rostering.Shift>
 <timeslot reference="../../../../employee rostering.employee rostering.Shift/timeslot"/>
 <requiredSkill
reference="../../../../employeeList/employee rostering.employee rostering.Employee[3]/skills/emp
lo rostering.employee rostering.Skill"/>
 </employee rostering.employee rostering.Shift>
 <employee rostering.employee rostering.Shift>
 <timeslot reference="../../../../employee rostering.employee rostering.Shift/timeslot"/>
 <requiredSkill
reference="../../../../employeeList/employee rostering.employee rostering.Employee[2]/skills/emp
lo rostering.employee rostering.Skill"/>
 </employee rostering.employee rostering.Shift>
</shiftList>
<skillList>
 <employee rostering.employee rostering.Skill
reference="../../../../employeeList/employee rostering.employee rostering.Employee/skills/emp
lo rostering.employee rostering.Skill"/>
 <employee rostering.employee rostering.Skill
reference="../../../../employeeList/employee rostering.employee rostering.Employee[3]/skills/emp
lo rostering.employee rostering.Skill"/>
 <employee rostering.employee rostering.Skill
reference="../../../../employeeList/employee rostering.employee rostering.Employee[2]/skills/emp
lo rostering.employee rostering.Skill"/>
</skillList>
<timeslotList>
 <employee rostering.employee rostering.Timeslot
reference="../../../../shiftList/employee rostering.employee rostering.Shift/timeslot"/>
</timeslotList>
<dayOffRequestList/>
<shiftAssignmentList/>
<score>0hard/0soft</score>
</best-solution>
</solver-instance>

```

## CHAPTER 34. GETTING STARTED WITH OPTAPLANNER AND QUARKUS

You can use the <https://code.quarkus.redhat.com> website to generate a Red Hat build of OptaPlanner Quarkus Maven project and automatically add and configure the extensions that you want to use in your application. You can then download the Quarkus Maven repository or use the online Maven repository with your project.

### 34.1. APACHE MAVEN AND RED HAT BUILD OF QUARKUS

Apache Maven is a distributed build automation tool used in Java application development to create, manage, and build software projects. Maven uses standard configuration files called Project Object Model (POM) files to define projects and manage the build process. POM files describe the module and component dependencies, build order, and targets for the resulting project packaging and output using an XML file. This ensures that the project is built in a correct and uniform manner.

#### Maven repositories

A Maven repository stores Java libraries, plug-ins, and other build artifacts. The default public repository is the Maven 2 Central Repository, but repositories can be private and internal within a company to share common artifacts among development teams. Repositories are also available from third parties.

You can use the online Maven repository with your Quarkus projects or you can download the Red Hat build of Quarkus Maven repository.

#### Maven plug-ins

Maven plug-ins are defined parts of a POM file that achieve one or more goals. Quarkus applications use the following Maven plug-ins:

- Quarkus Maven plug-in (**quarkus-maven-plugin**): Enables Maven to create Quarkus projects, supports the generation of uber-JAR files, and provides a development mode.
- Maven Surefire plug-in (**maven-surefire-plugin**): Used during the test phase of the build lifecycle to execute unit tests on your application. The plug-in generates text and XML files that contain the test reports.

### 34.2. CONFIGURING THE MAVEN `SETTINGS.XML` FILE FOR THE ONLINE REPOSITORY

You can use the online Maven repository with your Maven project by configuring your user **settings.xml** file. This is the recommended approach. Maven settings used with a repository manager or repository on a shared server provide better control and manageability of projects.



#### NOTE

When you configure the repository by modifying the Maven **settings.xml** file, the changes apply to all of your Maven projects.

#### Procedure

1. Open the Maven `~/.m2/settings.xml` file in a text editor or integrated development environment (IDE).

**NOTE**

If there is not a **settings.xml** file in the `~/.m2/` directory, copy the **settings.xml** file from the `$MAVEN_HOME/.m2/conf/` directory into the `~/.m2/` directory.

2. Add the following lines to the `<profiles>` element of the **settings.xml** file:

```
<!-- Configure the Maven repository -->
<profile>
 <id>red-hat-enterprise-maven-repository</id>
 <repositories>
 <repository>
 <id>red-hat-enterprise-maven-repository</id>
 <url>https://maven.repository.redhat.com/ga/</url>
 <releases>
 <enabled>true</enabled>
 </releases>
 <snapshots>
 <enabled>>false</enabled>
 </snapshots>
 </repository>
 </repositories>
 <pluginRepositories>
 <pluginRepository>
 <id>red-hat-enterprise-maven-repository</id>
 <url>https://maven.repository.redhat.com/ga/</url>
 <releases>
 <enabled>true</enabled>
 </releases>
 <snapshots>
 <enabled>>false</enabled>
 </snapshots>
 </pluginRepository>
 </pluginRepositories>
</profile>
```

3. Add the following lines to the `<activeProfiles>` element of the **settings.xml** file and save the file.

```
<activeProfile>red-hat-enterprise-maven-repository</activeProfile>
```

### 34.3. DOWNLOADING AND CONFIGURING THE QUARKUS MAVEN REPOSITORY

If you do not want to use the online Maven repository, you can download and configure the Quarkus Maven repository to create a Quarkus application with Maven. The Quarkus Maven repository contains many of the requirements that Java developers typically use to build their applications. This procedure describes how to edit the **settings.xml** file to configure the Quarkus Maven repository.

**NOTE**

When you configure the repository by modifying the Maven **settings.xml** file, the changes apply to all of your Maven projects.

## Procedure

1. Download the Red Hat build of Quarkus Maven repository ZIP file from the [Software Downloads](#) page of the Red Hat Customer Portal (login required).
2. Expand the downloaded archive.
3. Change directory to the `~/.m2/` directory and open the Maven **settings.xml** file in a text editor or integrated development environment (IDE).
4. Add the following lines to the `<profiles>` element of the **settings.xml** file, where **QUARKUS\_MAVEN\_REPOSITORY** is the path of the Quarkus Maven repository that you downloaded. The format of **QUARKUS\_MAVEN\_REPOSITORY** must be **file://\$PATH**, for example **file:///home/userX/rh-quarkus-1.11.6.GA-maven-repository/maven-repository**.

```

<!-- Configure the Quarkus Maven repository -->
<profile>
 <id>red-hat-enterprise-maven-repository</id>
 <repositories>
 <repository>
 <id>red-hat-enterprise-maven-repository</id>
 <url>QUARKUS_MAVEN_REPOSITORY</url>
 <releases>
 <enabled>true</enabled>
 </releases>
 <snapshots>
 <enabled>false</enabled>
 </snapshots>
 </repository>
 </repositories>
 <pluginRepositories>
 <pluginRepository>
 <id>red-hat-enterprise-maven-repository</id>
 <url>QUARKUS_MAVEN_REPOSITORY</url>
 <releases>
 <enabled>true</enabled>
 </releases>
 <snapshots>
 <enabled>false</enabled>
 </snapshots>
 </pluginRepository>
 </pluginRepositories>
</profile>

```

5. Add the following lines to the `<activeProfiles>` element of the **settings.xml** file and save the file.

```

<activeProfile>red-hat-enterprise-maven-repository</activeProfile>

```





## IMPORTANT

If your Maven repository contains outdated artifacts, you might encounter one of the following Maven error messages when you build or deploy your project, where ***ARTIFACT\_NAME*** is the name of a missing artifact and ***PROJECT\_NAME*** is the name of the project you are trying to build:

- **Missing artifact *PROJECT\_NAME***
- **[ERROR] Failed to execute goal on project *ARTIFACT\_NAME*; Could not resolve dependencies for *PROJECT\_NAME***

To resolve the issue, delete the cached version of your local repository located in the `~/.m2/repository` directory to force a download of the latest Maven artifacts.

## 34.4. CREATING A RED HAT BUILD OF QUARKUS MAVEN PROJECT USING CODE.QUARKUS.REDHAT.COM

You can use the **code.quarkus.redhat.com** website to generate a Red Hat build of OptaPlanner Quarkus Maven project and automatically add and configure the extensions that you want to use in your application. In addition, **code.quarkus.redhat.com** automatically manages the configuration parameters required to compile your project into a native executable.

This section walks you through the process of generating an OptaPlanner Maven project and includes the following topics:

- Specifying basic details about your application.
- Choosing the extensions that you want to include in your project.
- Generating a downloadable archive with your project files.
- Using the custom commands for compiling and starting your application.

### Prerequisites

- You have a web browser.

### Procedure

1. Open <https://code.quarkus.redhat.com> in your web browser:
2. Specify details about your project:
3. Enter a group name for your project. The format of the name follows the Java package naming convention, for example, **com.example**.
4. Enter a name that you want to use for Maven artifacts generated from your project, for example **code-with-quarkus**.
5. Select **Build Tool > Maven** to specify that you want to create a Maven project. The build tool that you choose determines the items:
  - The directory structure of your generated project
  - The format of configuration files used in your generated project

- The custom build script and command for compiling and starting your application that **code.quarkus.redhat.com** displays for you after you generate your project



#### NOTE

Red Hat provides support for using **code.quarkus.redhat.com** to create OptaPlanner Maven projects only. Generating Gradle projects is not supported by Red Hat.

6. Enter a version to be used in artifacts generated from your project. The default value of this field is **1.0.0-SNAPSHOT**. Using [semantic versioning](#) is recommended, but you can use a different type of versioning if you prefer.
7. Enter the package name of artifacts that the build tool generates when you package your project.  
According to the Java package naming conventions the package name should match the group name that you use for your project, but you can specify a different name.



#### NOTE

The **code.quarkus.redhat.com** website automatically uses the latest release of OptaPlanner. You can manually change the BOM version in the **pom.xml** file after you generate your project.

8. Select the following extensions to include as dependencies:
  - RESTEasy JAX-RS (quarkus-resteasy)
  - RESTEasy Jackson (quarkus-resteasy-jackson)
  - OptaPlanner AI constraint solver(optaplanner-quarkus)
  - OptaPlanner Jackson (optaplanner-quarkus-jackson)  
Red Hat provides different levels of support for individual extensions on the list, which are indicated by labels next to the name of each extension:
    - *SUPPORTED* extensions are fully supported by Red Hat for use in enterprise applications in production environments.
    - *TECH-PREVIEW* extensions are subject to limited support by Red Hat in production environments under the [Technology Preview Features Support Scope](#) .
    - *DEV-SUPPORT* extensions are not supported by Red Hat for use in production environments, but the core functionalities that they provide are supported by Red Hat developers for use in developing new applications.
    - *DEPRECATED* extension are planned to be replaced with a newer technology or implementation that provides the same functionality.  
Unlabeled extensions are not supported by Red Hat for use in production environments.
9. Select *Generate your application* to confirm your choices and display the overlay screen with the download link for the archive that contains your generated project. The overlay screen also shows the custom command that you can use to compile and start your application.
10. Select **Download the ZIP** to save the archive with the generated project files to your system.

11. Extract the contents of the archive.
12. Navigate to the directory that contains your extracted project files:

```
┃ cd <directory_name>
```

13. Compile and start your application in development mode:

```
┃ ./mvnw compile quarkus:dev
```

## APPENDIX A. VERSIONING INFORMATION

Documentation last updated on Tuesday, March 8, 2022.

## APPENDIX B. CONTACT INFORMATION

Red Hat Process Automation Manager documentation team: [brms-docs@redhat.com](mailto:brms-docs@redhat.com)