



# Red Hat Enterprise Linux 8

## Configuring and managing networking

Managing network interfaces, firewalls, and advanced networking features



# Red Hat Enterprise Linux 8 Configuring and managing networking

---

Managing network interfaces, firewalls, and advanced networking features

## Legal Notice

Copyright © 2024 Red Hat, Inc.

The text of and illustrations in this document are licensed by Red Hat under a Creative Commons Attribution–Share Alike 3.0 Unported license ("CC-BY-SA"). An explanation of CC-BY-SA is available at

<http://creativecommons.org/licenses/by-sa/3.0/>

. In accordance with CC-BY-SA, if you distribute this document or an adaptation of it, you must provide the URL for the original version.

Red Hat, as the licensor of this document, waives the right to enforce, and agrees not to assert, Section 4d of CC-BY-SA to the fullest extent permitted by applicable law.

Red Hat, Red Hat Enterprise Linux, the Shadowman logo, the Red Hat logo, JBoss, OpenShift, Fedora, the Infinity logo, and RHCE are trademarks of Red Hat, Inc., registered in the United States and other countries.

Linux<sup>®</sup> is the registered trademark of Linus Torvalds in the United States and other countries.

Java<sup>®</sup> is a registered trademark of Oracle and/or its affiliates.

XFS<sup>®</sup> is a trademark of Silicon Graphics International Corp. or its subsidiaries in the United States and/or other countries.

MySQL<sup>®</sup> is a registered trademark of MySQL AB in the United States, the European Union and other countries.

Node.js<sup>®</sup> is an official trademark of Joyent. Red Hat is not formally related to or endorsed by the official Joyent Node.js open source or commercial project.

The OpenStack<sup>®</sup> Word Mark and OpenStack logo are either registered trademarks/service marks or trademarks/service marks of the OpenStack Foundation, in the United States and other countries and are used with the OpenStack Foundation's permission. We are not affiliated with, endorsed or sponsored by the OpenStack Foundation, or the OpenStack community.

All other trademarks are the property of their respective owners.

## Abstract

Using the networking capabilities of Red Hat Enterprise Linux (RHEL), you can configure your host to meet your organization's network and security requirements. For example: You can configure bonds, VLANs, bridges, tunnels and other network types to connect the host to the network. You can build performance-critical firewalls for the local host and the entire network. RHEL contains packet filtering software, such as the firewalld service, the nftables framework, and Express Data Path (XDP). RHEL also supports advanced networking features, such as policy-based routing and MultiPath TCP (MPTCP).

## Table of Contents

<b>MAKING OPEN SOURCE MORE INCLUSIVE</b> .....	<b>11</b>
<b>PROVIDING FEEDBACK ON RED HAT DOCUMENTATION</b> .....	<b>12</b>
<b>CHAPTER 1. IMPLEMENTING CONSISTENT NETWORK INTERFACE NAMING</b> .....	<b>13</b>
1.1. HOW THE UDEV DEVICE MANAGER RENAMES NETWORK INTERFACES	13
1.2. NETWORK INTERFACE NAMING POLICIES	14
1.3. NETWORK INTERFACE NAMING SCHEMES	15
1.4. DETERMINING A PREDICTABLE ROCE DEVICE NAME ON THE IBM Z PLATFORM	15
1.5. CUSTOMIZING THE PREFIX FOR ETHERNET INTERFACES DURING INSTALLATION	17
1.6. CONFIGURING USER-DEFINED NETWORK INTERFACE NAMES BY USING UDEV RULES	18
1.7. CONFIGURING USER-DEFINED NETWORK INTERFACE NAMES BY USING SYSTEMD LINK FILES	20
1.8. ASSIGNING ALTERNATIVE NAMES TO A NETWORK INTERFACE BY USING SYSTEMD LINK FILES	22
<b>CHAPTER 2. CONFIGURING AN ETHERNET CONNECTION</b> .....	<b>24</b>
2.1. CONFIGURING AN ETHERNET CONNECTION BY USING NMCLI	24
2.2. CONFIGURING AN ETHERNET CONNECTION BY USING THE NMCLI INTERACTIVE EDITOR	27
2.3. CONFIGURING AN ETHERNET CONNECTION BY USING NMTUI	30
2.4. CONFIGURING AN ETHERNET CONNECTION BY USING CONTROL-CENTER	33
2.5. CONFIGURING AN ETHERNET CONNECTION BY USING NM-CONNECTION-EDITOR	36
2.6. CONFIGURING AN ETHERNET CONNECTION WITH A STATIC IP ADDRESS BY USING NMSTATECTL	38
2.7. CONFIGURING AN ETHERNET CONNECTION WITH A STATIC IP ADDRESS BY USING THE NETWORK RHEL SYSTEM ROLE WITH AN INTERFACE NAME	40
2.8. CONFIGURING AN ETHERNET CONNECTION WITH A STATIC IP ADDRESS BY USING THE NETWORK RHEL SYSTEM ROLE WITH A DEVICE PATH	42
2.9. CONFIGURING AN ETHERNET CONNECTION WITH A DYNAMIC IP ADDRESS BY USING NMSTATECTL	43
2.10. CONFIGURING AN ETHERNET CONNECTION WITH A DYNAMIC IP ADDRESS BY USING THE NETWORK RHEL SYSTEM ROLE WITH AN INTERFACE NAME	45
2.11. CONFIGURING AN ETHERNET CONNECTION WITH A DYNAMIC IP ADDRESS BY USING THE NETWORK RHEL SYSTEM ROLE WITH A DEVICE PATH	46
2.12. CONFIGURING MULTIPLE ETHERNET INTERFACES BY USING A SINGLE CONNECTION PROFILE BY INTERFACE NAME	48
2.13. CONFIGURING A SINGLE CONNECTION PROFILE FOR MULTIPLE ETHERNET INTERFACES USING PCI IDS	49
<b>CHAPTER 3. CONFIGURING NETWORK BONDING</b> .....	<b>51</b>
3.1. UNDERSTANDING THE DEFAULT BEHAVIOR OF CONTROLLER AND PORT INTERFACES	51
3.2. UPSTREAM SWITCH CONFIGURATION DEPENDING ON THE BONDING MODES	51
3.3. CONFIGURING A NETWORK BOND BY USING NMCLI	52
3.4. CONFIGURING A NETWORK BOND BY USING THE RHEL WEB CONSOLE	55
3.5. CONFIGURING A NETWORK BOND BY USING NMTUI	58
3.6. CONFIGURING A NETWORK BOND BY USING NM-CONNECTION-EDITOR	61
3.7. CONFIGURING A NETWORK BOND BY USING NMSTATECTL	63
3.8. CONFIGURING A NETWORK BOND BY USING THE NETWORK RHEL SYSTEM ROLE	65
3.9. CREATING A NETWORK BOND TO ENABLE SWITCHING BETWEEN AN ETHERNET AND WIRELESS CONNECTION WITHOUT INTERRUPTING THE VPN	67
3.10. THE DIFFERENT NETWORK BONDING MODES	70
3.11. THE XMIT_HASH_POLICY BONDING PARAMETER	71
<b>CHAPTER 4. CONFIGURING NETWORK TEAMING</b> .....	<b>74</b>
4.1. UNDERSTANDING THE DEFAULT BEHAVIOR OF CONTROLLER AND PORT INTERFACES	74
4.2. UNDERSTANDING THE TEAMD SERVICE, RUNNERS, AND LINK-WATCHERS	74
4.3. CONFIGURING A NETWORK TEAM BY USING NMCLI	75

4.4. CONFIGURING A NETWORK TEAM BY USING THE RHEL WEB CONSOLE	78
4.5. CONFIGURING A NETWORK TEAM BY USING NM-CONNECTION-EDITOR	82
<b>CHAPTER 5. CONFIGURING VLAN TAGGING</b>	<b>85</b>
5.1. CONFIGURING VLAN TAGGING BY USING NMCLI	85
5.2. CONFIGURING VLAN TAGGING BY USING THE RHEL WEB CONSOLE	87
5.3. CONFIGURING VLAN TAGGING BY USING NMTUI	89
5.4. CONFIGURING VLAN TAGGING BY USING NM-CONNECTION-EDITOR	93
5.5. CONFIGURING VLAN TAGGING BY USING NMSTATECTL	95
5.6. CONFIGURING VLAN TAGGING BY USING THE NETWORK RHEL SYSTEM ROLE	97
5.7. ADDITIONAL RESOURCES	99
<b>CHAPTER 6. CONFIGURING A NETWORK BRIDGE</b>	<b>100</b>
6.1. CONFIGURING A NETWORK BRIDGE BY USING NMCLI	100
6.2. CONFIGURING A NETWORK BRIDGE BY USING THE RHEL WEB CONSOLE	103
6.3. CONFIGURING A NETWORK BRIDGE BY USING NMTUI	105
6.4. CONFIGURING A NETWORK BRIDGE BY USING NM-CONNECTION-EDITOR	109
6.5. CONFIGURING A NETWORK BRIDGE BY USING NMSTATECTL	111
6.6. CONFIGURING A NETWORK BRIDGE BY USING THE NETWORK RHEL SYSTEM ROLE	113
<b>CHAPTER 7. SETTING UP AN IPSEC VPN</b>	<b>116</b>
7.1. CONFIGURING A VPN CONNECTION WITH CONTROL-CENTER	116
7.2. CONFIGURING A VPN CONNECTION USING NM-CONNECTION-EDITOR	120
7.3. CONFIGURING AUTOMATIC DETECTION AND USAGE OF ESP HARDWARE OFFLOAD TO ACCELERATE AN IPSEC CONNECTION	123
7.4. CONFIGURING ESP HARDWARE OFFLOAD ON A BOND TO ACCELERATE AN IPSEC CONNECTION	124
<b>CHAPTER 8. CONFIGURING IP TUNNELS</b>	<b>126</b>
8.1. CONFIGURING AN IPIP TUNNEL USING NMCLI TO ENCAPSULATE IPV4 TRAFFIC IN IPV4 PACKETS	126
8.2. CONFIGURING A GRE TUNNEL USING NMCLI TO ENCAPSULATE LAYER-3 TRAFFIC IN IPV4 PACKETS	129
8.3. CONFIGURING A GRE-TAP TUNNEL TO TRANSFER ETHERNET FRAMES OVER IPV4	131
8.4. ADDITIONAL RESOURCES	134
<b>CHAPTER 9. USING A VXLAN TO CREATE A VIRTUAL LAYER-2 DOMAIN FOR VMS</b>	<b>135</b>
9.1. BENEFITS OF VXLANs	135
9.2. CONFIGURING THE ETHERNET INTERFACE ON THE HOSTS	136
9.3. CREATING A NETWORK BRIDGE WITH A VXLAN ATTACHED	137
9.4. CREATING A VIRTUAL NETWORK IN LIBVIRT WITH AN EXISTING BRIDGE	138
9.5. CONFIGURING VIRTUAL MACHINES TO USE VXLAN	139
<b>CHAPTER 10. MANAGING WIFI CONNECTIONS</b>	<b>141</b>
10.1. SUPPORTED WIFI SECURITY TYPES	141
10.2. CONNECTING TO A WIFI NETWORK BY USING NMCLI	142
10.3. CONNECTING TO A WIFI NETWORK BY USING THE GNOME SYSTEM MENU	143
10.4. CONNECTING TO A WIFI NETWORK BY USING THE GNOME SETTINGS APPLICATION	145
10.5. CONFIGURING A WIFI CONNECTION BY USING NMTUI	146
10.6. CONFIGURING A WIFI CONNECTION BY USING NM-CONNECTION-EDITOR	148
10.7. CONFIGURING A WIFI CONNECTION WITH 802.1X NETWORK AUTHENTICATION BY USING THE NETWORK RHEL SYSTEM ROLE	149
10.8. CONFIGURING A WIFI CONNECTION WITH 802.1X NETWORK AUTHENTICATION IN AN EXISTING PROFILE BY USING NMCLI	151
10.9. MANUALLY SETTING THE WIRELESS REGULATORY DOMAIN	152
<b>CHAPTER 11. CONFIGURING RHEL AS A WPA2 OR WPA3 PERSONAL ACCESS POINT</b>	<b>154</b>

<b>CHAPTER 12. USING MACSEC TO ENCRYPT LAYER-2 TRAFFIC IN THE SAME PHYSICAL NETWORK ...</b>	<b>157</b>
12.1. CONFIGURING A MACSEC CONNECTION USING NMCLI	157
12.2. ADDITIONAL RESOURCES	159
<b>CHAPTER 13. GETTING STARTED WITH IPVLAN .....</b>	<b>160</b>
13.1. IPVLAN MODES	160
13.2. COMPARISON OF IPVLAN AND MACVLAN	160
13.3. CREATING AND CONFIGURING THE IPVLAN DEVICE USING IPROUTE2	161
<b>CHAPTER 14. CONFIGURING NETWORKMANAGER TO IGNORE CERTAIN DEVICES .....</b>	<b>163</b>
14.1. PERMANENTLY CONFIGURING A DEVICE AS UNMANAGED IN NETWORKMANAGER	163
14.2. TEMPORARILY CONFIGURING A DEVICE AS UNMANAGED IN NETWORKMANAGER	164
<b>CHAPTER 15. CREATING A DUMMY INTERFACE .....</b>	<b>166</b>
15.1. CREATING A DUMMY INTERFACE WITH BOTH AN IPV4 AND IPV6 ADDRESS USING NMCLI	166
<b>CHAPTER 16. USING NETWORKMANAGER TO DISABLE IPV6 FOR A SPECIFIC CONNECTION .....</b>	<b>167</b>
16.1. DISABLING IPV6 ON A CONNECTION USING NMCLI	167
<b>CHAPTER 17. CHANGING A HOSTNAME .....</b>	<b>169</b>
17.1. CHANGING A HOSTNAME USING NMCLI	169
17.2. CHANGING A HOSTNAME USING HOSTNAMECTL	169
<b>CHAPTER 18. CONFIGURING NETWORKMANAGER DHCP SETTINGS .....</b>	<b>171</b>
18.1. CHANGING THE DHCP CLIENT OF NETWORKMANAGER	171
18.2. CONFIGURING THE DHCP BEHAVIOR OF A NETWORKMANAGER CONNECTION	171
<b>CHAPTER 19. RUNNING DHCLIENT EXIT HOOKS USING NETWORKMANAGER A DISPATCHER SCRIPT</b>	<b>173</b>
19.1. THE CONCEPT OF NETWORKMANAGER DISPATCHER SCRIPTS	173
19.2. CREATING A NETWORKMANAGER DISPATCHER SCRIPT THAT RUNS DHCLIENT EXIT HOOKS	173
<b>CHAPTER 20. MANUALLY CONFIGURING THE /ETC/RESOLV.CONF FILE .....</b>	<b>175</b>
20.1. DISABLING DNS PROCESSING IN THE NETWORKMANAGER CONFIGURATION	175
20.2. REPLACING /ETC/RESOLV.CONF WITH A SYMBOLIC LINK TO MANUALLY CONFIGURE DNS SETTINGS	176
<b>CHAPTER 21. CONFIGURING THE ORDER OF DNS SERVERS .....</b>	<b>177</b>
21.1. HOW NETWORKMANAGER ORDERS DNS SERVERS IN /ETC/RESOLV.CONF	177
Default values of DNS priority parameters	177
Valid DNS priority values:	177
21.2. SETTING A NETWORKMANAGER-WIDE DEFAULT DNS SERVER PRIORITY VALUE	178
21.3. SETTING THE DNS PRIORITY OF A NETWORKMANAGER CONNECTION	179
<b>CHAPTER 22. USING DIFFERENT DNS SERVERS FOR DIFFERENT DOMAINS .....</b>	<b>180</b>
22.1. USING DNSMASQ IN NETWORKMANAGER TO SEND DNS REQUESTS FOR A SPECIFIC DOMAIN TO A SELECTED DNS SERVER	180
22.2. USING SYSTEMD-RESOLVED IN NETWORKMANAGER TO SEND DNS REQUESTS FOR A SPECIFIC DOMAIN TO A SELECTED DNS SERVER	182
<b>CHAPTER 23. MANAGING THE DEFAULT GATEWAY SETTING .....</b>	<b>185</b>
23.1. SETTING THE DEFAULT GATEWAY ON AN EXISTING CONNECTION BY USING NMCLI	185
23.2. SETTING THE DEFAULT GATEWAY ON AN EXISTING CONNECTION BY USING THE NMCLI INTERACTIVE MODE	186
23.3. SETTING THE DEFAULT GATEWAY ON AN EXISTING CONNECTION BY USING NM-CONNECTION-EDITOR	187
23.4. SETTING THE DEFAULT GATEWAY ON AN EXISTING CONNECTION BY USING CONTROL-CENTER	189

23.5. SETTING THE DEFAULT GATEWAY ON AN EXISTING CONNECTION BY USING NMSTATECTL	190
23.6. SETTING THE DEFAULT GATEWAY ON AN EXISTING CONNECTION BY USING THE NETWORK RHEL SYSTEM ROLE	191
23.7. SETTING THE DEFAULT GATEWAY ON AN EXISTING CONNECTION WHEN USING THE LEGACY NETWORK SCRIPTS	192
23.8. HOW NETWORKMANAGER MANAGES MULTIPLE DEFAULT GATEWAYS	193
23.9. CONFIGURING NETWORKMANAGER TO AVOID USING A SPECIFIC PROFILE TO PROVIDE A DEFAULT GATEWAY	194
23.10. FIXING UNEXPECTED ROUTING BEHAVIOR DUE TO MULTIPLE DEFAULT GATEWAYS	195
<b>CHAPTER 24. CONFIGURING STATIC ROUTES</b>	<b>197</b>
24.1. EXAMPLE OF A NETWORK THAT REQUIRES STATIC ROUTES	197
24.2. HOW TO USE THE NMCLI COMMAND TO CONFIGURE A STATIC ROUTE	199
24.3. CONFIGURING A STATIC ROUTE BY USING NMCLI	200
24.4. CONFIGURING A STATIC ROUTE BY USING NMTUI	201
24.5. CONFIGURING A STATIC ROUTE BY USING CONTROL-CENTER	203
24.6. CONFIGURING A STATIC ROUTE BY USING NM-CONNECTION-EDITOR	205
24.7. CONFIGURING A STATIC ROUTE BY USING THE NMCLI INTERACTIVE MODE	206
24.8. CONFIGURING A STATIC ROUTE BY USING NMSTATECTL	208
24.9. CONFIGURING A STATIC ROUTE BY USING THE NETWORK RHEL SYSTEM ROLE	209
24.10. CREATING STATIC ROUTES CONFIGURATION FILES IN KEY-VALUE FORMAT WHEN USING THE LEGACY NETWORK SCRIPTS	211
24.11. CREATING STATIC ROUTES CONFIGURATION FILES IN IP-COMMAND FORMAT WHEN USING THE LEGACY NETWORK SCRIPTS	212
<b>CHAPTER 25. CONFIGURING POLICY-BASED ROUTING TO DEFINE ALTERNATIVE ROUTES</b>	<b>215</b>
25.1. ROUTING TRAFFIC FROM A SPECIFIC SUBNET TO A DIFFERENT DEFAULT GATEWAY BY USING NMCLI	215
25.2. ROUTING TRAFFIC FROM A SPECIFIC SUBNET TO A DIFFERENT DEFAULT GATEWAY BY USING THE NETWORK RHEL SYSTEM ROLE	219
25.3. OVERVIEW OF CONFIGURATION FILES INVOLVED IN POLICY-BASED ROUTING WHEN USING THE LEGACY NETWORK SCRIPTS	223
25.4. ROUTING TRAFFIC FROM A SPECIFIC SUBNET TO A DIFFERENT DEFAULT GATEWAY BY USING THE LEGACY NETWORK SCRIPTS	223
<b>CHAPTER 26. REUSING THE SAME IP ADDRESS ON DIFFERENT INTERFACES</b>	<b>229</b>
26.1. PERMANENTLY REUSING THE SAME IP ADDRESS ON DIFFERENT INTERFACES	229
26.2. TEMPORARILY REUSING THE SAME IP ADDRESS ON DIFFERENT INTERFACES	230
26.3. ADDITIONAL RESOURCES	232
<b>CHAPTER 27. STARTING A SERVICE WITHIN AN ISOLATED VRF NETWORK</b>	<b>233</b>
27.1. CONFIGURING A VRF DEVICE	233
27.2. STARTING A SERVICE WITHIN AN ISOLATED VRF NETWORK	234
<b>CHAPTER 28. CONFIGURING ETHTOOL SETTINGS IN NETWORKMANAGER CONNECTION PROFILES</b>	<b>237</b>
28.1. CONFIGURING AN ETHTOOL OFFLOAD FEATURE BY USING NMCLI	237
28.2. CONFIGURING AN ETHTOOL OFFLOAD FEATURE BY USING THE NETWORK RHEL SYSTEM ROLE	238
28.3. CONFIGURING AN ETHTOOL COALESCE SETTINGS BY USING NMCLI	239
28.4. CONFIGURING AN ETHTOOL COALESCE SETTINGS BY USING THE NETWORK RHEL SYSTEM ROLE	240
28.5. INCREASING THE RING BUFFER SIZE TO REDUCE A HIGH PACKET DROP RATE BY USING NMCLI	242
28.6. INCREASING THE RING BUFFER SIZE TO REDUCE A HIGH PACKET DROP RATE BY USING THE NETWORK RHEL SYSTEM ROLE	243
<b>CHAPTER 29. INTRODUCTION TO NETWORKMANAGER DEBUGGING</b>	<b>246</b>



29.1. INTRODUCTION TO NETWORKMANAGER REAPPLY METHOD	246
29.2. SETTING THE NETWORKMANAGER LOG LEVEL	248
29.3. TEMPORARILY SETTING LOG LEVELS AT RUN TIME USING NMCLI	249
29.4. VIEWING NETWORKMANAGER LOGS	250
29.5. DEBUGGING LEVELS AND DOMAINS	250
<b>CHAPTER 30. USING LLDP TO DEBUG NETWORK CONFIGURATION PROBLEMS</b> .....	<b>252</b>
30.1. DEBUGGING AN INCORRECT VLAN CONFIGURATION USING LLDP INFORMATION	252
<b>CHAPTER 31. LINUX TRAFFIC CONTROL</b> .....	<b>255</b>
31.1. OVERVIEW OF QUEUING DISCIPLINES	255
31.2. INSPECTING QDISCS OF A NETWORK INTERFACE USING THE TC UTILITY	255
31.3. UPDATING THE DEFAULT QDISC	256
31.4. TEMPORARILY SETTING THE CURRENT QDISC OF A NETWORK INTERFACE USING THE TC UTILITY	257
31.5. PERMANENTLY SETTING THE CURRENT QDISC OF A NETWORK INTERFACE USING NETWORKMANAGER	257
31.6. AVAILABLE QDISCS IN RHEL	258
<b>CHAPTER 32. AUTHENTICATING A RHEL CLIENT TO THE NETWORK BY USING THE 802.1X STANDARD WITH A CERTIFICATE STORED ON THE FILE SYSTEM</b> .....	<b>261</b>
32.1. CONFIGURING 802.1X NETWORK AUTHENTICATION ON AN EXISTING ETHERNET CONNECTION BY USING NMCLI	261
32.2. CONFIGURING A STATIC ETHERNET CONNECTION WITH 802.1X NETWORK AUTHENTICATION BY USING NMSTATECTL	262
32.3. CONFIGURING A STATIC ETHERNET CONNECTION WITH 802.1X NETWORK AUTHENTICATION BY USING THE NETWORK RHEL SYSTEM ROLE	264
<b>CHAPTER 33. SETTING UP AN 802.1X NETWORK AUTHENTICATION SERVICE FOR LAN CLIENTS BY USING HOSTAPD WITH FREERADIUS BACKEND</b> .....	<b>267</b>
33.1. PREREQUISITES	267
33.2. SETTING UP THE BRIDGE ON THE AUTHENTICATOR	267
33.3. CERTIFICATE REQUIREMENTS BY FREERADIUS	268
33.4. CREATING A SET OF CERTIFICATES ON A FREERADIUS SERVER FOR TESTING PURPOSES	269
33.5. CONFIGURING FREERADIUS TO AUTHENTICATE NETWORK CLIENTS SECURELY BY USING EAP	271
33.6. CONFIGURING HOSTAPD AS AN AUTHENTICATOR IN A WIRED NETWORK	274
33.7. TESTING EAP-TTLS AUTHENTICATION AGAINST A FREERADIUS SERVER OR AUTHENTICATOR	277
33.8. TESTING EAP-TLS AUTHENTICATION AGAINST A FREERADIUS SERVER OR AUTHENTICATOR	278
33.9. BLOCKING AND ALLOWING TRAFFIC BASED ON HOSTAPD AUTHENTICATION EVENTS	280
<b>CHAPTER 34. GETTING STARTED WITH MULTIPATH TCP</b> .....	<b>283</b>
34.1. UNDERSTANDING MPTCP	283
34.2. PREPARING RHEL TO ENABLE MPTCP SUPPORT	283
34.3. USING IPROUTE2 TO TEMPORARILY CONFIGURE AND ENABLE MULTIPLE PATHS FOR MPTCP APPLICATIONS	286
34.4. PERMANENTLY CONFIGURING MULTIPLE PATHS FOR MPTCP APPLICATIONS	288
34.5. MONITORING MPTCP SUB-FLOWS	290
34.6. DISABLING MULTIPATH TCP IN THE KERNEL	292
<b>CHAPTER 35. LEGACY NETWORK SCRIPTS SUPPORT IN RHEL</b> .....	<b>294</b>
35.1. INSTALLING THE LEGACY NETWORK SCRIPTS	294
<b>CHAPTER 36. CONFIGURING IP NETWORKING WITH IFCFG FILES</b> .....	<b>295</b>
36.1. CONFIGURING AN INTERFACE WITH STATIC NETWORK SETTINGS USING IFCFG FILES	295
36.2. CONFIGURING AN INTERFACE WITH DYNAMIC NETWORK SETTINGS USING IFCFG FILES	296
36.3. MANAGING SYSTEM-WIDE AND PRIVATE CONNECTION PROFILES WITH IFCFG FILES	296

<b>CHAPTER 37. NETWORKMANAGER CONNECTION PROFILES IN KEYFILE FORMAT</b> .....	<b>298</b>
37.1. THE KEYFILE FORMAT OF NETWORKMANAGER PROFILES	298
37.2. USING NMCLI TO CREATE KEYFILE CONNECTION PROFILES IN OFFLINE MODE	299
37.3. MANUALLY CREATING A NETWORKMANAGER PROFILE IN KEYFILE FORMAT	301
37.4. THE DIFFERENCES IN INTERFACE RENAMING WITH PROFILES IN IFCFG AND KEYFILE FORMAT	302
37.5. MIGRATING NETWORKMANAGER PROFILES FROM IFCFG TO KEYFILE FORMAT	303
<b>CHAPTER 38. SYSTEMD NETWORK TARGETS AND SERVICES</b> .....	<b>305</b>
38.1. DIFFERENCES BETWEEN THE NETWORK AND NETWORK-ONLINE SYSTEMD TARGET	305
38.2. OVERVIEW OF NETWORKMANAGER-WAIT-ONLINE	305
38.3. CONFIGURING A SYSTEMD SERVICE TO START AFTER THE NETWORK HAS BEEN STARTED	306
<b>CHAPTER 39. INTRODUCTION TO NMSTATE</b> .....	<b>307</b>
39.1. USING THE LIBNMSTATE LIBRARY IN A PYTHON APPLICATION	307
39.2. UPDATING THE CURRENT NETWORK CONFIGURATION USING NMSTATECTL	307
39.3. NETWORK STATES FOR THE NETWORK RHEL SYSTEM ROLE	308
39.4. ADDITIONAL RESOURCES	309
<b>CHAPTER 40. USING AND CONFIGURING FIREWALLD</b> .....	<b>310</b>
40.1. WHEN TO USE FIREWALLD, NFTABLES, OR IPTABLES	310
40.2. FIREWALL ZONES	310
40.3. FIREWALL POLICIES	312
40.4. FIREWALL RULES	313
40.5. ZONE CONFIGURATION FILES	313
40.6. PREDEFINED FIREWALLD SERVICES	314
40.7. WORKING WITH FIREWALLD ZONES	314
40.7.1. Customizing firewall settings for a specific zone to enhance security	315
40.7.2. Changing the default zone	316
40.7.3. Assigning a network interface to a zone	316
40.7.4. Assigning a zone to a connection using nmcli	317
40.7.5. Manually assigning a zone to a network connection in a connection profile file	317
40.7.6. Manually assigning a zone to a network connection in an ifcfg file	318
40.7.7. Creating a new zone	318
40.7.8. Using zone targets to set default behavior for incoming traffic	319
40.8. CONTROLLING NETWORK TRAFFIC USING FIREWALLD	320
40.8.1. Controlling traffic with predefined services using the CLI	320
40.8.2. Controlling traffic with predefined services using the GUI	321
40.8.3. Configuring firewalld to allow hosting a secure web server	322
40.8.4. Closing unused or unnecessary ports to enhance network security	323
40.8.5. Controlling traffic through the CLI	324
40.8.6. Controlling traffic with protocols using GUI	325
40.9. USING ZONES TO MANAGE INCOMING TRAFFIC DEPENDING ON A SOURCE	325
40.9.1. Adding a source	325
40.9.2. Removing a source	326
40.9.3. Removing a source port	327
40.9.4. Using zones and sources to allow a service for only a specific domain	327
40.10. FILTERING FORWARDED TRAFFIC BETWEEN ZONES	328
40.10.1. The relationship between policy objects and zones	328
40.10.2. Using priorities to sort policies	328
40.10.3. Using policy objects to filter traffic between locally hosted containers and a network physically connected to the host	329
40.10.4. Setting the default target of policy objects	330
40.10.5. Using DNAT to forward HTTPS traffic to a different host	330
40.11. CONFIGURING NAT USING FIREWALLD	332

40.11.1. Network address translation types	332
40.11.2. Configuring IP address masquerading	333
40.11.3. Using DNAT to forward incoming HTTP traffic	333
40.11.4. Redirecting traffic from a non-standard port to make the web service accessible on a standard port	335
40.12. MANAGING ICMP REQUESTS	336
40.12.1. Configuring ICMP filtering	336
40.13. SETTING AND CONTROLLING IP SETS USING FIREWALLD	337
40.13.1. Configuring dynamic updates for allowlisting with IP sets	338
40.14. PRIORITIZING RICH RULES	339
40.14.1. How the priority parameter organizes rules into different chains	339
40.14.2. Setting the priority of a rich rule	340
40.15. CONFIGURING FIREWALL LOCKDOWN	340
40.15.1. Configuring lockdown using CLI	340
40.15.2. Overview of lockdown allowlist configuration files	341
40.16. ENABLING TRAFFIC FORWARDING BETWEEN DIFFERENT INTERFACES OR SOURCES WITHIN A FIREWALLD ZONE	341
40.16.1. The difference between intra-zone forwarding and zones with the default target set to ACCEPT	342
40.16.2. Using intra-zone forwarding to forward traffic between an Ethernet and Wi-Fi network	342
40.17. CONFIGURING FIREWALLD BY USING RHEL SYSTEM ROLES	343
40.17.1. Introduction to the firewall RHEL system role	343
40.17.2. Resetting the firewalld settings by using a RHEL system role	344
40.17.3. Forwarding incoming traffic in firewalld from one local port to a different local port by using a RHEL system role	345
40.17.4. Managing ports in firewalld by using a RHEL system role	346
40.17.5. Configuring a firewalld DMZ zone by using a RHEL system role	347
<b>CHAPTER 41. GETTING STARTED WITH NFTABLES</b> .....	<b>350</b>
41.1. MIGRATING FROM IPTABLES TO NFTABLES	350
41.1.1. When to use firewalld, nftables, or iptables	350
41.1.2. Converting iptables and ip6tables rule sets to nftables	350
41.1.3. Converting single iptables and ip6tables rules to nftables	352
41.1.4. Comparison of common iptables and nftables commands	352
41.2. WRITING AND EXECUTING NFTABLES SCRIPTS	353
41.2.1. Supported nftables script formats	353
41.2.2. Running nftables scripts	354
41.2.3. Using comments in nftables scripts	355
41.2.4. Using variables in nftables script	355
41.2.5. Including files in nftables scripts	356
41.2.6. Automatically loading nftables rules when the system boots	356
41.3. CREATING AND MANAGING NFTABLES TABLES, CHAINS, AND RULES	357
41.3.1. Basics of nftables tables	357
41.3.2. Basics of nftables chains	357
Chain types	358
Chain priorities	358
Chain policies	359
41.3.3. Basics of nftables rules	359
41.3.4. Managing tables, chains, and rules using nft commands	359
41.4. CONFIGURING NAT USING NFTABLES	362
41.4.1. NAT types	362
41.4.2. Configuring masquerading using nftables	363
41.4.3. Configuring source NAT using nftables	363
41.4.4. Configuring destination NAT using nftables	364

41.4.5. Configuring a redirect using nftables	365
41.4.6. Configuring flowtable by using nftables	366
41.5. USING SETS IN NFTABLES COMMANDS	367
41.5.1. Using anonymous sets in nftables	367
41.5.2. Using named sets in nftables	367
41.5.3. Additional resources	369
41.6. USING VERDICT MAPS IN NFTABLES COMMANDS	369
41.6.1. Using anonymous maps in nftables	369
41.6.2. Using named maps in nftables	370
41.6.3. Additional resources	372
41.7. EXAMPLE: PROTECTING A LAN AND DMZ USING AN NFTABLES SCRIPT	372
41.7.1. Network conditions	372
41.7.2. Security requirements to the firewall script	372
41.7.3. Configuring logging of dropped packets to a file	373
41.7.4. Writing and activating the nftables script	374
41.8. CONFIGURING PORT FORWARDING USING NFTABLES	377
41.8.1. Forwarding incoming packets to a different local port	377
41.8.2. Forwarding incoming packets on a specific local port to a different host	378
41.9. USING NFTABLES TO LIMIT THE AMOUNT OF CONNECTIONS	378
41.9.1. Limiting the number of connections using nftables	378
41.9.2. Blocking IP addresses that attempt more than ten new incoming TCP connections within one minute	379
41.10. DEBUGGING NFTABLES RULES	380
41.10.1. Creating a rule with a counter	380
41.10.2. Adding a counter to an existing rule	380
41.10.3. Monitoring packets that match an existing rule	381
41.11. BACKING UP AND RESTORING THE NFTABLES RULE SET	382
41.11.1. Backing up the nftables rule set to a file	382
41.11.2. Restoring the nftables rule set from a file	383
41.12. ADDITIONAL RESOURCES	383
<b>CHAPTER 42. USING XDP-FILTER FOR HIGH-PERFORMANCE TRAFFIC FILTERING TO PREVENT DDOS ATTACKS</b>	<b>384</b>
42.1. DROPPING NETWORK PACKETS THAT MATCH AN XDP-FILTER RULE	384
42.2. DROPPING ALL NETWORK PACKETS EXCEPT THE ONES THAT MATCH AN XDP-FILTER RULE	385
<b>CHAPTER 43. CAPTURING NETWORK PACKETS</b>	<b>388</b>
43.1. USING XDPDUMP TO CAPTURE NETWORK PACKETS INCLUDING PACKETS DROPPED BY XDP PROGRAMS	388
43.2. ADDITIONAL RESOURCES	389
<b>CHAPTER 44. UNDERSTANDING THE EBPF NETWORKING FEATURES IN RHEL 8</b>	<b>390</b>
44.1. OVERVIEW OF NETWORKING EBPF FEATURES IN RHEL 8	390
XDP	390
AF_XDP	391
Traffic Control	392
Socket filter	392
Control Groups	392
Stream Parser	393
SO_REUSEPORT socket selection	393
Flow dissector	393
TCP Congestion Control	393
Routes with encapsulation	393
Socket lookup	394

44.2. OVERVIEW OF XDP FEATURES IN RHEL 8 BY NETWORK CARDS	394
<b>CHAPTER 45. NETWORK TRACING USING THE BPF COMPILER COLLECTION</b>	<b>396</b>
45.1. INSTALLING THE BCC-TOOLS PACKAGE	396
45.2. DISPLAYING TCP CONNECTIONS ADDED TO THE KERNEL'S ACCEPT QUEUE	396
45.3. TRACING OUTGOING TCP CONNECTION ATTEMPTS	397
45.4. MEASURING THE LATENCY OF OUTGOING TCP CONNECTIONS	398
45.5. DISPLAYING DETAILS ABOUT TCP PACKETS AND SEGMENTS THAT WERE DROPPED BY THE KERNEL	398
45.6. TRACING TCP SESSIONS	399
45.7. TRACING TCP RETRANSMISSIONS	400
45.8. DISPLAYING TCP STATE CHANGE INFORMATION	400
45.9. SUMMARIZING AND AGGREGATING TCP TRAFFIC SENT TO SPECIFIC SUBNETS	401
45.10. DISPLAYING THE NETWORK THROUGHPUT BY IP ADDRESS AND PORT	402
45.11. TRACING ESTABLISHED TCP CONNECTIONS	402
45.12. TRACING IPV4 AND IPV6 LISTEN ATTEMPTS	403
45.13. SUMMARIZING THE SERVICE TIME OF SOFT INTERRUPTS	403
45.14. SUMMARIZING PACKETS SIZE AND COUNT ON A NETWORK INTERFACE	404
45.15. ADDITIONAL RESOURCES	405
<b>CHAPTER 46. CONFIGURING NETWORK DEVICES TO ACCEPT TRAFFIC FROM ALL MAC ADDRESSES</b>	<b>406</b>
46.1. TEMPORARILY CONFIGURING A DEVICE TO ACCEPT ALL TRAFFIC	406
46.2. PERMANENTLY CONFIGURING A NETWORK DEVICE TO ACCEPT ALL TRAFFIC USING NMCLI	407
46.3. PERMANENTLY CONFIGURING A NETWORK DEVICE TO ACCEPT ALL TRAFFIC USING NMSTATECTL	407
<b>CHAPTER 47. MIRRORING A NETWORK INTERFACE BY USING NMCLI</b>	<b>409</b>
<b>CHAPTER 48. USING NMSTATE-AUTOCONF TO AUTOMATICALLY CONFIGURE THE NETWORK STATE USING LLDP</b>	<b>411</b>
48.1. USING NMSTATE-AUTOCONF TO AUTOMATICALLY CONFIGURE NETWORK INTERFACES	411
<b>CHAPTER 49. CONFIGURING 802.3 LINK SETTINGS</b>	<b>414</b>
49.1. CONFIGURING 802.3 LINK SETTINGS USING THE NMCLI UTILITY	414
<b>CHAPTER 50. GETTING STARTED WITH DPDK</b>	<b>416</b>
50.1. INSTALLING THE DPDK PACKAGE	416
50.2. ADDITIONAL RESOURCES	416
<b>CHAPTER 51. GETTING STARTED WITH TIPC</b>	<b>417</b>
51.1. THE ARCHITECTURE OF TIPC	417
51.2. LOADING THE TIPC MODULE WHEN THE SYSTEM BOOTS	417
51.3. CREATING A TIPC NETWORK	418
51.4. ADDITIONAL RESOURCES	419
<b>CHAPTER 52. AUTOMATICALLY CONFIGURING NETWORK INTERFACES IN PUBLIC CLOUDS USING NM-CLOUD-SETUP</b>	<b>420</b>
52.1. CONFIGURING AND PRE-DEPLOYING NM-CLOUD-SETUP	420
52.2. UNDERSTANDING THE ROLE OF IMDSV2 AND NM-CLOUD-SETUP IN THE RHEL EC2 INSTANCE	421



## MAKING OPEN SOURCE MORE INCLUSIVE

Red Hat is committed to replacing problematic language in our code, documentation, and web properties. We are beginning with these four terms: master, slave, blacklist, and whitelist. Because of the enormity of this endeavor, these changes will be implemented gradually over several upcoming releases. For more details, see [our CTO Chris Wright's message](#).

## PROVIDING FEEDBACK ON RED HAT DOCUMENTATION

We appreciate your feedback on our documentation. Let us know how we can improve it.

### Submitting feedback through Jira (account required)

1. Log in to the [Jira](#) website.
2. Click **Create** in the top navigation bar.
3. Enter a descriptive title in the **Summary** field.
4. Enter your suggestion for improvement in the **Description** field. Include links to the relevant parts of the documentation.
5. Click **Create** at the bottom of the dialogue.



# CHAPTER 1. IMPLEMENTING CONSISTENT NETWORK INTERFACE NAMING

The **udev** device manager implements consistent device naming in Red Hat Enterprise Linux. The device manager supports different naming schemes and, by default, assigns fixed names based on firmware, topology, and location information.

Without consistent device naming, the Linux kernel assigns names to network interfaces by combining a fixed prefix and an index. The index increases as the kernel initializes the network devices. For example, **eth0** represents the first Ethernet device being probed on start-up. If you add another network interface controller to the system, the assignment of the kernel device names is no longer fixed because, after a reboot, the devices can initialize in a different order. In that case, the kernel can name the devices differently.

To solve this problem, **udev** assigns consistent device names. This has the following advantages:

- Device names are stable across reboots.
- Device names stay fixed even if you add or remove hardware.
- Defective hardware can be seamlessly replaced.
- The network naming is stateless and does not require explicit configuration files.



## WARNING

Generally, Red Hat does not support systems where consistent device naming is disabled. For exceptions, see the [ls it safe to set net.ifnames=0](#) solution.

## 1.1. HOW THE UDEV DEVICE MANAGER RENAMES NETWORK INTERFACES

To implement a consistent naming scheme for network interfaces, the **udev** device manager processes the following rule files in the listed order:

1. Optional: **/usr/lib/udev/rules.d/60-net.rules**

The **/usr/lib/udev/rules.d/60-net.rules** file defines that the deprecated **/usr/lib/udev/rename\_device** helper utility searches for the **HWADDR** parameter in **/etc/sysconfig/network-scripts/ifcfg-\*** files. If the value set in the variable matches the MAC address of an interface, the helper utility renames the interface to the name set in the **DEVICE** parameter of the **ifcfg** file.

If the system uses only NetworkManager connection profiles in keyfile format, **udev** skips this step.

2. Only on Dell systems: **/usr/lib/udev/rules.d/71-biosdevname.rules**

This file exists only if the **biosdevname** package is installed, and the rules file defines that the **biosdevname** utility renames the interface according to its naming policy, if it was not renamed in the previous step.

**NOTE**

Install and use **biosdevname** only on Dell systems.

3. **/usr/lib/udev/rules.d/75-net-description.rules**

This file defines how **udev** examines the network interface and sets the properties in **udev-**internal variables. These variables are then processed in the next step by the **/usr/lib/udev/rules.d/80-net-setup-link.rules** file. Some of the properties can be undefined.

4. **/usr/lib/udev/rules.d/80-net-setup-link.rules**

This file calls the **net\_setup\_link** builtin of the **udev** service, and **udev** renames the interface based on the order of the policies in the **NamePolicy** parameter in the **/usr/lib/systemd/network/99-default.link** file. For further details, see [Network interface naming policies](#).

If none of the policies applies, **udev** does not rename the interface.

**Additional resources**

- [Why are systemd network interface names different between major RHEL versions](#) solution

## 1.2. NETWORK INTERFACE NAMING POLICIES

By default, the **udev** device manager uses the **/usr/lib/systemd/network/99-default.link** file to determine which device naming policies to apply when it renames interfaces. The **NamePolicy** parameter in this file defines which policies **udev** uses and in which order:

**NamePolicy=kernel database onboard slot path**

The following table describes the different actions of **udev** based on which policy matches first as specified by the **NamePolicy** parameter:

Policy	Description	Example name
kernel	If the kernel indicates that a device name is predictable, <b>udev</b> does not rename this device.	<b>lo</b>
database	This policy assigns names based on mappings in the <b>udev</b> hardware database. For details, see the <b>hwdb(7)</b> man page.	<b>idrac</b>
onboard	Device names incorporate firmware or BIOS-provided index numbers for onboard devices.	<b>eno1</b>
slot	Device names incorporate firmware or BIOS-provided PCI Express (PCIe) hot-plug slot-index numbers.	<b>ens1</b>
path	Device names incorporate the physical location of the connector of the hardware.	<b>enp1s0</b>

Policy	Description	Example name
mac	Device names incorporate the MAC address. By default, Red Hat Enterprise Linux does not use this policy, but administrators can enable it.	<b>enx525400d5e0fb</b>

### Additional resources

- [How the udev device manager renames network interfaces](#)
- **systemd.link(5)** man page

## 1.3. NETWORK INTERFACE NAMING SCHEMES

The **udev** device manager uses certain stable interface attributes to generate consistent device names. For details about the naming schemes for different device types and platforms, see the **systemd.net-naming-scheme(7)** man page.

## 1.4. DETERMINING A PREDICTABLE ROCE DEVICE NAME ON THE IBM Z PLATFORM

On Red Hat Enterprise Linux (RHEL) 8.7 and later, the **udev** device manager sets names for RoCE interfaces on IBM Z as follows:

- If the host enforces a unique identifier (UID) for a device, **udev** assigns a consistent device name that is based on the UID, for example **eno<UID\_in\_decimal>**.
- If the host does not enforce a UID for a device, the behavior depends on your settings:
  - By default, **udev** uses unpredictable names for the device.
  - If you set the **net.naming-scheme=rhel-8.7** kernel command line option, **udev** assigns a consistent device name that is based on the function identifier (FID) of the device, for example **ens<FID\_in\_decimal>**.

Manually configure predictable device name for RoCE interfaces on IBM Z in the following cases:

- Your host runs RHEL 8.6 or earlier and enforces a UID for a device, and you plan to update to RHEL 8.7 or later.  
After an update to RHEL 8.7 or later, **udev** uses consistent interface names. However, if you used unpredictable device names before the update, NetworkManager connection profiles still use these names and fail to activate until you update the affected profiles.
- Your host runs RHEL 8.7 or later and does not enforce a UID, and you plan to upgrade to RHEL 9.

Before you can use a **udev** rule or a **systemd** link file to rename an interface manually, you must determine a predictable device name.

### Prerequisites

- An RoCE controller is installed in the system.

- The **sysfsutils** package is installed.

## Procedure

1. Display the available network devices, and note the names of the RoCE devices:

```
# ip link show
...
2: enP5165p0s0: <BROADCAST,MULTICAST,UP,LOWER_UP> mtu 1500 qdisc mq state
UP mode DEFAULT group default qlen 1000
...
```

2. Display the device path in the **/sys/** file system:

```
# systool -c net -p
Class = "net"

Class Device = "enP5165p0s0"
Class Device path = "/sys/devices/pci142d:00/142d:00:00.0/net/enP5165p0s0"
Device = "142d:00:00.0"
Device path = "/sys/devices/pci142d:00/142d:00:00.0"
```

Use the path shown in the **Device path** field in the next steps.

3. Display the value of the **<device\_path>/uid\_id\_unique** file, for example:

```
# cat /sys/devices/pci142d:00/142d:00:00.0/uid_id_unique
```

The displayed value indicates whether UID uniqueness is enforced or not, and you require this value in later steps.

4. Determine a unique identifier:

- If UID uniqueness is enforced (**1**), display the UID stored in the **<device\_path>/uid** file, for example:

```
# cat /sys/devices/pci142d:00/142d:00:00.0/uid
```

- If UID uniqueness is not enforced (**0**), display the FID stored in the **<device\_path>/function\_id** file, for example:

```
# cat /sys/devices/pci142d:00/142d:00:00.0/function_id
```

The outputs of the commands display the UID and FID values in hexadecimal.

5. Convert the hexadecimal identifier to decimal, for example:

```
# printf "%d\n" 0x00001402
5122
```

6. To determine the predictable device name, append the identifier in decimal format to the corresponding prefix based on whether UID uniqueness is enforced or not:

- If UID uniqueness is enforced, append the identifier to the **eno** prefix, for example **eno5122**.
- If UID uniqueness is not enforced, append the identifier to the **ens** prefix, for example **ens5122**.

### Next steps

- Use one of the following methods to rename the interface to the predictable name:
  - [Configuring user-defined network interface names by using udev rules](#)
  - [Configuring user-defined network interface names by using systemd link files](#)

### Additional resources

- IBM documentation: [Network interface names](#)
- **systemd.net-naming-scheme(7)** man page

## 1.5. CUSTOMIZING THE PREFIX FOR ETHERNET INTERFACES DURING INSTALLATION

If you do not want to use the default device-naming policy for Ethernet interfaces, you can set a custom device prefix during the Red Hat Enterprise Linux (RHEL) installation.



### IMPORTANT

Red Hat supports systems with customized Ethernet prefixes only if you set the prefix during the RHEL installation. Using the **prefixdevname** utility on already deployed systems is not supported.

If you set a device prefix during the installation, the **udev** service uses the **<prefix><index>** format for Ethernet interfaces after the installation. For example, if you set the prefix **net**, the service assigns the names **net0**, **net1**, and so on to the Ethernet interfaces.

The **udev** service appends the index to the custom prefix, and preserves the index values of known Ethernet interfaces. If you add an interface, **udev** assigns an index value that is one greater than the previously-assigned index value to the new interface.

### Prerequisites

- The prefix consists of ASCII characters.
- The prefix is an alphanumeric string.
- The prefix is shorter than 16 characters.
- The prefix does not conflict with any other well-known network interface prefix, such as **eth**, **eno**, **ens**, and **em**.

### Procedure

1. Boot the Red Hat Enterprise Linux installation media.

2. In the boot manager, follow these steps:
  - a. Select the **Install Red Hat Enterprise Linux <version>** entry.
  - b. Press **Tab** to edit the entry.
  - c. Append **net.ifnames.prefix=<prefix>** to the kernel options.
  - d. Press **Enter** to start the installation program.
3. Install Red Hat Enterprise Linux.

## Verification

- To verify the interface names, display the network interfaces:

```
# ip link show
...
2: net0: <BROADCAST,MULTICAST,UP,LOWER_UP> mtu 1500 qdisc fq_codel state UP
mode DEFAULT group default qlen 1000
   link/ether 00:00:5e:00:53:1a brd ff:ff:ff:ff:ff:ff
...
```

## Additional resources

- [Performing a standard RHEL 8 installation](#)

## 1.6. CONFIGURING USER-DEFINED NETWORK INTERFACE NAMES BY USING UDEV RULES

You can use **udev** rules to implement custom network interface names that reflect your organization's requirements.

### Procedure

1. Identify the network interface that you want to rename:

```
# ip link show
...
enp1s0: <BROADCAST,MULTICAST,UP,LOWER_UP> mtu 1500 qdisc fq_codel state UP
mode DEFAULT group default qlen 1000
   link/ether 00:00:5e:00:53:1a brd ff:ff:ff:ff:ff:ff
...
```

Record the MAC address of the interface.

2. Display the device type ID of the interface:

```
# cat /sys/class/net/enp1s0/type
1
```

3. Create the **/etc/udev/rules.d/70-persistent-net.rules** file, and add a rule for each interface that you want to rename:

```
SUBSYSTEM=="net",ACTION=="add",ATTR{address}=="<MAC_address>",ATTR{type}
=="<device_type_id>",NAME="<new_interface_name>"
```



## IMPORTANT

Use only **70-persistent-net.rules** as a file name if you require consistent device names during the boot process. The **dracut** utility adds a file with this name to the **initrd** image if you regenerate the RAM disk image.

For example, use the following rule to rename the interface with MAC address **00:00:5e:00:53:1a** to **provider0**:

```
SUBSYSTEM=="net",ACTION=="add",ATTR{address}=="00:00:5e:00:53:1a",ATTR{type}
=="1",NAME="provider0"
```

- Optional: Regenerate the **initrd** RAM disk image:

```
# dracut -f
```

You require this step only if you need networking capabilities in the RAM disk. For example, this is the case if the root file system is stored on a network device, such as iSCSI.

- Identify which NetworkManager connection profile uses the interface that you want to rename:

```
# nmcli -f device,name connection show
DEVICE NAME
enp1s0 example_profile
...
```

- Unset the **connection.interface-name** property in the connection profile:

```
# nmcli connection modify example_profile connection.interface-name ""
```

- Temporarily, configure the connection profile to match both the new and the previous interface name:

```
# nmcli connection modify example_profile match.interface-name "provider0 enp1s0"
```

- Reboot the system:

```
# reboot
```

- Verify that the device with the MAC address that you specified in the link file has been renamed to **provider0**:

```
# ip link show
provider0: <BROADCAST,MULTICAST,UP,LOWER_UP> mtu 1500 qdisc mq state UP mode
DEFAULT group default qlen 1000
    link/ether 00:00:5e:00:53:1a brd ff:ff:ff:ff:ff:ff
...
```

- Configure the connection profile to match only the new interface name:

```
# nmcli connection modify example_profile match.interface-name "provider0"
```

You have now removed the old interface name from the connection profile.

11. Reactivate the connection profile:

```
# nmcli connection up example_profile
```

### Additional resources

- [udev\(7\)](#) man page

## 1.7. CONFIGURING USER-DEFINED NETWORK INTERFACE NAMES BY USING SYSTEMD LINK FILES

You can use **systemd** link files to implement custom network interface names that reflect your organization's requirements.

### Prerequisites

- You must meet one of these conditions: NetworkManager does not manage this interface, or the corresponding connection profile uses the [keyfile format](#).

### Procedure

1. Identify the network interface that you want to rename:

```
# ip link show
...
enp1s0: <BROADCAST,MULTICAST,UP,LOWER_UP> mtu 1500 qdisc fq_codel state UP
mode DEFAULT group default qlen 1000
    link/ether 00:00:5e:00:53:1a brd ff:ff:ff:ff:ff:ff
...
```

Record the MAC address of the interface.

2. If it does not already exist, create the `/etc/systemd/network/` directory:

```
# mkdir -p /etc/systemd/network/
```

3. For each interface that you want to rename, create a `70-*.link` file in the `/etc/systemd/network/` directory with the following content:

```
[Match]
MACAddress=<MAC_address>

[Link]
Name=<new_interface_name>
```



**IMPORTANT**

Use a file name with a **70-** prefix to keep the file names consistent with the **udev** rules-based solution.

For example, create the `/etc/systemd/network/70-provider0.link` file with the following content to rename the interface with MAC address `00:00:5e:00:53:1a` to **provider0**:

```
[Match]
MACAddress=00:00:5e:00:53:1a

[Link]
Name=provider0
```

- Optional: Regenerate the **initrd** RAM disk image:

```
# dracut -f
```

You require this step only if you need networking capabilities in the RAM disk. For example, this is the case if the root file system is stored on a network device, such as iSCSI.

- Identify which NetworkManager connection profile uses the interface that you want to rename:

```
# nmcli -f device,name connection show
DEVICE NAME
enp1s0 example_profile
...
```

- Unset the **connection.interface-name** property in the connection profile:

```
# nmcli connection modify example_profile connection.interface-name ""
```

- Temporarily, configure the connection profile to match both the new and the previous interface name:

```
# nmcli connection modify example_profile match.interface-name "provider0 enp1s0"
```

- Reboot the system:

```
# reboot
```

- Verify that the device with the MAC address that you specified in the link file has been renamed to **provider0**:

```
# ip link show
provider0: <BROADCAST,MULTICAST,UP,LOWER_UP> mtu 1500 qdisc mq state UP mode
DEFAULT group default qlen 1000
    link/ether 00:00:5e:00:53:1a brd ff:ff:ff:ff:ff:ff
...
```

- Configure the connection profile to match only the new interface name:

```
# nmcli connection modify example_profile match.interface-name "provider0"
```

-

You have now removed the old interface name from the connection profile.

11. Reactivate the connection profile.

```
# nmcli connection up example_profile
```

### Additional resources

- [systemd.link\(5\)](#) man page

## 1.8. ASSIGNING ALTERNATIVE NAMES TO A NETWORK INTERFACE BY USING SYSTEMD LINK FILES

With alternative interface naming, the kernel can assign additional names to network interfaces. You can use these alternative names in the same way as the normal interface names in commands that require a network interface name.

### Prerequisites

- You must use ASCII characters for the alternative name.
- The alternative name must be shorter than 128 characters.

### Procedure

1. Display the network interface names and their MAC addresses:

```
# ip link show
...
enp1s0: <BROADCAST,MULTICAST,UP,LOWER_UP> mtu 1500 qdisc fq_codel state UP
mode DEFAULT group default qlen 1000
    link/ether 00:00:5e:00:53:1a brd ff:ff:ff:ff:ff:ff
...
```

Record the MAC address of the interface to which you want to assign an alternative name.

2. If it does not already exist, create the `/etc/systemd/network/` directory:

```
# mkdir -p /etc/systemd/network/
```

3. For each interface that must have an alternative name, create a `*.link` file in the `/etc/systemd/network/` directory with the following content:

```
[Match]
MACAddress=<MAC_address>

[Link]
AlternativeName=<alternative_interface_name_1>
AlternativeName=<alternative_interface_name_2>
AlternativeName=<alternative_interface_name_n>
```

For example, create the `/etc/systemd/network/70-altname.link` file with the following content to assign **provider** as an alternative name to the interface with MAC address **00:00:5e:00:53:1a**:

```
[Match]
MACAddress=00:00:5e:00:53:1a

[Link]
AlternativeName=provider
```

4. Regenerate the **initrd** RAM disk image:

```
# dracut -f
```

5. Reboot the system:

```
# reboot
```

### Verification

- Use the alternative interface name. For example, display the IP address settings of the device with the alternative name **provider**:

```
# ip address show provider
2: enp1s0: <BROADCAST,MULTICAST,UP,LOWER_UP> mtu 1500 qdisc fq_codel state UP
group default qlen 1000
    link/ether 00:00:5e:00:53:1a brd ff:ff:ff:ff:ff:ff
    altname provider
    ...
```

### Additional resources

- [What is AlternativeNamesPolicy in Interface naming scheme?](#)

## CHAPTER 2. CONFIGURING AN ETHERNET CONNECTION

NetworkManager creates a connection profile for each Ethernet adapter that is installed in a host. By default, this profile uses DHCP for both IPv4 and IPv6 connections. Modify this automatically-created profile or add a new one in the following cases:

- The network requires custom settings, such as a static IP address configuration.
- You require multiple profiles because the host roams among different networks.

Red Hat Enterprise Linux provides administrators different options to configure Ethernet connections. For example:

- Use **nmcli** to configure connections on the command line.
- Use **nmtui** to configure connections in a text-based user interface.
- Use the GNOME Settings menu or **nm-connection-editor** application to configure connections in a graphical interface.
- Use **nmstatectl** to configure connections through the Nmstate API.
- Use RHEL system roles to automate the configuration of connections on one or multiple hosts.



### NOTE

If you want to manually configure Ethernet connections on hosts running in the Microsoft Azure cloud, disable the **cloud-init** service or configure it to ignore the network settings retrieved from the cloud environment. Otherwise, **cloud-init** will override on the next reboot the network settings that you have manually configured.

## 2.1. CONFIGURING AN ETHERNET CONNECTION BY USING NMCLI

If you connect a host to the network over Ethernet, you can manage the connection's settings on the command line by using the **nmcli** utility.

### Prerequisites

- A physical or virtual Ethernet Network Interface Controller (NIC) exists in the server's configuration.

### Procedure

1. List the NetworkManager connection profiles:

```
# nmcli connection show
NAME                UUID                                TYPE  DEVICE
Wired connection 1  a5eb6490-cc20-3668-81f8-0314a27f3f75  ethernet  enp1s0
```

By default, NetworkManager creates a profile for each NIC in the host. If you plan to connect this NIC only to a specific network, adapt the automatically-created profile. If you plan to connect this NIC to networks with different settings, create individual profiles for each network.

2. If you want to create an additional connection profile, enter:

```
# nmcli connection add con-name <connection-name> ifname <device-name> type ethernet
```

Skip this step to modify an existing profile.

- Optional: Rename the connection profile:

```
# nmcli connection modify "Wired connection 1" connection.id "Internal-LAN"
```

On hosts with multiple profiles, a meaningful name makes it easier to identify the purpose of a profile.

- Display the current settings of the connection profile:

```
# nmcli connection show Internal-LAN
...
connection.interface-name: enp1s0
connection.autoconnect:   yes
ipv4.method:               auto
ipv6.method:               auto
...
```

- Configure the IPv4 settings:

- To use DHCP, enter:

```
# nmcli connection modify Internal-LAN ipv4.method auto
```

Skip this step if **ipv4.method** is already set to **auto** (default).

- To set a static IPv4 address, network mask, default gateway, DNS servers, and search domain, enter:

```
# nmcli connection modify Internal-LAN ipv4.method manual ipv4.addresses 192.0.2.1/24 ipv4.gateway 192.0.2.254 ipv4.dns 192.0.2.200 ipv4.dns-search example.com
```

- Configure the IPv6 settings:

- To use stateless address autoconfiguration (SLAAC), enter:

```
# nmcli connection modify Internal-LAN ipv6.method auto
```

Skip this step if **ipv6.method** is already set to **auto** (default).

- To set a static IPv6 address, network mask, default gateway, DNS servers, and search domain, enter:

```
# nmcli connection modify Internal-LAN ipv6.method manual ipv6.addresses 2001:db8:1::fffe/64 ipv6.gateway 2001:db8:1::fffe ipv6.dns 2001:db8:1::ffbb ipv6.dns-search example.com
```

- To customize other settings in the profile, use the following command:

```
# nmcli connection modify <connection-name> <setting> <value>
```

Enclose values with spaces or semicolons in quotes.

8. Activate the profile:

```
# nmcli connection up Internal-LAN
```

## Verification

1. Display the IP settings of the NIC:

```
# ip address show enp1s0
2: enp1s0: <BROADCAST,MULTICAST,UP,LOWER_UP> mtu 1500 qdisc fq_codel state UP
group default qlen 1000
    link/ether 52:54:00:17:b8:b6 brd ff:ff:ff:ff:ff:ff
    inet 192.0.2.1/24 brd 192.0.2.255 scope global noprefixroute enp1s0
        valid_lft forever preferred_lft forever
    inet6 2001:db8:1::ffe/64 scope global noprefixroute
        valid_lft forever preferred_lft forever
```

2. Display the IPv4 default gateway:

```
# ip route show default
default via 192.0.2.254 dev enp1s0 proto static metric 102
```

3. Display the IPv6 default gateway:

```
# ip -6 route show default
default via 2001:db8:1::fee dev enp1s0 proto static metric 102 pref medium
```

4. Display the DNS settings:

```
# cat /etc/resolv.conf
search example.com
nameserver 192.0.2.200
nameserver 2001:db8:1::ffbb
```

If multiple connection profiles are active at the same time, the order of **nameserver** entries depend on the DNS priority values in these profile and the connection types.

5. Use the **ping** utility to verify that this host can send packets to other hosts:

```
# ping <host-name-or-IP-address>
```

## Troubleshooting

- Verify that the network cable is plugged-in to the host and a switch.
- Check whether the link failure exists only on this host or also on other hosts connected to the same switch.

- Verify that the network cable and the network interface are working as expected. Perform hardware diagnosis steps and replace defect cables and network interface cards.
- If the configuration on the disk does not match the configuration on the device, starting or restarting NetworkManager creates an in-memory connection that reflects the configuration of the device. For further details and how to avoid this problem, see the [NetworkManager duplicates a connection after restart of NetworkManager service](#) solution.

### Additional resources

- [nm-settings\(5\)](#) man page
- [Configuring NetworkManager to avoid using a specific profile to provide a default gateway](#)
- [Configuring the order of DNS servers](#)

## 2.2. CONFIGURING AN ETHERNET CONNECTION BY USING THE NMCLI INTERACTIVE EDITOR

If you connect a host to the network over Ethernet, you can manage the connection's settings on the command line by using the **nmcli** utility.

### Prerequisites

- A physical or virtual Ethernet Network Interface Controller (NIC) exists in the server's configuration.

### Procedure

1. List the NetworkManager connection profiles:

```
# nmcli connection show
NAME                UUID                                TYPE  DEVICE
Wired connection 1  a5eb6490-cc20-3668-81f8-0314a27f3f75  ethernet  enp1s0
```

By default, NetworkManager creates a profile for each NIC in the host. If you plan to connect this NIC only to a specific network, adapt the automatically-created profile. If you plan to connect this NIC to networks with different settings, create individual profiles for each network.

2. Start **nmcli** in interactive mode:

- To create an additional connection profile, enter:

```
# nmcli connection edit type ethernet con-name "<connection-name>"
```

- To modify an existing connection profile, enter:

```
# nmcli connection edit con-name "<connection-name>"
```

3. Optional: Rename the connection profile:

```
nmcli> set connection.id Internal-LAN
```

On hosts with multiple profiles, a meaningful name makes it easier to identify the purpose of a profile.

Do not use quotes to set an ID that contains spaces to avoid that **nmcli** makes the quotes part of the name. For example, to set **Example Connection** as ID, enter **set connection.id Example Connection**.

4. Display the current settings of the connection profile:

```
nmcli> print
...
connection.interface-name:  enp1s0
connection.autoconnect:    yes
ipv4.method:                auto
ipv6.method:                auto
...
```

5. If you create a new connection profile, set the network interface:

```
nmcli> set connection.interface-name enp1s0
```

6. Configure the IPv4 settings:

- To use DHCP, enter:

```
nmcli> set ipv4.method auto
```

Skip this step if **ipv4.method** is already set to **auto** (default).

- To set a static IPv4 address, network mask, default gateway, DNS servers, and search domain, enter:

```
nmcli> ipv4.addresses 192.0.2.1/24
Do you also want to set 'ipv4.method' to 'manual'? [yes]: yes
nmcli> ipv4.gateway 192.0.2.254
nmcli> ipv4.dns 192.0.2.200
nmcli> ipv4.dns-search example.com
```

7. Configure the IPv6 settings:

- To use stateless address autoconfiguration (SLAAC), enter:

```
nmcli> set ipv6.method auto
```

Skip this step if **ipv6.method** is already set to **auto** (default).

- To set a static IPv6 address, network mask, default gateway, DNS servers, and search domain, enter:

```
nmcli> ipv6.addresses 2001:db8:1::ffe/64
Do you also want to set 'ipv6.method' to 'manual'? [yes]: yes
nmcli> ipv6.gateway 2001:db8:1::ffe
nmcli> ipv6.dns 2001:db8:1::ffbb
nmcli> ipv6.dns-search example.com
```



8. Save and activate the connection:

```
nmcli> save persistent
```

9. Leave the interactive mode:

```
nmcli> quit
```

## Verification

1. Display the IP settings of the NIC:

```
# ip address show enp1s0
2: enp1s0: <BROADCAST,MULTICAST,UP,LOWER_UP> mtu 1500 qdisc fq_codel state UP
group default qlen 1000
    link/ether 52:54:00:17:b8:b6 brd ff:ff:ff:ff:ff:ff
    inet 192.0.2.1/24 brd 192.0.2.255 scope global noprefixroute enp1s0
        valid_lft forever preferred_lft forever
    inet6 2001:db8:1::ffe/64 scope global noprefixroute
        valid_lft forever preferred_lft forever
```

2. Display the IPv4 default gateway:

```
# ip route show default
default via 192.0.2.254 dev enp1s0 proto static metric 102
```

3. Display the IPv6 default gateway:

```
# ip -6 route show default
default via 2001:db8:1::fee dev enp1s0 proto static metric 102 pref medium
```

4. Display the DNS settings:

```
# cat /etc/resolv.conf
search example.com
nameserver 192.0.2.200
nameserver 2001:db8:1::ffbb
```

If multiple connection profiles are active at the same time, the order of **nameserver** entries depend on the DNS priority values in these profile and the connection types.

5. Use the **ping** utility to verify that this host can send packets to other hosts:

```
# ping <host-name-or-IP-address>
```

## Troubleshooting

- Verify that the network cable is plugged-in to the host and a switch.
- Check whether the link failure exists only on this host or also on other hosts connected to the same switch.

- Verify that the network cable and the network interface are working as expected. Perform hardware diagnosis steps and replace defect cables and network interface cards.
- If the configuration on the disk does not match the configuration on the device, starting or restarting NetworkManager creates an in-memory connection that reflects the configuration of the device. For further details and how to avoid this problem, see the [NetworkManager duplicates a connection after restart of NetworkManager service](#) solution

### Additional resources

- [nm-settings\(5\)](#) man page
- [nmcli\(1\)](#) man page
- [Configuring NetworkManager to avoid using a specific profile to provide a default gateway](#)
- [Configuring the order of DNS servers](#)

## 2.3. CONFIGURING AN ETHERNET CONNECTION BY USING NMTUI

If you connect a host to the network over Ethernet, you can manage the connection's settings in a text-based user interface by using the `nmtui` application. Use `nmtui` to create new profiles and to update existing ones on a host without a graphical interface.

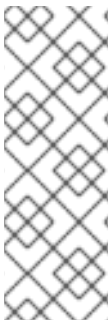

### NOTE

In `nmtui`:

- Navigate by using the cursor keys.
- Press a button by selecting it and hitting **Enter**.
- Select and deselect checkboxes by using **Space**.

### Prerequisites

- A physical or virtual Ethernet Network Interface Controller (NIC) exists in the server's configuration.

### Procedure

1. If you do not know the network device name you want to use in the connection, display the available devices:

```
# nmcli device status
DEVICE  TYPE    STATE      CONNECTION
enp1s0  ethernet unavailable --
...
```

2. Start `nmtui`:

```
# nmtui
```

3. Select **Edit a connection**, and press **Enter**.

4. Choose whether to add a new connection profile or to modify an existing one:
  - To create a new profile:
    - i. Press the **Add** button.
    - ii. Select **Ethernet** from the list of network types, and press **Enter**.
  - To modify an existing profile, select the profile from the list, and press **Enter**.
5. Optional: Update the name of the connection profile.

On hosts with multiple profiles, a meaningful name makes it easier to identify the purpose of a profile.
6. If you create a new connection profile, enter the network device name into the **Device** field.
7. Depending on your environment, configure the IP address settings in the **IPv4 configuration** and **IPv6 configuration** areas accordingly. For this, press the button next to these areas, and select:
  - **Disabled**, if this connection does not require an IP address.
  - **Automatic**, if a DHCP server dynamically assigns an IP address to this NIC.
  - **Manual**, if the network requires static IP address settings. In this case, you must fill further fields:
    - i. Press the **Show** button next to the protocol you want to configure to display additional fields.
    - ii. Press the **Add** button next to **Addresses**, and enter the IP address and the subnet mask in Classless Inter-Domain Routing (CIDR) format.

If you do not specify a subnet mask, NetworkManager sets a **/32** subnet mask for IPv4 addresses and **/64** for IPv6 addresses.
    - iii. Enter the address of the default gateway.
    - iv. Press the **Add** button next to **DNS servers**, and enter the DNS server address.
    - v. Press the **Add** button next to **Search domains**, and enter the DNS search domain.

Figure 2.1. Example of an Ethernet connection with static IP address settings

Edit Connection

Profile name `Example-Connection`  
 Device `enp7s0`

= ETHERNET <Show>

IPv4 CONFIGURATION `<Manual>` <Hide>

Addresses `192.0.2.1/24` <Remove>  
<Add...>

Gateway `192.0.2.254`

DNS servers `192.0.2.200` <Remove>  
<Add...>

Search domains `example.com` <Remove>  
<Add...>

Routing (No custom routes) <Edit...>

Never use this network for default route  
 Ignore automatically obtained routes  
 Ignore automatically obtained DNS parameters

Require IPv4 addressing for this connection

IPv6 CONFIGURATION `<Manual>` <Hide>

Addresses `2001:db8:1::1/64` <Remove>  
<Add...>

Gateway `2001:db8:1::fffe`

DNS servers `2001:db8:1::ffbb` <Remove>  
<Add...>

Search domains `example.com` <Remove>  
<Add...>

Routing (No custom routes) <Edit...>

Never use this network for default route  
 Ignore automatically obtained routes  
 Ignore automatically obtained DNS parameters

Require IPv6 addressing for this connection

Automatically connect  
 Available to all users

<Cancel> <OK>

8. Press the **OK** button to create and automatically activate the new connection.
9. Press the **Back** button to return to the main menu.
10. Select **Quit**, and press **Enter** to close the **nmtui** application.

## Verification

1. Display the IP settings of the NIC:

```
# ip address show enp1s0
```

```
2: enp1s0: <BROADCAST,MULTICAST,UP,LOWER_UP> mtu 1500 qdisc fq_codel state UP
group default qlen 1000
link/ether 52:54:00:17:b8:b6 brd ff:ff:ff:ff:ff:ff
```

```
inet 192.0.2.1/24 brd 192.0.2.255 scope global noprefixroute enp1s0
    valid_lft forever preferred_lft forever
inet6 2001:db8:1::fffe/64 scope global noprefixroute
    valid_lft forever preferred_lft forever
```

2. Display the IPv4 default gateway:

```
# ip route show default
default via 192.0.2.254 dev enp1s0 proto static metric 102
```

3. Display the IPv6 default gateway:

```
# ip -6 route show default
default via 2001:db8:1::ffee dev enp1s0 proto static metric 102 pref medium
```

4. Display the DNS settings:

```
# cat /etc/resolv.conf
search example.com
nameserver 192.0.2.200
nameserver 2001:db8:1::ffbb
```

If multiple connection profiles are active at the same time, the order of **nameserver** entries depend on the DNS priority values in these profile and the connection types.

5. Use the **ping** utility to verify that this host can send packets to other hosts:

```
# ping <host-name-or-IP-address>
```

## Troubleshooting

- Verify that the network cable is plugged-in to the host and a switch.
- Check whether the link failure exists only on this host or also on other hosts connected to the same switch.
- Verify that the network cable and the network interface are working as expected. Perform hardware diagnosis steps and replace defect cables and network interface cards.
- If the configuration on the disk does not match the configuration on the device, starting or restarting NetworkManager creates an in-memory connection that reflects the configuration of the device. For further details and how to avoid this problem, see the [NetworkManager duplicates a connection after restart of NetworkManager service](#) solution.

## Additional resources

- [Configuring NetworkManager to avoid using a specific profile to provide a default gateway](#)
- [Configuring the order of DNS servers](#)

## 2.4. CONFIGURING AN ETHERNET CONNECTION BY USING CONTROL-CENTER

If you connect a host to the network over Ethernet, you can manage the connection's settings with a graphical interface by using the GNOME Settings menu.

Note that **control-center** does not support as many configuration options as the **nm-connection-editor** application or the **nmcli** utility.

## Prerequisites

- A physical or virtual Ethernet Network Interface Controller (NIC) exists in the server's configuration.
- GNOME is installed.

## Procedure

1. Press the **Super** key, enter **Settings**, and press **Enter**.
2. Select **Network** in the navigation on the left.
3. Choose whether to add a new connection profile or to modify an existing one:
  - To create a new profile, click the **+** button next to the **Ethernet** entry.
  - To modify an existing profile, click the gear icon next to the profile entry.
4. Optional: On the **Identity** tab, update the name of the connection profile.  
On hosts with multiple profiles, a meaningful name makes it easier to identify the purpose of a profile.
5. Depending on your environment, configure the IP address settings on the **IPv4** and **IPv6** tabs accordingly:
  - To use DHCP or IPv6 stateless address autoconfiguration (SLAAC), select **Automatic (DHCP)** as method (default).
  - To set a static IP address, network mask, default gateway, DNS servers, and search domain, select **Manual** as method, and fill the fields on the tabs:

The image shows two side-by-side screenshots of the 'New Profile' dialog box in the GNOME Settings application. Both screenshots have 'Cancel' and 'Add' buttons at the top.

The left screenshot is the **IPv4** tab. Under 'IPv4 Method', the 'Manual' radio button is selected. Below, the 'Addresses' section has three input fields: 'Address' (192.0.2.1), 'Netmask' (24), and 'Gateway' (192.0.2.254). The 'DNS' section has one input field (192.0.2.1) and an 'Automatic' toggle set to 'ON'. A note at the bottom says 'Separate IP addresses with commas'.

The right screenshot is the **IPv6** tab. Under 'IPv6 Method', the 'Manual' radio button is selected. Below, the 'Addresses' section has three input fields: 'Address' (2001:db8:1::1), 'Prefix' (64), and 'Gateway' (2001:db8:1::fff3). The 'DNS' section has one input field (2001:db8:1::fffd) and an 'Automatic' toggle set to 'ON'.

6. Depending on whether you add or modify a connection profile, click the **Add** or **Apply** button to save the connection.  
The GNOME **control-center** automatically activates the connection.

## Verification

1. Display the IP settings of the NIC:

```
# ip address show enp1s0
2: enp1s0: <BROADCAST,MULTICAST,UP,LOWER_UP> mtu 1500 qdisc fq_codel state UP
group default qlen 1000
    link/ether 52:54:00:17:b8:b6 brd ff:ff:ff:ff:ff:ff
    inet 192.0.2.1/24 brd 192.0.2.255 scope global noprefixroute enp1s0
        valid_lft forever preferred_lft forever
    inet6 2001:db8:1::ffe/64 scope global noprefixroute
        valid_lft forever preferred_lft forever
```

2. Display the IPv4 default gateway:

```
# ip route show default
default via 192.0.2.254 dev enp1s0 proto static metric 102
```

3. Display the IPv6 default gateway:

```
# ip -6 route show default
default via 2001:db8:1::fee dev enp1s0 proto static metric 102 pref medium
```

4. Display the DNS settings:

```
# cat /etc/resolv.conf
search example.com
nameserver 192.0.2.200
nameserver 2001:db8:1::ffbb
```

If multiple connection profiles are active at the same time, the order of **nameserver** entries depend on the DNS priority values in these profile and the connection types.

5. Use the **ping** utility to verify that this host can send packets to other hosts:

```
# ping <host-name-or-IP-address>
```

### Troubleshooting steps

- Verify that the network cable is plugged-in to the host and a switch.
- Check whether the link failure exists only on this host or also on other hosts connected to the same switch.
- Verify that the network cable and the network interface are working as expected. Perform hardware diagnosis steps and replace defect cables and network interface cards.
- If the configuration on the disk does not match the configuration on the device, starting or restarting NetworkManager creates an in-memory connection that reflects the configuration of the device. For further details and how to avoid this problem, see the [NetworkManager duplicates a connection after restart of NetworkManager service](#) solution.

### Additional Resources

- [Configuring NetworkManager to avoid using a specific profile to provide a default gateway](#)

- [Configuring the order of DNS servers](#)

## 2.5. CONFIGURING AN ETHERNET CONNECTION BY USING NM-CONNECTION-EDITOR

If you connect a host to the network over Ethernet, you can manage the connection's settings with a graphical interface by using the `nm-connection-editor` application.

### Prerequisites

- A physical or virtual Ethernet Network Interface Controller (NIC) exists in the server's configuration.
- GNOME is installed.

### Procedure

1. Open a terminal, and enter:

```
$ nm-connection-editor
```

2. Choose whether to add a new connection profile or to modify an existing one:

- To create a new profile:
  - i. Click the **+** button
  - ii. Select **Ethernet** as connection type, and click **Create**.
- To modify an existing profile, double-click the profile entry.

3. Optional: Update the name of the profile in the **Connection Name** field.

On hosts with multiple profiles, a meaningful name makes it easier to identify the purpose of a profile.

4. If you create a new profile, select the device on the **Ethernet** tab:

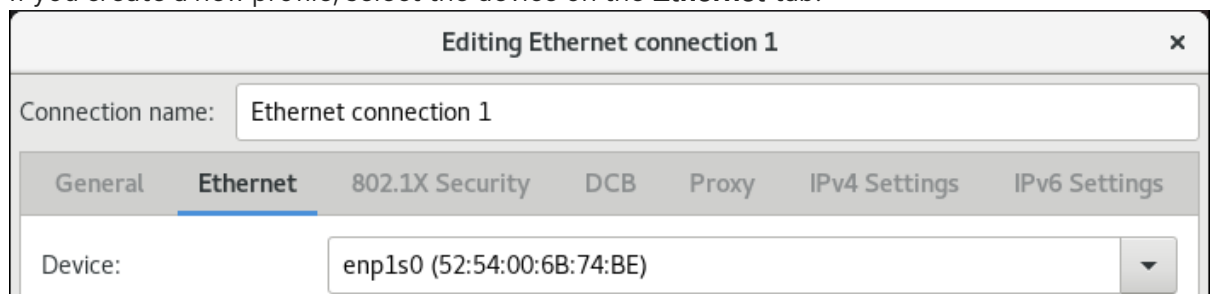

5. Depending on your environment, configure the IP address settings on the **IPv4 Settings** and **IPv6 Settings** tabs accordingly:

- To use DHCP or IPv6 stateless address autoconfiguration (SLAAC), select **Automatic (DHCP)** as method (default).
- To set a static IP address, network mask, default gateway, DNS servers, and search domain, select **Manual** as method, and fill the fields on the tabs:



6. Click **Save**.
7. Close `nm-connection-editor`.

## Verification

1. Display the IP settings of the NIC:

```
# ip address show enp1s0
2: enp1s0: <BROADCAST,MULTICAST,UP,LOWER_UP> mtu 1500 qdisc fq_codel state UP
group default qlen 1000
link/ether 52:54:00:17:b8:b6 brd ff:ff:ff:ff:ff:ff
inet 192.0.2.1/24 brd 192.0.2.255 scope global noprefixroute enp1s0
    valid_lft forever preferred_lft forever
inet6 2001:db8:1::ffe/64 scope global noprefixroute
    valid_lft forever preferred_lft forever
```

2. Display the IPv4 default gateway:

```
# ip route show default
default via 192.0.2.254 dev enp1s0 proto static metric 102
```

3. Display the IPv6 default gateway:

```
# ip -6 route show default
default via 2001:db8:1::fee dev enp1s0 proto static metric 102 pref medium
```

4. Display the DNS settings:

```
# cat /etc/resolv.conf
search example.com
nameserver 192.0.2.200
nameserver 2001:db8:1::ffbb
```

If multiple connection profiles are active at the same time, the order of **nameserver** entries depend on the DNS priority values in these profile and the connection types.

5. Use the **ping** utility to verify that this host can send packets to other hosts:

```
# ping <host-name-or-IP-address>
```

## Troubleshooting steps

- Verify that the network cable is plugged-in to the host and a switch.

- Check whether the link failure exists only on this host or also on other hosts connected to the same switch.
- Verify that the network cable and the network interface are working as expected. Perform hardware diagnosis steps and replace defect cables and network interface cards.
- If the configuration on the disk does not match the configuration on the device, starting or restarting NetworkManager creates an in-memory connection that reflects the configuration of the device. For further details and how to avoid this problem, see the [NetworkManager duplicates a connection after restart of NetworkManager service](#) solution.

### Additional Resources

- [Configuring NetworkManager to avoid using a specific profile to provide a default gateway](#)
- [Configuring the order of DNS servers](#)

## 2.6. CONFIGURING AN ETHERNET CONNECTION WITH A STATIC IP ADDRESS BY USING NMSTATECTL

Use the **nmstatectl** utility to configure an Ethernet connection through the Nmstate API. The Nmstate API ensures that, after setting the configuration, the result matches the configuration file. If anything fails, **nmstatectl** automatically rolls back the changes to avoid leaving the system in an incorrect state.

### Prerequisites

- A physical or virtual Ethernet Network Interface Controller (NIC) exists in the server's configuration.
- The **nmstate** package is installed.

### Procedure

1. Create a YAML file, for example `~/create-ethernet-profile.yml`, with the following content:

```
---
interfaces:
- name: enp1s0
  type: ethernet
  state: up
  ipv4:
    enabled: true
    address:
    - ip: 192.0.2.1
      prefix-length: 24
    dhcp: false
  ipv6:
    enabled: true
    address:
    - ip: 2001:db8:1::1
      prefix-length: 64
    autoconf: false
    dhcp: false
routes:
  config:
```

```

- destination: 0.0.0.0/0
  next-hop-address: 192.0.2.254
  next-hop-interface: enp1s0
- destination: ::0
  next-hop-address: 2001:db8:1::fffe
  next-hop-interface: enp1s0
dns-resolver:
config:
  search:
  - example.com
  server:
  - 192.0.2.200
  - 2001:db8:1::ffbb

```

These settings define an Ethernet connection profile for the **enp1s0** device with the following settings:

- A static IPv4 address - **192.0.2.1** with the **/24** subnet mask
- A static IPv6 address - **2001:db8:1::1** with the **/64** subnet mask
- An IPv4 default gateway - **192.0.2.254**
- An IPv6 default gateway - **2001:db8:1::fffe**
- An IPv4 DNS server - **192.0.2.200**
- An IPv6 DNS server - **2001:db8:1::ffbb**
- A DNS search domain - **example.com**

2. Apply the settings to the system:

```
# nmstatectl apply ~/create-ethernet-profile.yml
```

## Verification

1. Display the current state in YAML format:

```
# nmstatectl show enp1s0
```

2. Display the IP settings of the NIC:

```

# ip address show enp1s0
2: enp1s0: <BROADCAST,MULTICAST,UP,LOWER_UP> mtu 1500 qdisc fq_codel state UP
group default qlen 1000
  link/ether 52:54:00:17:b8:b6 brd ff:ff:ff:ff:ff:ff
  inet 192.0.2.1/24 brd 192.0.2.255 scope global noprefixroute enp1s0
    valid_lft forever preferred_lft forever
  inet6 2001:db8:1::fffe/64 scope global noprefixroute
    valid_lft forever preferred_lft forever

```

3. Display the IPv4 default gateway:

```
# ip route show default
default via 192.0.2.254 dev enp1s0 proto static metric 102
```

4. Display the IPv6 default gateway:

```
# ip -6 route show default
default via 2001:db8:1::ffee dev enp1s0 proto static metric 102 pref medium
```

5. Display the DNS settings:

```
# cat /etc/resolv.conf
search example.com
nameserver 192.0.2.200
nameserver 2001:db8:1::ffbb
```

If multiple connection profiles are active at the same time, the order of **nameserver** entries depend on the DNS priority values in these profile and the connection types.

6. Use the **ping** utility to verify that this host can send packets to other hosts:

```
# ping <host-name-or-IP-address>
```

#### Additional resources

- **nmstatectl(8)** man page
- `/usr/share/doc/nmstate/examples/` directory

## 2.7. CONFIGURING AN ETHERNET CONNECTION WITH A STATIC IP ADDRESS BY USING THE NETWORK RHEL SYSTEM ROLE WITH AN INTERFACE NAME

You can remotely configure an Ethernet connection by using the **network** RHEL system role.

#### Prerequisites

- [You have prepared the control node and the managed nodes](#)
- You are logged in to the control node as a user who can run playbooks on the managed nodes.
- The account you use to connect to the managed nodes has **sudo** permissions on them.
- A physical or virtual Ethernet device exists in the server's configuration.
- The managed nodes use NetworkManager to configure the network.

#### Procedure

1. Create a playbook file, for example `~/playbook.yml`, with the following content:

```
---
- name: Configure the network
  hosts: managed-node-01.example.com
```

```

tasks:
- name: Configure an Ethernet connection with static IP
  ansible.builtin.include_role:
    name: rhel-system-roles.network
  vars:
    network_connections:
    - name: enp1s0
      interface_name: enp1s0
      type: ethernet
      autoconnect: yes
      ip:
        address:
        - 192.0.2.1/24
        - 2001:db8:1::1/64
      gateway4: 192.0.2.254
      gateway6: 2001:db8:1::ffe
      dns:
        - 192.0.2.200
        - 2001:db8:1::ffbb
      dns_search:
        - example.com
      state: up

```

These settings define an Ethernet connection profile for the **enp1s0** device with the following settings:

- A static IPv4 address - **192.0.2.1** with a **/24** subnet mask
- A static IPv6 address - **2001:db8:1::1** with a **/64** subnet mask
- An IPv4 default gateway - **192.0.2.254**
- An IPv6 default gateway - **2001:db8:1::ffe**
- An IPv4 DNS server - **192.0.2.200**
- An IPv6 DNS server - **2001:db8:1::ffbb**
- A DNS search domain - **example.com**

2. Validate the playbook syntax:

```
$ ansible-playbook --syntax-check ~/playbook.yml
```

Note that this command only validates the syntax and does not protect against a wrong but valid configuration.

3. Run the playbook:

```
$ ansible-playbook ~/playbook.yml
```

### Additional resources

- `/usr/share/ansible/roles/rhel-system-roles.network/README.md` file
- `/usr/share/doc/rhel-system-roles/network/` directory

## 2.8. CONFIGURING AN ETHERNET CONNECTION WITH A STATIC IP ADDRESS BY USING THE NETWORK RHEL SYSTEM ROLE WITH A DEVICE PATH

You can remotely configure an Ethernet connection using the **network** RHEL system role.

You can identify the device path with the following command:

```
# udevadm info /sys/class/net/<device_name> | grep ID_PATH=
```

### Prerequisites

- You have prepared the control node and the managed nodes
- You are logged in to the control node as a user who can run playbooks on the managed nodes.
- The account you use to connect to the managed nodes has **sudo** permissions on them.
- A physical or virtual Ethernet device exists in the server's configuration.
- The managed nodes use NetworkManager to configure the network.

### Procedure

1. Create a playbook file, for example `~/playbook.yml`, with the following content:

```
---
- name: Configure the network
  hosts: managed-node-01.example.com
  tasks:
    - name: Configure an Ethernet connection with static IP
      ansible.builtin.include_role:
        name: rhel-system-roles.network
      vars:
        network_connections:
          - name: example
            match:
              path:
                - pci-0000:00:0[1-3].0
                - &!pci-0000:00:02.0
            type: ethernet
            autoconnect: yes
            ip:
              address:
                - 192.0.2.1/24
                - 2001:db8:1::1/64
              gateway4: 192.0.2.254
              gateway6: 2001:db8:1::fffe
            dns:
              - 192.0.2.200
              - 2001:db8:1::ffbb
            dns_search:
              - example.com
            state: up
```

These settings define an Ethernet connection profile with the following settings:

- A static IPv4 address - **192.0.2.1** with a **/24** subnet mask
  - A static IPv6 address - **2001:db8:1::1** with a **/64** subnet mask
  - An IPv4 default gateway - **192.0.2.254**
  - An IPv6 default gateway - **2001:db8:1::ffe**
  - An IPv4 DNS server - **192.0.2.200**
  - An IPv6 DNS server - **2001:db8:1::ffbb**
  - A DNS search domain - **example.com**
- The **match** parameter in this example defines that Ansible applies the play to devices that match PCI ID **0000:00:0[1-3].0**, but not **0000:00:02.0**. For further details about special modifiers and wild cards you can use, see the **match** parameter description in the **/usr/share/ansible/roles/rhel-system-roles.network/README.md** file.

2. Validate the playbook syntax:

```
$ ansible-playbook --syntax-check ~/playbook.yml
```

Note that this command only validates the syntax and does not protect against a wrong but valid configuration.

3. Run the playbook:

```
$ ansible-playbook ~/playbook.yml
```

#### Additional resources

- **/usr/share/ansible/roles/rhel-system-roles.network/README.md** file
- **/usr/share/doc/rhel-system-roles/network/** directory

## 2.9. CONFIGURING AN ETHERNET CONNECTION WITH A DYNAMIC IP ADDRESS BY USING NMSTATECTL

Use the **nmstatectl** utility to configure an Ethernet connection through the Nmstate API. The Nmstate API ensures that, after setting the configuration, the result matches the configuration file. If anything fails, **nmstatectl** automatically rolls back the changes to avoid leaving the system in an incorrect state.

#### Prerequisites

- A physical or virtual Ethernet Network Interface Controller (NIC) exists in the server's configuration.
- A DHCP server is available in the network.
- The **nmstate** package is installed.

#### Procedure

1. Create a YAML file, for example `~/create-ethernet-profile.yml`, with the following content:

```
---
interfaces:
- name: enp1s0
  type: ethernet
  state: up
  ipv4:
    enabled: true
    auto-dns: true
    auto-gateway: true
    auto-routes: true
    dhcp: true
  ipv6:
    enabled: true
    auto-dns: true
    auto-gateway: true
    auto-routes: true
    autoconf: true
    dhcp: true
```

These settings define an Ethernet connection profile for the **enp1s0** device. The connection retrieves IPv4 addresses, IPv6 addresses, default gateway, routes, DNS servers, and search domains from a DHCP server and IPv6 stateless address autoconfiguration (SLAAC).

2. Apply the settings to the system:

```
# nmstatectl apply ~/create-ethernet-profile.yml
```

## Verification

1. Display the current state in YAML format:

```
# nmstatectl show enp1s0
```

2. Display the IP settings of the NIC:

```
# ip address show enp1s0
2: enp1s0: <BROADCAST,MULTICAST,UP,LOWER_UP> mtu 1500 qdisc fq_codel state UP
group default qlen 1000
    link/ether 52:54:00:17:b8:b6 brd ff:ff:ff:ff:ff:ff
    inet 192.0.2.1/24 brd 192.0.2.255 scope global noprefixroute enp1s0
        valid_lft forever preferred_lft forever
    inet6 2001:db8:1::ffe/64 scope global noprefixroute
        valid_lft forever preferred_lft forever
```

3. Display the IPv4 default gateway:

```
# ip route show default
default via 192.0.2.254 dev enp1s0 proto static metric 102
```

4. Display the IPv6 default gateway:



```
# ip -6 route show default
```

```
default via 2001:db8:1::fee dev enp1s0 proto static metric 102 pref medium
```

5. Display the DNS settings:

```
# cat /etc/resolv.conf
```

```
search example.com
```

```
nameserver 192.0.2.200
```

```
nameserver 2001:db8:1::ffbb
```

If multiple connection profiles are active at the same time, the order of **nameserver** entries depend on the DNS priority values in these profile and the connection types.

6. Use the **ping** utility to verify that this host can send packets to other hosts:

```
# ping <host-name-or-IP-address>
```

### Additional resources

- **nmstatectl(8)** man page
- `/usr/share/doc/nmstate/examples/` directory

## 2.10. CONFIGURING AN ETHERNET CONNECTION WITH A DYNAMIC IP ADDRESS BY USING THE NETWORK RHEL SYSTEM ROLE WITH AN INTERFACE NAME

You can remotely configure an Ethernet connection using the **network** RHEL system role. For connections with dynamic IP address settings, NetworkManager requests the IP settings for the connection from a DHCP server.

### Prerequisites

- [You have prepared the control node and the managed nodes](#)
- You are logged in to the control node as a user who can run playbooks on the managed nodes.
- The account you use to connect to the managed nodes has **sudo** permissions on them.
- A physical or virtual Ethernet device exists in the server's configuration.
- A DHCP server is available in the network
- The managed nodes use NetworkManager to configure the network.

### Procedure

1. Create a playbook file, for example `~/playbook.yml`, with the following content:

```
---
- name: Configure the network
  hosts: managed-node-01.example.com
  tasks:
```

```
- name: Configure an Ethernet connection with dynamic IP
  ansible.builtin.include_role:
    name: rhel-system-roles.network
  vars:
    network_connections:
      - name: enp1s0
        interface_name: enp1s0
        type: ethernet
        autoconnect: yes
        ip:
          dhcp4: yes
          auto6: yes
        state: up
```

These settings define an Ethernet connection profile for the **enp1s0** device. The connection retrieves IPv4 addresses, IPv6 addresses, default gateway, routes, DNS servers, and search domains from a DHCP server and IPv6 stateless address autoconfiguration (SLAAC).

2. Validate the playbook syntax:

```
$ ansible-playbook --syntax-check ~/playbook.yml
```

Note that this command only validates the syntax and does not protect against a wrong but valid configuration.

3. Run the playbook:

```
$ ansible-playbook ~/playbook.yml
```

#### Additional resources

- `/usr/share/ansible/roles/rhel-system-roles.network/README.md` file
- `/usr/share/doc/rhel-system-roles/network/` directory

## 2.11. CONFIGURING AN ETHERNET CONNECTION WITH A DYNAMIC IP ADDRESS BY USING THE NETWORK RHEL SYSTEM ROLE WITH A DEVICE PATH

You can remotely configure an Ethernet connection using the **network** RHEL system role. For connections with dynamic IP address settings, NetworkManager requests the IP settings for the connection from a DHCP server.

You can identify the device path with the following command:

```
# udevadm info /sys/class/net/<device_name> | grep ID_PATH=
```

#### Prerequisites

- You have prepared the control node and the managed nodes
- You are logged in to the control node as a user who can run playbooks on the managed nodes.

- The account you use to connect to the managed nodes has **sudo** permissions on them.
- A physical or virtual Ethernet device exists in the server's configuration.
- A DHCP server is available in the network.
- The managed hosts use NetworkManager to configure the network.

## Procedure

1. Create a playbook file, for example `~/playbook.yml`, with the following content:

```
---
- name: Configure the network
  hosts: managed-node-01.example.com
  tasks:
    - name: Configure an Ethernet connection with dynamic IP
      ansible.builtin.include_role:
        name: rhel-system-roles.network
      vars:
        network_connections:
          - name: example
            match:
              path:
                - pci-0000:00:0[1-3].0
                - &!pci-0000:00:02.0
            type: ethernet
            autoconnect: yes
            ip:
              dhcp4: yes
              auto6: yes
            state: up
```

These settings define an Ethernet connection profile. The connection retrieves IPv4 addresses, IPv6 addresses, default gateway, routes, DNS servers, and search domains from a DHCP server and IPv6 stateless address autoconfiguration (SLAAC).

The **match** parameter defines that Ansible applies the play to devices that match PCI ID **0000:00:0[1-3].0**, but not **0000:00:02.0**.

2. Validate the playbook syntax:

```
$ ansible-playbook --syntax-check ~/playbook.yml
```

Note that this command only validates the syntax and does not protect against a wrong but valid configuration.

3. Run the playbook:

```
$ ansible-playbook ~/playbook.yml
```

## Additional resources

- `/usr/share/ansible/roles/rhel-system-roles.network/README.md` file

- `/usr/share/doc/rhel-system-roles/network/` directory

## 2.12. CONFIGURING MULTIPLE ETHERNET INTERFACES BY USING A SINGLE CONNECTION PROFILE BY INTERFACE NAME

In most cases, one connection profile contains the settings of one network device. However, NetworkManager also supports wildcards when you set the interface name in connection profiles. If a host roams between Ethernet networks with dynamic IP address assignment, you can use this feature to create a single connection profile that you can use for multiple Ethernet interfaces.

### Prerequisites

- Multiple physical or virtual Ethernet devices exist in the server's configuration.
- A DHCP server is available in the network.
- No connection profile exists on the host.

### Procedure

1. Add a connection profile that applies to all interface names starting with **enp**:

```
# nmcli connection add con-name Example connection.multi-connect multiple
match.interface-name enp* type ethernet
```

### Verification

1. Display all settings of the single connection profile:

```
# nmcli connection show Example
connection.id:          Example
...
connection.multi-connect: 3 (multiple)
match.interface-name:  enp*
...
```

**3** indicates the number of interfaces active on the connection profile at the same time, and not the number of network interfaces in the connection profile. The connection profile uses all devices that match the pattern in the **match.interface-name** parameter and, therefore, the connection profiles have the same Universally Unique Identifier (UUID).

2. Display the status of the connections:

```
# nmcli connection show
NAME          UUID          TYPE  DEVICE
...
Example 6f22402e-c0cc-49cf-b702-eaf0cd5ea7d1 ethernet enp7s0
Example 6f22402e-c0cc-49cf-b702-eaf0cd5ea7d1 ethernet enp8s0
Example 6f22402e-c0cc-49cf-b702-eaf0cd5ea7d1 ethernet enp9s0
```

### Additional resources

- [nmcli\(1\)](#) man page

- **nm-settings(5)** man page

## 2.13. CONFIGURING A SINGLE CONNECTION PROFILE FOR MULTIPLE ETHERNET INTERFACES USING PCI IDS

The PCI ID is a unique identifier of the devices connected to the system. The connection profile adds multiple devices by matching interfaces based on a list of PCI IDs. You can use this procedure to connect multiple device PCI IDs to the single connection profile.

### Prerequisites

- Multiple physical or virtual Ethernet devices exist in the server's configuration.
- A DHCP server is available in the network.
- No connection profile exists on the host.

### Procedure

1. Identify the device path. For example, to display the device paths of all interfaces starting with **enp**, enter :

```
# udevadm info /sys/class/net/enp* | grep ID_PATH=
...
E: ID_PATH=pci-0000:07:00.0
E: ID_PATH=pci-0000:08:00.0
```

2. Add a connection profile that applies to all PCI IDs matching the **0000:00:0[7-8].0** expression:

```
# nmcli connection add type ethernet connection.multi-connect multiple match.path
"pci-0000:07:00.0 pci-0000:08:00.0" con-name Example
```

### Verification

1. Display the status of the connection:

```
# nmcli connection show
NAME UUID TYPE DEVICE
Example 9cee0958-512f-4203-9d3d-b57af1d88466 ethernet enp7s0
Example 9cee0958-512f-4203-9d3d-b57af1d88466 ethernet enp8s0
...
```

2. To display all settings of the connection profile:

```
# nmcli connection show Example
connection.id: Example
...
connection.multi-connect: 3 (multiple)
match.path: pci-0000:07:00.0,pci-0000:08:00.0
...
```

This connection profile uses all devices with a PCI ID which match the pattern in the **match.path** parameter and, therefore, the connection profiles have the same Universally Unique Identifier (UUID).

#### Additional resources

- **nmcli(1)** man page
- **nm-settings(5)** man page

## CHAPTER 3. CONFIGURING NETWORK BONDING

A network bond is a method to combine or aggregate physical and virtual network interfaces to provide a logical interface with higher throughput or redundancy. In a bond, the kernel handles all operations exclusively. You can create bonds on different types of devices, such as Ethernet devices or VLANs.

Red Hat Enterprise Linux provides administrators different options to configure team devices. For example:

- Use **nmcli** to configure bond connections using the command line.
- Use the RHEL web console to configure bond connections using a web browser.
- Use **nmtui** to configure bond connections in a text-based user interface.
- Use the **nm-connection-editor** application to configure bond connections in a graphical interface.
- Use **nmstatectl** to configure bond connections through the Nmstate API.
- Use RHEL system roles to automate the bond configuration on one or multiple hosts.

### 3.1. UNDERSTANDING THE DEFAULT BEHAVIOR OF CONTROLLER AND PORT INTERFACES

Consider the following default behavior when managing or troubleshooting team or bond port interfaces using the **NetworkManager** service:

- Starting the controller interface does not automatically start the port interfaces.
- Starting a port interface always starts the controller interface.
- Stopping the controller interface also stops the port interface.
- A controller without ports can start static IP connections.
- A controller without ports waits for ports when starting DHCP connections.
- A controller with a DHCP connection waiting for ports completes when you add a port with a carrier.
- A controller with a DHCP connection waiting for ports continues waiting when you add a port without carrier.

### 3.2. UPSTREAM SWITCH CONFIGURATION DEPENDING ON THE BONDING MODES

Depending on the bonding mode you want to use, you must configure the ports on the switch:

Bonding mode	Configuration on the switch
<b>0 - balance-rr</b>	Requires static EtherChannel enabled, not Link Aggregation Control Protocol (LACP)-negotiated.

Bonding mode	Configuration on the switch
<b>1 - active-backup</b>	No configuration required on the switch.
<b>2 - balance-xor</b>	Requires static EtherChannel enabled, not LACP-negotiated.
<b>3 - broadcast</b>	Requires static EtherChannel enabled, not LACP-negotiated.
<b>4 - 802.3ad</b>	Requires LACP-negotiated EtherChannel enabled.
<b>5 - balance-tlb</b>	No configuration required on the switch.
<b>6 - balance-alb</b>	No configuration required on the switch.

For details how to configure your switch, see the documentation of the switch.



### IMPORTANT

Certain network bonding features, such as the fail-over mechanism, do not support direct cable connections without a network switch. For further details, see the [Is bonding supported with direct connection using crossover cables?](#) KCS solution.

## 3.3. CONFIGURING A NETWORK BOND BY USING NMCLI

To configure a network bond on the command line, use the **nmcli** utility.

### Prerequisites

- Two or more physical or virtual network devices are installed on the server.
- To use Ethernet devices as ports of the bond, the physical or virtual Ethernet devices must be installed on the server.
- To use team, bridge, or VLAN devices as ports of the bond, you can either create these devices while you create the bond or you can create them in advance as described in:
  - [Configuring a network team by using nmcli](#)
  - [Configuring a network bridge by using nmcli](#)
  - [Configuring VLAN tagging by using nmcli](#)

### Procedure

1. Create a bond interface:

```
# nmcli connection add type bond con-name bond0 ifname bond0 bond.options
"mode=active-backup"
```

This command creates a bond named **bond0** that uses the **active-backup** mode.



To additionally set a Media Independent Interface (MII) monitoring interval, add the **miimon=*interval*** option to the **bond.options** property, for example:

```
# nmcli connection add type bond con-name bond0 ifname bond0 bond.options
"mode=active-backup,miimon=1000"
```

2. Display the network interfaces, and note names of interfaces you plan to add to the bond:

```
# nmcli device status
DEVICE TYPE STATE CONNECTION
enp7s0 ethernet disconnected --
enp8s0 ethernet disconnected --
bridge0 bridge connected bridge0
bridge1 bridge connected bridge1
...
```

In this example:

- **enp7s0** and **enp8s0** are not configured. To use these devices as ports, add connection profiles in the next step.
- **bridge0** and **bridge1** have existing connection profiles. To use these devices as ports, modify their profiles in the next step.

3. Assign interfaces to the bond:

- a. If the interfaces you want to assign to the bond are not configured, create new connection profiles for them:

```
# nmcli connection add type ethernet slave-type bond con-name bond0-port1
ifname enp7s0 master bond0
# nmcli connection add type ethernet slave-type bond con-name bond0-port2
ifname enp8s0 master bond0
```

These commands create profiles for **enp7s0** and **enp8s0**, and add them to the **bond0** connection.

- b. To assign an existing connection profile to the bond:
  - i. Set the **master** parameter of these connections to **bond0**:

```
# nmcli connection modify bridge0 master bond0
# nmcli connection modify bridge1 master bond0
```

These commands assign the existing connection profiles named **bridge0** and **bridge1** to the **bond0** connection.

- ii. Reactivate the connections:

```
# nmcli connection up bridge0
# nmcli connection up bridge1
```

4. Configure the IPv4 settings:

- To use this bond device as a port of other devices, enter:

```
# nmcli connection modify bond0 ipv4.method disabled
```

- To use DHCP, no action is required.
- To set a static IPv4 address, network mask, default gateway, and DNS server to the **bond0** connection, enter:

```
# nmcli connection modify bond0 ipv4.addresses '192.0.2.1/24' ipv4.gateway
'192.0.2.254' ipv4.dns '192.0.2.253' ipv4.dns-search 'example.com' ipv4.method
manual
```

5. Configure the IPv6 settings:

- To use this bond device as a port of other devices, enter:

```
# nmcli connection modify bond0 ipv6.method disabled
```

- To use stateless address autoconfiguration (SLAAC), no action is required.
- To set a static IPv6 address, network mask, default gateway, and DNS server to the **bond0** connection, enter:

```
# nmcli connection modify bond0 ipv6.addresses '2001:db8:1::1/64' ipv6.gateway
'2001:db8:1::ffe' ipv6.dns '2001:db8:1::fffd' ipv6.dns-search 'example.com'
ipv6.method manual
```

6. Optional: If you want to set any parameters on the bond ports, use the following command:

```
# nmcli connection modify bond0-port1 bond-port.<parameter> <value>
```

7. Activate the connection:

```
# nmcli connection up bond0
```

8. Verify that the ports are connected, and the **CONNECTION** column displays the port's connection name:

```
# nmcli device
DEVICE TYPE STATE CONNECTION
...
enp7s0 ethernet connected bond0-port1
enp8s0 ethernet connected bond0-port2
```

When you activate any port of the connection, NetworkManager also activates the bond, but not the other ports of it. You can configure that Red Hat Enterprise Linux enables all ports automatically when the bond is enabled:

- Enable the **connection.autoconnect-slaves** parameter of the bond's connection:

```
# nmcli connection modify bond0 connection.autoconnect-slaves 1
```

- Reactivate the bridge:

```
# nmcli connection up bond0
```

### Verification

1. Temporarily remove the network cable from the host.  
Note that there is no method to properly test link failure events using software utilities. Tools that deactivate connections, such as **nmcli**, show only the bonding driver's ability to handle port configuration changes and not actual link failure events.
2. Display the status of the bond:

```
# cat /proc/net/bonding/bond0
```

### Additional resources

- [Configuring NetworkManager to avoid using a specific profile to provide a default gateway](#)
- [Network bonding documentation](#)

## 3.4. CONFIGURING A NETWORK BOND BY USING THE RHEL WEB CONSOLE

Use the RHEL web console to configure a network bond if you prefer to manage network settings using a web browser-based interface.

### Prerequisites

- You are logged in to the RHEL web console.
- Two or more physical or virtual network devices are installed on the server.
- To use Ethernet devices as members of the bond, the physical or virtual Ethernet devices must be installed on the server.
- To use team, bridge, or VLAN devices as members of the bond, create them in advance as described in:
  - [Configuring a network team by using the RHEL web console](#)
  - [Configuring a network bridge by using the RHEL web console](#)
  - [Configuring VLAN tagging by using the RHEL web console](#)

### Procedure

1. Select the **Networking** tab in the navigation on the left side of the screen.
2. Click **Add bond** in the **Interfaces** section.
3. Enter the name of the bond device you want to create.
4. Select the interfaces that should be members of the bond.
5. Select the mode of the bond.

- If you select **Active backup**, the web console shows the additional field **Primary** in which you can select the preferred active device.
- Set the link monitoring mode. For example, when you use the **Adaptive load balancing** mode, set it to **ARP**.
  - Optional: Adjust the monitoring interval, link up delay, and link down delay settings. Typically, you only change the defaults for troubleshooting purposes.

**Bond settings** ? ×

**Name**

**Interfaces**  enp7s0  
 enp8s0

**MAC**

**Mode**

**Primary**

**Link monitoring**

**Monitoring interval**

**Link up delay**

**Link down delay**

- Click **Apply**.
- By default, the bond uses a dynamic IP address. If you want to set a static IP address:
  - Click the name of the bond in the **Interfaces** section.

- b. Click **Edit** next to the protocol you want to configure.
- c. Select **Manual** next to **Addresses**, and enter the IP address, prefix, and default gateway.
- d. In the **DNS** section, click the **+** button, and enter the IP address of the DNS server. Repeat this step to set multiple DNS servers.
- e. In the **DNS search domains** section, click the **+** button, and enter the search domain.
- f. If the interface requires static routes, configure them in the **Routes** section.

### IPv4 settings ✕

Addresses Manual ▾ +

Address	Prefix length or netmask	Gateway	
<input type="text" value="192.0.2.1"/>	<input type="text" value="24"/>	<input type="text" value="192.0.2.254"/>	<span style="border: 1px solid gray; padding: 2px 5px;">-</span>

---

DNS  Automatic +

Server -

---

DNS search domains  Automatic +

Search domain -

---

Routes  Automatic +

Apply Cancel

- g. Click **Apply**

### Verification

1. Select the **Networking** tab in the navigation on the left side of the screen, and check if there is incoming and outgoing traffic on the interface:

Interfaces <span style="float: right;"> <span style="border: 1px solid blue; padding: 2px 5px; margin-right: 5px;">Add bond</span> <span style="border: 1px solid blue; padding: 2px 5px; margin-right: 5px;">Add team</span> <span style="border: 1px solid blue; padding: 2px 5px; margin-right: 5px;">Add bridge</span> <span style="border: 1px solid blue; padding: 2px 5px;">Add VLAN</span> </span>			
Name	IP address	Sending	Receiving
<b>bond0</b>	192.0.2.1/24	1.11 Mbps	61.2 Mbps

2. Temporarily remove the network cable from the host.

Note that there is no method to properly test link failure events using software utilities. Tools that deactivate connections, such as the web console, show only the bonding driver's ability to handle member configuration changes and not actual link failure events.

3. Display the status of the bond:

```
# cat /proc/net/bonding/bond0
```

### 3.5. CONFIGURING A NETWORK BOND BY USING NMTUI

The **nmtui** application provides a text-based user interface for NetworkManager. You can use **nmtui** to configure a network bond on a host without a graphical interface.

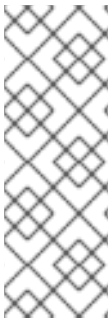

#### NOTE

In **nmtui**:

- Navigate by using the cursor keys.
- Press a button by selecting it and hitting **Enter**.
- Select and deselect checkboxes by using **Space**.

#### Prerequisites

- Two or more physical or virtual network devices are installed on the server.
- To use Ethernet devices as ports of the bond, the physical or virtual Ethernet devices must be installed on the server.

#### Procedure

1. If you do not know the network device names on which you want configure a network bond, display the available devices:

```
# nmcli device status
DEVICE  TYPE    STATE      CONNECTION
enp7s0  ethernet unavailable --
enp8s0  ethernet unavailable --
...
```

2. Start **nmtui**:

```
# nmtui
```

3. Select **Edit a connection**, and press **Enter**.
4. Press the **Add** button.
5. Select **Bond** from the list of network types, and press **Enter**.
6. Optional: Enter a name for the NetworkManager profile to be created.  
On hosts with multiple profiles, a meaningful name makes it easier to identify the purpose of a profile.

7. Enter the bond device name to be created into the **Device** field.
8. Add ports to the bond to be created:
  - a. Press the **Add** button next to the **Slaves** list.
  - b. Select the type of the interface you want to add as port to the bond, for example, **Ethernet**.
  - c. Optional: Enter a name for the NetworkManager profile to be created for this bond port.
  - d. Enter the port's device name into the **Device** field.
  - e. Press the **OK** button to return to the window with the bond settings.

**Figure 3.1. Adding an Ethernet device as port to a bond**

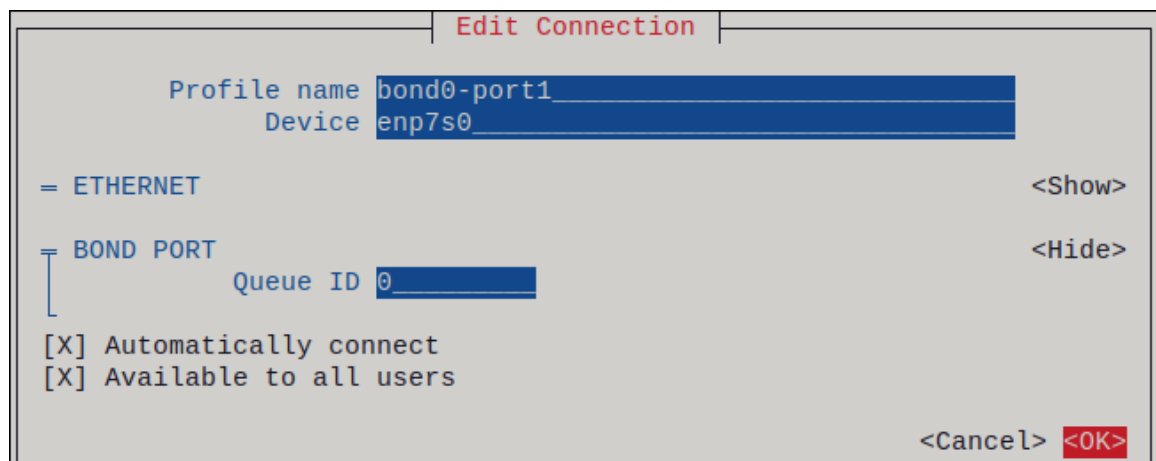

- f. Repeat these steps to add more ports to the bond.
9. Set the bond mode. Depending on the value you set, **nmtui** displays additional fields for settings that are related to the selected mode.
10. Depending on your environment, configure the IP address settings in the **IPv4 configuration** and **IPv6 configuration** areas accordingly. For this, press the button next to these areas, and select:
  - **Disabled**, if the bond does not require an IP address.
  - **Automatic**, if a DHCP server or stateless address autoconfiguration (SLAAC) dynamically assigns an IP address to the bond.
  - **Manual**, if the network requires static IP address settings. In this case, you must fill further fields:
    - i. Press the **Show** button next to the protocol you want to configure to display additional fields.
    - ii. Press the **Add** button next to **Addresses**, and enter the IP address and the subnet mask in Classless Inter-Domain Routing (CIDR) format.  
If you do not specify a subnet mask, NetworkManager sets a **/32** subnet mask for IPv4 addresses and **/64** for IPv6 addresses.
    - iii. Enter the address of the default gateway.
    - iv. Press the **Add** button next to **DNS servers**, and enter the DNS server address.

- v. Press the **Add** button next to **Search domains**, and enter the DNS search domain.

Figure 3.2. Example of a bond connection with static IP address settings

Edit Connection

Profile name   
 Device

**BOND** <Hide>  
 Slaves

↑  
 ↓

<Add>  
<Edit...>  
<Delete>

Mode   
 Primary   
 Link monitoring   
 Monitoring frequency  ms  
 Link up delay  ms  
 Link down delay  ms  
 Cloned MAC address

**IPv4 CONFIGURATION**  <Hide>

Addresses  <Remove>  
<Add...>

Gateway   
 DNS servers  <Remove>  
<Add...>

Search domains

Routing (No custom routes)   
 Never use this network for default route  
 Ignore automatically obtained routes  
 Ignore automatically obtained DNS parameters  
 Require IPv4 addressing for this connection

**IPv6 CONFIGURATION**  <Hide>

Addresses  <Remove>  
<Add...>

Gateway   
 DNS servers  <Remove>  
<Add...>

Search domains

Routing (No custom routes)   
 Never use this network for default route  
 Ignore automatically obtained routes  
 Ignore automatically obtained DNS parameters  
 Require IPv6 addressing for this connection

Automatically connect  
 Available to all users

<Cancel>



11. Press the **OK** button to create and automatically activate the new connection.
12. Press the **Back** button to return to the main menu.
13. Select **Quit**, and press **Enter** to close the **nmtui** application.

### Verification

1. Temporarily remove the network cable from the host.  
Note that there is no method to properly test link failure events using software utilities. Tools that deactivate connections, such as **nmcli**, show only the bonding driver's ability to handle port configuration changes and not actual link failure events.
2. Display the status of the bond:

```
# cat /proc/net/bonding/bond0
```

## 3.6. CONFIGURING A NETWORK BOND BY USING NM-CONNECTION-EDITOR

If you use Red Hat Enterprise Linux with a graphical interface, you can configure network bonds using the **nm-connection-editor** application.

Note that **nm-connection-editor** can add only new ports to a bond. To use an existing connection profile as a port, create the bond by using the **nmcli** utility as described in [Configuring a network bond by using nmcli](#).

### Prerequisites

- Two or more physical or virtual network devices are installed on the server.
- To use Ethernet devices as ports of the bond, the physical or virtual Ethernet devices must be installed on the server.
- To use team, bond, or VLAN devices as ports of the bond, ensure that these devices are not already configured.

### Procedure

1. Open a terminal, and enter **nm-connection-editor**:

```
$ nm-connection-editor
```

2. Click the **+** button to add a new connection.
3. Select the **Bond** connection type, and click **Create**.
4. On the **Bond** tab:
  - a. Optional: Set the name of the bond interface in the **Interface name** field.
  - b. Click the **Add** button to add a network interface as a port to the bond.
    - i. Select the connection type of the interface. For example, select **Ethernet** for a wired connection.

- ii. Optional: Set a connection name for the port.
  - iii. If you create a connection profile for an Ethernet device, open the **Ethernet** tab, and select in the **Device** field the network interface you want to add as a port to the bond. If you selected a different device type, configure it accordingly. Note that you can only use Ethernet interfaces in a bond that are not configured.
  - iv. Click **Save**.
- c. Repeat the previous step for each interface you want to add to the bond:

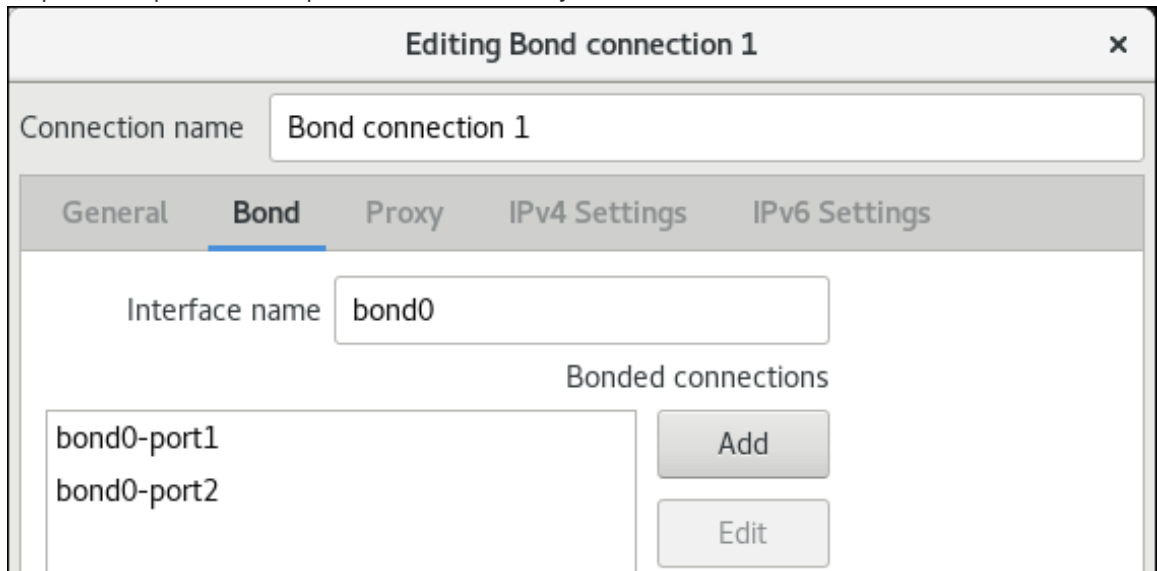

- d. Optional: Set other options, such as the Media Independent Interface (MII) monitoring interval.
5. Configure the IP address settings on both the **IPv4 Settings** and **IPv6 Settings** tabs:
- To use this bridge device as a port of other devices, set the **Method** field to **Disabled**.
  - To use DHCP, leave the **Method** field at its default, **Automatic (DHCP)**.
  - To use static IP settings, set the **Method** field to **Manual** and fill the fields accordingly:

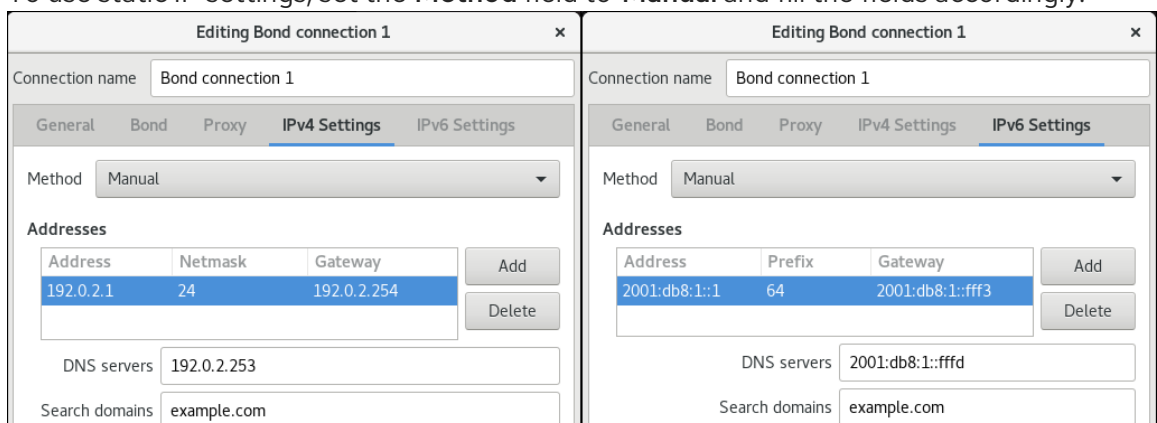

6. Click **Save**.
7. Close **nm-connection-editor**.

## Verification

1. Temporarily remove the network cable from the host.

Note that there is no method to properly test link failure events using software utilities. Tools that deactivate connections, such as **nmcli**, show only the bonding driver's ability to handle port configuration changes and not actual link failure events.

2. Display the status of the bond:

```
# cat /proc/net/bonding/bond0
```

### Additional resources

- [Configuring NetworkManager to avoid using a specific profile to provide a default gateway](#)
- [Configuring a network team by using nm-connection-editor](#)
- [Configuring a network bridge by using nm-connection-editor](#)
- [Configuring VLAN tagging by using nm-connection-editor](#)

## 3.7. CONFIGURING A NETWORK BOND BY USING NMSTATECTL

Use the **nmstatectl** utility to configure a network bond through the Nmstate API. The Nmstate API ensures that, after setting the configuration, the result matches the configuration file. If anything fails, **nmstatectl** automatically rolls back the changes to avoid leaving the system in an incorrect state.

Depending on your environment, adjust the YAML file accordingly. For example, to use different devices than Ethernet adapters in the bond, adapt the **base-iface** attribute and **type** attributes of the ports you use in the bond.

### Prerequisites

- Two or more physical or virtual network devices are installed on the server.
- To use Ethernet devices as ports in the bond, the physical or virtual Ethernet devices must be installed on the server.
- To use team, bridge, or VLAN devices as ports in the bond, set the interface name in the **port** list, and define the corresponding interfaces.
- The **nmstate** package is installed.

### Procedure

1. Create a YAML file, for example **~/create-bond.yml**, with the following content:

```
---
interfaces:
- name: bond0
  type: bond
  state: up
  ipv4:
    enabled: true
    address:
    - ip: 192.0.2.1
      prefix-length: 24
    dhcp: false
```

```
ipv6:
  enabled: true
  address:
    - ip: 2001:db8:1::1
      prefix-length: 64
  autoconf: false
  dhcp: false
link-aggregation:
  mode: active-backup
  port:
    - enp1s0
    - enp7s0
- name: enp1s0
  type: ethernet
  state: up
- name: enp7s0
  type: ethernet
  state: up

routes:
  config:
    - destination: 0.0.0.0/0
      next-hop-address: 192.0.2.254
      next-hop-interface: bond0
    - destination: ::0
      next-hop-address: 2001:db8:1::fffe
      next-hop-interface: bond0

dns-resolver:
  config:
    search:
      - example.com
    server:
      - 192.0.2.200
      - 2001:db8:1::ffbb
```

These settings define a network bond with the following settings:

- Network interfaces in the bond: **enp1s0** and **enp7s0**
- Mode: **active-backup**
- Static IPv4 address: **192.0.2.1** with a **/24** subnet mask
- Static IPv6 address: **2001:db8:1::1** with a **/64** subnet mask
- IPv4 default gateway: **192.0.2.254**
- IPv6 default gateway: **2001:db8:1::fffe**
- IPv4 DNS server: **192.0.2.200**
- IPv6 DNS server: **2001:db8:1::ffbb**
- DNS search domain: **example.com**

2. Apply the settings to the system:

```
# nmstatectl apply ~/create-bond.yml
```

## Verification

1. Display the status of the devices and connections:

```
# nmcli device status
DEVICE  TYPE  STATE  CONNECTION
bond0   bond  connected bond0
```

2. Display all settings of the connection profile:

```
# nmcli connection show bond0
connection.id:      bond0
connection.uuid:    79cbc3bd-302e-4b1f-ad89-f12533b818ee
connection.stable-id:  --
connection.type:    bond
connection.interface-name: bond0
...
```

3. Display the connection settings in YAML format:

```
# nmstatectl show bond0
```

## Additional resources

- [nmstatectl\(8\)](#) man page
- [/usr/share/doc/nmstate/examples/](#) directory

## 3.8. CONFIGURING A NETWORK BOND BY USING THE NETWORK RHEL SYSTEM ROLE

You can remotely configure a network bond by using the **network** RHEL system role.

### Prerequisites

- [You have prepared the control node and the managed nodes](#)
- You are logged in to the control node as a user who can run playbooks on the managed nodes.
- The account you use to connect to the managed nodes has **sudo** permissions on them.
- Two or more physical or virtual network devices are installed on the server.

### Procedure

1. Create a playbook file, for example `~/playbook.yml`, with the following content:

```
---
- name: Configure the network
  hosts: managed-node-01.example.com
```

```

tasks:
- name: Configure a network bond that uses two Ethernet ports
  ansible.builtin.include_role:
    name: rhel-system-roles.network
  vars:
    network_connections:
      # Define the bond profile
      - name: bond0
        type: bond
        interface_name: bond0
        ip:
          address:
            - "192.0.2.1/24"
            - "2001:db8:1::1/64"
          gateway4: 192.0.2.254
          gateway6: 2001:db8:1::ffe
          dns:
            - 192.0.2.200
            - 2001:db8:1::ffbb
          dns_search:
            - example.com
        bond:
          mode: active-backup
          state: up

      # Add an Ethernet profile to the bond
      - name: bond0-port1
        interface_name: enp7s0
        type: ethernet
        controller: bond0
        state: up

      # Add a second Ethernet profile to the bond
      - name: bond0-port2
        interface_name: enp8s0
        type: ethernet
        controller: bond0
        state: up

```

These settings define a network bond with the following settings:

- A static IPv4 address - **192.0.2.1** with a **/24** subnet mask
- A static IPv6 address - **2001:db8:1::1** with a **/64** subnet mask
- An IPv4 default gateway - **192.0.2.254**
- An IPv6 default gateway - **2001:db8:1::ffe**
- An IPv4 DNS server - **192.0.2.200**
- An IPv6 DNS server - **2001:db8:1::ffbb**
- A DNS search domain - **example.com**
- Ports of the bond - **enp7s0** and **enp8s0**

- Bond mode - **active-backup**

**NOTE**

Set the IP configuration on the bond and not on the ports of the Linux bond.

2. Validate the playbook syntax:

```
$ ansible-playbook --syntax-check ~/playbook.yml
```

Note that this command only validates the syntax and does not protect against a wrong but valid configuration.

3. Run the playbook:

```
$ ansible-playbook ~/playbook.yml
```

**Additional resources**

- `/usr/share/ansible/roles/rhel-system-roles.network/README.md` file
- `/usr/share/doc/rhel-system-roles/network/` directory

### 3.9. CREATING A NETWORK BOND TO ENABLE SWITCHING BETWEEN AN ETHERNET AND WIRELESS CONNECTION WITHOUT INTERRUPTING THE VPN

RHEL users who connect their workstation to their company's network typically use a VPN to access remote resources. However, if the workstation switches between an Ethernet and Wi-Fi connection, for example, if you release a laptop from a docking station with an Ethernet connection, the VPN connection is interrupted. To avoid this problem, you can create a network bond that uses the Ethernet and Wi-Fi connection in **active-backup** mode.

**Prerequisites**

- The host contains an Ethernet and a Wi-Fi device.
- An Ethernet and Wi-Fi NetworkManager connection profile has been created and both connections work independently.

This procedure uses the following connection profiles to create a network bond named **bond0**:

- **Docking\_station** associated with the **enp11s0u1** Ethernet device
- **Wi-Fi** associated with the **wlp1s0** Wi-Fi device

**Procedure**

1. Create a bond interface in **active-backup** mode:

```
# nmcli connection add type bond con-name bond0 ifname bond0 bond.options "mode=active-backup"
```

This command names both the interface and connection profile **bond0**.

## 2. Configure the IPv4 settings of the bond:

- If a DHCP server in your network assigns IPv4 addresses to hosts, no action is required.
- If your local network requires static IPv4 addresses, set the address, network mask, default gateway, DNS server, and DNS search domain to the **bond0** connection:

```
# nmcli connection modify bond0 ipv4.addresses '192.0.2.1/24'
# nmcli connection modify bond0 ipv4.gateway '192.0.2.254'
# nmcli connection modify bond0 ipv4.dns '192.0.2.253'
# nmcli connection modify bond0 ipv4.dns-search 'example.com'
# nmcli connection modify bond0 ipv4.method manual
```

## 3. Configure the IPv6 settings of the bond:

- If your router or a DHCP server in your network assigns IPv6 addresses to hosts, no action is required.
- If your local network requires static IPv6 addresses, set the address, network mask, default gateway, DNS server, and DNS search domain to the **bond0** connection:

```
# nmcli connection modify bond0 ipv6.addresses '2001:db8:1::1/64'
# nmcli connection modify bond0 ipv6.gateway '2001:db8:1::ffff'
# nmcli connection modify bond0 ipv6.dns '2001:db8:1::fffd'
# nmcli connection modify bond0 ipv6.dns-search 'example.com'
# nmcli connection modify bond0 ipv6.method manual
```

## 4. Display the connection profiles:

```
# nmcli connection show
NAME          UUID                                  TYPE  DEVICE
Docking_station 256dd073-fecc-339d-91ae-9834a00407f9 ethernet enp11s0u1
Wi-Fi          1f1531c7-8737-4c60-91af-2d21164417e8 wifi    wlp1s0
...
```

You require the names of the connection profiles and the Ethernet device name in the next steps.

## 5. Assign the connection profile of the Ethernet connection to the bond:

```
# nmcli connection modify Docking_station master bond0
```

## 6. Assign the connection profile of the Wi-Fi connection to the bond:

```
# nmcli connection modify Wi-Fi master bond0
```

7. If your Wi-Fi network uses MAC filtering to allow only MAC addresses on a allow list to access the network, configure that NetworkManager dynamically assigns the MAC address of the active port to the bond:

```
# nmcli connection modify bond0 +bond.options fail_over_mac=1
```

With this setting, you must set only the MAC address of the Wi-Fi device to the allow list instead of the MAC address of both the Ethernet and Wi-Fi device.



- Set the device associated with the Ethernet connection as primary device of the bond:

```
# nmcli con modify bond0 +bond.options "primary=enp11s0u1"
```

With this setting, the bond always uses the Ethernet connection if it is available.

- Configure that NetworkManager automatically activates ports when the **bond0** device is activated:

```
# nmcli connection modify bond0 connection.autoconnect-slaves 1
```

- Activate the **bond0** connection:

```
# nmcli connection up bond0
```

## Verification

- Display the currently active device, the status of the bond and its ports:

```
# cat /proc/net/bonding/bond0
Ethernet Channel Bonding Driver: v3.7.1 (April 27, 2011)

Bonding Mode: fault-tolerance (active-backup) (fail_over_mac active)
Primary Slave: enp11s0u1 (primary_reselect always)
Currently Active Slave: enp11s0u1
MII Status: up
MII Polling Interval (ms): 1
Up Delay (ms): 0
Down Delay (ms): 0
Peer Notification Delay (ms): 0

Slave Interface: enp11s0u1
MII Status: up
Speed: 1000 Mbps
Duplex: full
Link Failure Count: 0
Permanent HW addr: 00:53:00:59:da:b7
Slave queue ID: 0

Slave Interface: wlp1s0
MII Status: up
Speed: Unknown
Duplex: Unknown
Link Failure Count: 2
Permanent HW addr: 00:53:00:b3:22:ba
Slave queue ID: 0
```

## Additional resources

- [Configuring an Ethernet connection](#)
- [Managing Wi-Fi connections](#)
- [Configuring network bonding](#)

## 3.10. THE DIFFERENT NETWORK BONDING MODES

The Linux bonding driver provides link aggregation. Bonding is the process of aggregating multiple network interfaces in parallel to provide a single logical bonded interface. The actions of a bonded interface depend on the bonding policy that is also known as mode. The different modes provide either load-balancing or hot standby services.

The following modes exist:

### Balance-rr (Mode 0)

**Balance-rr** uses the round-robin algorithm that sequentially transmits packets from the first available port to the last one. This mode provides load balancing and fault tolerance.

This mode requires switch configuration of a port aggregation group, also called EtherChannel or similar port grouping. An EtherChannel is a port link aggregation technology to group multiple physical Ethernet links to one logical Ethernet link.

The drawback of this mode is that it is not suitable for heavy workloads and if TCP throughput or ordered packet delivery is essential.

### Active-backup (Mode 1)

**Active-backup** uses the policy that determines that only one port is active in the bond. This mode provides fault tolerance and does not require any switch configuration.

If the active port fails, an alternate port becomes active. The bond sends a gratuitous address resolution protocol (ARP) response to the network. The gratuitous ARP forces the receiver of the ARP frame to update their forwarding table. The **Active-backup** mode transmits a gratuitous ARP to announce the new path to maintain connectivity for the host.

The **primary** option defines the preferred port of the bonding interface.

### Balance-xor (Mode 2)

**Balance-xor** uses the selected transmit hash policy to send the packets. This mode provides load balancing, fault tolerance, and requires switch configuration to set up an Etherchannel or similar port grouping.

To alter packet transmission and balance transmit, this mode uses the **xmit\_hash\_policy** option. Depending on the source or destination of traffic on the interface, the interface requires an additional load-balancing configuration. See description [xmit\\_hash\\_policy bonding parameter](#).

### Broadcast (Mode 3)

**Broadcast** uses a policy that transmits every packet on all interfaces. This mode provides fault tolerance and requires a switch configuration to set up an EtherChannel or similar port grouping.

The drawback of this mode is that it is not suitable for heavy workloads and if TCP throughput or ordered packet delivery is essential.

### 802.3ad (Mode 4)

**802.3ad** uses the same-named IEEE standard dynamic link aggregation policy. This mode provides fault tolerance. This mode requires switch configuration to set up a Link Aggregation Control Protocol (LACP) port grouping.

This mode creates aggregation groups that share the same speed and duplex settings and utilizes all ports in the active aggregator. Depending on the source or destination of traffic on the interface, this mode requires an additional load-balancing configuration.

By default, the port selection for outgoing traffic depends on the transmit hash policy. Use the **xmit\_hash\_policy** option of the transmit hash policy to change the port selection and balance transmit.

The difference between the **802.3ad** and the **Balance-xor** is compliance. The **802.3ad** policy negotiates LACP between the port aggregation groups. See description [xmit\\_hash\\_policy bonding parameter](#)

### Balance-tlb (Mode 5)

**Balance-tlb** uses the transmit load balancing policy. This mode provides fault tolerance, load balancing, and establishes channel bonding that does not require any switch support.

The active port receives the incoming traffic. In case of failure of the active port, another one takes over the MAC address of the failed port. To decide which interface processes the outgoing traffic, use one of the following modes:

- Value **0**: Uses the hash distribution policy to distribute traffic without load balancing
- Value **1**: Distributes traffic to each port by using load balancing  
With the bonding option **tlb\_dynamic\_lb=0**, this bonding mode uses the **xmit\_hash\_policy** bonding option to balance transmit. The **primary** option defines the preferred port of the bonding interface.

See description [xmit\\_hash\\_policy bonding parameter](#).

### Balance-alb (Mode 6)

**Balance-alb** uses an adaptive load balancing policy. This mode provides fault tolerance, load balancing, and does not require any special switch support.

This mode includes balance-transmit load balancing (**balance-tlb**) and receive-load balancing for IPv4 and IPv6 traffic. The bonding intercepts ARP replies sent by the local system and overwrites the source hardware address of one of the ports in the bond. ARP negotiation manages the receive-load balancing. Therefore, different ports use different hardware addresses for the server.

The **primary** option defines the preferred port of the bonding interface. With the bonding option **tlb\_dynamic\_lb=0**, this bonding mode uses the **xmit\_hash\_policy** bonding option to balance transmit. See description [xmit\\_hash\\_policy bonding parameter](#).

### Additional resources

- [/usr/share/doc/kernel-doc-<version>/Documentation/networking/bonding.rst](#) provided by the **kernel-doc** package
- [/usr/share/doc/kernel-doc-<version>/Documentation/networking/bonding.txt](#) provided by the **kernel-doc** package
- [Which bonding modes work when used with a bridge that virtual machine guests or containers connect to?](#)
- [How are the values for different policies in "xmit\\_hash\\_policy" bonding parameter calculated?](#)

## 3.11. THE XMIT\_HASH\_POLICY BONDING PARAMETER

The **xmit\_hash\_policy** load balancing parameter selects the transmit hash policy for a node selection in the **balance-xor**, **802.3ad**, **balance-alb**, and **balance-tlb** modes. It is only applicable to mode 5 and 6 if the **tlb\_dynamic\_lb** parameter is **0**. The possible values of this parameter are **layer2**, **layer2+3**,

**layer3+4, encap2+3, encap3+4, and vlan+srcmac.**

Refer the table for details:

Policy or Network layers	Layer2	Layer2+3	Layer3+4	encap2+3	encap3+4	VLAN+src mac
<b>Uses</b>	XOR of source and destination MAC addresses and Ethernet protocol type	XOR of source and destination MAC addresses and IP addresses	XOR of source and destination ports and IP addresses	XOR of source and destination MAC addresses and IP addresses inside a supported tunnel, for example, Virtual Extensible LAN (VXLAN). This mode relies on <b>skb_flow_dissect()</b> function to obtain the header fields	XOR of source and destination ports and IP addresses inside a supported tunnel, for example, VXLAN. This mode relies on <b>skb_flow_dissect()</b> function to obtain the header fields	XOR of VLAN ID and source MAC vendor and source MAC device
<b>Placement of traffic</b>	All traffic to a particular network peer on the same underlying network interface	All traffic to a particular IP address on the same underlying network interface	All traffic to a particular IP address and port on the same underlying network interface			

<b>Primary choice</b>	If network traffic is between this system and multiple other systems in the same broadcast domain	If network traffic between this system and multiple other systems goes through a default gateway	If network traffic between this system and another system uses the same IP addresses but goes through multiple ports	The encapsulated traffic is between the source system and multiple other systems using multiple IP addresses	The encapsulated traffic is between the source system and other systems using multiple port numbers	If the bond carries network traffic, from multiple containers or virtual machines (VM), that expose their MAC address directly to the external network such as the bridge network, and you can not configure a switch for Mode 2 or Mode 4
<b>Secondary choice</b>	If network traffic is mostly between this system and multiple other systems behind a default gateway	If network traffic is mostly between this system and another system				
<b>Compliant</b>	802.3ad	802.3ad	Not 802.3ad			
<b>Default policy</b>	This is the default policy if no configuration is provided	For non-IP traffic, the formula is the same as for the <b>layer2</b> transmit policy	For non-IP traffic, the formula is the same as for the <b>layer2</b> transmit policy			

## CHAPTER 4. CONFIGURING NETWORK TEAMING

A network team is a method to combine or aggregate physical and virtual network interfaces to provide a logical interface with higher throughput or redundancy. Network teaming uses a small kernel module to implement fast handling of packet flows and a user-space service for other tasks. This way, network teaming is an easily extensible and scalable solution for load-balancing and redundancy requirements.

Red Hat Enterprise Linux provides administrators different options to configure team devices. For example:

- Use **nmcli** to configure teams connections using the command line.
- Use the RHEL web console to configure team connections using a web browser.
- Use the **nm-connection-editor** application to configure team connections in a graphical interface.



### IMPORTANT

Network teaming is deprecated in Red Hat Enterprise Linux 9. If you plan to upgrade your server to a future version of RHEL, consider using the kernel bonding driver as an alternative. For details, see [Configuring network bonding](#).

### 4.1. UNDERSTANDING THE DEFAULT BEHAVIOR OF CONTROLLER AND PORT INTERFACES

Consider the following default behavior when managing or troubleshooting team or bond port interfaces using the **NetworkManager** service:

- Starting the controller interface does not automatically start the port interfaces.
- Starting a port interface always starts the controller interface.
- Stopping the controller interface also stops the port interface.
- A controller without ports can start static IP connections.
- A controller without ports waits for ports when starting DHCP connections.
- A controller with a DHCP connection waiting for ports completes when you add a port with a carrier.
- A controller with a DHCP connection waiting for ports continues waiting when you add a port without carrier.

### 4.2. UNDERSTANDING THE TEAMD SERVICE, RUNNERS, AND LINK-WATCHERS

The team service, **teamd**, controls one instance of the team driver. This instance of the driver adds instances of a hardware device driver to form a team of network interfaces. The team driver presents a network interface, for example **team0**, to the kernel.

The **teamd** service implements the common logic to all methods of teaming. Those functions are unique to the different load sharing and backup methods, such as round-robin, and implemented by separate

units of code referred to as **runners**. Administrators specify runners in JavaScript Object Notation (JSON) format, and the JSON code is compiled into an instance of **teamd** when the instance is created. Alternatively, when using **NetworkManager**, you can set the runner in the **team.runner** parameter, and **NetworkManager** auto-creates the corresponding JSON code.

The following runners are available:

- **broadcast**: Transmits data over all ports.
- **roundrobin**: Transmits data over all ports in turn.
- **activebackup**: Transmits data over one port while the others are kept as a backup.
- **loadbalance**: Transmits data over all ports with active Tx load balancing and Berkeley Packet Filter (BPF)-based Tx port selectors.
- **random**: Transmits data on a randomly selected port.
- **lACP**: Implements the 802.3ad Link Aggregation Control Protocol (LACP).

The **teamd** services uses a link watcher to monitor the state of subordinate devices. The following link-watchers are available:

- **ethtool**: The **libteam** library uses the **ethtool** utility to watch for link state changes. This is the default link-watcher.
- **arp\_ping**: The **libteam** library uses the **arp\_ping** utility to monitor the presence of a far-end hardware address using Address Resolution Protocol (ARP).
- **nsna\_ping**: On IPv6 connections, the **libteam** library uses the Neighbor Advertisement and Neighbor Solicitation features from the IPv6 Neighbor Discovery protocol to monitor the presence of a neighbor's interface.

Each runner can use any link watcher, with the exception of **lACP**. This runner can only use the **ethtool** link watcher.

### 4.3. CONFIGURING A NETWORK TEAM BY USING NMCLI

To configure a network team on the command line, use the **nmcli** utility.



#### IMPORTANT

Network teaming is deprecated in Red Hat Enterprise Linux 9. If you plan to upgrade your server to a future version of RHEL, consider using the kernel bonding driver as an alternative. For details, see [Configuring network bonding](#).

#### Prerequisites

- The **teamd** and **NetworkManager-team** packages are installed.
- Two or more physical or virtual network devices are installed on the server.
- To use Ethernet devices as ports of the team, the physical or virtual Ethernet devices must be installed on the server and connected to a switch.

- To use bond, bridge, or VLAN devices as ports of the team, you can either create these devices while you create the team or you can create them in advance as described in:
  - [Configuring a network bond by using nmcli](#)
  - [Configuring a network bridge by using nmcli](#)
  - [Configuring VLAN tagging by using nmcli](#)

## Procedure

1. Create a team interface:

```
# nmcli connection add type team con-name team0 ifname team0 team.runner
activebackup
```

This command creates a network team named **team0** that uses the **activebackup** runner.

2. Optionally, set a link watcher. For example, to set the **ethtool** link watcher in the **team0** connection profile:

```
# nmcli connection modify team0 team.link-watchers "name=ethtool"
```

Link watchers support different parameters. To set parameters for a link watcher, specify them space-separated in the **name** property. Note that the name property must be surrounded by quotation marks. For example, to use the **ethtool** link watcher and set its **delay-up** parameter to **2500** milliseconds (2.5 seconds):

```
# nmcli connection modify team0 team.link-watchers "name=ethtool delay-up=2500"
```

To set multiple link watchers and each of them with specific parameters, the link watchers must be separated by a comma. The following example sets the **ethtool** link watcher with the **delay-up** parameter and the **arp\_ping** link watcher with the **source-host** and **target-host** parameter:

```
# nmcli connection modify team0 team.link-watchers "name=ethtool delay-up=2,
name=arp_ping source-host=192.0.2.1 target-host=192.0.2.2"
```

3. Display the network interfaces, and note the names of the interfaces you want to add to the team:

```
# nmcli device status
DEVICE TYPE    STATE    CONNECTION
enp7s0 ethernet disconnected --
enp8s0 ethernet disconnected --
bond0 bond    connected bond0
bond1 bond    connected bond1
...
```

In this example:

- **enp7s0** and **enp8s0** are not configured. To use these devices as ports, add connection profiles in the next step. Note that you can only use Ethernet interfaces in a team that are not assigned to any connection.



- **bond0** and **bond1** have existing connection profiles. To use these devices as ports, modify their profiles in the next step.

4. Assign the port interfaces to the team:

- a. If the interfaces you want to assign to the team are not configured, create new connection profiles for them:

```
# nmcli connection add type ethernet slave-type team con-name team0-port1
  ifname enp7s0 master team0
# nmcli connection add type ethernet slave-type team con-name team0-port2
  ifname enp8s0 master team0
```

These commands create profiles for **enp7s0** and **enp8s0**, and add them to the **team0** connection.

- b. To assign an existing connection profile to the team:

- i. Set the **master** parameter of these connections to **team0**:

```
# nmcli connection modify bond0 master team0
# nmcli connection modify bond1 master team0
```

These commands assign the existing connection profiles named **bond0** and **bond1** to the **team0** connection.

- ii. Reactivate the connections:

```
# nmcli connection up bond0
# nmcli connection up bond1
```

5. Configure the IPv4 settings:

- To use this team device as a port of other devices, enter:

```
# nmcli connection modify team0 ipv4.method disabled
```

- To use DHCP, no action is required.
- To set a static IPv4 address, network mask, default gateway, and DNS server to the **team0** connection, enter:

```
# nmcli connection modify team0 ipv4.addresses '192.0.2.1/24' ipv4.gateway
  '192.0.2.254' ipv4.dns '192.0.2.253' ipv4.dns-search 'example.com' ipv4.method
  manual
```

6. Configure the IPv6 settings:

- To use this team device as a port of other devices, enter:

```
# nmcli connection modify team0 ipv6.method disabled
```

- To use stateless address autoconfiguration (SLAAC), no action is required.

- To set a static IPv6 address, network mask, default gateway, and DNS server to the **team0** connection, enter:

```
# nmcli connection modify team0 ipv6.addresses '2001:db8:1::1/64' ipv6.gateway  
'2001:db8:1::ffff' ipv6.dns '2001:db8:1::ffff' ipv6.dns-search 'example.com'  
ipv6.method manual
```

7. Activate the connection:

```
# nmcli connection up team0
```

## Verification

- Display the status of the team:

```
# teamdctl team0 state  
setup:  
  runner: activebackup  
ports:  
  enp7s0  
    link watches:  
      link summary: up  
      instance[link_watch_0]:  
        name: ethtool  
        link: up  
        down count: 0  
  enp8s0  
    link watches:  
      link summary: up  
      instance[link_watch_0]:  
        name: ethtool  
        link: up  
        down count: 0  
runner:  
  active port: enp7s0
```

In this example, both ports are up.

## Additional resources

- [Configuring NetworkManager to avoid using a specific profile to provide a default gateway](#)
- [Understanding the teamd service, runners, and link-watchers](#)
- **nm-settings(5)** man page
- **teamd.conf(5)** man page

## 4.4. CONFIGURING A NETWORK TEAM BY USING THE RHEL WEB CONSOLE

Use the RHEL web console to configure a network team if you prefer to manage network settings using a web browser-based interface.

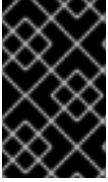

## IMPORTANT

Network teaming is deprecated in Red Hat Enterprise Linux 9. If you plan to upgrade your server to a future version of RHEL, consider using the kernel bonding driver as an alternative. For details, see [Configuring network bonding](#).

### Prerequisites

- The **teamd** and **NetworkManager-team** packages are installed.
- Two or more physical or virtual network devices are installed on the server.
- To use Ethernet devices as ports of the team, the physical or virtual Ethernet devices must be installed on the server and connected to a switch.
- To use bond, bridge, or VLAN devices as ports of the team, create them in advance as described in:
  - [Configuring a network bond by using the RHEL web console](#)
  - [Configuring a network bridge by using the RHEL web console](#)
  - [Configuring VLAN tagging by using the RHEL web console](#)

### Procedure

1. Select the **Networking** tab in the navigation on the left side of the screen.
2. Click **Add team** in the **Interfaces** section.
3. Enter the name of the team device you want to create.
4. Select the interfaces that should be ports of the team.
5. Select the runner of the team.  
If you select **Load balancing** or **802.3ad LACP**, the web console shows the additional field **Balancer**.
6. Set the link watcher:
  - If you select **Ethtool**, additionally, set a link up and link down delay.
  - If you set **ARP ping** or **NSNA ping**, additionally, set a ping interval and ping target.

## Team settings ✕

**Name**

**Ports**  enp7s0  
 enp8s0

**Runner**

**Link watch**

**Link up delay**

**Link down delay**

7. Click **Apply**.
8. By default, the team uses a dynamic IP address. If you want to set a static IP address:
  - a. Click the name of the team in the **Interfaces** section.
  - b. Click **Edit** next to the protocol you want to configure.
  - c. Select **Manual** next to **Addresses**, and enter the IP address, prefix, and default gateway.
  - d. In the **DNS** section, click the **+** button, and enter the IP address of the DNS server. Repeat this step to set multiple DNS servers.
  - e. In the **DNS search domains** section, click the **+** button, and enter the search domain.
  - f. If the interface requires static routes, configure them in the **Routes** section.

### IPv4 settings ✕

Addresses Manual ▾ +

Address	Prefix length or netmask	Gateway	
<input type="text" value="192.0.2.1"/>	<input type="text" value="24"/>	<input type="text" value="192.0.2.254"/>	<span style="border: 1px solid gray; padding: 2px 5px;">-</span>

---

DNS  Automatic +

Server -

---

DNS search domains  Automatic +

Search domain -

---

Routes  Automatic +

Apply Cancel

g. Click **Apply**

### Verification

1. Select the **Networking** tab in the navigation on the left side of the screen, and check if there is incoming and outgoing traffic on the interface.

Interfaces <span style="float: right;"> <span style="border: 1px solid gray; padding: 2px 5px; margin-right: 5px;">Add bond</span> <span style="border: 1px solid gray; padding: 2px 5px; margin-right: 5px;">Add team</span> <span style="border: 1px solid gray; padding: 2px 5px; margin-right: 5px;">Add bridge</span> <span style="border: 1px solid gray; padding: 2px 5px;">Add VLAN</span> </span>				
Name	IP address	Sending	Receiving	
<b>team0</b>	192.0.2.1/24	1.11 Mbps	61.2 Mbps	

2. Display the status of the team:

```
# teamdctl team0 state
setup:
runner: activebackup
ports:
enp7s0
link watches:
link summary: up
instance[link_watch_0]:
name: ethtool
link: up
```

```

    down count: 0
enp8s0
  link watches:
  link summary: up
  instance[link_watch_0]:
    name: ethtool
    link: up
    down count: 0
runner:
  active port: enp7s0

```

In this example, both ports are up.

### Additional resources

- [Network team runners](#)

## 4.5. CONFIGURING A NETWORK TEAM BY USING NM-CONNECTION-EDITOR

If you use Red Hat Enterprise Linux with a graphical interface, you can configure network teams using the **nm-connection-editor** application.

Note that **nm-connection-editor** can add only new ports to a team. To use an existing connection profile as a port, create the team using the **nmcli** utility as described in [Configuring a network team by using nmcli](#).



### IMPORTANT

Network teaming is deprecated in Red Hat Enterprise Linux 9. If you plan to upgrade your server to a future version of RHEL, consider using the kernel bonding driver as an alternative. For details, see [Configuring network bonding](#).

### Prerequisites

- The **teamd** and **NetworkManager-team** packages are installed.
- Two or more physical or virtual network devices are installed on the server.
- To use Ethernet devices as ports of the team, the physical or virtual Ethernet devices must be installed on the server.
- To use team, bond, or VLAN devices as ports of the team, ensure that these devices are not already configured.

### Procedure

1. Open a terminal, and enter **nm-connection-editor**:

```
$ nm-connection-editor
```

2. Click the **+** button to add a new connection.
3. Select the **Team** connection type, and click **Create**.

4. On the **Team** tab:
  - a. Optional: Set the name of the team interface in the **Interface name** field.
  - b. Click the **Add** button to add a new connection profile for a network interface and adding the profile as a port to the team.
    - i. Select the connection type of the interface. For example, select **Ethernet** for a wired connection.
    - ii. Optional: Set a connection name for the port.
    - iii. If you create a connection profile for an Ethernet device, open the **Ethernet** tab, and select in the **Device** field the network interface you want to add as a port to the team. If you selected a different device type, configure it accordingly. Note that you can only use Ethernet interfaces in a team that are not assigned to any connection.
    - iv. Click **Save**.
  - c. Repeat the previous step for each interface you want to add to the team.

The screenshot shows a dialog box titled "Editing Team connection 1" with a close button (X) in the top right corner. The dialog has a tabbed interface with the following tabs: "General", "Team" (which is selected and highlighted with a blue underline), "Proxy", "IPv4 Settings", and "IPv6 Settings".

Under the "Team" tab, the following fields and controls are visible:

- Connection name:** A text field containing "Team connection 1".
- Interface name:** A text field containing "team0".
- MTU:** A control with a text field containing "automatic", a minus sign button, a plus sign button, and the text "bytes".
- Teamed connections:** A list box containing two entries: "team0-port1" and "team0-port2".
- Buttons:** To the right of the list box are two buttons: "Add" and "Edit".

- d. Click the **Advanced** button to set advanced options to the team connection.
    - i. On the **Runner** tab, select the runner.
    - ii. On the **Link Watcher** tab, set the link watcher and its optional settings.
    - iii. Click **OK**.
5. Configure the IP address settings on both the **IPv4 Settings** and **IPv6 Settings** tabs:
    - To use this bridge device as a port of other devices, set the **Method** field to **Disabled**.
    - To use DHCP, leave the **Method** field at its default, **Automatic (DHCP)**.
    - To use static IP settings, set the **Method** field to **Manual** and fill the fields accordingly:

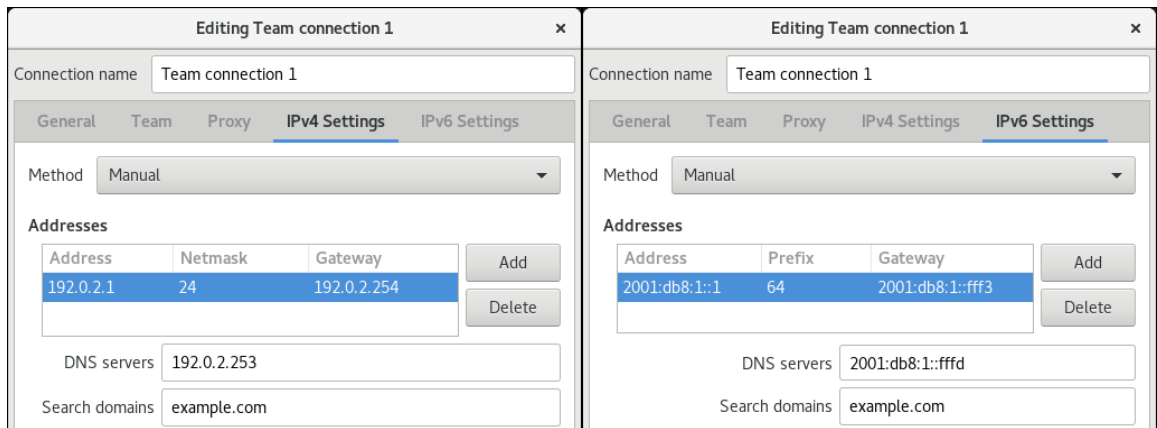

6. Click **Save**.
7. Close **nm-connection-editor**.

## Verification

- Display the status of the team:

```
# teamdctl team0 state
setup:
  runner: activebackup
ports:
  enp7s0
    link watches:
      link summary: up
      instance[link_watch_0]:
        name: ethtool
        link: up
        down count: 0
  enp8s0
    link watches:
      link summary: up
      instance[link_watch_0]:
        name: ethtool
        link: up
        down count: 0
runner:
  active port: enp7s0
```

## Additional resources

- [Configuring a network bond by using nm-connection-editor](#)
- [Configuring a network team by using nm-connection-editor](#)
- [Configuring VLAN tagging by using nm-connection-editor](#)
- [Configuring NetworkManager to avoid using a specific profile to provide a default gateway](#)
- [Understanding the teamd service, runners, and link-watchers](#)
- [NetworkManager duplicates a connection after restart of NetworkManager service](#)



## CHAPTER 5. CONFIGURING VLAN TAGGING

A Virtual Local Area Network (VLAN) is a logical network within a physical network. The VLAN interface tags packets with the VLAN ID as they pass through the interface, and removes tags of returning packets. You create VLAN interfaces on top of another interface, such as Ethernet, bond, team, or bridge devices. These interfaces are called the **parent interface**.

Red Hat Enterprise Linux provides administrators different options to configure VLAN devices. For example:

- Use **nmcli** to configure VLAN tagging using the command line.
- Use the RHEL web console to configure VLAN tagging using a web browser.
- Use **nmtui** to configure VLAN tagging in a text-based user interface.
- Use the **nm-connection-editor** application to configure connections in a graphical interface.
- Use **nmstatectl** to configure connections through the Nmstate API.
- Use RHEL system roles to automate the VLAN configuration on one or multiple hosts.

### 5.1. CONFIGURING VLAN TAGGING BY USING NMCLI

You can configure Virtual Local Area Network (VLAN) tagging on the command line using the **nmcli** utility.

#### Prerequisites

- The interface you plan to use as a parent to the virtual VLAN interface supports VLAN tags.
- If you configure the VLAN on top of a bond interface:
  - The ports of the bond are up.
  - The bond is not configured with the **fail\_over\_mac=follow** option. A VLAN virtual device cannot change its MAC address to match the parent's new MAC address. In such a case, the traffic would still be sent with the incorrect source MAC address.
  - The bond is usually not expected to get IP addresses from a DHCP server or IPv6 auto-configuration. Ensure it by setting the **ipv4.method=disable** and **ipv6.method=ignore** options while creating the bond. Otherwise, if DHCP or IPv6 auto-configuration fails after some time, the interface might be brought down.
- The switch, the host is connected to, is configured to support VLAN tags. For details, see the documentation of your switch.

#### Procedure

1. Display the network interfaces:

```
# nmcli device status
DEVICE TYPE   STATE      CONNECTION
enp1s0  ethernet  disconnected enp1s0
```

```
bridge0 bridge connected bridge0
bond0 bond connected bond0
...
```

2. Create the VLAN interface. For example, to create a VLAN interface named **vlan10** that uses **enp1s0** as its parent interface and that tags packets with VLAN ID **10**, enter:

```
# nmcli connection add type vlan con-name vlan10 ifname vlan10 vlan.parent enp1s0
vlan.id 10
```

Note that the VLAN must be within the range from **0** to **4094**.

3. By default, the VLAN connection inherits the maximum transmission unit (MTU) from the parent interface. Optionally, set a different MTU value:

```
# nmcli connection modify vlan10 ethernet.mtu 2000
```

4. Configure the IPv4 settings:

- To use this VLAN device as a port of other devices, enter:

```
# nmcli connection modify vlan10 ipv4.method disabled
```

- To use DHCP, no action is required.
- To set a static IPv4 address, network mask, default gateway, and DNS server to the **vlan10** connection, enter:

```
# nmcli connection modify vlan10 ipv4.addresses '192.0.2.1/24' ipv4.gateway
'192.0.2.254' ipv4.dns '192.0.2.253' ipv4.method manual
```

5. Configure the IPv6 settings:

- To use this VLAN device as a port of other devices, enter:

```
# nmcli connection modify vlan10 ipv6.method disabled
```

- To use stateless address autoconfiguration (SLAAC), no action is required.
- To set a static IPv6 address, network mask, default gateway, and DNS server to the **vlan10** connection, enter:

```
# nmcli connection modify vlan10 ipv6.addresses '2001:db8:1::1/32' ipv6.gateway
'2001:db8:1::fffe' ipv6.dns '2001:db8:1::fffd' ipv6.method manual
```

6. Activate the connection:

```
# nmcli connection up vlan10
```

## Verification

- Verify the settings:

**# ip -d addr show vlan10**

```

4: vlan10@enp1s0: <BROADCAST,MULTICAST,UP,LOWER_UP> mtu 1500 qdisc noqueue
state UP group default qlen 1000
    link/ether 52:54:00:72:2f:6e brd ff:ff:ff:ff:ff:ff promiscuity 0
    vlan protocol 802.1Q id 10 <REORDER_HDR> numtxqueues 1 numrxqueues 1
gso_max_size 65536 gso_max_segs 65535
    inet 192.0.2.1/24 brd 192.0.2.255 scope global noprefixroute vlan10
        valid_lft forever preferred_lft forever
    inet6 2001:db8:1::1/32 scope global noprefixroute
        valid_lft forever preferred_lft forever
    inet6 fe80::8dd7:9030:6f8e:89e6/64 scope link noprefixroute
        valid_lft forever preferred_lft forever

```

**Additional resources**

- [Configuring NetworkManager to avoid using a specific profile to provide a default gateway](#)
- **nm-settings(5)** man page

**5.2. CONFIGURING VLAN TAGGING BY USING THE RHEL WEB CONSOLE**

Use the RHEL web console to configure VLAN tagging if you prefer to manage network settings using a web browser-based interface.

**Prerequisites**

- The interface you plan to use as a parent to the virtual VLAN interface supports VLAN tags.
- If you configure the VLAN on top of a bond interface:
  - The ports of the bond are up.
  - The bond is not configured with the **fail\_over\_mac=follow** option. A VLAN virtual device cannot change its MAC address to match the parent's new MAC address. In such a case, the traffic would still be sent with the incorrect source MAC address.
  - The bond is usually not expected to get IP addresses from a DHCP server or IPv6 auto-configuration. Ensure it by disabling the IPv4 and IPv6 protocol creating the bond. Otherwise, if DHCP or IPv6 auto-configuration fails after some time, the interface might be brought down.
- The switch, the host is connected to, is configured to support VLAN tags. For details, see the documentation of your switch.

**Procedure**

1. Select the **Networking** tab in the navigation on the left side of the screen.
2. Click **Add VLAN** in the **Interfaces** section.
3. Select the parent device.
4. Enter the VLAN ID.

5. Enter the name of the VLAN device or keep the automatically-generated name.

### VLAN settings ✕

**Parent**

**VLAN ID**

**Name**

6. Click **Apply**.
7. By default, the VLAN device uses a dynamic IP address. If you want to set a static IP address:
  - a. Click the name of the VLAN device in the **Interfaces** section.
  - b. Click **Edit** next to the protocol you want to configure.
  - c. Select **Manual** next to **Addresses**, and enter the IP address, prefix, and default gateway.
  - d. In the **DNS** section, click the **+** button, and enter the IP address of the DNS server. Repeat this step to set multiple DNS servers.
  - e. In the **DNS search domains** section, click the **+** button, and enter the search domain.
  - f. If the interface requires static routes, configure them in the **Routes** section.

### IPv4 settings ✕

Addresses Manual ▾ +

Address	Prefix length or netmask	Gateway	
192.0.2.1	24	192.0.2.254	-

---

DNS  Automatic +

Server 192.0.2.253 -

---

DNS search domains  Automatic +

Search domain example.com -

---

Routes  Automatic +

Apply Cancel

g. Click **Apply**

### Verification

- Select the **Networking** tab in the navigation on the left side of the screen, and check if there is incoming and outgoing traffic on the interface:

Interfaces <span style="float: right;"> <span style="border: 1px solid gray; padding: 2px 5px; margin-right: 5px;">Add bond</span> <span style="border: 1px solid gray; padding: 2px 5px; margin-right: 5px;">Add team</span> <span style="border: 1px solid gray; padding: 2px 5px; margin-right: 5px;">Add bridge</span> <span style="border: 1px solid gray; padding: 2px 5px;">Add VLAN</span> </span>				
Name	IP address	Sending	Receiving	
<span style="color: #007bff;">enp1s0.10</span>	192.0.2.1/24	1.11 Mbps	61.2 Mbps	

## 5.3. CONFIGURING VLAN TAGGING BY USING NMTUI

The **nmtui** application provides a text-based user interface for NetworkManager. You can use **nmtui** to configure VLAN tagging on a host without a graphical interface.



## NOTE

In **nmtui**:

- Navigate by using the cursor keys.
- Press a button by selecting it and hitting **Enter**.
- Select and deselect checkboxes by using **Space**.

## Prerequisites

- The interface you plan to use as a parent to the virtual VLAN interface supports VLAN tags.
- If you configure the VLAN on top of a bond interface:
  - The ports of the bond are up.
  - The bond is not configured with the **fail\_over\_mac=follow** option. A VLAN virtual device cannot change its MAC address to match the parent's new MAC address. In such a case, the traffic would still be sent with the then incorrect source MAC address.
  - The bond is usually not expected to get IP addresses from a DHCP server or IPv6 auto-configuration. Ensure it by setting the **ipv4.method=disable** and **ipv6.method=ignore** options while creating the bond. Otherwise, if DHCP or IPv6 auto-configuration fails after some time, the interface might be brought down.
- The switch the host is connected to is configured to support VLAN tags. For details, see the documentation of your switch.

## Procedure

1. If you do not know the network device name on which you want configure VLAN tagging, display the available devices:

```
# nmcli device status
DEVICE  TYPE    STATE      CONNECTION
enp1s0  ethernet unavailable --
...
```

2. Start **nmtui**:

```
# nmtui
```

3. Select **Edit a connection**, and press **Enter**.
4. Press the **Add** button.
5. Select **VLAN** from the list of network types, and press **Enter**.
6. Optional: Enter a name for the NetworkManager profile to be created.  
On hosts with multiple profiles, a meaningful name makes it easier to identify the purpose of a profile.
7. Enter the VLAN device name to be created into the **Device** field.

8. Enter the name of the device on which you want to configure VLAN tagging into the **Parent** field.
9. Enter the VLAN ID. The ID must be within the range from **0** to **4094**.
10. Depending on your environment, configure the IP address settings in the **IPv4 configuration** and **IPv6 configuration** areas accordingly. For this, press the button next to these areas, and select:
  - **Disabled**, if this VLAN device does not require an IP address or you want to use it as a port of other devices.
  - **Automatic**, if a DHCP server or stateless address autoconfiguration (SLAAC) dynamically assigns an IP address to the VLAN device.
  - **Manual**, if the network requires static IP address settings. In this case, you must fill further fields:
    - i. Press the **Show** button next to the protocol you want to configure to display additional fields.
    - ii. Press the **Add** button next to **Addresses**, and enter the IP address and the subnet mask in Classless Inter-Domain Routing (CIDR) format.  
If you do not specify a subnet mask, NetworkManager sets a **/32** subnet mask for IPv4 addresses and **/64** for IPv6 addresses.
    - iii. Enter the address of the default gateway.
    - iv. Press the **Add** button next to **DNS servers**, and enter the DNS server address.
    - v. Press the **Add** button next to **Search domains**, and enter the DNS search domain.

Figure 5.1. Example of a VLAN connection with static IP address settings

The screenshot shows the 'Edit Connection' window for a connection named 'vlan10'. The window is divided into several sections:

- Profile name:** vlan10
- Device:** vlan10
- VLAN section:**
  - Parent:** enp1s0
  - VLAN id:** 10
  - Cloned MAC address:** (empty)
  - MTU:** (default)
- IPv4 CONFIGURATION <Manual> <Hide>**
  - Addresses:** 192.0.2.1/24 <Remove> <Add...>
  - Gateway:** 192.0.2.254
  - DNS servers:** 192.0.2.253 <Remove> <Add...>
  - Search domains:** <Add...>
  - Routing (No custom routes) <Edit...>**
    - Never use this network for default route
    - Ignore automatically obtained routes
    - Ignore automatically obtained DNS parameters
  - Require IPv4 addressing for this connection
- IPv6 CONFIGURATION <Manual> <Hide>**
  - Addresses:** 2001:db8:1::1/32 <Remove> <Add...>
  - Gateway:** 2001:db8:1::ffff
  - DNS servers:** 2001:db8:1::fffd <Remove> <Add...>
  - Search domains:** <Add...>
  - Routing (No custom routes) <Edit...>**
    - Never use this network for default route
    - Ignore automatically obtained routes
    - Ignore automatically obtained DNS parameters
  - Require IPv6 addressing for this connection
- Automatically connect
- Available to all users

At the bottom right, there are buttons for '<Cancel>' and '<OK>'.

11. Press the **OK** button to create and automatically activate the new connection.
12. Press the **Back** button to return to the main menu.
13. Select **Quit**, and press **Enter** to close the **nmtui** application.

### Verification

- Verify the settings:



```
# ip -d addr show vlan10
4: vlan10@enp1s0: <BROADCAST,MULTICAST,UP,LOWER_UP> mtu 1500 qdisc noqueue
state UP group default qlen 1000
    link/ether 52:54:00:72:2f:6e brd ff:ff:ff:ff:ff:ff promiscuity 0
    vlan protocol 802.1Q id 10 <REORDER_HDR> numtxqueues 1 numrxqueues 1
gso_max_size 65536 gso_max_segs 65535
    inet 192.0.2.1/24 brd 192.0.2.255 scope global noprefixroute vlan10
        valid_lft forever preferred_lft forever
    inet6 2001:db8:1::1/32 scope global noprefixroute
        valid_lft forever preferred_lft forever
    inet6 fe80::8dd7:9030:6f8e:89e6/64 scope link noprefixroute
        valid_lft forever preferred_lft forever
```

## 5.4. CONFIGURING VLAN TAGGING BY USING NM-CONNECTION-EDITOR

You can configure Virtual Local Area Network (VLAN) tagging in a graphical interface using the **nm-connection-editor** application.

### Prerequisites

- The interface you plan to use as a parent to the virtual VLAN interface supports VLAN tags.
- If you configure the VLAN on top of a bond interface:
  - The ports of the bond are up.
  - The bond is not configured with the **fail\_over\_mac=follow** option. A VLAN virtual device cannot change its MAC address to match the parent's new MAC address. In such a case, the traffic would still be sent with the incorrect source MAC address.
- The switch, the host is connected, to is configured to support VLAN tags. For details, see the documentation of your switch.

### Procedure

1. Open a terminal, and enter **nm-connection-editor**:

```
$ nm-connection-editor
```

2. Click the **+** button to add a new connection.
3. Select the **VLAN** connection type, and click **Create**.
4. On the **VLAN** tab:
  - a. Select the parent interface.
  - b. Select the VLAN id. Note that the VLAN must be within the range from **0** to **4094**.
  - c. By default, the VLAN connection inherits the maximum transmission unit (MTU) from the parent interface. Optionally, set a different MTU value.
  - d. Optionally, set the name of the VLAN interface and further VLAN-specific options.

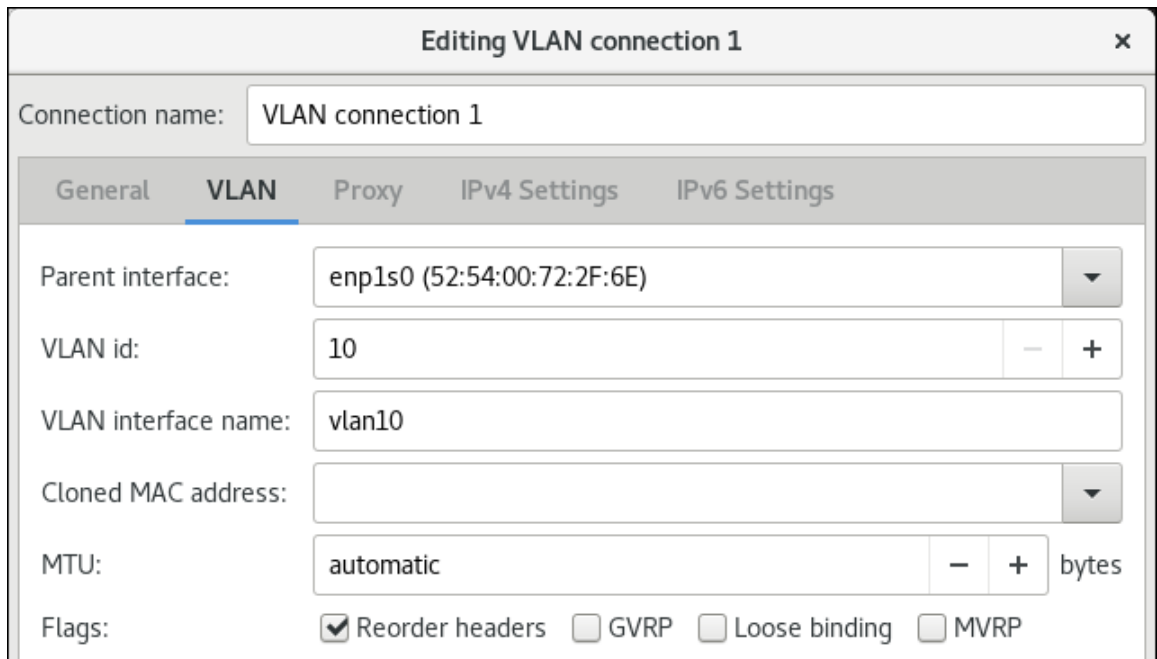

Editing VLAN connection 1

Connection name: VLAN connection 1

General **VLAN** Proxy IPv4 Settings IPv6 Settings

Parent interface: enp1s0 (52:54:00:72:2F:6E)

VLAN id: 10

VLAN interface name: vlan10

Cloned MAC address:

MTU: automatic bytes

Flags:  Reorder headers  GVRP  Loose binding  MVRP

5. Configure the IP address settings on both the **IPv4 Settings** and **IPv6 Settings** tabs:

- To use this bridge device as a port of other devices, set the **Method** field to **Disabled**.
- To use DHCP, leave the **Method** field at its default, **Automatic (DHCP)**.
- To use static IP settings, set the **Method** field to **Manual** and fill the fields accordingly:

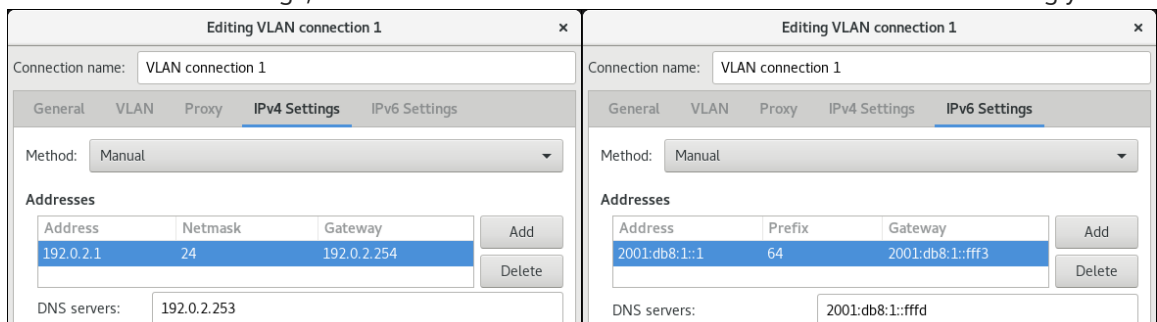

Editing VLAN connection 1

Connection name: VLAN connection 1

General VLAN Proxy **IPv4 Settings** IPv6 Settings

Method: Manual

Addresses

Address	Netmask	Gateway
192.0.2.1	24	192.0.2.254

DNS servers: 192.0.2.253

Editing VLAN connection 1

Connection name: VLAN connection 1

General VLAN Proxy IPv4 Settings **IPv6 Settings**

Method: Manual

Addresses

Address	Prefix	Gateway
2001:db8:1::1	64	2001:db8:1::fff3

DNS servers: 2001:db8:1::ffff

6. Click **Save**.

7. Close **nm-connection-editor**.

## Verification

1. Verify the settings:

```
# ip -d addr show vlan10
4: vlan10@enp1s0: <BROADCAST,MULTICAST,UP,LOWER_UP> mtu 1500 qdisc noqueue
state UP group default qlen 1000
    link/ether 52:54:00:d5:e0:fb brd ff:ff:ff:ff:ff:ff promiscuity 0
    vlan protocol 802.1Q id 10 <REORDER_HDR> numtxqueues 1 numrxqueues 1
gso_max_size 65536 gso_max_segs 65535
    inet 192.0.2.1/24 brd 192.0.2.255 scope global noprefixroute vlan10
        valid_lft forever preferred_lft forever
    inet6 2001:db8:1::1/32 scope global noprefixroute
        valid_lft forever preferred_lft forever
    inet6 fe80::8dd7:9030:6f8e:89e6/64 scope link noprefixroute
        valid_lft forever preferred_lft forever
```

-

### Additional resources

- [Configuring NetworkManager to avoid using a specific profile to provide a default gateway](#)

## 5.5. CONFIGURING VLAN TAGGING BY USING NMSTATECTL

Use the **nmstatectl** utility to configure Virtual Local Area Network VLAN through the Nmstate API. The Nmstate API ensures that, after setting the configuration, the result matches the configuration file. If anything fails, **nmstatectl** automatically rolls back the changes to avoid leaving the system in an incorrect state.

Depending on your environment, adjust the YAML file accordingly. For example, to use different devices than Ethernet adapters in the VLAN, adapt the **base-iface** attribute and **type** attributes of the ports you use in the VLAN.

### Prerequisites

- To use Ethernet devices as ports in the VLAN, the physical or virtual Ethernet devices must be installed on the server.
- The **nmstate** package is installed.

### Procedure

1. Create a YAML file, for example **~/create-vlan.yml**, with the following content:

```
---
interfaces:
- name: vlan10
  type: vlan
  state: up
  ipv4:
    enabled: true
    address:
    - ip: 192.0.2.1
      prefix-length: 24
    dhcp: false
  ipv6:
    enabled: true
    address:
    - ip: 2001:db8:1::1
      prefix-length: 64
    autoconf: false
    dhcp: false
  vlan:
    base-iface: enp1s0
    id: 10
- name: enp1s0
  type: ethernet
  state: up

routes:
  config:
  - destination: 0.0.0.0/0
```

```

next-hop-address: 192.0.2.254
next-hop-interface: vlan10
- destination: ::0
next-hop-address: 2001:db8:1::fffe
next-hop-interface: vlan10

```

```

dns-resolver:
config:
search:
- example.com
server:
- 192.0.2.200
- 2001:db8:1::ffbb

```

These settings define a VLAN with ID 10 that uses the **enp1s0** device. As the child device, the VLAN connection has the following settings:

- A static IPv4 address - **192.0.2.1** with the **/24** subnet mask
- A static IPv6 address - **2001:db8:1::1** with the **/64** subnet mask
- An IPv4 default gateway - **192.0.2.254**
- An IPv6 default gateway - **2001:db8:1::fffe**
- An IPv4 DNS server - **192.0.2.200**
- An IPv6 DNS server - **2001:db8:1::ffbb**
- A DNS search domain - **example.com**

2. Apply the settings to the system:

```
# nmstatectl apply ~/create-vlan.yml
```

## Verification

1. Display the status of the devices and connections:

```
# nmcli device status
DEVICE  TYPE  STATE  CONNECTION
vlan10  vlan  connected  vlan10
```

2. Display all settings of the connection profile:

```
# nmcli connection show vlan10
connection.id:      vlan10
connection.uuid:    1722970f-788e-4f81-bd7d-a86bf21c9df5
connection.stable-id:  --
connection.type:    vlan
connection.interface-name:  vlan10
...
```

3. Display the connection settings in YAML format:

```
# nmstatectl show vlan0
```

### Additional resources

- **nmstatectl(8)** man page
- `/usr/share/doc/nmstate/examples/` directory

## 5.6. CONFIGURING VLAN TAGGING BY USING THE NETWORK RHEL SYSTEM ROLE

You can use the **network** RHEL system role to configure VLAN tagging. This example adds an Ethernet connection and a VLAN with ID **10** on top of this Ethernet connection. As the child device, the VLAN connection contains the IP, default gateway, and DNS configurations.

Depending on your environment, adjust the play accordingly. For example:

- To use the VLAN as a port in other connections, such as a bond, omit the **ip** attribute, and set the IP configuration in the child configuration.
- To use team, bridge, or bond devices in the VLAN, adapt the **interface\_name** and **type** attributes of the ports you use in the VLAN.

### Prerequisites

- [You have prepared the control node and the managed nodes](#)
- You are logged in to the control node as a user who can run playbooks on the managed nodes.
- The account you use to connect to the managed nodes has **sudo** permissions on them.

### Procedure

1. Create a playbook file, for example `~/playbook.yml`, with the following content:

```
---
- name: Configure the network
  hosts: managed-node-01.example.com
  tasks:
    - name: Configure a VLAN that uses an Ethernet connection
      ansible.builtin.include_role:
        name: rhel-system-roles.network
      vars:
        network_connections:
          # Add an Ethernet profile for the underlying device of the VLAN
          - name: enp1s0
            type: ethernet
            interface_name: enp1s0
            autoconnect: yes
            state: up
            ip:
              dhcp4: no
              auto6: no
```

```
# Define the VLAN profile
- name: enp1s0.10
  type: vlan
  ip:
    address:
      - "192.0.2.1/24"
      - "2001:db8:1::1/64"
    gateway4: 192.0.2.254
    gateway6: 2001:db8:1::fffe
  dns:
    - 192.0.2.200
    - 2001:db8:1::ffbb
  dns_search:
    - example.com
  vlan_id: 10
  parent: enp1s0
  state: up
```

These settings define a VLAN to operate on top of the **enp1s0** device. The VLAN interface has the following settings:

- A static IPv4 address – **192.0.2.1** with a **/24** subnet mask
- A static IPv6 address – **2001:db8:1::1** with a **/64** subnet mask
- An IPv4 default gateway – **192.0.2.254**
- An IPv6 default gateway – **2001:db8:1::fffe**
- An IPv4 DNS server – **192.0.2.200**
- An IPv6 DNS server – **2001:db8:1::ffbb**
- A DNS search domain – **example.com**
- VLAN ID – **10**

The **parent** attribute in the VLAN profile configures the VLAN to operate on top of the **enp1s0** device. As the child device, the VLAN connection contains the IP, default gateway, and DNS configurations.

2. Validate the playbook syntax:

```
$ ansible-playbook --syntax-check ~/playbook.yml
```

Note that this command only validates the syntax and does not protect against a wrong but valid configuration.

3. Run the playbook:

```
$ ansible-playbook ~/playbook.yml
```

#### Additional resources

- `/usr/share/ansible/roles/rhel-system-roles.network/README.md` file
- `/usr/share/doc/rhel-system-roles/network/` directory

## 5.7. ADDITIONAL RESOURCES

- [VLANs for sysadmins: The basics](#)

## CHAPTER 6. CONFIGURING A NETWORK BRIDGE

A network bridge is a link-layer device which forwards traffic between networks based on a table of MAC addresses. The bridge builds the MAC addresses table by listening to network traffic and thereby learning what hosts are connected to each network. For example, you can use a software bridge on a Red Hat Enterprise Linux host to emulate a hardware bridge or in virtualization environments, to integrate virtual machines (VM) to the same network as the host.

A bridge requires a network device in each network the bridge should connect. When you configure a bridge, the bridge is called **controller** and the devices it uses **ports**.

You can create bridges on different types of devices, such as:

- Physical and virtual Ethernet devices
- Network bonds
- Network teams
- VLAN devices

Due to the IEEE 802.11 standard which specifies the use of 3-address frames in Wi-Fi for the efficient use of airtime, you cannot configure a bridge over Wi-Fi networks operating in Ad-Hoc or Infrastructure modes.

### 6.1. CONFIGURING A NETWORK BRIDGE BY USING NMCLI

To configure a network bridge on the command line, use the **nmcli** utility.

#### Prerequisites

- Two or more physical or virtual network devices are installed on the server.
- To use Ethernet devices as ports of the bridge, the physical or virtual Ethernet devices must be installed on the server.
- To use team, bond, or VLAN devices as ports of the bridge, you can either create these devices while you create the bridge or you can create them in advance as described in:
  - [Configuring a network team by using nmcli](#)
  - [Configuring a network bond by using nmcli](#)
  - [Configuring VLAN tagging by using nmcli](#)

#### Procedure

1. Create a bridge interface:

```
# nmcli connection add type bridge con-name bridge0 ifname bridge0
```

This command creates a bridge named **bridge0**, enter:

2. Display the network interfaces, and note the names of the interfaces you want to add to the bridge:
  -



```
# nmcli device status
DEVICE TYPE STATE CONNECTION
enp7s0 ethernet disconnected --
enp8s0 ethernet disconnected --
bond0 bond connected bond0
bond1 bond connected bond1
...
```

In this example:

- **enp7s0** and **enp8s0** are not configured. To use these devices as ports, add connection profiles in the next step.
- **bond0** and **bond1** have existing connection profiles. To use these devices as ports, modify their profiles in the next step.

### 3. Assign the interfaces to the bridge.

- If the interfaces you want to assign to the bridge are not configured, create new connection profiles for them:

```
# nmcli connection add type ethernet slave-type bridge con-name bridge0-port1
ifname enp7s0 master bridge0
# nmcli connection add type ethernet slave-type bridge con-name bridge0-port2
ifname enp8s0 master bridge0
```

These commands create profiles for **enp7s0** and **enp8s0**, and add them to the **bridge0** connection.

- If you want to assign an existing connection profile to the bridge:
  - Set the **master** parameter of these connections to **bridge0**:

```
# nmcli connection modify bond0 master bridge0
# nmcli connection modify bond1 master bridge0
```

These commands assign the existing connection profiles named **bond0** and **bond1** to the **bridge0** connection.

- Reactivate the connections:

```
# nmcli connection up bond0
# nmcli connection up bond1
```

### 4. Configure the IPv4 settings:

- To use this bridge device as a port of other devices, enter:

```
# nmcli connection modify bridge0 ipv4.method disabled
```

- To use DHCP, no action is required.
- To set a static IPv4 address, network mask, default gateway, and DNS server to the **bridge0** connection, enter:

```
# nmcli connection modify bridge0 ipv4.addresses '192.0.2.1/24' ipv4.gateway
'192.0.2.254' ipv4.dns '192.0.2.253' ipv4.dns-search 'example.com' ipv4.method
manual
```

5. Configure the IPv6 settings:

- To use this bridge device as a port of other devices, enter:

```
# nmcli connection modify bridge0 ipv6.method disabled
```

- To use stateless address autoconfiguration (SLAAC), no action is required.
- To set a static IPv6 address, network mask, default gateway, and DNS server to the **bridge0** connection, enter:

```
# nmcli connection modify bridge0 ipv6.addresses '2001:db8:1::1/64' ipv6.gateway
'2001:db8:1::ffe' ipv6.dns '2001:db8:1::fffd' ipv6.dns-search 'example.com'
ipv6.method manual
```

6. Optional: Configure further properties of the bridge. For example, to set the Spanning Tree Protocol (STP) priority of **bridge0** to **16384**, enter:

```
# nmcli connection modify bridge0 bridge.priority '16384'
```

By default, STP is enabled.

7. Activate the connection:

```
# nmcli connection up bridge0
```

8. Verify that the ports are connected, and the **CONNECTION** column displays the port's connection name:

```
# nmcli device
DEVICE TYPE STATE CONNECTION
...
enp7s0 ethernet connected bridge0-port1
enp8s0 ethernet connected bridge0-port2
```

When you activate any port of the connection, NetworkManager also activates the bridge, but not the other ports of it. You can configure that Red Hat Enterprise Linux enables all ports automatically when the bridge is enabled:

- Enable the **connection.autoconnect-slaves** parameter of the bridge connection:

```
# nmcli connection modify bridge0 connection.autoconnect-slaves 1
```

- Reactivate the bridge:

```
# nmcli connection up bridge0
```

## Verification

- Use the **ip** utility to display the link status of Ethernet devices that are ports of a specific bridge:

```
# ip link show master bridge0
```

```
3: enp7s0: <BROADCAST,MULTICAST,UP,LOWER_UP> mtu 1500 qdisc fq_codel master
bridge0 state UP mode DEFAULT group default qlen 1000
    link/ether 52:54:00:62:61:0e brd ff:ff:ff:ff:ff:ff
4: enp8s0: <BROADCAST,MULTICAST,UP,LOWER_UP> mtu 1500 qdisc fq_codel master
bridge0 state UP mode DEFAULT group default qlen 1000
    link/ether 52:54:00:9e:f1:ce brd ff:ff:ff:ff:ff:ff
```

- Use the **bridge** utility to display the status of Ethernet devices that are ports of any bridge device:

```
# bridge link show
```

```
3: enp7s0: <BROADCAST,MULTICAST,UP,LOWER_UP> mtu 1500 master bridge0 state
forwarding priority 32 cost 100
4: enp8s0: <BROADCAST,MULTICAST,UP,LOWER_UP> mtu 1500 master bridge0 state
listening priority 32 cost 100
5: enp9s0: <BROADCAST,MULTICAST,UP,LOWER_UP> mtu 1500 master bridge1 state
forwarding priority 32 cost 100
6: enp11s0: <BROADCAST,MULTICAST,UP,LOWER_UP> mtu 1500 master bridge1 state
blocking priority 32 cost 100
...
```

To display the status for a specific Ethernet device, use the **bridge link show dev *ethernet\_device\_name*** command.

### Additional resources

- [Configuring NetworkManager to avoid using a specific profile to provide a default gateway](#)
- **nm-settings(5)** man page
- **bridge(8)** man page
- [NetworkManager duplicates a connection after restart of NetworkManager service](#)
- [How to configure a bridge with VLAN information?](#)

## 6.2. CONFIGURING A NETWORK BRIDGE BY USING THE RHEL WEB CONSOLE

Use the RHEL web console to configure a network bridge if you prefer to manage network settings using a web browser-based interface.

### Prerequisites

- Two or more physical or virtual network devices are installed on the server.
- To use Ethernet devices as ports of the bridge, the physical or virtual Ethernet devices must be installed on the server.
- To use team, bond, or VLAN devices as ports of the bridge, you can either create these devices while you create the bridge or you can create them in advance as described in:

- [Configuring a network team using the RHEL web console](#)
- [Configuring a network bond by using the RHEL web console](#)
- [Configuring VLAN tagging by using the RHEL web console](#)

## Procedure

1. Select the **Networking** tab in the navigation on the left side of the screen.
2. Click **Add bridge** in the **Interfaces** section.
3. Enter the name of the bridge device you want to create.
4. Select the interfaces that should be ports of the bridge.
5. Optional: Enable the **Spanning tree protocol (STP)** feature to avoid bridge loops and broadcast radiation.

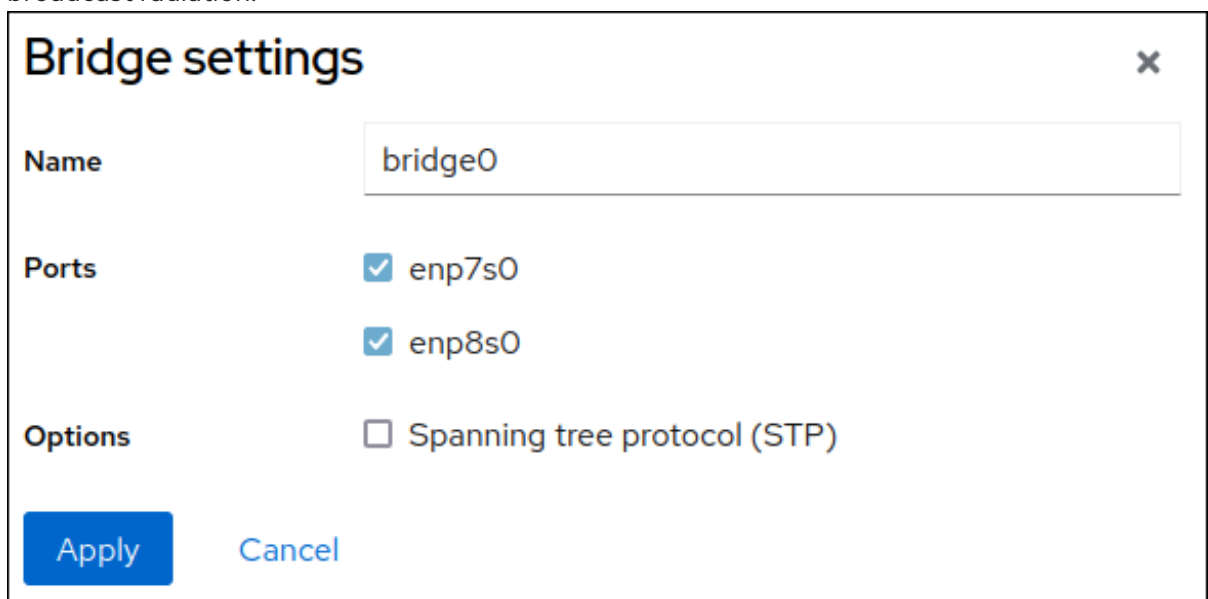

**Bridge settings** ✕

**Name**

**Ports**

- enp7s0
- enp8s0

**Options**

- Spanning tree protocol (STP)

**Apply** **Cancel**

6. Click **Apply**.
7. By default, the bridge uses a dynamic IP address. If you want to set a static IP address:
  - a. Click the name of the bridge in the **Interfaces** section.
  - b. Click **Edit** next to the protocol you want to configure.
  - c. Select **Manual** next to **Addresses**, and enter the IP address, prefix, and default gateway.
  - d. In the **DNS** section, click the **+** button, and enter the IP address of the DNS server. Repeat this step to set multiple DNS servers.
  - e. In the **DNS search domains** section, click the **+** button, and enter the search domain.
  - f. If the interface requires static routes, configure them in the **Routes** section.

### IPv4 settings ✕

Addresses Manual ▾ +

Address	Prefix length or netmask	Gateway	
192.0.2.1	24	192.0.2.254	-

---

DNS  Automatic +

Server -

192.0.2.253

---

DNS search domains  Automatic +

Search domain -

example.com

---

Routes  Automatic +

Apply
Cancel

g. Click **Apply**

### Verification

1. Select the **Networking** tab in the navigation on the left side of the screen, and check if there is incoming and outgoing traffic on the interface:

Interfaces <span style="float: right;"> <span style="border: 1px solid gray; padding: 2px 5px; margin-right: 5px;">Add bond</span> <span style="border: 1px solid gray; padding: 2px 5px; margin-right: 5px;">Add team</span> <span style="border: 1px solid gray; padding: 2px 5px; margin-right: 5px;">Add bridge</span> <span style="border: 1px solid gray; padding: 2px 5px;">Add VLAN</span> </span>				
Name	IP address	Sending	Receiving	
<span style="color: #007bff;">bridge0</span>	192.0.2.1/24	1.11 Mbps	61.2 Mbps	

## 6.3. CONFIGURING A NETWORK BRIDGE BY USING NMTUI

The **nmtui** application provides a text-based user interface for NetworkManager. You can use **nmtui** to configure a network bridge on a host without a graphical interface.



## NOTE

In **nmtui**:

- Navigate by using the cursor keys.
- Press a button by selecting it and hitting **Enter**.
- Select and deselect checkboxes by using **Space**.

## Prerequisites

- Two or more physical or virtual network devices are installed on the server.
- To use Ethernet devices as ports of the bridge, the physical or virtual Ethernet devices must be installed on the server.

## Procedure

1. If you do not know the network device names on which you want configure a network bridge, display the available devices:

```
# nmcli device status
DEVICE  TYPE    STATE      CONNECTION
enp7s0  ethernet unavailable --
enp8s0  ethernet unavailable --
...
```

2. Start **nmtui**:

```
# nmtui
```

3. Select **Edit a connection**, and press **Enter**.
4. Press the **Add** button.
5. Select **Bridge** from the list of network types, and press **Enter**.
6. Optional: Enter a name for the NetworkManager profile to be created.  
On hosts with multiple profiles, a meaningful name makes it easier to identify the purpose of a profile.
7. Enter the bridge device name to be created into the **Device** field.
8. Add ports to the bridge to be created:
  - a. Press the **Add** button next to the **Slaves** list.
  - b. Select the type of the interface you want to add as port to the bridge, for example, **Ethernet**.
  - c. Optional: Enter a name for the NetworkManager profile to be created for this bridge port.
  - d. Enter the port's device name into the **Device** field.
  - e. Press the **OK** button to return to the window with the bridge settings.

Figure 6.1. Adding an Ethernet device as port to a bridge

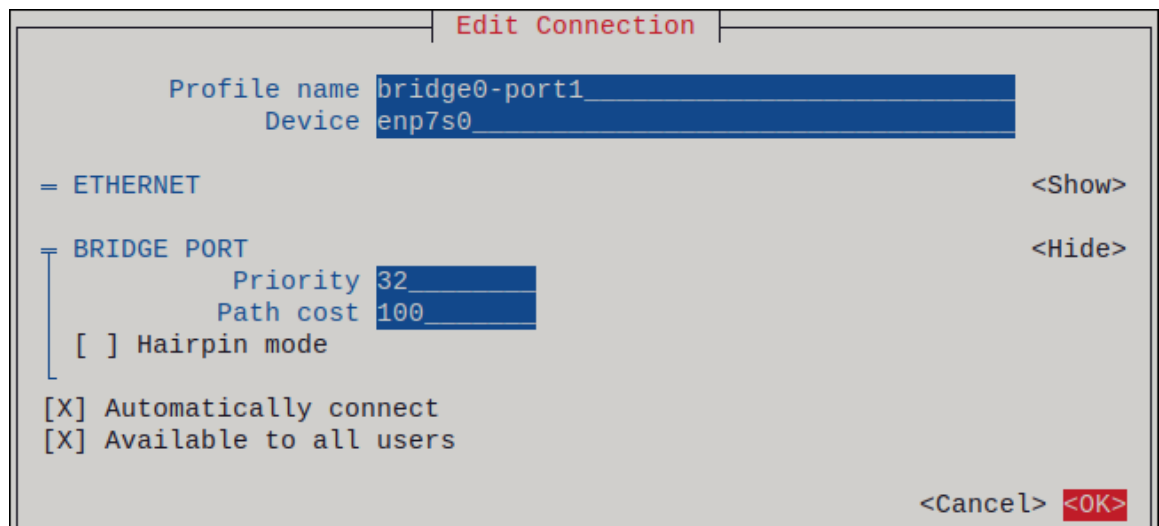

- f. Repeat these steps to add more ports to the bridge.
9. Depending on your environment, configure the IP address settings in the **IPv4 configuration** and **IPv6 configuration** areas accordingly. For this, press the button next to these areas, and select:
    - **Disabled**, if the bridge does not require an IP address.
    - **Automatic**, if a DHCP server or stateless address autoconfiguration (SLAAC) dynamically assigns an IP address to the bridge.
    - **Manual**, if the network requires static IP address settings. In this case, you must fill further fields:
      - i. Press the **Show** button next to the protocol you want to configure to display additional fields.
      - ii. Press the **Add** button next to **Addresses**, and enter the IP address and the subnet mask in Classless Inter-Domain Routing (CIDR) format.  
If you do not specify a subnet mask, NetworkManager sets a **/32** subnet mask for IPv4 addresses and **/64** for IPv6 addresses.
      - iii. Enter the address of the default gateway.
      - iv. Press the **Add** button next to **DNS servers**, and enter the DNS server address.
      - v. Press the **Add** button next to **Search domains**, and enter the DNS search domain.

Figure 6.2. Example of a bridge connection without IP address settings

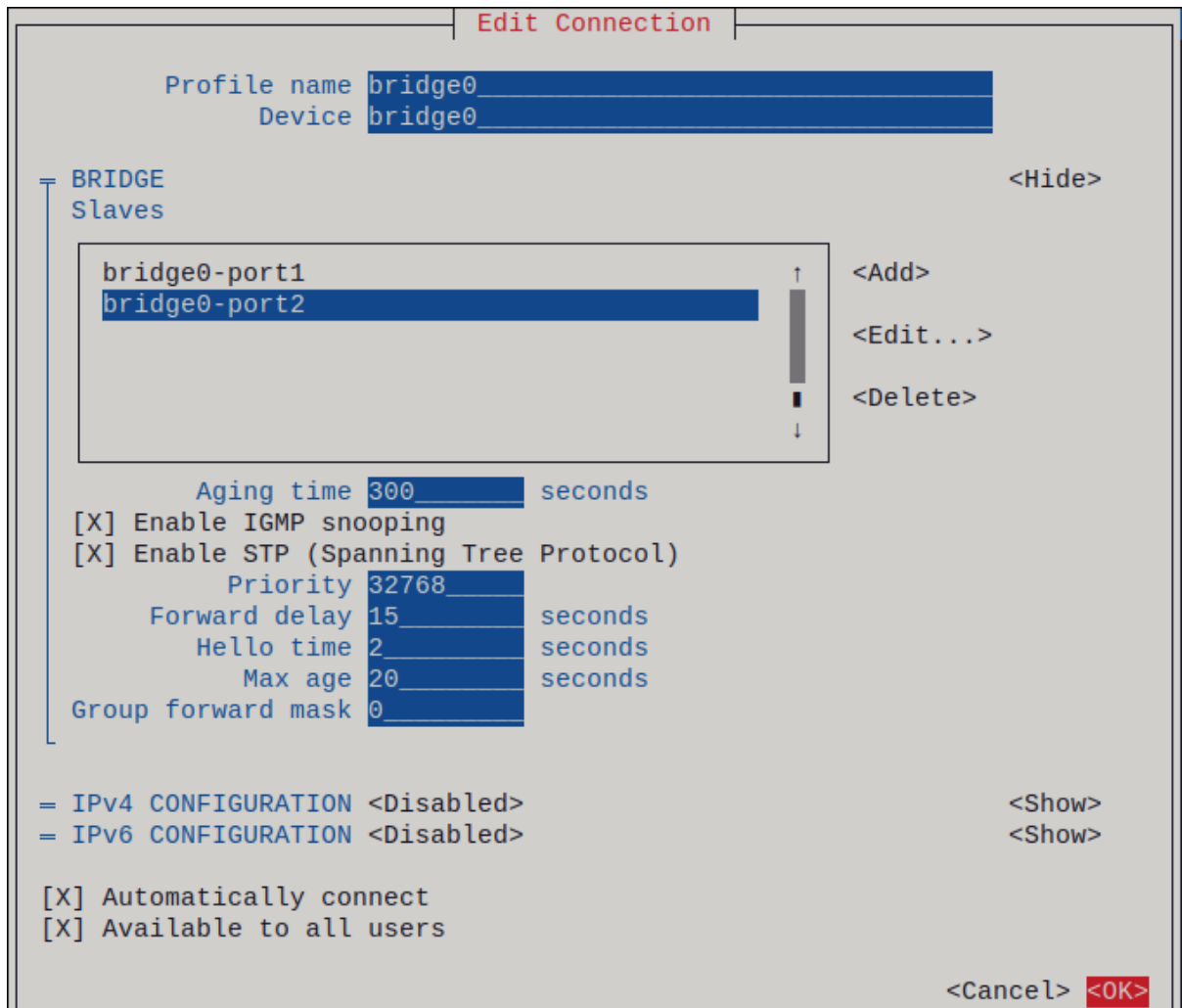

10. Press the **OK** button to create and automatically activate the new connection.
11. Press the **Back** button to return to the main menu.
12. Select **Quit**, and press **Enter** to close the **nmtui** application.

## Verification

1. Use the **ip** utility to display the link status of Ethernet devices that are ports of a specific bridge:

```
# ip link show master bridge0
```

```
3: enp7s0: <BROADCAST,MULTICAST,UP,LOWER_UP> mtu 1500 qdisc fq_codel master
bridge0 state UP mode DEFAULT group default qlen 1000
   link/ether 52:54:00:62:61:0e brd ff:ff:ff:ff:ff:ff
4: enp8s0: <BROADCAST,MULTICAST,UP,LOWER_UP> mtu 1500 qdisc fq_codel master
bridge0 state UP mode DEFAULT group default qlen 1000
   link/ether 52:54:00:9e:f1:ce brd ff:ff:ff:ff:ff:ff
```

2. Use the **bridge** utility to display the status of Ethernet devices that are ports of any bridge device:

```
# bridge link show
```

```
3: enp7s0: <BROADCAST,MULTICAST,UP,LOWER_UP> mtu 1500 master bridge0 state
forwarding priority 32 cost 100
```



```
4: enp8s0: <BROADCAST,MULTICAST,UP,LOWER_UP> mtu 1500 master bridge0 state
listening priority 32 cost 100
...
```

To display the status for a specific Ethernet device, use the **bridge link show dev *ethernet\_device\_name*** command.

## 6.4. CONFIGURING A NETWORK BRIDGE BY USING NM-CONNECTION-EDITOR

If you use Red Hat Enterprise Linux with a graphical interface, you can configure network bridges using the **nm-connection-editor** application.

Note that **nm-connection-editor** can add only new ports to a bridge. To use an existing connection profile as a port, create the bridge using the **nmcli** utility as described in [Configuring a network bridge by using nmcli](#).

### Prerequisites

- Two or more physical or virtual network devices are installed on the server.
- To use Ethernet devices as ports of the bridge, the physical or virtual Ethernet devices must be installed on the server.
- To use team, bond, or VLAN devices as ports of the bridge, ensure that these devices are not already configured.

### Procedure

1. Open a terminal, and enter **nm-connection-editor**:

```
$ nm-connection-editor
```

2. Click the **+** button to add a new connection.
3. Select the **Bridge** connection type, and click **Create**.
4. On the **Bridge** tab:
  - a. Optional: Set the name of the bridge interface in the **Interface name** field.
  - b. Click the **Add** button to create a new connection profile for a network interface and adding the profile as a port to the bridge.
    - i. Select the connection type of the interface. For example, select **Ethernet** for a wired connection.
    - ii. Optionally, set a connection name for the port device.
    - iii. If you create a connection profile for an Ethernet device, open the **Ethernet** tab, and select in the **Device** field the network interface you want to add as a port to the bridge. If you selected a different device type, configure it accordingly.
    - iv. Click **Save**.

- c. Repeat the previous step for each interface you want to add to the bridge.

**Editing Bridge connection 1**

Connection name: Bridge connection 1

General **Bridge** Proxy IPv4 Settings IPv6 Settings

Interface name: bridge0

Bridged connections

bridge0-port1	Add
bridge0-port2	

Edit

- Optional: Configure further bridge settings, such as Spanning Tree Protocol (STP) options.
- Configure the IP address settings on both the **IPv4 Settings** and **IPv6 Settings** tabs:
  - To use this bridge device as a port of other devices, set the **Method** field to **Disabled**.
  - To use DHCP, leave the **Method** field at its default, **Automatic (DHCP)**.
  - To use static IP settings, set the **Method** field to **Manual** and fill the fields accordingly:

**Editing Bridge connection 1** (IPv4 Settings)

Connection name: Bridge connection 1

General Bridge Proxy **IPv4 Settings** IPv6 Settings

Method: Manual

Address	Netmask	Gateway
192.0.2.1	24	192.0.2.254

DNS servers: 192.0.2.1  
Search domains: example.com

**Editing Bridge connection 1** (IPv6 Settings)

Connection name: Bridge connection 1

General Bridge Proxy IPv4 Settings **IPv6 Settings**

Method: Manual

Address	Prefix	Gateway
2001:db8:1::1	64	2001:db8:1::fff3

DNS servers: 2001:db8:1::ffff  
Search domains: example.com

- Click **Save**.
- Close **nm-connection-editor**.

## Verification

- Use the **ip** utility to display the link status of Ethernet devices that are ports of a specific bridge.

```
# ip link show master bridge0
```

```
3: enp7s0: <BROADCAST,MULTICAST,UP,LOWER_UP> mtu 1500 qdisc fq_codel master bridge0 state UP mode DEFAULT group default qlen 1000
```

```
link/ether 52:54:00:62:61:0e brd ff:ff:ff:ff:ff:ff
```

```
4: enp8s0: <BROADCAST,MULTICAST,UP,LOWER_UP> mtu 1500 qdisc fq_codel master bridge0 state UP mode DEFAULT group default qlen 1000
```

```
link/ether 52:54:00:9e:f1:ce brd ff:ff:ff:ff:ff:ff
```

- Use the **bridge** utility to display the status of Ethernet devices that are ports in any bridge device:

```
# bridge link show
```

```
3: enp7s0: <BROADCAST,MULTICAST,UP,LOWER_UP> mtu 1500 master bridge0 state
forwarding priority 32 cost 100
4: enp8s0: <BROADCAST,MULTICAST,UP,LOWER_UP> mtu 1500 master bridge0 state
listening priority 32 cost 100
5: enp9s0: <BROADCAST,MULTICAST,UP,LOWER_UP> mtu 1500 master bridge1 state
forwarding priority 32 cost 100
6: enp11s0: <BROADCAST,MULTICAST,UP,LOWER_UP> mtu 1500 master bridge1 state
blocking priority 32 cost 100
...
```

To display the status for a specific Ethernet device, use the **bridge link show dev *ethernet\_device\_name*** command.

### Additional resources

- [Configuring a network bond by using nm-connection-editor](#)
- [Configuring a network team by using nm-connection-editor](#)
- [Configuring VLAN tagging by using nm-connection-editor](#)
- [Configuring NetworkManager to avoid using a specific profile to provide a default gateway](#)
- [How to configure a bridge with VLAN information?](#)

## 6.5. CONFIGURING A NETWORK BRIDGE BY USING NMSTATECTL

Use the **nmstatectl** utility to configure a network bridge through the Nmstate API. The Nmstate API ensures that, after setting the configuration, the result matches the configuration file. If anything fails, **nmstatectl** automatically rolls back the changes to avoid leaving the system in an incorrect state.

Depending on your environment, adjust the YAML file accordingly. For example, to use different devices than Ethernet adapters in the bridge, adapt the **base-iface** attribute and **type** attributes of the ports you use in the bridge.

### Prerequisites

- Two or more physical or virtual network devices are installed on the server.
- To use Ethernet devices as ports in the bridge, the physical or virtual Ethernet devices must be installed on the server.
- To use team, bond, or VLAN devices as ports in the bridge, set the interface name in the **port** list, and define the corresponding interfaces.
- The **nmstate** package is installed.

### Procedure

1. Create a YAML file, for example **~/create-bridge.yml**, with the following content:

```
---
interfaces:
- name: bridge0
  type: linux-bridge
  state: up
  ipv4:
    enabled: true
    address:
      - ip: 192.0.2.1
        prefix-length: 24
    dhcp: false
  ipv6:
    enabled: true
    address:
      - ip: 2001:db8:1::1
        prefix-length: 64
    autoconf: false
    dhcp: false
  bridge:
    options:
      stp:
        enabled: true
    port:
      - name: enp1s0
      - name: enp7s0
- name: enp1s0
  type: ethernet
  state: up
- name: enp7s0
  type: ethernet
  state: up

routes:
  config:
    - destination: 0.0.0.0/0
      next-hop-address: 192.0.2.254
      next-hop-interface: bridge0
    - destination: ::0
      next-hop-address: 2001:db8:1::fffe
      next-hop-interface: bridge0

dns-resolver:
  config:
    search:
      - example.com
    server:
      - 192.0.2.200
      - 2001:db8:1::ffbb
```

These settings define a network bridge with the following settings:

- Network interfaces in the bridge: **enp1s0** and **enp7s0**
- Spanning Tree Protocol (STP): Enabled
- Static IPv4 address: **192.0.2.1** with the **/24** subnet mask

- Static IPv6 address: **2001:db8:1::1** with the **/64** subnet mask
  - IPv4 default gateway: **192.0.2.254**
  - IPv6 default gateway: **2001:db8:1::fffe**
  - IPv4 DNS server: **192.0.2.200**
  - IPv6 DNS server: **2001:db8:1::ffbb**
  - DNS search domain: **example.com**
2. Apply the settings to the system:

```
# nmstatectl apply ~/create-bridge.yml
```

### Verification

1. Display the status of the devices and connections:

```
# nmcli device status
DEVICE  TYPE  STATE  CONNECTION
bridge0 bridge connected bridge0
```

2. Display all settings of the connection profile:

```
# nmcli connection show bridge0
connection.id:      bridge0
connection.uuid:    e2cc9206-75a2-4622-89cf-1252926060a9
connection.stable-id:  --
connection.type:    bridge
connection.interface-name: bridge0
...
```

3. Display the connection settings in YAML format:

```
# nmstatectl show bridge0
```

### Additional resources

- [nmstatectl\(8\)](#) man page
- [/usr/share/doc/nmstate/examples/](#) directory
- [How to configure a bridge with VLAN information?](#)

## 6.6. CONFIGURING A NETWORK BRIDGE BY USING THE NETWORK RHEL SYSTEM ROLE

You can remotely configure a network bridge by using the **network** RHEL system role.

### Prerequisites

- You have prepared the control node and the managed nodes
- You are logged in to the control node as a user who can run playbooks on the managed nodes.
- The account you use to connect to the managed nodes has **sudo** permissions on them.
- Two or more physical or virtual network devices are installed on the server.

## Procedure

1. Create a playbook file, for example `~/playbook.yml`, with the following content:

```
---
- name: Configure the network
  hosts: managed-node-01.example.com
  tasks:
    - name: Configure a network bridge that uses two Ethernet ports
      ansible.builtin.include_role:
        name: rhel-system-roles.network
      vars:
        network_connections:
          # Define the bridge profile
          - name: bridge0
            type: bridge
            interface_name: bridge0
            ip:
              address:
                - "192.0.2.1/24"
                - "2001:db8:1::1/64"
              gateway4: 192.0.2.254
              gateway6: 2001:db8:1::fffe
            dns:
              - 192.0.2.200
              - 2001:db8:1::ffbb
            dns_search:
              - example.com
            state: up

          # Add an Ethernet profile to the bridge
          - name: bridge0-port1
            interface_name: enp7s0
            type: ethernet
            controller: bridge0
            port_type: bridge
            state: up

          # Add a second Ethernet profile to the bridge
          - name: bridge0-port2
            interface_name: enp8s0
            type: ethernet
            controller: bridge0
            port_type: bridge
            state: up
```

These settings define a network bridge with the following settings:

- A static IPv4 address - **192.0.2.1** with a **/24** subnet mask
- A static IPv6 address - **2001:db8:1::1** with a **/64** subnet mask
- An IPv4 default gateway - **192.0.2.254**
- An IPv6 default gateway - **2001:db8:1::ffe**
- An IPv4 DNS server - **192.0.2.200**
- An IPv6 DNS server - **2001:db8:1::ffbb**
- A DNS search domain - **example.com**
- Ports of the bridge - **enp7s0** and **enp8s0**

**NOTE**

Set the IP configuration on the bridge and not on the ports of the Linux bridge.

2. Validate the playbook syntax:

```
$ ansible-playbook --syntax-check ~/playbook.yml
```

Note that this command only validates the syntax and does not protect against a wrong but valid configuration.

3. Run the playbook:

```
$ ansible-playbook ~/playbook.yml
```

**Additional resources**

- **/usr/share/ansible/roles/rhel-system-roles.network/README.md** file
- **/usr/share/doc/rhel-system-roles/network/** directory

## CHAPTER 7. SETTING UP AN IPSEC VPN

A virtual private network (VPN) is a way of connecting to a local network over the internet. **IPsec** provided by **Libreswan** is the preferred method for creating a VPN. **Libreswan** is a user-space **IPsec** implementation for VPN. A VPN enables the communication between your LAN, and another, remote LAN by setting up a tunnel across an intermediate network such as the internet. For security reasons, a VPN tunnel always uses authentication and encryption. For cryptographic operations, **Libreswan** uses the **NSS** library.

### 7.1. CONFIGURING A VPN CONNECTION WITH CONTROL-CENTER

If you use Red Hat Enterprise Linux with a graphical interface, you can configure a VPN connection in the GNOME **control-center**.

#### Prerequisites

- The **NetworkManager-libreswan-gnome** package is installed.

#### Procedure

1. Press the **Super** key, type **Settings**, and press **Enter** to open the **control-center** application.
2. Select the **Network** entry on the left.
3. Click the **+** icon.
4. Select **VPN**.
5. Select the **Identity** menu entry to see the basic configuration options:

#### General

**Gateway** – The name or **IP** address of the remote VPN gateway.

#### Authentication

#### Type

- **IKEv2 (Certificate)**- client is authenticated by certificate. It is more secure (default).
- **IKEv1 (XAUTH)** - client is authenticated by user name and password, or a pre-shared key (PSK).

The following configuration settings are available under the **Advanced** section:



Figure 7.1. Advanced options of a VPN connection

**IPsec Advanced Options** ✕

**Identification**

Domain:

**Security**

Phase1 Algorithms:

Phase2 Algorithms:

Disable PFS

Phase1 Lifetime:

Phase2 Lifetime:

Disable rekeying

**Connectivity**

Remote Network:

narrowing

Enable fragmentation

Enable MOBIKE



## WARNING

When configuring an IPsec-based VPN connection using the **gnome-control-center** application, the **Advanced** dialog displays the configuration, but it does not allow any changes. As a consequence, users cannot change any advanced IPsec options. Use the **nm-connection-editor** or **nmcli** tools instead to perform configuration of the advanced properties.

### Identification

- **Domain** – If required, enter the Domain Name.

### Security

- **Phase1 Algorithms** – corresponds to the **ike** Libreswan parameter – enter the algorithms to be used to authenticate and set up an encrypted channel.
- **Phase2 Algorithms** – corresponds to the **esp** Libreswan parameter – enter the algorithms to be used for the **IPsec** negotiations.  
Check the **Disable PFS** field to turn off Perfect Forward Secrecy (PFS) to ensure compatibility with old servers that do not support PFS.
- **Phase1 Lifetime** – corresponds to the **ikelifetime** Libreswan parameter – how long the key used to encrypt the traffic will be valid.
- **Phase2 Lifetime** – corresponds to the **salifetime** Libreswan parameter – how long a particular instance of a connection should last before expiring.  
Note that the encryption key should be changed from time to time for security reasons.
- **Remote network** – corresponds to the **rightsubnet** Libreswan parameter – the destination private remote network that should be reached through the VPN.  
Check the **narrowing** field to enable narrowing. Note that it is only effective in IKEv2 negotiation.
- **Enable fragmentation** – corresponds to the **fragmentation** Libreswan parameter – whether or not to allow IKE fragmentation. Valid values are **yes** (default) or **no**.
- **Enable Mobike** – corresponds to the **mobike** Libreswan parameter – whether to allow Mobility and Multihoming Protocol (MOBIKE, RFC 4555) to enable a connection to migrate its endpoint without needing to restart the connection from scratch. This is used on mobile devices that switch between wired, wireless, or mobile data connections. The values are **no** (default) or **yes**.

6. Select the **IPv4** menu entry:

### IPv4 Method

- **Automatic (DHCP)** – Choose this option if the network you are connecting to uses a **DHCP** server to assign dynamic **IP** addresses.
- **Link-Local Only** – Choose this option if the network you are connecting to does not have a **DHCP** server and you do not want to assign **IP** addresses manually. Random addresses will be assigned as per [RFC 3927](#) with prefix **169.254/16**.

- **Manual** – Choose this option if you want to assign **IP** addresses manually.
- **Disable** – **IPv4** is disabled for this connection.  
**DNS**

In the **DNS** section, when **Automatic** is **ON**, switch it to **OFF** to enter the IP address of a DNS server you want to use separating the IPs by comma.

#### Routes

Note that in the **Routes** section, when **Automatic** is **ON**, routes from DHCP are used, but you can also add additional static routes. When **OFF**, only static routes are used.

- **Address** – Enter the **IP** address of a remote network or host.
- **Netmask** – The netmask or prefix length of the **IP** address entered above.
- **Gateway** – The **IP** address of the gateway leading to the remote network or host entered above.
- **Metric** – A network cost, a preference value to give to this route. Lower values will be preferred over higher values.

#### Use this connection only for resources on its network

Select this check box to prevent the connection from becoming the default route. Selecting this option means that only traffic specifically destined for routes learned automatically over the connection or entered here manually is routed over the connection.

7. To configure **IPv6** settings in a **VPN** connection, select the **IPv6** menu entry:

#### IPv6 Method

- **Automatic** – Choose this option to use **IPv6** Stateless Address AutoConfiguration (SLAAC) to create an automatic, stateless configuration based on the hardware address and Router Advertisements (RA).
- **Automatic, DHCP only** – Choose this option to not use RA, but request information from **DHCPv6** directly to create a stateful configuration.
- **Link-Local Only** – Choose this option if the network you are connecting to does not have a **DHCP** server and you do not want to assign **IP** addresses manually. Random addresses will be assigned as per [RFC 4862](#) with prefix **FE80::0**.
- **Manual** – Choose this option if you want to assign **IP** addresses manually.
- **Disable** – **IPv6** is disabled for this connection.

Note that **DNS**, **Routes**, **Use this connection only for resources on its network** are common to **IPv4** settings.

8. Once you have finished editing the **VPN** connection, click the **Add** button to customize the configuration or the **Apply** button to save it for the existing one.
9. Switch the profile to **ON** to active the **VPN** connection.

#### Additional resources

- **nm-settings-libreswan(5)**

## 7.2. CONFIGURING A VPN CONNECTION USING NM-CONNECTION-EDITOR

If you use Red Hat Enterprise Linux with a graphical interface, you can configure a VPN connection in the **nm-connection-editor** application.

### Prerequisites

- The **NetworkManager-libreswan-gnome** package is installed.
- If you configure an Internet Key Exchange version 2 (IKEv2) connection:
  - The certificate is imported into the IPsec network security services (NSS) database.
  - The nickname of the certificate in the NSS database is known.

### Procedure

1. Open a terminal, and enter:

```
$ nm-connection-editor
```

2. Click the **+** button to add a new connection.
3. Select the **IPsec based VPN** connection type, and click **Create**.
4. On the **VPN** tab:
  - a. Enter the host name or IP address of the VPN gateway into the **Gateway** field, and select an authentication type. Based on the authentication type, you must enter different additional information:
    - **IKEv2 (Certificate)** authenticates the client by using a certificate, which is more secure. This setting requires the nickname of the certificate in the IPsec NSS database
    - **IKEv1 (XAUTH)** authenticates the user by using a user name and password (pre-shared key). This setting requires that you enter the following values:
      - User name
      - Password
      - Group name
      - Secret
  - b. If the remote server specifies a local identifier for the IKE exchange, enter the exact string in the **Remote ID** field. In the remote server runs Libreswan, this value is set in the server's **leftid** parameter.

**Editing VPN connection 1** ✕

Connection name:

General    **VPN**    Proxy    IPv4 Settings

**General**

Gateway:

**Authentication**

Type:

Certificate name:

Remote ID:

**Advanced...**

- c. Optionally, configure additional settings by clicking the **Advanced** button. You can configure the following settings:
- Identification
    - **Domain** – If required, enter the domain name.
  - Security
    - **Phase1 Algorithms** corresponds to the **ike** Libreswan parameter. Enter the algorithms to be used to authenticate and set up an encrypted channel.
    - **Phase2 Algorithms** corresponds to the **esp** Libreswan parameter. Enter the algorithms to be used for the **IPsec** negotiations. Check the **Disable PFS** field to turn off Perfect Forward Secrecy (PFS) to ensure compatibility with old servers that do not support PFS.
    - **Phase1 Lifetime** corresponds to the **ikelifetime** Libreswan parameter. This parameter defines how long the key used to encrypt the traffic is valid.
    - **Phase2 Lifetime** corresponds to the **salifetime** Libreswan parameter. This parameter defines how long a security association is valid.
  - Connectivity

- **Remote network** corresponds to the **rightsubnet** Libreswan parameter and defines the destination private remote network that should be reached through the VPN.  
Check the **narrowing** field to enable narrowing. Note that it is only effective in the IKEv2 negotiation.
  - **Enable fragmentation** corresponds to the **fragmentation** Libreswan parameter and defines whether or not to allow IKE fragmentation. Valid values are **yes** (default) or **no**.
  - **Enable Mobike** corresponds to the **mobike** Libreswan parameter. The parameter defines whether to allow Mobility and Multihoming Protocol (MOBIKE) (RFC 4555) to enable a connection to migrate its endpoint without needing to restart the connection from scratch. This is used on mobile devices that switch between wired, wireless or mobile data connections. The values are **no** (default) or **yes**.
5. On the **IPv4 Settings** tab, select the IP assignment method and, optionally, set additional static addresses, DNS servers, search domains, and routes.

The screenshot shows a window titled "Editing VPN connection 1" with a close button (X) in the top right corner. The "Connection name:" field contains "VPN connection 1". Below this are four tabs: "General", "VPN", "Proxy", and "IPv4 Settings", with "IPv4 Settings" being the active tab. Under "Method:", a dropdown menu shows "Automatic (VPN)". Below that is a section titled "Additional static addresses" containing a table with three columns: "Address", "Netmask", and "Gateway". To the right of the table are "Add" and "Delete" buttons. Below the table are two input fields: "Additional DNS servers:" and "Additional search domains:". At the bottom right is a "Routes..." button.

6. Save the connection.
7. Close **nm-connection-editor**.

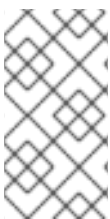

## NOTE

When you add a new connection by clicking the **+** button, **NetworkManager** creates a new configuration file for that connection and then opens the same dialog that is used for editing an existing connection. The difference between these dialogs is that an existing connection profile has a **Details** menu entry.

## Additional resources

- **nm-settings-libreswan(5)** man page

## 7.3. CONFIGURING AUTOMATIC DETECTION AND USAGE OF ESP HARDWARE OFFLOAD TO ACCELERATE AN IPSEC CONNECTION

Offloading Encapsulating Security Payload (ESP) to the hardware accelerates IPsec connections over Ethernet. By default, Libreswan detects if hardware supports this feature and, as a result, enables ESP hardware offload. In case that the feature was disabled or explicitly enabled, you can switch back to automatic detection.

### Prerequisites

- The network card supports ESP hardware offload.
- The network driver supports ESP hardware offload.
- The IPsec connection is configured and works.

### Procedure

1. Edit the Libreswan configuration file in the `/etc/ipsec.d/` directory of the connection that should use automatic detection of ESP hardware offload support.
2. Ensure the `nic-offload` parameter is not set in the connection's settings.
3. If you removed `nic-offload`, restart the `ipsec` service:

```
# systemctl restart ipsec
```

### Verification

If the network card supports ESP hardware offload support, following these steps to verify the result:

1. Display the `tx_ipsec` and `rx_ipsec` counters of the Ethernet device the IPsec connection uses:

```
# ethtool -S enp1s0 | egrep "_ipsec"
tx_ipsec: 10
rx_ipsec: 10
```

2. Send traffic through the IPsec tunnel. For example, ping a remote IP address:

```
# ping -c 5 remote_ip_address
```

3. Display the `tx_ipsec` and `rx_ipsec` counters of the Ethernet device again:

```
# ethtool -S enp1s0 | egrep "_ipsec"
tx_ipsec: 15
rx_ipsec: 15
```

If the counter values have increased, ESP hardware offload works.

### Additional resources

- [Configuring a VPN with IPsec](#)

## 7.4. CONFIGURING ESP HARDWARE OFFLOAD ON A BOND TO ACCELERATE AN IPSEC CONNECTION

Offloading Encapsulating Security Payload (ESP) to the hardware accelerates IPsec connections. If you use a network bond for fail-over reasons, the requirements and the procedure to configure ESP hardware offload are different from those using a regular Ethernet device. For example, in this scenario, you enable the offload support on the bond, and the kernel applies the settings to the ports of the bond.

### Prerequisites

- All network cards in the bond support ESP hardware offload.
- The network driver supports ESP hardware offload on a bond device. In RHEL, only the **ixgbe** driver supports this feature.
- The bond is configured and works.
- The bond uses the **active-backup** mode. The bonding driver does not support any other modes for this feature.
- The IPsec connection is configured and works.

### Procedure

1. Enable ESP hardware offload support on the network bond:

```
# nmcli connection modify bond0 ethtool.feature-esp-hw-offload on
```

This command enables ESP hardware offload support on the **bond0** connection.

2. Reactivate the **bond0** connection:

```
# nmcli connection up bond0
```

3. Edit the Libreswan configuration file in the **/etc/ipsec.d/** directory of the connection that should use ESP hardware offload, and append the **nic-offload=yes** statement to the connection entry:

```
conn example
...
nic-offload=yes
```

4. Restart the **ipsec** service:

```
# systemctl restart ipsec
```

### Verification

1. Display the active port of the bond:

```
# grep "Currently Active Slave" /proc/net/bonding/bond0
Currently Active Slave: enp1s0
```

2. Display the **tx\_ipsec** and **rx\_ipsec** counters of the active port:

-



```
# ethtool -S enp1s0 | egrep "_ipsec"  
tx_ipsec: 10  
rx_ipsec: 10
```

3. Send traffic through the IPsec tunnel. For example, ping a remote IP address:

```
# ping -c 5 remote_ip_address
```

4. Display the **tx\_ipsec** and **rx\_ipsec** counters of the active port again:

```
# ethtool -S enp1s0 | egrep "_ipsec"  
tx_ipsec: 15  
rx_ipsec: 15
```

If the counter values have increased, ESP hardware offload works.

### Additional resources

- [Configuring network bonding](#)
- [Configuring a VPN with IPsec](#) section in the Securing networks document

## CHAPTER 8. CONFIGURING IP TUNNELS

Similar to a VPN, an IP tunnel directly connects two networks over a third network, such as the internet. However, not all tunnel protocols support encryption.

The routers in both networks that establish the tunnel requires at least two interfaces:

- One interface that is connected to the local network
- One interface that is connected to the network through which the tunnel is established.

To establish the tunnel, you create a virtual interface on both routers with an IP address from the remote subnet.

NetworkManager supports the following IP tunnels:

- Generic Routing Encapsulation (GRE)
- Generic Routing Encapsulation over IPv6 (IP6GRE)
- Generic Routing Encapsulation Terminal Access Point (GRETAP)
- Generic Routing Encapsulation Terminal Access Point over IPv6 (IP6GRETAP)
- IPv4 over IPv4 (IPIP)
- IPv4 over IPv6 (IPIP6)
- IPv6 over IPv6 (IP6IP6)
- Simple Internet Transition (SIT)

Depending on the type, these tunnels act either on layer 2 or 3 of the Open Systems Interconnection (OSI) model.

### 8.1. CONFIGURING AN IPIP TUNNEL USING NMCLI TO ENCAPSULATE IPV4 TRAFFIC IN IPV4 PACKETS

An IP over IP (IPIP) tunnel operates on OSI layer 3 and encapsulates IPv4 traffic in IPv4 packets as described in [RFC 2003](#).



#### IMPORTANT

Data sent through an IPIP tunnel is not encrypted. For security reasons, use the tunnel only for data that is already encrypted, for example, by other protocols, such as HTTPS.

Note that IPIP tunnels support only unicast packets. If you require an IPv4 tunnel that supports multicast, see [Configuring a GRE tunnel using nmcli to encapsulate layer-3 traffic in IPv4 packets](#).

For example, you can create an IPIP tunnel between two RHEL routers to connect two internal subnets over the internet as shown in the following diagram:

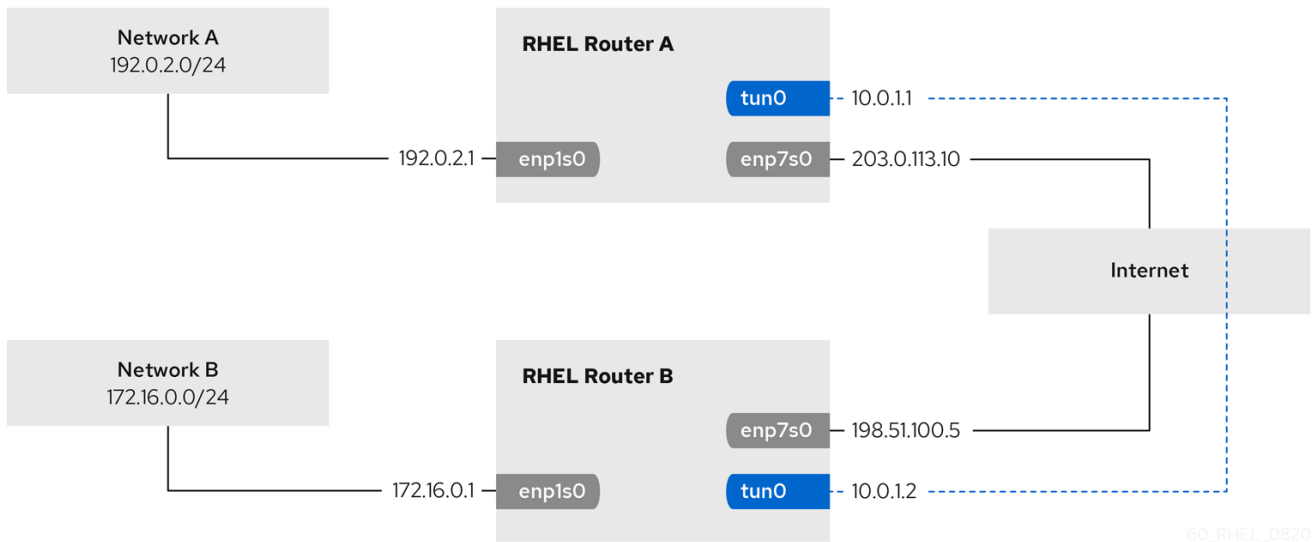

60\_RHEL\_0820

## Prerequisites

- Each RHEL router has a network interface that is connected to its local subnet.
- Each RHEL router has a network interface that is connected to the internet.
- The traffic you want to send through the tunnel is IPv4 unicast.

## Procedure

1. On the RHEL router in network A:
  - a. Create an IPIP tunnel interface named **tun0**:

```
# nmcli connection add type ip-tunnel ip-tunnel.mode ipip con-name tun0 ifname
tun0 remote 198.51.100.5 local 203.0.113.10
```

The **remote** and **local** parameters set the public IP addresses of the remote and the local routers.

- b. Set the IPv4 address to the **tun0** device:

```
# nmcli connection modify tun0 ipv4.addresses '10.0.1.1/30'
```

Note that a **/30** subnet with two usable IP addresses is sufficient for the tunnel.

- c. Configure the **tun0** connection to use a manual IPv4 configuration:

```
# nmcli connection modify tun0 ipv4.method manual
```

- d. Add a static route that routes traffic to the **172.16.0.0/24** network to the tunnel IP on router B:

```
# nmcli connection modify tun0 +ipv4.routes "172.16.0.0/24 10.0.1.2"
```

- e. Enable the **tun0** connection.

```
# nmcli connection up tun0
```

- f. Enable packet forwarding:

```
# echo "net.ipv4.ip_forward=1" > /etc/sysctl.d/95-IPv4-forwarding.conf  
# sysctl -p /etc/sysctl.d/95-IPv4-forwarding.conf
```

2. On the RHEL router in network B:

- a. Create an IPIP tunnel interface named **tun0**:

```
# nmcli connection add type ip-tunnel ip-tunnel.mode ipip con-name tun0 ifname  
tun0 remote 203.0.113.10 local 198.51.100.5
```

The **remote** and **local** parameters set the public IP addresses of the remote and local routers.

- b. Set the IPv4 address to the **tun0** device:

```
# nmcli connection modify tun0 ipv4.addresses '10.0.1.2/30'
```

- c. Configure the **tun0** connection to use a manual IPv4 configuration:

```
# nmcli connection modify tun0 ipv4.method manual
```

- d. Add a static route that routes traffic to the **192.0.2.0/24** network to the tunnel IP on router A:

```
# nmcli connection modify tun0 +ipv4.routes "192.0.2.0/24 10.0.1.1"
```

- e. Enable the **tun0** connection.

```
# nmcli connection up tun0
```

- f. Enable packet forwarding:

```
# echo "net.ipv4.ip_forward=1" > /etc/sysctl.d/95-IPv4-forwarding.conf  
# sysctl -p /etc/sysctl.d/95-IPv4-forwarding.conf
```

## Verification

- From each RHEL router, ping the IP address of the internal interface of the other router:

- a. On Router A, ping **172.16.0.1**:

```
# ping 172.16.0.1
```

- b. On Router B, ping **192.0.2.1**:

```
# ping 192.0.2.1
```

## Additional resources

- `nmcli(1)` man page
- `nm-settings(5)` man page

## 8.2. CONFIGURING A GRE TUNNEL USING NMCLI TO ENCAPSULATE LAYER-3 TRAFFIC IN IPV4 PACKETS

A Generic Routing Encapsulation (GRE) tunnel encapsulates layer-3 traffic in IPv4 packets as described in [RFC 2784](#). A GRE tunnel can encapsulate any layer 3 protocol with a valid Ethernet type.



### IMPORTANT

Data sent through a GRE tunnel is not encrypted. For security reasons, use the tunnel only for data that is already encrypted, for example, by other protocols, such as HTTPS.

For example, you can create a GRE tunnel between two RHEL routers to connect two internal subnets over the internet as shown in the following diagram:

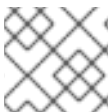
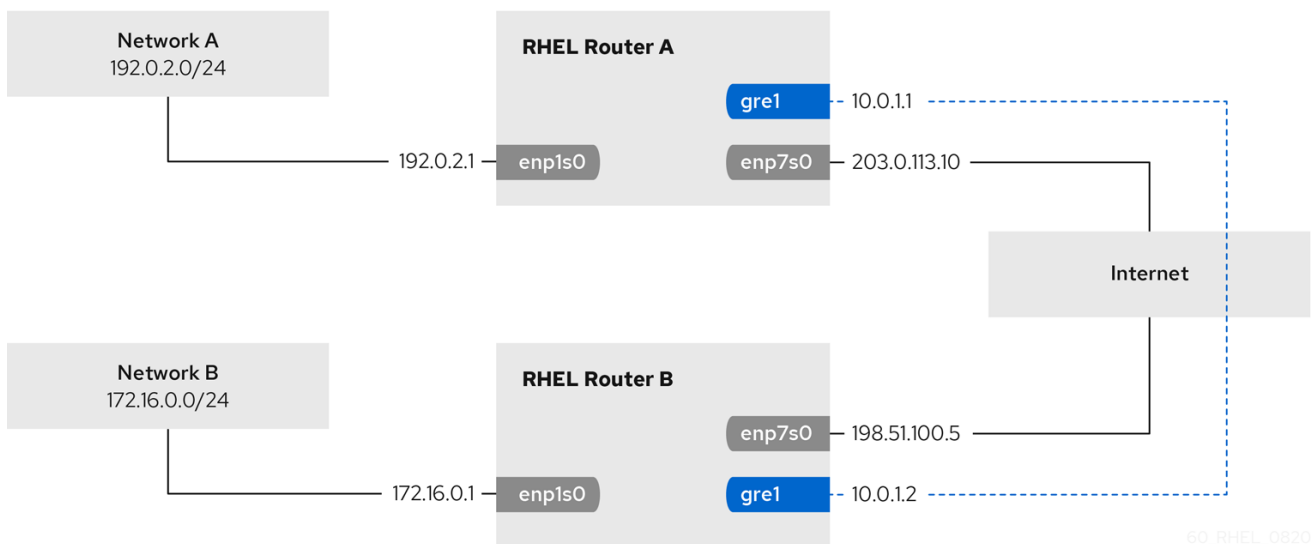

### NOTE

The `gre0` device name is reserved. Use `gre1` or a different name for the device.

### Prerequisites

- Each RHEL router has a network interface that is connected to its local subnet.
- Each RHEL router has a network interface that is connected to the internet.

### Procedure

1. On the RHEL router in network A:
  - a. Create a GRE tunnel interface named `gre1`:

```
# nmcli connection add type ip-tunnel ip-tunnel.mode gre con-name gre1 ifname gre1 remote 198.51.100.5 local 203.0.113.10
```

The **remote** and **local** parameters set the public IP addresses of the remote and the local routers.

- b. Set the IPv4 address to the **gre1** device:

```
# nmcli connection modify gre1 ipv4.addresses '10.0.1.1/30'
```

Note that a **/30** subnet with two usable IP addresses is sufficient for the tunnel.

- c. Configure the **gre1** connection to use a manual IPv4 configuration:

```
# nmcli connection modify gre1 ipv4.method manual
```

- d. Add a static route that routes traffic to the **172.16.0.0/24** network to the tunnel IP on router B:

```
# nmcli connection modify gre1 +ipv4.routes "172.16.0.0/24 10.0.1.2"
```

- e. Enable the **gre1** connection.

```
# nmcli connection up gre1
```

- f. Enable packet forwarding:

```
# echo "net.ipv4.ip_forward=1" > /etc/sysctl.d/95-IPv4-forwarding.conf  
# sysctl -p /etc/sysctl.d/95-IPv4-forwarding.conf
```

2. On the RHEL router in network B:

- a. Create a GRE tunnel interface named **gre1**:

```
# nmcli connection add type ip-tunnel ip-tunnel.mode gre con-name gre1 ifname  
gre1 remote 203.0.113.10 local 198.51.100.5
```

The **remote** and **local** parameters set the public IP addresses of the remote and the local routers.

- b. Set the IPv4 address to the **gre1** device:

```
# nmcli connection modify gre1 ipv4.addresses '10.0.1.2/30'
```

- c. Configure the **gre1** connection to use a manual IPv4 configuration:

```
# nmcli connection modify gre1 ipv4.method manual
```

- d. Add a static route that routes traffic to the **192.0.2.0/24** network to the tunnel IP on router A:

```
# nmcli connection modify gre1 +ipv4.routes "192.0.2.0/24 10.0.1.1"
```

- e. Enable the **gre1** connection.

```
# nmcli connection up gre1
```

- f. Enable packet forwarding:

```
# echo "net.ipv4.ip_forward=1" > /etc/sysctl.d/95-IPv4-forwarding.conf
# sysctl -p /etc/sysctl.d/95-IPv4-forwarding.conf
```

### Verification

1. From each RHEL router, ping the IP address of the internal interface of the other router:
  - a. On Router A, ping **172.16.0.1**:

```
# ping 172.16.0.1
```

- b. On Router B, ping **192.0.2.1**:

```
# ping 192.0.2.1
```

### Additional resources

- **nmcli(1)** man page
- **nm-settings(5)** man page

## 8.3. CONFIGURING A GRE TAP TUNNEL TO TRANSFER ETHERNET FRAMES OVER IPV4

A Generic Routing Encapsulation Terminal Access Point (GRE TAP) tunnel operates on OSI level 2 and encapsulates Ethernet traffic in IPv4 packets as described in [RFC 2784](#).



### IMPORTANT

Data sent through a GRE TAP tunnel is not encrypted. For security reasons, establish the tunnel over a VPN or a different encrypted connection.

For example, you can create a GRE TAP tunnel between two RHEL routers to connect two networks using a bridge as shown in the following diagram:

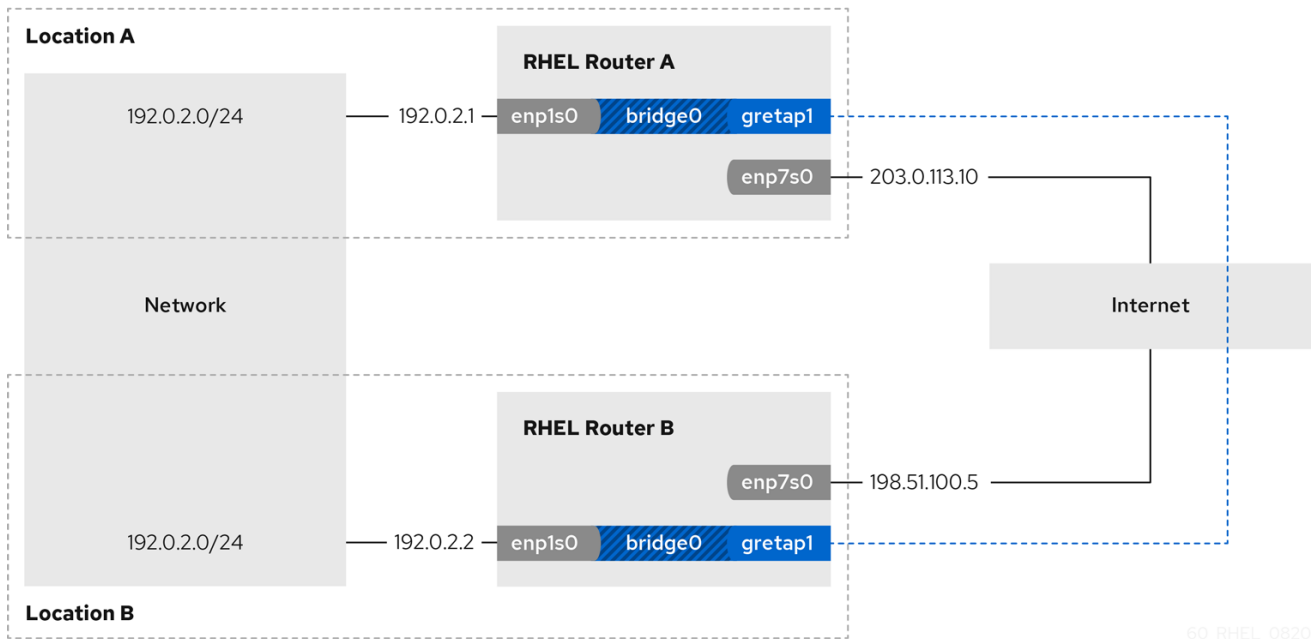

60\_RHEL\_0820



## NOTE

The **gretap0** device name is reserved. Use **gretap1** or a different name for the device.

## Prerequisites

- Each RHEL router has a network interface that is connected to its local network, and the interface has no IP configuration assigned.
- Each RHEL router has a network interface that is connected to the internet.

## Procedure

1. On the RHEL router in network A:

a. Create a bridge interface named **bridge0**:

```
# nmcli connection add type bridge con-name bridge0 ifname bridge0
```

b. Configure the IP settings of the bridge:

```
# nmcli connection modify bridge0 ipv4.addresses '192.0.2.1/24'
# nmcli connection modify bridge0 ipv4.method manual
```

c. Add a new connection profile for the interface that is connected to local network to the bridge:

```
# nmcli connection add type ethernet slave-type bridge con-name bridge0-port1
ifname enp1s0 master bridge0
```

d. Add a new connection profile for the GRETAP tunnel interface to the bridge:



```
# nmcli connection add type ip-tunnel ip-tunnel.mode gretap slave-type bridge
con-name bridge0-port2 ifname gretap1 remote 198.51.100.5 local 203.0.113.10
master bridge0
```

The **remote** and **local** parameters set the public IP addresses of the remote and the local routers.

- e. Optional: Disable the Spanning Tree Protocol (STP) if you do not need it:

```
# nmcli connection modify bridge0 bridge.stp no
```

By default, STP is enabled and causes a delay before you can use the connection.

- f. Configure that activating the **bridge0** connection automatically activates the ports of the bridge:

```
# nmcli connection modify bridge0 connection.autoconnect-slaves 1
```

- g. Active the **bridge0** connection:

```
# nmcli connection up bridge0
```

2. On the RHEL router in network B:

- a. Create a bridge interface named **bridge0**:

```
# nmcli connection add type bridge con-name bridge0 ifname bridge0
```

- b. Configure the IP settings of the bridge:

```
# nmcli connection modify bridge0 ipv4.addresses '192.0.2.2/24'
# nmcli connection modify bridge0 ipv4.method manual
```

- c. Add a new connection profile for the interface that is connected to local network to the bridge:

```
# nmcli connection add type ethernet slave-type bridge con-name bridge0-port1
ifname enp1s0 master bridge0
```

- d. Add a new connection profile for the GRE-TAP tunnel interface to the bridge:

```
# nmcli connection add type ip-tunnel ip-tunnel.mode gretap slave-type bridge
con-name bridge0-port2 ifname gretap1 remote 203.0.113.10 local 198.51.100.5
master bridge0
```

The **remote** and **local** parameters set the public IP addresses of the remote and the local routers.

- e. Optional: Disable the Spanning Tree Protocol (STP) if you do not need it:

```
# nmcli connection modify bridge0 bridge.stp no
```

- f. Configure that activating the **bridge0** connection automatically activates the ports of the bridge:

```
# nmcli connection modify bridge0 connection.autoconnect-slaves 1
```

- g. Active the **bridge0** connection:

```
# nmcli connection up bridge0
```

## Verification

1. On both routers, verify that the **enp1s0** and **gretap1** connections are connected and that the **CONNECTION** column displays the connection name of the port:

```
# nmcli device
nmcli device
DEVICE TYPE STATE CONNECTION
...
bridge0 bridge connected bridge0
enp1s0 ethernet connected bridge0-port1
gretap1 iptunnel connected bridge0-port2
```

2. From each RHEL router, ping the IP address of the internal interface of the other router:
  - a. On Router A, ping **192.0.2.2**:

```
# ping 192.0.2.2
```

- b. On Router B, ping **192.0.2.1**:

```
# ping 192.0.2.1
```

## Additional resources

- [nmcli\(1\)](#) man page
- [nm-settings\(5\)](#) man page

## 8.4. ADDITIONAL RESOURCES

- [ip-link\(8\)](#) man page

## CHAPTER 9. USING A VXLAN TO CREATE A VIRTUAL LAYER-2 DOMAIN FOR VMS

A virtual extensible LAN (VXLAN) is a networking protocol that tunnels layer-2 traffic over an IP network using the UDP protocol. For example, certain virtual machines (VMs), that are running on different hosts can communicate over a VXLAN tunnel. The hosts can be in different subnets or even in different data centers around the world. From the perspective of the VMs, other VMs in the same VXLAN are within the same layer-2 domain:

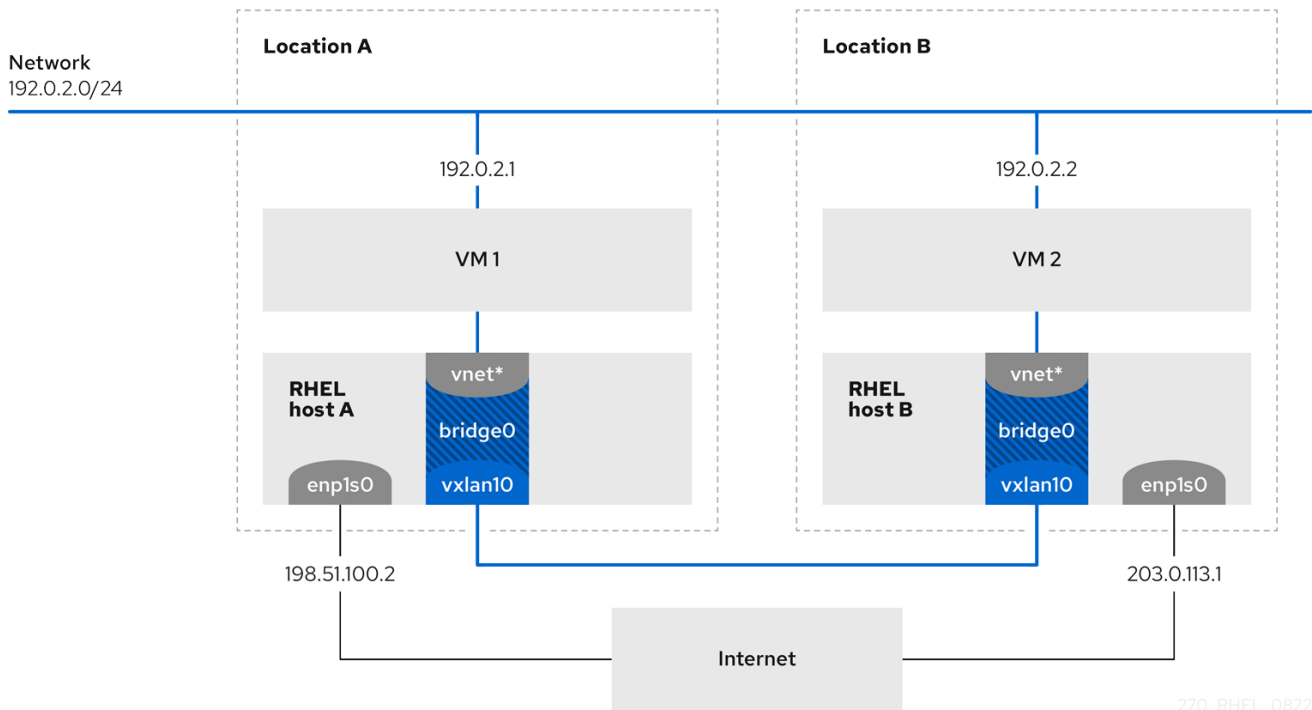

In this example, RHEL-host-A and RHEL-host-B use a bridge, **br0**, to connect the virtual network of a VM on each host with a VXLAN named **vxlan10**. Due to this configuration, the VXLAN is invisible to the VMs, and the VMs do not require any special configuration. If you later connect more VMs to the same virtual network, the VMs are automatically members of the same virtual layer-2 domain.



### IMPORTANT

Just as normal layer-2 traffic, data in a VXLAN is not encrypted. For security reasons, use a VXLAN over a VPN or other types of encrypted connections.

## 9.1. BENEFITS OF VXLANs

A virtual extensible LAN (VXLAN) provides the following major benefits:

- VXLANs use a 24-bit ID. Therefore, you can create up to 16,777,216 isolated networks. For example, a virtual LAN (VLAN), supports only 4,096 isolated networks.
- VXLANs use the IP protocol. This enables you to route the traffic and virtually run systems in different networks and locations within the same layer-2 domain.
- Unlike most tunnel protocols, a VXLAN is not only a point-to-point network. A VXLAN can learn the IP addresses of the other endpoints either dynamically or use statically-configured forwarding entries.

- Certain network cards support UDP tunnel-related offload features.

### Additional resources

- `/usr/share/doc/kernel-doc-<kernel_version>/Documentation/networking/vxlan.rst` provided by the `kernel-doc` package

## 9.2. CONFIGURING THE ETHERNET INTERFACE ON THE HOSTS

To connect a RHEL VM host to the Ethernet, create a network connection profile, configure the IP settings, and activate the profile.

Run this procedure on both RHEL hosts, and adjust the IP address configuration accordingly.

### Prerequisites

- The host is connected to the Ethernet.

### Procedure

1. Add a new Ethernet connection profile to NetworkManager:

```
# nmcli connection add con-name Example ifname enp1s0 type ethernet
```

2. Configure the IPv4 settings:

```
# nmcli connection modify Example ipv4.addresses 198.51.100.2/24 ipv4.method manual ipv4.gateway 198.51.100.254 ipv4.dns 198.51.100.200 ipv4.dns-search example.com
```

Skip this step if the network uses DHCP.

3. Activate the **Example** connection:

```
# nmcli connection up Example
```

### Verification

1. Display the status of the devices and connections:

```
# nmcli device status
DEVICE  TYPE    STATE    CONNECTION
enp1s0  ethernet connected Example
```

2. Ping a host in a remote network to verify the IP settings:

```
# ping RHEL-host-B.example.com
```

Note that you cannot ping the other VM host before you have configured the network on that host as well.

### Additional resources

- **nm-settings(5)** man page

### 9.3. CREATING A NETWORK BRIDGE WITH A VXLAN ATTACHED

To make a virtual extensible LAN (VXLAN) invisible to virtual machines (VMs), create a bridge on a host, and attach the VXLAN to the bridge. Use NetworkManager to create both the bridge and the VXLAN. You do not add any traffic access point (TAP) devices of the VMs, typically named **vnet\*** on the host, to the bridge. The **libvirt** service adds them dynamically when the VMs start.

Run this procedure on both RHEL hosts, and adjust the IP addresses accordingly.

#### Procedure

1. Create the bridge **br0**:

```
# nmcli connection add type bridge con-name br0 ifname br0 ipv4.method disabled
ipv6.method disabled
```

This command sets no IPv4 and IPv6 addresses on the bridge device, because this bridge works on layer 2.

2. Create the VXLAN interface and attach it to **br0**:

```
# nmcli connection add type vxlan slave-type bridge con-name br0-vxlan10 ifname
vxlan10 id 10 local 198.51.100.2 remote 203.0.113.1 master br0
```

This command uses the following settings:

- **id 10**: Sets the VXLAN identifier.
- **local 198.51.100.2**: Sets the source IP address of outgoing packets.
- **remote 203.0.113.1**: Sets the unicast or multicast IP address to use in outgoing packets when the destination link layer address is not known in the VXLAN device forwarding database.
- **master br0**: Sets this VXLAN connection to be created as a port in the **br0** connection.
- **ipv4.method disabled** and **ipv6.method disabled**: Disables IPv4 and IPv6 on the bridge.

By default, NetworkManager uses **8472** as the destination port. If the destination port is different, additionally, pass the **destination-port <port\_number>** option to the command.

3. Activate the **br0** connection profile:

```
# nmcli connection up br0
```

4. Open port **8472** for incoming UDP connections in the local firewall:

```
# firewall-cmd --permanent --add-port=8472/udp
# firewall-cmd --reload
```

#### Verification

- Display the forwarding table:

```
# bridge fdb show dev vxlan10
2a:53:bd:d5:b3:0a master br0 permanent
00:00:00:00:00:00 dst 203.0.113.1 self permanent
...
```

#### Additional resources

- **nm-settings(5)** man page

## 9.4. CREATING A VIRTUAL NETWORK IN LIBVIRT WITH AN EXISTING BRIDGE

To enable virtual machines (VM) to use the **br0** bridge with the attached virtual extensible LAN (VXLAN), first add a virtual network to the **libvirtd** service that uses this bridge.

#### Prerequisites

- You installed the **libvirt** package.
- You started and enabled the **libvirtd** service.
- You configured the **br0** device with the VXLAN on RHEL.

#### Procedure

1. Create the `~/vxlan10-bridge.xml` file with the following content:

```
<network>
  <name>vxlan10-bridge</name>
  <forward mode="bridge" />
  <bridge name="br0" />
</network>
```

2. Use the `~/vxlan10-bridge.xml` file to create a new virtual network in **libvirt**:

```
# virsh net-define ~/vxlan10-bridge.xml
```

3. Remove the `~/vxlan10-bridge.xml` file:

```
# rm ~/vxlan10-bridge.xml
```

4. Start the **vxlan10-bridge** virtual network:

```
# virsh net-start vxlan10-bridge
```

5. Configure the **vxlan10-bridge** virtual network to start automatically when the **libvirtd** service starts:

```
# virsh net-autostart vxlan10-bridge
```

## Verification

- Display the list of virtual networks:

```
# virsh net-list
Name          State  Autostart  Persistent
-----
vxlan10-bridge active  yes       yes
...
```

## Additional resources

- **virsh(1)** man page

## 9.5. CONFIGURING VIRTUAL MACHINES TO USE VXLAN

To configure a VM to use a bridge device with an attached virtual extensible LAN (VXLAN) on the host, create a new VM that uses the **vxlan10-bridge** virtual network or update the settings of existing VMs to use this network.

Perform this procedure on the RHEL hosts.

### Prerequisites

- You configured the **vxlan10-bridge** virtual network in **libvirt**.

### Procedure

- To create a new VM and configure it to use the **vxlan10-bridge** network, pass the **--network network:vxlan10-bridge** option to the **virt-install** command when you create the VM:

```
# virt-install ... --network network:vxlan10-bridge
```

- To change the network settings of an existing VM:
  - a. Connect the VM's network interface to the **vxlan10-bridge** virtual network:

```
# virt-xml VM_name --edit --network network=vxlan10-bridge
```

- b. Shut down the VM, and start it again:

```
# virsh shutdown VM_name
# virsh start VM_name
```

### Verification

1. Display the virtual network interfaces of the VM on the host:

```
# virsh domiflist VM_name
Interface Type  Source          Model  MAC
-----
vnet1    bridge vxlan10-bridge virtio 52:54:00:c5:98:1c
```

2. Display the interfaces attached to the **vxlan10-bridge** bridge:

```
# ip link show master vxlan10-bridge
18: vxlan10: <BROADCAST,MULTICAST,UP,LOWER_UP> mtu 1500 qdisc noqueue master
br0 state UNKNOWN mode DEFAULT group default qlen 1000
    link/ether 2a:53:bd:d5:b3:0a brd ff:ff:ff:ff:ff:ff
19: vnet1: <BROADCAST,MULTICAST,UP,LOWER_UP> mtu 1500 qdisc noqueue master
br0 state UNKNOWN mode DEFAULT group default qlen 1000
    link/ether 52:54:00:c5:98:1c brd ff:ff:ff:ff:ff:ff
```

Note that the **libvirtd** service dynamically updates the bridge's configuration. When you start a VM which uses the **vxlan10-bridge** network, the corresponding **vnet\*** device on the host appears as a port of the bridge.

3. Use address resolution protocol (ARP) requests to verify whether VMs are in the same VXLAN:
  - a. Start two or more VMs in the same VXLAN.
  - b. Send an ARP request from one VM to the other one:

```
# arping -c 1 192.0.2.2
ARPING 192.0.2.2 from 192.0.2.1 enp1s0
Unicast reply from 192.0.2.2 [52:54:00:c5:98:1c] 1.450ms
Sent 1 probe(s) (0 broadcast(s))
Received 1 response(s) (0 request(s), 0 broadcast(s))
```

If the command shows a reply, the VM is in the same layer-2 domain and, in this case in the same VXLAN.

Install the **iputils** package to use the **arping** utility.

### Additional resources

- **virt-install(1)** man page
- **virt-xml(1)** man page
- **virsh(1)** man page
- **arping(8)** man page



## CHAPTER 10. MANAGING WIFI CONNECTIONS

RHEL provides multiple utilities and applications to configure and connect to wifi networks, for example:

- Use the **nmcli** utility to configure connections by using the command line.
- Use the **nmtui** application to configure connections in a text-based user interface.
- Use the GNOME system menu to quickly connect to wifi networks that do not require any configuration.
- Use the **GNOME Settings** application to configure connections by using the GNOME application.
- Use the **nm-connection-editor** application to configure connections in a graphical user interface.
- Use the **network** RHEL system role to automate the configuration of connections on one or multiple hosts.

### 10.1. SUPPORTED WIFI SECURITY TYPES

Depending on the security type a wifi network supports, you can transmitted data more or less securely.



#### WARNING

Do not connect to wifi networks that do not use encryption or which support only the insecure WEP or WPA standards.

RHEL 8 supports the following wifi security types:

- **None:** Encryption is disabled, and data is transferred in plain text over the network.
- **Enhanced Open:** With opportunistic wireless encryption (OWE), devices negotiate unique pairwise master keys (PMK) to encrypt connections in wireless networks without authentication.
- **WEP 40/128-bit Key (Hex or ASCII):** The Wired Equivalent Privacy (WEP) protocol in this mode uses pre-shared keys only in hex or ASCII format. WEP is deprecated and will be removed in RHEL 9.1.
- **WEP 128-bit Passphrase.** The WEP protocol in this mode uses an MD5 hash of the passphrase to derive a WEP key. WEP is deprecated and will be removed in RHEL 9.1.
- **Dynamic WEP (802.1x):** A combination of 802.1X and EAP that uses the WEP protocol with dynamic keys. WEP is deprecated and will be removed in RHEL 9.1.
- **LEAP:** The Lightweight Extensible Authentication Protocol, which was developed by Cisco, is a proprietary version of the extensible authentication protocol (EAP).
- **WPA & WPA2 Personal:** In personal mode, the Wi-Fi Protected Access (WPA) and Wi-Fi Protected Access 2 (WPA2) authentication methods use a pre-shared key.

- **WPA & WPA2 Enterprise:** In enterprise mode, WPA and WPA2 use the EAP framework and authenticate users to a remote authentication dial-in user service (RADIUS) server.
- **WPA3 Personal:** Wi-Fi Protected Access 3 (WPA3) Personal uses simultaneous authentication of equals (SAE) instead of pre-shared keys (PSK) to prevent dictionary attacks. WPA3 uses perfect forward secrecy (PFS).

## 10.2. CONNECTING TO A WIFI NETWORK BY USING NMCLI

You can use the **nmcli** utility to connect to a wifi network. When you attempt to connect to a network for the first time, the utility automatically creates a NetworkManager connection profile for it. If the network requires additional settings, such as static IP addresses, you can then modify the profile after it has been automatically created.

### Prerequisites

- A wifi device is installed on the host.
- The wifi device is enabled, if it has a hardware switch.

### Procedure

1. If the wifi radio has been disabled in NetworkManager, enable this feature:

```
# nmcli radio wifi on
```

2. Optional: Display the available wifi networks:

```
# nmcli device wifi list
IN-USE BSSID      SSID      MODE CHAN RATE      SIGNAL BARS SECURITY
      00:53:00:2F:3B:08 Office    Infra 44  270 Mbit/s 57  ████████ WPA2 WPA3
      00:53:00:15:03:BF --        Infra 1   130 Mbit/s 48  ████████ WPA2 WPA3
```

The service set identifier (**SSID**) column contains the names of the networks. If the column shows **--**, the access point of this network does not broadcast an SSID.

3. Connect to the wifi network:

```
# nmcli device wifi connect Office --ask
Password: wifi-password
```

If you prefer to set the password in the command instead of entering it interactively, use the **password *wifi-password*** option in the command instead of **--ask**:

```
# nmcli device wifi connect Office wifi-password
```

Note that, if the network requires static IP addresses, NetworkManager fails to activate the connection at this point. You can configure the IP addresses in later steps.

4. If the network requires static IP addresses:
  - a. Configure the IPv4 address settings, for example:

```
# nmcli connection modify Office ipv4.method manual ipv4.addresses 192.0.2.1/24
ipv4.gateway 192.0.2.254 ipv4.dns 192.0.2.200 ipv4.dns-search example.com
```

- b. Configure the IPv6 address settings, for example:

```
# nmcli connection modify Office ipv6.method manual ipv6.addresses
2001:db8:1::1/64 ipv6.gateway 2001:db8:1::fffe ipv6.dns 2001:db8:1::ffbb ipv6.dns-
search example.com
```

5. Re-activate the connection:

```
# nmcli connection up Office
```

## Verification

1. Display the active connections:

```
# nmcli connection show --active
NAME ID TYPE DEVICE
Office 2501eb7e-7b16-4dc6-97ef-7cc460139a58 wifi wlp0s20f3
```

If the output lists the wifi connection you have created, the connection is active.

2. Ping a hostname or IP address:

```
# ping -c 3 example.com
```

## Additional resources

- [nm-settings-nmcli\(5\)](#) man page

## 10.3. CONNECTING TO A WIFI NETWORK BY USING THE GNOME SYSTEM MENU

You can use the GNOME system menu to connect to a wifi network. When you connect to a network for the first time, GNOME creates a NetworkManager connection profile for it. If you configure the connection profile to not automatically connect, you can also use the GNOME system menu to manually connect to a wifi network with an existing NetworkManager connection profile.



### NOTE

Using the GNOME system menu to establish a connection to a wifi network for the first time has certain limitations. For example, you can not configure IP address settings. In this case first configure the connections:

- In the [GNOME settings](#) application
- In the [nm-connection-editor](#) application
- Using [nmcli](#) commands

## Prerequisites

- A wifi device is installed on the host.
- The wifi device is enabled, if it has a hardware switch.

### Procedure

1. Open the system menu on the right side of the top bar.
2. Expand the **Wi-Fi Not Connected** entry.
3. Click **Select Network**:

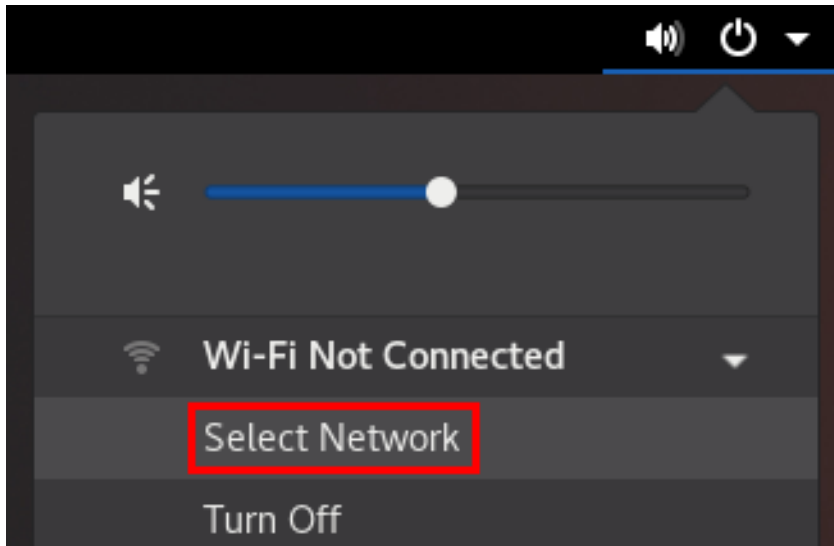

4. Select the wifi network you want to connect to.
5. Click **Connect**.
6. If this is the first time you connect to this network, enter the password for the network, and click **Connect**.

### Verification

1. Open the system menu on the right side of the top bar, and verify that the wifi network is connected:

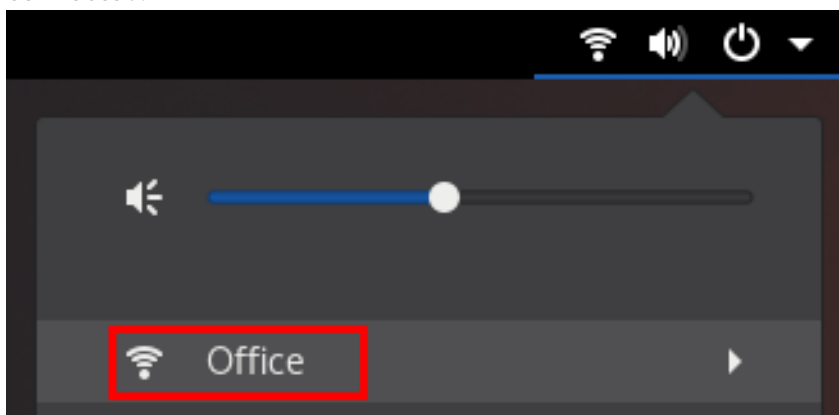

If the network appears in the list, it is connected.

2. Ping a hostname or IP address:

```
# ping -c 3 example.com
```

## 10.4. CONNECTING TO A WIFI NETWORK BY USING THE GNOME SETTINGS APPLICATION

You can use the **GNOME settings** application, also named **gnome-control-center**, to connect to a wifi network and configure the connection. When you connect to the network for the first time, GNOME creates a NetworkManager connection profile for it.

In **GNOME settings**, you can configure wifi connections for all wifi network security types that RHEL supports.

### Prerequisites

- A wifi device is installed on the host.
- The wifi device is enabled, if it has a hardware switch.

### Procedure

1. Press the **Super** key, type **Wi-Fi**, and press **Enter**.
2. Click on the name of the wifi network you want to connect to.
3. Enter the password for the network, and click **Connect**.
4. If the network requires additional settings, such as static IP addresses or a security type other than WPA2 Personal:
  - a. Click the gear icon next to the network's name.
  - b. Optional: Configure the network profile on the **Details** tab to not automatically connect. If you deactivate this feature, you must always manually connect to the network, for example, by using **GNOME settings** or the GNOME system menu.
  - c. Configure IPv4 settings on the **IPv4** tab, and IPv6 settings on the **IPv6** tab.
  - d. On the **Security** tab, select the authentication of the network, such as **WPA3 Personal**, and enter the password.  
Depending on the selected security, the application shows additional fields. Fill them accordingly. For details, ask the administrator of the wifi network.
  - e. Click **Apply**.

### Verification

1. Open the system menu on the right side of the top bar, and verify that the wifi network is connected:

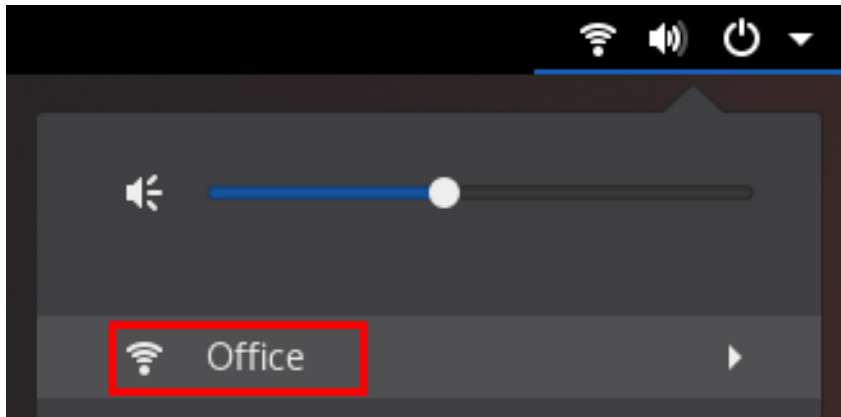

If the network appears in the list, it is connected.

2. Ping a hostname or IP address:

```
# ping -c 3 example.com
```

## 10.5. CONFIGURING A WIFI CONNECTION BY USING NMTUI

The **nmtui** application provides a text-based user interface for NetworkManager. You can use **nmtui** to connect to a wifi network.



### NOTE

In **nmtui**:

- Navigate by using the cursor keys.
- Press a button by selecting it and hitting **Enter**.
- Select and deselect checkboxes by using **Space**.

### Procedure

1. If you do not know the network device name you want to use in the connection, display the available devices:

```
# nmcli device status
DEVICE  TYPE   STATE      CONNECTION
wlp2s0  wifi   unavailable --
...
```

2. Start **nmtui**:

```
# nmtui
```

3. Select **Edit a connection**, and press **Enter**.
4. Press the **Add** button.
5. Select **Wi-Fi** from the list of network types, and press **Enter**.
6. Optional: Enter a name for the NetworkManager profile to be created.

On hosts with multiple profiles, a meaningful name makes it easier to identify the purpose of a profile.

7. Enter the network device name into the **Device** field.
8. Enter the name of the Wi-Fi network, the Service Set Identifier (SSID), into the **SSID** field.
9. Leave the **Mode** field set to its default, **Client**.
10. Select the **Security** field, press **Enter**, and set the authentication type of the network from the list.  
Depending on the authentication type you have selected, **nmtui** displays different fields.
11. Fill the authentication type-related fields.
12. If the Wi-Fi network requires static IP addresses:
  - a. Press the **Automatic** button next to the protocol, and select **Manual** from the displayed list.
  - b. Press the **Show** button next to the protocol you want to configure to display additional fields, and fill them.
13. Press the **OK** button to create and automatically activate the new connection.

The screenshot shows the 'Edit Connection' window in the nmtui application. The window title is 'Edit Connection'. The configuration is as follows:

- Profile name:** Example-Connection
- Device:** wlp2s0
- WI-FI:**
  - SSID:** Example-Wi-Fi
  - Mode:** <Client>
  - Security:** <WPA3 Personal>
  - Password:** \*\*\*\*\*
  - Show password
  - BSSID:** [Redacted]
  - Cloned MAC address:** [Redacted]
  - MTU:** [Redacted] (default)
- IPv4 CONFIGURATION:** <Automatic>
- IPv6 CONFIGURATION:** <Automatic>
- Automatically connect
- Available to all users

At the bottom right, there are buttons for '<Cancel>' and '<OK>'.

14. Press the **Back** button to return to the main menu.
15. Select **Quit**, and press **Enter** to close the **nmtui** application.

## Verification

1. Display the active connections:

```
# nmcli connection show --active
NAME ID TYPE DEVICE
Office 2501eb7e-7b16-4dc6-97ef-7cc460139a58 wifi wlp0s20f3
```

If the output lists the wifi connection you have created, the connection is active.

2. Ping a hostname or IP address:

```
# ping -c 3 example.com
```

## 10.6. CONFIGURING A WIFI CONNECTION BY USING NM-CONNECTION-EDITOR

You can use the **nm-connection-editor** application to create a connection profile for a wireless network. In this application you can configure all wifi network authentication types that RHEL supports.

By default, NetworkManager enables the auto-connect feature for connection profiles and automatically connects to a saved network if it is available.

### Prerequisites

- A wifi device is installed on the host.
- The wifi device is enabled, if it has a hardware switch.

### Procedure

1. Open a terminal and enter:

```
# nm-connection-editor
```

2. Click the **+** button to add a new connection.
3. Select the **Wi-Fi** connection type, and click **Create**.
4. Optional: Set a name for the connection profile.
5. Optional: Configure the network profile on the **General** tab to not automatically connect. If you deactivate this feature, you must always manually connect to the network, for example, by using **GNOME settings** or the GNOME system menu.
6. On the **Wi-Fi** tab, enter the service set identifier (SSID) in the **SSID** field.
7. On the **Wi-Fi Security** tab, select the authentication type for the network, such as **WPA3 Personal**, and enter the password. Depending on the selected security, the application shows additional fields. Fill them accordingly. For details, ask the administrator of the wifi network.
8. Configure IPv4 settings on the **IPv4** tab, and IPv6 settings on the **IPv6** tab.
9. Click **Save**.
10. Close the **Network Connections** window.



## Verification

1. Open the system menu on the right side of the top bar, and verify that the wifi network is connected:

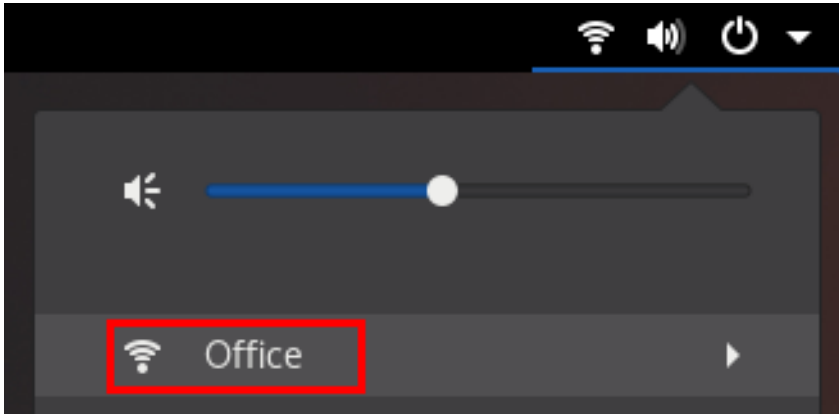

If the network appears in the list, it is connected.

2. Ping a hostname or IP address:

```
# ping -c 3 example.com
```

## 10.7. CONFIGURING A WIFI CONNECTION WITH 802.1X NETWORK AUTHENTICATION BY USING THE NETWORK RHEL SYSTEM ROLE

Using RHEL system role, you can automate the creation of a wifi connection. For example, you can remotely add a wireless connection profile for the **wlp1s0** interface using an Ansible Playbook. The created profile uses the 802.1X standard to authenticate the client to a wifi network. The playbook configures the connection profile to use DHCP. To configure static IP settings, adapt the parameters in the **ip** dictionary accordingly.

### Prerequisites

- You have prepared the control node and the managed nodes
- You are logged in to the control node as a user who can run playbooks on the managed nodes.
- The account you use to connect to the managed nodes has **sudo** permissions on them.
- The network supports 802.1X network authentication.
- You installed the **wpa\_supplicant** package on the managed node.
- DHCP is available in the network of the managed node.
- The following files required for TLS authentication exist on the control node:
  - The client key is stored in the **/srv/data/client.key** file.
  - The client certificate is stored in the **/srv/data/client.crt** file.
  - The CA certificate is stored in the **/srv/data/ca.crt** file.

### Procedure

1. Create a playbook file, for example `~/playbook.yml`, with the following content:

```

---
- name: Configure a wifi connection with 802.1X authentication
  hosts: managed-node-01.example.com
  tasks:
    - name: Copy client key for 802.1X authentication
      ansible.builtin.copy:
        src: "/srv/data/client.key"
        dest: "/etc/pki/tls/private/client.key"
        mode: 0400

    - name: Copy client certificate for 802.1X authentication
      ansible.builtin.copy:
        src: "/srv/data/client.crt"
        dest: "/etc/pki/tls/certs/client.crt"

    - name: Copy CA certificate for 802.1X authentication
      ansible.builtin.copy:
        src: "/srv/data/ca.crt"
        dest: "/etc/pki/ca-trust/source/anchors/ca.crt"

    - block:
      - ansible.builtin.import_role:
          name: rhel-system-roles.network
        vars:
          network_connections:
            - name: Configure the Example-wifi profile
              interface_name: wlp1s0
              state: up
              type: wireless
              autoconnect: yes
              ip:
                dhcp4: true
                auto6: true
              wireless:
                ssid: "Example-wifi"
                key_mgmt: "wpa-eap"
              ieee802_1x:
                identity: "user_name"
                eap: tls
                private_key: "/etc/pki/tls/client.key"
                private_key_password: "password"
                private_key_password_flags: none
                client_cert: "/etc/pki/tls/client.pem"
                ca_cert: "/etc/pki/tls/cacert.pem"
                domain_suffix_match: "example.com"
  
```

These settings define a wifi connection profile for the **wlp1s0** interface. The profile uses 802.1X standard to authenticate the client to the wifi network. The connection retrieves IPv4 addresses, IPv6 addresses, default gateway, routes, DNS servers, and search domains from a DHCP server and IPv6 stateless address autoconfiguration (SLAAC).

2. Validate the playbook syntax:

```
$ ansible-playbook --syntax-check ~/playbook.yml
```

-

Note that this command only validates the syntax and does not protect against a wrong but valid configuration.

3. Run the playbook:

```
$ ansible-playbook ~/playbook.yml
```

#### Additional resources

- `/usr/share/ansible/roles/rhel-system-roles.network/README.md` file
- `/usr/share/doc/rhel-system-roles/network/` directory

## 10.8. CONFIGURING A WIFI CONNECTION WITH 802.1X NETWORK AUTHENTICATION IN AN EXISTING PROFILE BY USING NMCLI

Using the **nmcli** utility, you can configure the client to authenticate itself to the network. For example, you can configure Protected Extensible Authentication Protocol (PEAP) authentication with the Microsoft Challenge-Handshake Authentication Protocol version 2 (MSCHAPv2) in an existing NetworkManager wifi connection profile named **wlp1s0**.

#### Prerequisites

- The network must have 802.1X network authentication.
- The wifi connection profile exists in NetworkManager and has a valid IP configuration.
- If the client is required to verify the certificate of the authenticator, the Certificate Authority (CA) certificate must be stored in the `/etc/pki/ca-trust/source/anchors/` directory.
- The **wpa\_supplicant** package is installed.

#### Procedure

1. Set the wifi security mode to **wpa-eap**, the Extensible Authentication Protocol (EAP) to **peap**, the inner authentication protocol to **mschapv2**, and the user name:

```
# nmcli connection modify wlp1s0 wireless-security.key-mgmt wpa-eap 802-1x.eap
peap 802-1x.phase2-auth mschapv2 802-1x.identity user_name
```

Note that you must set the **wireless-security.key-mgmt**, **802-1x.eap**, **802-1x.phase2-auth**, and **802-1x.identity** parameters in a single command.

2. Optionally, store the password in the configuration:

```
# nmcli connection modify wlp1s0 802-1x.password password
```

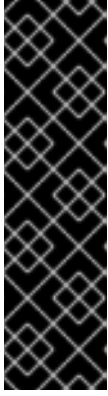

## IMPORTANT

By default, NetworkManager stores the password in plain text in the `/etc/sysconfig/network-scripts/keys-connection_name` file, which is readable only by the **root** user. However, plain text passwords in a configuration file can be a security risk.

To increase the security, set the **802-1x.password-flags** parameter to **0x1**. With this setting, on servers with the GNOME desktop environment or the **nm-applet** running, NetworkManager retrieves the password from these services. In other cases, NetworkManager prompts for the password.

3. If the client needs to verify the certificate of the authenticator, set the **802-1x.ca-cert** parameter in the connection profile to the path of the CA certificate:

```
# nmcli connection modify wlp1s0 802-1x.ca-cert /etc/pki/ca-trust/source/anchors/ca.crt
```



## NOTE

For security reasons, Red Hat recommends the certificate of the authenticator to enable clients to validate the identity of the authenticator.

4. Activate the connection profile:

```
# nmcli connection up wlp1s0
```

## Verification

- Access resources on the network that require network authentication.

## Additional resources

- [Managing wifi connections](#)
- **nm-settings(5)** man page
- **nmcli(1)** man page

## 10.9. MANUALLY SETTING THE WIRELESS REGULATORY DOMAIN

On RHEL, a **udev** rule executes the **setregdomain** utility to set the wireless regulatory domain. The utility then provides this information to the kernel.

By default, **setregdomain** attempts to determine the country code automatically. If this fails, the wireless regulatory domain setting might be wrong. To work around this problem, you can manually set the country code.

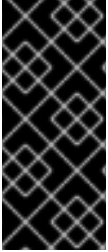

## IMPORTANT

Manually setting the regulatory domain disables the automatic detection. Therefore, if you later use the computer in a different country, the previously configured setting might no longer be correct. In this case, remove the `/etc/sysconfig/regdomain` file to switch back to automatic detection or use this procedure to manually update the regulatory domain setting again.

### Procedure

1. Optional: Display the current regulatory domain settings:

```
# iw reg get
global
country US: DFS-FCC
...
```

2. Create the `/etc/sysconfig/regdomain` file with the following content:

```
COUNTRY=<country_code>
```

Set the **COUNTRY** variable to an ISO 3166-1 alpha2 country code, such as **DE** for Germany or **US** for the United States of America.

3. Set the regulatory domain:

```
# setregdomain
```

### Verification

- Display the regulatory domain settings:

```
# iw reg get
global
country DE: DFS-ETSI
...
```

### Additional resources

- [setregdomain\(1\)](#) man page
- [iw\(8\)](#) man page
- [regulatory.bin\(5\)](#) man page
- [ISO 3166 Country Codes](#)

## CHAPTER 11. CONFIGURING RHEL AS A WPA2 OR WPA3 PERSONAL ACCESS POINT

On a host with a wifi device, you can use NetworkManager to configure this host as an access point. Wi-Fi Protected Access 2 (WPA2) and Wi-Fi Protected Access 3 (WPA3) Personal provide secure authentication methods, and wireless clients can use a pre-shared key (PSK) to connect to the access point and use services on the RHEL host and in the network.

When you configure an access point, NetworkManager automatically:

- Configures the **dnsmasq** service to provide DHCP and DNS services for clients
- Enables IP forwarding
- Adds **nftables** firewall rules to masquerade traffic from the wifi device and configures IP forwarding

### Prerequisites

- The wifi device supports running in access point mode.
- The wifi device is not in use.
- The host has internet access.

### Procedure

1. List the wifi devices to identify the one that should provide the access point:

```
# nmcli device status | grep wifi
wlp0s20f3 wifi disconnected --
```

2. Verify that the device supports the access point mode:

```
# nmcli -f WIFI-PROPERTIES.AP device show wlp0s20f3
WIFI-PROPERTIES.AP: yes
```

To use a wifi device as an access point, the device must support this feature.

3. Install the **dnsmasq** and **NetworkManager-wifi** packages:

```
# yum install dnsmasq NetworkManager-wifi
```

NetworkManager uses the **dnsmasq** service to provide DHCP and DNS services to clients of the access point.

4. Create the initial access point configuration:

```
# nmcli device wifi hotspot ifname wlp0s20f3 con-name Example-Hotspot ssid
Example-Hotspot password "password"
```

This command creates a connection profile for an access point on the **wlp0s20f3** device that provides WPA2 and WPA3 Personal authentication. The name of the wireless network, the Service Set Identifier (SSID), is **Example-Hotspot** and uses the pre-shared key **password**.

- Optional: Configure the access point to support only WPA3:

```
# nmcli connection modify Example-Hotspot 802-11-wireless-security.key-mgmt sae
```

- By default, NetworkManager uses the IP address **10.42.0.1** for the wifi device and assigns IP addresses from the remaining **10.42.0.0/24** subnet to clients. To configure a different subnet and IP address, enter:

```
# nmcli connection modify Example-Hotspot ipv4.addresses 192.0.2.254/24
```

The IP address you set, in this case **192.0.2.254**, is the one that NetworkManager assigns to the wifi device. Clients will use this IP address as default gateway and DNS server.

- Activate the connection profile:

```
# nmcli connection up Example-Hotspot
```

## Verification

- On the server:
  - Verify that NetworkManager started the **dnsmasq** service and that the service listens on port 67 (DHCP) and 53 (DNS):

```
# ss -tulpn | egrep ":53|:67"
udp UNCONN 0 0 10.42.0.1:53 0.0.0.0:* users:(("dnsmasq",pid=55905,fd=6))
udp UNCONN 0 0 0.0.0.0:67 0.0.0.0:* users:(("dnsmasq",pid=55905,fd=4))
tcp LISTEN 0 32 10.42.0.1:53 0.0.0.0:* users:(("dnsmasq",pid=55905,fd=7))
```

- Display the **nftables** rule set to ensure that NetworkManager enabled forwarding and masquerading for traffic from the **10.42.0.0/24** subnet:

```
# nft list ruleset
table ip nm-shared-wlp0s20f3 {
  chain nat_postrouting {
    type nat hook postrouting priority srcnat; policy accept;
    ip saddr 10.42.0.0/24 ip daddr != 10.42.0.0/24 masquerade
  }

  chain filter_forward {
    type filter hook forward priority filter; policy accept;
    ip daddr 10.42.0.0/24 oifname "wlp0s20f3" ct state { established, related } accept
    ip saddr 10.42.0.0/24 iifname "wlp0s20f3" accept
    iifname "wlp0s20f3" oifname "wlp0s20f3" accept
    iifname "wlp0s20f3" reject
    oifname "wlp0s20f3" reject
  }
}
```

- On a client with a wifi adapter:
  - Display the list of available networks:

```
# nmcli device wifi
```

```
IN-USE BSSID      SSID      MODE CHAN RATE  SIGNAL BARS
SECURITY
    00:53:00:88:29:04 Example-Hotspot Infra 11 130 Mbit/s 62  WPA3
...
```

- b. Connect to the **Example-Hotspot** wireless network. See [Managing Wi-Fi connections](#).
- c. Ping a host on the remote network or the internet to verify that the connection works:

```
# ping -c 3 www.redhat.com
```

#### Additional resources

- **nm-settings(5)** man page



## CHAPTER 12. USING MACSEC TO ENCRYPT LAYER-2 TRAFFIC IN THE SAME PHYSICAL NETWORK

You can use MACsec to secure the communication between two devices (point-to-point). For example, your branch office is connected over a Metro-Ethernet connection with the central office, you can configure MACsec on the two hosts that connect the offices to increase the security.

Media Access Control security (MACsec) is a layer 2 protocol that secures different traffic types over the Ethernet links including:

- dynamic host configuration protocol (DHCP)
- address resolution protocol (ARP)
- Internet Protocol version 4 / 6 (**IPv4 / IPv6**) and
- any traffic over IP such as TCP or UDP

MACsec encrypts and authenticates all traffic in LANs, by default with the GCM-AES-128 algorithm, and uses a pre-shared key to establish the connection between the participant hosts. If you want to change the pre-shared key, you need to update the NM configuration on all hosts in the network that uses MACsec.

A MACsec connection uses an Ethernet device, such as an Ethernet network card, VLAN, or tunnel device, as parent. You can either set an IP configuration only on the MACsec device to communicate with other hosts only using the encrypted connection, or you can also set an IP configuration on the parent device. In the latter case, you can use the parent device to communicate with other hosts using an unencrypted connection and the MACsec device for encrypted connections.

MACsec does not require any special hardware. For example, you can use any switch, except if you want to encrypt traffic only between a host and a switch. In this scenario, the switch must also support MACsec.

In other words, there are 2 common methods to configure MACsec;

- host to host and
- host to switch then switch to other host(s)



### IMPORTANT

You can use MACsec only between hosts that are in the same (physical or virtual) LAN.

## 12.1. CONFIGURING A MACSEC CONNECTION USING NMCLI

You can configure Ethernet interfaces to use MACsec using the **nmcli** utility. For example, you can create a MACsec connection between two hosts that are connected over Ethernet.

### Procedure

1. On the first host on which you configure MACsec:
  - Create the connectivity association key (CAK) and connectivity-association key name (CKN) for the pre-shared key:

- a. Create a 16-byte hexadecimal CAK:

```
# dd if=/dev/urandom count=16 bs=1 2> /dev/null | hexdump -e '1/2 "%04x"'
50b71a8ef0bd5751ea76de6d6c98c03a
```

- b. Create a 32-byte hexadecimal CKN:

```
# dd if=/dev/urandom count=32 bs=1 2> /dev/null | hexdump -e '1/2 "%04x"'
f2b4297d39da7330910a74abc0449feb45b5c0b9fc23df1430e1898fcf1c4550
```

2. On both hosts you want to connect over a MACsec connection:
3. Create the MACsec connection:

```
# nmcli connection add type macsec con-name macsec0 ifname macsec0
connection.autoconnect yes macsec.parent enp1s0 macsec.mode psk macsec.mka-
cak 50b71a8ef0bd5751ea76de6d6c98c03a macsec.mka-ckn
f2b4297d39da7330910a74abc0449feb45b5c0b9fc23df1430e1898fcf1c4550
```

Use the CAK and CKN generated in the previous step in the **macsec.mka-cak** and **macsec.mka-ckn** parameters. The values must be the same on every host in the MACsec-protected network.

4. Configure the IP settings on the MACsec connection.
  - a. Configure the **IPv4** settings. For example, to set a static **IPv4** address, network mask, default gateway, and DNS server to the **macsec0** connection, enter:

```
# nmcli connection modify macsec0 ipv4.method manual ipv4.addresses
'192.0.2.1/24' ipv4.gateway '192.0.2.254' ipv4.dns '192.0.2.253'
```

- b. Configure the **IPv6** settings. For example, to set a static **IPv6** address, network mask, default gateway, and DNS server to the **macsec0** connection, enter:

```
# nmcli connection modify macsec0 ipv6.method manual ipv6.addresses
'2001:db8:1::1/32' ipv6.gateway '2001:db8:1::fffe' ipv6.dns '2001:db8:1::fffd'
```

5. Activate the connection:

```
# nmcli connection up macsec0
```

## Verification

1. Verify that the traffic is encrypted:

```
# tcpdump -nn -i enp1s0
```

2. Optional: Display the unencrypted traffic:

```
# tcpdump -nn -i macsec0
```

3. Display MACsec statistics:

█ **# ip macsec show**

4. Display individual counters for each type of protection: integrity-only (encrypt off) and encryption (encrypt on)

█ **# ip -s macsec show**

## 12.2. ADDITIONAL RESOURCES

- [MACsec: a different solution to encrypt network traffic](#) blog.

## CHAPTER 13. GETTING STARTED WITH IPVLAN

IPVLAN is a driver for a virtual network device that can be used in container environment to access the host network. IPVLAN exposes a single MAC address to the external network regardless the number of IPVLAN device created inside the host network. This means that a user can have multiple IPVLAN devices in multiple containers and the corresponding switch reads a single MAC address. IPVLAN driver is useful when the local switch imposes constraints on the total number of MAC addresses that it can manage.

### 13.1. IPVLAN MODES

The following modes are available for IPVLAN:

- L2 mode**  
 In IPVLAN **L2 mode**, virtual devices receive and respond to address resolution protocol (ARP) requests. The **netfilter** framework runs only inside the container that owns the virtual device. No **netfilter** chains are executed in the default namespace on the containerized traffic. Using **L2 mode** provides good performance, but less control on the network traffic.
- L3 mode**  
 In **L3 mode**, virtual devices process only **L3** traffic and above. Virtual devices do not respond to ARP request and users must configure the neighbour entries for the IPVLAN IP addresses on the relevant peers manually. The egress traffic of a relevant container is landed on the **netfilter** POSTROUTING and OUTPUT chains in the default namespace while the ingress traffic is threaded in the same way as **L2 mode**. Using **L3 mode** provides good control but decreases the network traffic performance.
- L3S mode**  
 In **L3S mode**, virtual devices process the same way as in **L3 mode**, except that both egress and ingress traffics of a relevant container are landed on **netfilter** chain in the default namespace. **L3S mode** behaves in a similar way to **L3 mode** but provides greater control of the network.



#### NOTE

The IPVLAN virtual device does not receive broadcast and multicast traffic in case of **L3** and **L3S** modes.

### 13.2. COMPARISON OF IPVLAN AND MACVLAN

The following table shows the major differences between MACVLAN and IPVLAN:

MACVLAN	IPVLAN
<p>Uses MAC address for each MACVLAN device.</p> <p>Note that, if a switch reaches the maximum number of MAC addresses it can store in its MAC table, connectivity can be lost.</p>	<p>Uses single MAC address which does not limit the number of IPVLAN devices.</p>
<p>Netfilter rules for a global namespace cannot affect traffic to or from a MACVLAN device in a child namespace.</p>	<p>It is possible to control traffic to or from a IPVLAN device in <b>L3 mode</b> and <b>L3S mode</b>.</p>

Both IPVLAN and MACVLAN do not require any level of encapsulation.

### 13.3. CREATING AND CONFIGURING THE IPVLAN DEVICE USING IPROUTE2

This procedure shows how to set up the IPVLAN device using **iproute2**.

#### Procedure

1. To create an IPVLAN device, enter the following command:

```
# ip link add link real_NIC_device name IPVLAN_device type ipvlan mode I2
```

Note that network interface controller (NIC) is a hardware component which connects a computer to a network.

#### Example 13.1. Creating an IPVLAN device

```
# ip link add link enp0s31f6 name my_ipvlan type ipvlan mode I2
# ip link
47: my_ipvlan@enp0s31f6: <BROADCAST,MULTICAST> mtu 1500 qdisc noop state
DOWN mode DEFAULT group default qlen 1000 link/ether e8:6a:6e:8a:a2:44 brd
ff:ff:ff:ff:ff:ff
```

2. To assign an **IPv4** or **IPv6** address to the interface, enter the following command:

```
# ip addr add dev IPVLAN_device IP_address/subnet_mask_prefix
```

3. In case of configuring an IPVLAN device in **L3 mode** or **L3S mode**, make the following setups:

- a. Configure the neighbor setup for the remote peer on the remote host:

```
# ip neigh add dev peer_device IPVLAN_device_IP_address lladdr MAC_address
```

where *MAC\_address* is the MAC address of the real NIC on which an IPVLAN device is based on.

- b. Configure an IPVLAN device for **L3 mode** with the following command:

```
# ip route add dev <real_NIC_device> <peer_IP_address/32>
```

For **L3S mode**:

```
# ip route add dev real_NIC_device peer_IP_address/32
```

where IP-address represents the address of the remote peer.

4. To set an IPVLAN device active, enter the following command:

```
# ip link set dev IPVLAN_device up
```

5. To check if the IPVLAN device is active, execute the following command on the remote host:

```
# ping IP_address
```

where the *IP\_address* uses the IP address of the IPVLAN device.

## CHAPTER 14. CONFIGURING NETWORKMANAGER TO IGNORE CERTAIN DEVICES

By default, NetworkManager manages all devices except the loopback (**lo**) device. However, you can configure NetworkManager as **unmanaged** to ignore certain devices. With this setting, you can manually manage these devices, for example, using a script.

### 14.1. PERMANENTLY CONFIGURING A DEVICE AS UNMANAGED IN NETWORKMANAGER

You can permanently configure devices as **unmanaged** based on several criteria, such as the interface name, MAC address, or device type.

To temporarily configure network devices as **unmanaged**, see [Temporarily configuring a device as unmanaged in NetworkManager](#).

#### Procedure

- Optional: Display the list of devices to identify the device or MAC address you want to set as **unmanaged**:

```
# ip link show
...
2: enp1s0: <BROADCAST,MULTICAST,UP,LOWER_UP> mtu 1500 qdisc fq_codel state UP
   mode DEFAULT group default qlen 1000
   link/ether 52:54:00:74:79:56 brd ff:ff:ff:ff:ff:ff
...
```

- Create the `/etc/NetworkManager/conf.d/99-unmanaged-devices.conf` file with the following content:

- To configure a specific interface as unmanaged, add:

```
[keyfile]
unmanaged-devices=interface-name:enp1s0
```

- To configure a device with a specific MAC address as unmanaged, add:

```
[keyfile]
unmanaged-devices=mac:52:54:00:74:79:56
```

- To configure all devices of a specific type as unmanaged, add:

```
[keyfile]
unmanaged-devices=type:ethernet
```

- To set multiple devices as unmanaged, separate the entries in the **unmanaged-devices** parameter with a semicolon, for example:

```
[keyfile]
unmanaged-devices=interface-name:enp1s0;interface-name:enp7s0
```

3. Reload the **NetworkManager** service:

```
# systemctl reload NetworkManager
```

### Verification

- Display the list of devices:

```
# nmcli device status
DEVICE TYPE   STATE   CONNECTION
enp1s0 ethernet unmanaged --
...
```

The **unmanaged** state next to the **enp1s0** device indicates that NetworkManager does not manage this device.

### Troubleshooting

- If the device is not shown as **unmanaged**, display the NetworkManager configuration:

```
# NetworkManager --print-config
...
[keyfile]
unmanaged-devices=interface-name:enp1s0
...
```

If the output does not match the settings that you configured, ensure that no configuration file with a higher priority overrides your settings. For details about how NetworkManager merges multiple configuration files, see the **NetworkManager.conf(5)** man page.

## 14.2. TEMPORARILY CONFIGURING A DEVICE AS UNMANAGED IN NETWORKMANAGER

You can temporarily configure devices as **unmanaged**.

Use this method, for example, for testing purposes. To permanently configure network devices as **unmanaged**, see [Permanently configuring a device as unmanaged in NetworkManager](#) .

### Procedure

1. Optional: Display the list of devices to identify the device you want to set as **unmanaged**:

```
# nmcli device status
DEVICE TYPE   STATE   CONNECTION
enp1s0 ethernet disconnected --
...
```

2. Set the **enp1s0** device to the **unmanaged** state:

```
# nmcli device set enp1s0 managed no
```

### Verification



- Display the list of devices:

```
# nmcli device status
DEVICE TYPE    STATE    CONNECTION
enp1s0 ethernet unmanaged --
...
```

The **unmanaged** state next to the **enp1s0** device indicates that NetworkManager does not manage this device.

#### Additional resources

- **NetworkManager.conf(5)** man page

## CHAPTER 15. CREATING A DUMMY INTERFACE

As a Red Hat Enterprise Linux user, you can create and use dummy network interfaces for debugging and testing purposes. A dummy interface provides a device to route packets without actually transmitting them. It enables you to create additional loopback-like devices managed by NetworkManager and makes an inactive SLIP (Serial Line Internet Protocol) address look like a real address for local programs.

### 15.1. CREATING A DUMMY INTERFACE WITH BOTH AN IPV4 AND IPV6 ADDRESS USING NMCLI

You can create a dummy interface with various settings, such as IPv4 and IPv6 addresses. After creating the interface, NetworkManager automatically assigns it to the default **public firewalld** zone.

#### Procedure

- Create a dummy interface named **dummy0** with static IPv4 and IPv6 addresses:

```
# nmcli connection add type dummy ifname dummy0 ipv4.method manual
ipv4.addresses 192.0.2.1/24 ipv6.method manual ipv6.addresses 2001:db8:2::1/64
```

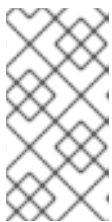

#### NOTE

To configure a dummy interface without IPv4 and IPv6 addresses, set both the **ipv4.method** and **ipv6.method** parameters to **disabled**. Otherwise, IP auto-configuration fails, and NetworkManager deactivates the connection and removes the device.

#### Verification

- List the connection profiles:

```
# nmcli connection show
NAME          UUID                                  TYPE  DEVICE
dummy-dummy0  aaf6eb56-73e5-4746-9037-eed42caa8a65  dummy  dummy0
```

#### Additional resources

- **nm-settings(5)** man page

## CHAPTER 16. USING NETWORKMANAGER TO DISABLE IPV6 FOR A SPECIFIC CONNECTION

On a system that uses NetworkManager to manage network interfaces, you can disable the IPv6 protocol if the network only uses IPv4. If you disable **IPv6**, NetworkManager automatically sets the corresponding **sysctl** values in the Kernel.



### NOTE

If disabling IPv6 using kernel tunables or kernel boot parameters, additional consideration must be given to system configuration. For more information, see the [How do I disable or enable the IPv6 protocol in RHEL?](#) article.

### 16.1. DISABLING IPV6 ON A CONNECTION USING NMCLI

You can use the **nmcli** utility to disable the **IPv6** protocol on the command line.

#### Prerequisites

- The system uses NetworkManager to manage network interfaces.

#### Procedure

1. Optionally, display the list of network connections:

```
# nmcli connection show
NAME UUID TYPE DEVICE
Example 7a7e0151-9c18-4e6f-89ee-65bb2d64d365 ethernet enp1s0
...
```

2. Set the **ipv6.method** parameter of the connection to **disabled**:

```
# nmcli connection modify Example ipv6.method "disabled"
```

3. Restart the network connection:

```
# nmcli connection up Example
```

#### Verification

1. Display the IP settings of the device:

```
# ip address show enp1s0
2: enp1s0: <BROADCAST,MULTICAST,UP,LOWER_UP> mtu 1500 qdisc fq_codel state UP
group default qlen 1000
link/ether 52:54:00:6b:74:be brd ff:ff:ff:ff:ff:ff
inet 192.0.2.1/24 brd 192.10.2.255 scope global noprefixroute enp1s0
valid_lft forever preferred_lft forever
```

If no **inet6** entry is displayed, **IPv6** is disabled on the device.

2. Verify that the `/proc/sys/net/ipv6/conf/enp1s0/disable_ipv6` file now contains the value **1**:

```
# cat /proc/sys/net/ipv6/conf/enp1s0/disable_ipv6  
1
```

The value **1** means that **IPv6** is disabled for the device.

## CHAPTER 17. CHANGING A HOSTNAME

The hostname of a system is the name on the system itself. You can set the name when you install RHEL, and you can change it afterwards.

### 17.1. CHANGING A HOSTNAME USING NMCLI

You can use the **nmcli** utility to update the system hostname. Note that other utilities might use a different term, such as static or persistent hostname.

#### Procedure

1. Optional: Display the current hostname setting:

```
# nmcli general hostname  
old-hostname.example.com
```

2. Set the new hostname:

```
# nmcli general hostname new-hostname.example.com
```

3. NetworkManager automatically restarts the **systemd-hostnamed** to activate the new name. For the changes to take effect, reboot the host:

```
# reboot
```

Alternatively, if you know which services use the hostname:

- a. Restart all services that only read the hostname when the service starts:

```
# systemctl restart <service_name>
```

- b. Active shell users must re-login for the changes to take effect.

#### Verification

- Display the hostname:

```
# nmcli general hostname  
new-hostname.example.com
```

### 17.2. CHANGING A HOSTNAME USING HOSTNAMECTL

You can use the **hostnamectl** utility to update the hostname. By default, this utility sets the following hostname types:

- Static hostname: Stored in the **/etc/hostname** file. Typically, services use this name as the hostname.
- Pretty hostname: A descriptive name, such as **Proxy server in data center A**.
- Transient hostname: A fall-back value that is typically received from the network configuration.

## Procedure

1. Optional: Display the current hostname setting:

```
# hostnamectl status --static  
old-hostname.example.com
```

2. Set the new hostname:

```
# hostnamectl set-hostname new-hostname.example.com
```

This command sets the static, pretty, and transient hostname to the new value. To set only a specific type, pass the **--static**, **--pretty**, or **--transient** option to the command.

3. The **hostnamectl** utility automatically restarts the **systemd-hostnamed** to activate the new name. For the changes to take effect, reboot the host:

```
# reboot
```

Alternatively, if you know which services use the hostname:

- a. Restart all services that only read the hostname when the service starts:

```
# systemctl restart <service_name>
```

- b. Active shell users must re-login for the changes to take effect.

## Verification

- Display the hostname:

```
# hostnamectl status --static  
new-hostname.example.com
```

## Additional resources

- **hostnamectl(1)**
- **systemd-hostnamed.service(8)**

# CHAPTER 18. CONFIGURING NETWORKMANAGER DHCP SETTINGS

NetworkManager provides different configuration options related to DHCP. For example, you can configure NetworkManager to use the build-in DHCP client (default) or an external client, and you can influence DHCP settings of individual profiles.

## 18.1. CHANGING THE DHCP CLIENT OF NETWORKMANAGER

By default, NetworkManager uses its internal DHCP client. However, if you require a DHCP client with features that the built-in client does not provide, you can alternatively configure NetworkManager to use **dhclient**.

Note that RHEL does not provide **dhcpcd** and, therefore, NetworkManager can not use this client.

### Procedure

1. Create the `/etc/NetworkManager/conf.d/dhcp-client.conf` file with the following content:

```
[main]
dhcp=dhclient
```

You can set the **dhcp** parameter to **internal** (default) or **dhclient**.

2. If you set the **dhcp** parameter to **dhclient**, install the **dhcp-client** package:

```
# yum install dhcp-client
```

3. Restart NetworkManager:

```
# systemctl restart NetworkManager
```

Note that the restart temporarily interrupts all network connections.

### Verification

- Search in the `/var/log/messages` log file for an entry similar to the following:

```
Apr 26 09:54:19 server NetworkManager[27748]: <info> [1650959659.8483] dhcp-init: Using
DHCP client 'dhclient'
```

This log entry confirms that NetworkManager uses **dhclient** as DHCP client.

### Additional resources

- **NetworkManager.conf(5)** man page

## 18.2. CONFIGURING THE DHCP BEHAVIOR OF A NETWORKMANAGER CONNECTION

A Dynamic Host Configuration Protocol (DHCP) client requests the dynamic IP address and corresponding configuration information from a DHCP server each time a client connects to the network.

When you configured a connection to retrieve an IP address from a DHCP server, the NetworkManager requests an IP address from a DHCP server. By default, the client waits 45 seconds for this request to be completed. When a **DHCP** connection is started, a dhcp client requests an IP address from a **DHCP** server.

## Prerequisites

- A connection that uses DHCP is configured on the host.

## Procedure

1. Set the **ipv4.dhcp-timeout** and **ipv6.dhcp-timeout** properties. For example, to set both options to **30** seconds, enter:

```
# nmcli connection modify connection_name ipv4.dhcp-timeout 30 ipv6.dhcp-timeout 30
```

Alternatively, set the parameters to **infinity** to configure that NetworkManager does not stop trying to request and renew an IP address until it is successful.

2. Optional: Configure the behavior if NetworkManager does not receive an IPv4 address before the timeout:

```
# nmcli connection modify connection_name ipv4.may-fail value
```

If you set the **ipv4.may-fail** option to:

- **yes**, the status of the connection depends on the IPv6 configuration:
    - If the IPv6 configuration is enabled and successful, NetworkManager activates the IPv6 connection and no longer tries to activate the IPv4 connection.
    - If the IPv6 configuration is disabled or not configured, the connection fails.
  - **no**, the connection is deactivated. In this case:
    - If the **autoconnect** property of the connection is enabled, NetworkManager retries to activate the connection as many times as set in the **autoconnect-retries** property. The default is **4**.
    - If the connection still cannot acquire a DHCP address, auto-activation fails. Note that after 5 minutes, the auto-connection process starts again to acquire an IP address from the DHCP server.
3. Optional: Configure the behavior if NetworkManager does not receive an IPv6 address before the timeout:

```
# nmcli connection modify connection_name ipv6.may-fail value
```

## Additional resources

- **nm-settings(5)** man page



## CHAPTER 19. RUNNING DHCLIENT EXIT HOOKS USING NETWORKMANAGER A DISPATCHER SCRIPT

You can use a NetworkManager dispatcher script to execute **dhclient** exit hooks.

### 19.1. THE CONCEPT OF NETWORKMANAGER DISPATCHER SCRIPTS

The **NetworkManager-dispatcher** service executes user-provided scripts in alphabetical order when network events happen. These scripts are typically shell scripts, but can be any executable script or application. You can use dispatcher scripts, for example, to adjust network-related settings that you cannot manage with NetworkManager.

You can store dispatcher scripts in the following directories:

- **/etc/NetworkManager/dispatcher.d/**: The general location for dispatcher scripts the **root** user can edit.
- **/usr/lib/NetworkManager/dispatcher.d/**: For pre-deployed immutable dispatcher scripts.

For security reasons, the **NetworkManager-dispatcher** service executes scripts only if the following conditions met:

- The script is owned by the **root** user.
- The script is only readable and writable by **root**.
- The **setuid** bit is not set on the script.

The **NetworkManager-dispatcher** service runs each script with two arguments:

1. The interface name of the device the operation happened on.
2. The action, such as **up**, when the interface has been activated.

The **Dispatcher scripts** section in the **NetworkManager(8)** man page provides an overview of actions and environment variables you can use in scripts.

The **NetworkManager-dispatcher** service runs one script at a time, but asynchronously from the main NetworkManager process. Note that, if a script is queued, the service will always run it, even if a later event makes it obsolete. However, the **NetworkManager-dispatcher** service runs scripts that are symbolic links referring to files in **/etc/NetworkManager/dispatcher.d/no-wait.d/** immediately, without waiting for the termination of previous scripts, and in parallel.

#### Additional resources

- **NetworkManager(8)** man page

### 19.2. CREATING A NETWORKMANAGER DISPATCHER SCRIPT THAT RUNS DHCLIENT EXIT HOOKS

When a DHCP server assigns or updates an IPv4 address, NetworkManager can run a dispatcher script stored in the **/etc/dhcp/dhclient-exit-hooks.d/** directory. This dispatcher script can then, for example, run **dhclient** exit hooks.

#### Prerequisites

## Prerequisites

- The **dhclient** exit hooks are stored in the `/etc/dhcp/dhclient-exit-hooks.d/` directory.

## Procedure

1. Create the `/etc/NetworkManager/dispatcher.d/12-dhclient-down` file with the following content:

```
#!/bin/bash
# Run dhclient.exit-hooks.d scripts

if [ -n "$DHCP4_DHCP_LEASE_TIME" ]; then
  if [ "$2" = "dhcp4-change" ] || [ "$2" = "up" ]; then
    if [ -d /etc/dhcp/dhclient-exit-hooks.d ]; then
      for f in /etc/dhcp/dhclient-exit-hooks.d/*.sh ; do
        if [ -x "$f" ]; then
          . "$f"
        fi
      done
    fi
  fi
fi
```

2. Set the **root** user as owner of the file:

```
# chown root:root /etc/NetworkManager/dispatcher.d/12-dhclient-down
```

3. Set the permissions so that only the root user can execute it:

```
# chmod 0700 /etc/NetworkManager/dispatcher.d/12-dhclient-down
```

4. Restore the SELinux context:

```
# restorecon /etc/NetworkManager/dispatcher.d/12-dhclient-down
```

## Additional resources

- **NetworkManager(8)** man page

## CHAPTER 20. MANUALLY CONFIGURING THE /ETC/RESOLV.CONF FILE

By default, NetworkManager dynamically updates the `/etc/resolv.conf` file with the DNS settings from active NetworkManager connection profiles. However, you can disable this behavior and manually configure DNS settings in `/etc/resolv.conf`.



### NOTE

Alternatively, if you require a specific order of DNS servers in `/etc/resolv.conf`, see [Configuring the order of DNS servers](#).

### 20.1. DISABLING DNS PROCESSING IN THE NETWORKMANAGER CONFIGURATION

By default, NetworkManager manages DNS settings in the `/etc/resolv.conf` file, and you can configure the order of DNS servers. Alternatively, you can disable DNS processing in NetworkManager if you prefer to manually configure DNS settings in `/etc/resolv.conf`.

#### Procedure

1. As the root user, create the `/etc/NetworkManager/conf.d/90-dns-none.conf` file with the following content by using a text editor:

```
[main]
dns=none
```

2. Reload the **NetworkManager** service:

```
# systemctl reload NetworkManager
```



### NOTE

After you reload the service, NetworkManager no longer updates the `/etc/resolv.conf` file. However, the last contents of the file are preserved.

3. Optionally, remove the **Generated by NetworkManager** comment from `/etc/resolv.conf` to avoid confusion.

#### Verification

1. Edit the `/etc/resolv.conf` file and manually update the configuration.
2. Reload the **NetworkManager** service:

```
# systemctl reload NetworkManager
```

3. Display the `/etc/resolv.conf` file:

```
# cat /etc/resolv.conf
```

If you successfully disabled DNS processing, NetworkManager did not override the manually configured settings.

## Troubleshooting

- Display the NetworkManager configuration to ensure that no other configuration file with a higher priority overrode the setting:

```
# NetworkManager --print-config
...
dns=none
...
```

## Additional resources

- **NetworkManager.conf(5)** man page
- [Configuring the order of DNS servers using NetworkManager](#)

## 20.2. REPLACING /ETC/RESOLV.CONF WITH A SYMBOLIC LINK TO MANUALLY CONFIGURE DNS SETTINGS

By default, NetworkManager manages DNS settings in the `/etc/resolv.conf` file, and you can configure the order of DNS servers. Alternatively, you can disable DNS processing in NetworkManager if you prefer to manually configure DNS settings in `/etc/resolv.conf`. For example, NetworkManager does not automatically update the DNS configuration if `/etc/resolv.conf` is a symbolic link.

### Prerequisites

- The NetworkManager `rc-manager` configuration option is not set to `file`. To verify, use the `NetworkManager --print-config` command.

### Procedure

1. Create a file, such as `/etc/resolv.conf.manually-configured`, and add the DNS configuration for your environment to it. Use the same parameters and syntax as in the original `/etc/resolv.conf`.
2. Remove the `/etc/resolv.conf` file:

```
# rm /etc/resolv.conf
```

3. Create a symbolic link named `/etc/resolv.conf` that refers to `/etc/resolv.conf.manually-configured`:

```
# ln -s /etc/resolv.conf.manually-configured /etc/resolv.conf
```

### Additional resources

- **resolv.conf(5)** man page
- **NetworkManager.conf(5)** man page
- [Configuring the order of DNS servers using NetworkManager](#)

## CHAPTER 21. CONFIGURING THE ORDER OF DNS SERVERS

Most applications use the `getaddrinfo()` function of the `glibc` library to resolve DNS requests. By default, `glibc` sends all DNS requests to the first DNS server specified in the `/etc/resolv.conf` file. If this server does not reply, RHEL uses the next server in this file. NetworkManager enables you to influence the order of DNS servers in `etc/resolv.conf`.

### 21.1. HOW NETWORKMANAGER ORDERS DNS SERVERS IN /ETC/RESOLV.CONF

NetworkManager orders DNS servers in the `/etc/resolv.conf` file based on the following rules:

- If only one connection profile exists, NetworkManager uses the order of IPv4 and IPv6 DNS server specified in that connection.
- If multiple connection profiles are activated, NetworkManager orders DNS servers based on a DNS priority value. If you set DNS priorities, the behavior of NetworkManager depends on the value set in the `dns` parameter. You can set this parameter in the `[main]` section in the `/etc/NetworkManager/NetworkManager.conf` file:

- **dns=default** or if the `dns` parameter is not set:  
NetworkManager orders the DNS servers from different connections based on the `ipv4.dns-priority` and `ipv6.dns-priority` parameter in each connection.

If you set no value or you set `ipv4.dns-priority` and `ipv6.dns-priority` to `0`, NetworkManager uses the global default value. See [Default values of DNS priority parameters](#).

- **dns=dnsmasq** or **dns=systemd-resolved**:  
When you use one of these settings, NetworkManager sets either `127.0.0.1` for `dnsmasq` or `127.0.0.53` as `nameserver` entry in the `/etc/resolv.conf` file.

Both the `dnsmasq` and `systemd-resolved` services forward queries for the search domain set in a NetworkManager connection to the DNS server specified in that connection, and forwards queries to other domains to the connection with the default route. When multiple connections have the same search domain set, `dnsmasq` and `systemd-resolved` forward queries for this domain to the DNS server set in the connection with the lowest priority value.

#### Default values of DNS priority parameters

NetworkManager uses the following default values for connections:

- **50** for VPN connections
- **100** for other connections

#### Valid DNS priority values:

You can set both the global default and connection-specific `ipv4.dns-priority` and `ipv6.dns-priority` parameters to a value between `-2147483647` and `2147483647`.

- A lower value has a higher priority.
- Negative values have the special effect of excluding other configurations with a greater value. For example, if at least one connection with a negative priority value exists, NetworkManager uses only the DNS servers specified in the connection profile with the lowest priority.

- If multiple connections have the same DNS priority, NetworkManager prioritizes the DNS in the following order:
  - a. VPN connections
  - b. Connection with an active default route. The active default route is the default route with the lowest metric.

### Additional resources

- **nm-settings(5)** man page
- [Using different DNS servers for different domains](#)

## 21.2. SETTING A NETWORKMANAGER-WIDE DEFAULT DNS SERVER PRIORITY VALUE

NetworkManager uses the following DNS priority default values for connections:

- **50** for VPN connections
- **100** for other connections

You can override these system-wide defaults with a custom default value for IPv4 and IPv6 connections.

### Procedure

1. Edit the **/etc/NetworkManager/NetworkManager.conf** file:
  - a. Add the **[connection]** section, if it does not exist:

```
[connection]
```

- b. Add the custom default values to the **[connection]** section. For example, to set the new default for both IPv4 and IPv6 to **200**, add:

```
ipv4.dns-priority=200
ipv6.dns-priority=200
```

You can set the parameters to a value between **-2147483647** and **2147483647**. Note that setting the parameters to **0** enables the built-in defaults ( **50** for VPN connections and **100** for other connections).

2. Reload the **NetworkManager** service:

```
# systemctl reload NetworkManager
```

### Additional resources

- **NetworkManager.conf(5)** man page

## 21.3. SETTING THE DNS PRIORITY OF A NETWORKMANAGER CONNECTION

If you require a specific order of DNS servers you can set priority values in connection profiles. NetworkManager uses these values to order the servers when the service creates or updates the `/etc/resolv.conf` file.

Note that setting DNS priorities makes only sense if you have multiple connections with different DNS servers configured. If you have only one connection with multiple DNS servers configured, manually set the DNS servers in the preferred order in the connection profile.

### Prerequisites

- The system has multiple NetworkManager connections configured.
- The system either has no `dns` parameter set in the `/etc/NetworkManager/NetworkManager.conf` file or the parameter is set to `default`.

### Procedure

1. Optionally, display the available connections:

```
# nmcli connection show
NAME          UUID                                TYPE  DEVICE
Example_con_1 d17ee488-4665-4de2-b28a-48befab0cd43 ethernet enp1s0
Example_con_2 916e4f67-7145-3ffa-9f7b-e7cada8f6bf7 ethernet enp7s0
...
```

2. Set the `ipv4.dns-priority` and `ipv6.dns-priority` parameters. For example, to set both parameters to `10` for the `Example_con_1` connection:

```
# nmcli connection modify Example_con_1 ipv4.dns-priority 10 ipv6.dns-priority 10
```

3. Optionally, repeat the previous step for other connections.
4. Re-activate the connection you updated:

```
# nmcli connection up Example_con_1
```

### Verification

- Display the contents of the `/etc/resolv.conf` file to verify that the DNS server order is correct:

```
# cat /etc/resolv.conf
```

## CHAPTER 22. USING DIFFERENT DNS SERVERS FOR DIFFERENT DOMAINS

By default, Red Hat Enterprise Linux (RHEL) sends all DNS requests to the first DNS server specified in the `/etc/resolv.conf` file. If this server does not reply, RHEL uses the next server in this file. In environments where one DNS server cannot resolve all domains, administrators can configure RHEL to send DNS requests for a specific domain to a selected DNS server.

For example, you connect a server to a Virtual Private Network (VPN), and hosts in the VPN use the `example.com` domain. In this case, you can configure RHEL to process DNS queries in the following way:

- Send only DNS requests for `example.com` to the DNS server in the VPN network.
- Send all other requests to the DNS server that is configured in the connection profile with the default gateway.

### 22.1. USING DNSMASQ IN NETWORKMANAGER TO SEND DNS REQUESTS FOR A SPECIFIC DOMAIN TO A SELECTED DNS SERVER

You can configure NetworkManager to start an instance of `dnsmasq`. This DNS caching server then listens on port `53` on the `loopback` device. Consequently, this service is only reachable from the local system and not from the network.

With this configuration, NetworkManager adds the `nameserver 127.0.0.1` entry to the `/etc/resolv.conf` file, and `dnsmasq` dynamically routes DNS requests to the corresponding DNS servers specified in the NetworkManager connection profiles.

#### Prerequisites

- The system has multiple NetworkManager connections configured.
- A DNS server and search domain are configured in the NetworkManager connection profile that is responsible for resolving a specific domain.  
For example, to ensure that the DNS server specified in a VPN connection resolves queries for the `example.com` domain, the VPN connection profile must contain the following settings:
  - A DNS server that can resolve `example.com`
  - A search domain set to `example.com` in the `ipv4.dns-search` and `ipv6.dns-search` parameters
- The `dnsmasq` service is not running or configured to listen on a different interface than `localhost`.

#### Procedure

1. Install the `dnsmasq` package:

```
# yum install dnsmasq
```

2. Edit the `/etc/NetworkManager/NetworkManager.conf` file, and set the following entry in the `[main]` section:



```
dns=dnsmasq
```

3. Reload the **NetworkManager** service:

```
# systemctl reload NetworkManager
```

## Verification

1. Search in the **systemd** journal of the **NetworkManager** unit for which domains the service uses a different DNS server:

```
# journalctl -xeu NetworkManager
...
Jun 02 13:30:17 client_hostname dnsmasq[5298]: using nameserver 198.51.100.7#53 for
domain example.com
...
```

2. Use the **tcpdump** packet sniffer to verify the correct route of DNS requests:

- a. Install the **tcpdump** package:

```
# yum install tcpdump
```

- b. On one terminal, start **tcpdump** to capture DNS traffic on all interfaces:

```
# tcpdump -i any port 53
```

- c. On a different terminal, resolve host names for a domain for which an exception exists and another domain, for example:

```
# host -t A www.example.com
# host -t A www.redhat.com
```

- d. Verify in the **tcpdump** output that Red Hat Enterprise Linux sends only DNS queries for the **example.com** domain to the designated DNS server and through the corresponding interface:

```
...
13:52:42.234533 IP server.43534 > 198.51.100.7.domain: 50121+ [1au] A?
www.example.com. (33)
...
13:52:57.753235 IP server.40864 > 192.0.2.1.domain: 6906+ A? www.redhat.com. (33)
...
```

Red Hat Enterprise Linux sends the DNS query for **www.example.com** to the DNS server on **198.51.100.7** and the query for **www.redhat.com** to **192.0.2.1**.

## Troubleshooting

1. Verify that the **nameserver** entry in the **/etc/resolv.conf** file refers to **127.0.0.1**:

```
# cat /etc/resolv.conf
nameserver 127.0.0.1
```

-

If the entry is missing, check the **dns** parameter in the **/etc/NetworkManager/NetworkManager.conf** file.

2. Verify that the **dnsmasq** service listens on port **53** on the **loopback** device:

```
# ss -tulpn | grep "127.0.0.1:53"
udp UNCONN 0 0 127.0.0.1:53 0.0.0.0:* users:(("dnsmasq",pid=7340,fd=18))
tcp LISTEN 0 32 127.0.0.1:53 0.0.0.0:* users:(("dnsmasq",pid=7340,fd=19))
```

If the service does not listen on **127.0.0.1:53**, check the journal entries of the **NetworkManager** unit:

```
# journalctl -u NetworkManager
```

## 22.2. USING SYSTEMD-RESOLVED IN NETWORKMANAGER TO SEND DNS REQUESTS FOR A SPECIFIC DOMAIN TO A SELECTED DNS SERVER

You can configure NetworkManager to start an instance of **systemd-resolved**. This DNS stub resolver then listens on port **53** on IP address **127.0.0.53**. Consequently, this stub resolver is only reachable from the local system and not from the network.

With this configuration, NetworkManager adds the **nameserver 127.0.0.53** entry to the **/etc/resolv.conf** file, and **systemd-resolved** dynamically routes DNS requests to the corresponding DNS servers specified in the NetworkManager connection profiles.

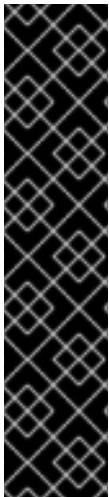

### IMPORTANT

The **systemd-resolved** service is provided as a Technology Preview only. Technology Preview features are not supported with Red Hat production Service Level Agreements (SLAs), might not be functionally complete, and Red Hat does not recommend using them for production. These previews provide early access to upcoming product features, enabling customers to test functionality and provide feedback during the development process.

See [Technology Preview Features Support Scope](#) on the Red Hat Customer Portal for information about the support scope for Technology Preview features.

For a supported solution, see [Using dnsmasq in NetworkManager to send DNS requests for a specific domain to a selected DNS server](#).

### Prerequisites

- The system has multiple NetworkManager connections configured.
- A DNS server and search domain are configured in the NetworkManager connection profile that is responsible for resolving a specific domain.  
For example, to ensure that the DNS server specified in a VPN connection resolves queries for the **example.com** domain, the VPN connection profile must contain the following settings:
  - A DNS server that can resolve **example.com**

- A search domain set to **example.com** in the **ipv4.dns-search** and **ipv6.dns-search** parameters

## Procedure

1. Enable and start the **systemd-resolved** service:

```
# systemctl --now enable systemd-resolved
```

2. Edit the **/etc/NetworkManager/NetworkManager.conf** file, and set the following entry in the **[main]** section:

```
dns=systemd-resolved
```

3. Reload the **NetworkManager** service:

```
# systemctl reload NetworkManager
```

## Verification

1. Display the DNS servers **systemd-resolved** uses and for which domains the service uses a different DNS server:

```
# resolvectl
...
Link 2 (enp1s0)
  Current Scopes: DNS
  Protocols: +DefaultRoute ...
  Current DNS Server: 192.0.2.1
  DNS Servers: 192.0.2.1

Link 3 (tun0)
  Current Scopes: DNS
  Protocols: -DefaultRoute ...
  Current DNS Server: 198.51.100.7
  DNS Servers: 198.51.100.7 203.0.113.19
  DNS Domain: example.com
```

The output confirms that **systemd-resolved** uses different DNS servers for the **example.com** domain.

2. Use the **tcpdump** packet sniffer to verify the correct route of DNS requests:

- a. Install the **tcpdump** package:

```
# yum install tcpdump
```

- b. On one terminal, start **tcpdump** to capture DNS traffic on all interfaces:

```
# tcpdump -i any port 53
```

- c. On a different terminal, resolve host names for a domain for which an exception exists and another domain, for example:

```
# host -t A www.example.com
# host -t A www.redhat.com
```

- d. Verify in the **tcpdump** output that Red Hat Enterprise Linux sends only DNS queries for the **example.com** domain to the designated DNS server and through the corresponding interface:

```
...
13:52:42.234533 IP server.43534 > 198.51.100.7.domain: 50121+ [1au] A?
www.example.com. (33)
...
13:52:57.753235 IP server.40864 > 192.0.2.1.domain: 6906+ A? www.redhat.com. (33)
...
```

Red Hat Enterprise Linux sends the DNS query for **www.example.com** to the DNS server on **198.51.100.7** and the query for **www.redhat.com** to **192.0.2.1**.

## Troubleshooting

1. Verify that the **nameserver** entry in the **/etc/resolv.conf** file refers to **127.0.0.53**:

```
# cat /etc/resolv.conf
nameserver 127.0.0.53
```

If the entry is missing, check the **dns** parameter in the **/etc/NetworkManager/NetworkManager.conf** file.

2. Verify that the **systemd-resolved** service listens on port **53** on the local IP address **127.0.0.53**:

```
# ss -tulpn | grep "127.0.0.53"
udp UNCONN 0 0 127.0.0.53%lo:53 0.0.0.0:* users:(("systemd-
resolve",pid=1050,fd=12))
tcp LISTEN 0 4096 127.0.0.53%lo:53 0.0.0.0:* users:(("systemd-
resolve",pid=1050,fd=13))
```

If the service does not listen on **127.0.0.53:53**, check if the **systemd-resolved** service is running.

## CHAPTER 23. MANAGING THE DEFAULT GATEWAY SETTING

The default gateway is a router that forwards network packets when no other route matches the destination of a packet. In a local network, the default gateway is typically the host that is one hop closer to the internet.

### 23.1. SETTING THE DEFAULT GATEWAY ON AN EXISTING CONNECTION BY USING NMCLI

In most situations, administrators set the default gateway when they create a connection as explained in, for example, [Configuring an Ethernet connection by using nmcli](#).

In most situations, administrators set the default gateway when they create a connection. However, you can also set or update the default gateway setting on a previously created connection using the **nmcli** utility.

#### Prerequisites

- At least one static IP address must be configured on the connection on which the default gateway will be set.
- If the user is logged in on a physical console, user permissions are sufficient. Otherwise, user must have **root** permissions.

#### Procedure

1. Set the IP address of the default gateway.

For example, to set the IPv4 address of the default gateway on the **example** connection to **192.0.2.1**:

```
# nmcli connection modify example ipv4.gateway "192.0.2.1"
```

For example, to set the IPv6 address of the default gateway on the **example** connection to **2001:db8:1::1**:

```
# nmcli connection modify example ipv6.gateway "2001:db8:1::1"
```

2. Restart the network connection for changes to take effect. For example, to restart the **example** connection using the command line:

```
# nmcli connection up example
```



#### WARNING

All connections currently using this network connection are temporarily interrupted during the restart.

3. Optionally, verify that the route is active.

To display the IPv4 default gateway:

```
# ip -4 route
default via 192.0.2.1 dev example proto static metric 100
```

To display the IPv6 default gateway:

```
# ip -6 route
default via 2001:db8:1::1 dev example proto static metric 100 pref medium
```

## 23.2. SETTING THE DEFAULT GATEWAY ON AN EXISTING CONNECTION BY USING THE NMCLI INTERACTIVE MODE

In most situations, administrators set the default gateway when they create a connection as explained in, for example, [Configuring an Ethernet connection by using the nmcli interactive editor](#)

In most situations, administrators set the default gateway when they create a connection. However, you can also set or update the default gateway setting on a previously created connection using the interactive mode of the **nmcli** utility.

### Prerequisites

- At least one static IP address must be configured on the connection on which the default gateway will be set.
- If the user is logged in on a physical console, user permissions are sufficient. Otherwise, the user must have **root** permissions.

### Procedure

1. Open the **nmcli** interactive mode for the required connection. For example, to open the **nmcli** interactive mode for the *example* connection:

```
# nmcli connection edit example
```

2. Set the default gateway.  
For example, to set the IPv4 address of the default gateway on the *example* connection to **192.0.2.1**:

```
nmcli> set ipv4.gateway 192.0.2.1
```

For example, to set the IPv6 address of the default gateway on the *example* connection to **2001:db8:1::1**:

```
nmcli> set ipv6.gateway 2001:db8:1::1
```

3. Optionally, verify that the default gateway was set correctly:

```
nmcli> print
...
ipv4.gateway:                192.0.2.1
```

```
...
ipv6.gateway:          2001:db8:1::1
...
```

4. Save the configuration:

```
nmcli> save persistent
```

5. Restart the network connection for changes to take effect:

```
nmcli> activate example
```



#### WARNING

All connections currently using this network connection are temporarily interrupted during the restart.

6. Leave the **nmcli** interactive mode:

```
nmcli> quit
```

7. Optionally, verify that the route is active.

To display the IPv4 default gateway:

```
# ip -4 route
default via 192.0.2.1 dev example proto static metric 100
```

To display the IPv6 default gateway:

```
# ip -6 route
default via 2001:db8:1::1 dev example proto static metric 100 pref medium
```

#### Additional resources

- [Configuring an Ethernet connection by using the nmcli interactive editor](#)

### 23.3. SETTING THE DEFAULT GATEWAY ON AN EXISTING CONNECTION BY USING NM-CONNECTION-EDITOR

In most situations, administrators set the default gateway when they create a connection. However, you can also set or update the default gateway setting on a previously created connection using the **nm-connection-editor** application.

#### Prerequisites

- At least one static IP address must be configured on the connection on which the default gateway will be set.

## Procedure

1. Open a terminal, and enter **nm-connection-editor**:

```
# nm-connection-editor
```

2. Select the connection to modify, and click the gear wheel icon to edit the existing connection.
3. Set the IPv4 default gateway. For example, to set the IPv4 address of the default gateway on the connection to **192.0.2.1**:
  - a. Open the **IPv4 Settings** tab.
  - b. Enter the address in the **gateway** field next to the IP range the gateway's address is within:

Addresses		
Address	Netmask	Gateway
192.0.2.123	24	192.0.2.1

4. Set the IPv6 default gateway. For example, to set the IPv6 address of the default gateway on the connection to **2001:db8:1::1**:
  - a. Open the **IPv6** tab.
  - b. Enter the address in the **gateway** field next to the IP range the gateway's address is within:

Addresses		
Address	Prefix	Gateway
2001:db8:1::5	64	2001:db8:1::1

5. Click **OK**.
6. Click **Save**.
7. Restart the network connection for changes to take effect. For example, to restart the **example** connection using the command line:

```
# nmcli connection up example
```



### WARNING

All connections currently using this network connection are temporarily interrupted during the restart.

8. Optionally, verify that the route is active.  
To display the IPv4 default gateway:



**# ip -4 route**

```
default via 192.0.2.1 dev example proto static metric 100
```

To display the IPv6 default gateway:

**# ip -6 route**

```
default via 2001:db8:1::1 dev example proto static metric 100 pref medium
```

**Additional resources**

- [Configuring an Ethernet connection by using nm-connection-editor](#)

## 23.4. SETTING THE DEFAULT GATEWAY ON AN EXISTING CONNECTION BY USING CONTROL-CENTER

In most situations, administrators set the default gateway when they create a connection. However, you can also set or update the default gateway setting on a previously created connection using the **control-center** application.

**Prerequisites**

- At least one static IP address must be configured on the connection on which the default gateway will be set.
- The network configuration of the connection is open in the **control-center** application.

**Procedure**

1. Set the IPv4 default gateway. For example, to set the IPv4 address of the default gateway on the connection to **192.0.2.1**:
  - a. Open the **IPv4** tab.
  - b. Enter the address in the **gateway** field next to the IP range the gateway's address is within:

Addresses		
Address	Netmask	Gateway
192.0.2.123	255.255.255.0	192.0.2.1

2. Set the IPv6 default gateway. For example, to set the IPv6 address of the default gateway on the connection to **2001:db8:1::1**:
  - a. Open the **IPv6** tab.
  - b. Enter the address in the **gateway** field next to the IP range the gateway's address is within:

Addresses		
Address	Prefix	Gateway
2001:db8:1::5	64	2001:db8:1::1

3. Click **Apply**.

- Back in the **Network** window, disable and re-enable the connection by switching the button for the connection to **Off** and back to **On** for changes to take effect.

**WARNING**

All connections currently using this network connection are temporarily interrupted during the restart.

- Optionally, verify that the route is active.  
To display the IPv4 default gateway:

```
$ ip -4 route
default via 192.0.2.1 dev example proto static metric 100
```

To display the IPv6 default gateway:

```
$ ip -6 route
default via 2001:db8:1::1 dev example proto static metric 100 pref medium
```

**Additional resources**

- [Configuring an Ethernet connection by using control-center](#)

## 23.5. SETTING THE DEFAULT GATEWAY ON AN EXISTING CONNECTION BY USING NMSTATECTL

Use the **nmstatectl** utility to set the default gateway through the Nmstate API. The Nmstate API ensures that, after setting the configuration, the result matches the configuration file. If anything fails, **nmstatectl** automatically rolls back the changes to avoid leaving the system in an incorrect state.

**Prerequisites**

- At least one static IP address must be configured on the connection on which the default gateway will be set.
- The **enp1s0** interface is configured, and the IP address of the default gateway is within the subnet of the IP configuration of this interface.
- The **nmstate** package is installed.

**Procedure**

- Create a YAML file, for example **~/set-default-gateway.yml**, with the following content:

```
---
routes:
  config:
```

```
- destination: 0.0.0.0
  next-hop-address: 192.0.2.1
  next-hop-interface: enp1s0
```

These settings define **192.0.2.1** as the default gateway, and the default gateway is reachable through the **enp1s0** interface.

2. Apply the settings to the system:

```
# nmstatectl apply ~/set-default-gateway.yml
```

#### Additional resources

- **nmstatectl(8)** man page
- `/usr/share/doc/nmstate/examples/` directory

## 23.6. SETTING THE DEFAULT GATEWAY ON AN EXISTING CONNECTION BY USING THE NETWORK RHEL SYSTEM ROLE

You can use the **network** RHEL system role to set the default gateway.



### IMPORTANT

When you run a play that uses the **network** RHEL system role and if the setting values do not match the values specified in the play, the role overrides the existing connection profile with the same name. To prevent resetting these values to their defaults, always specify the whole configuration of the network connection profile in the play, even if the configuration, for example the IP configuration, already exists.

Depending on whether it already exists, the procedure creates or updates the **enp1s0** connection profile with the following settings:

- A static IPv4 address - **198.51.100.20** with a **/24** subnet mask
- A static IPv6 address - **2001:db8:1::1** with a **/64** subnet mask
- An IPv4 default gateway - **198.51.100.254**
- An IPv6 default gateway - **2001:db8:1::fffe**
- An IPv4 DNS server - **198.51.100.200**
- An IPv6 DNS server - **2001:db8:1::ffbb**
- A DNS search domain - **example.com**

#### Prerequisites

- [You have prepared the control node and the managed nodes](#)
- You are logged in to the control node as a user who can run playbooks on the managed nodes.
- The account you use to connect to the managed nodes has **sudo** permissions on them.

## Procedure

1. Create a playbook file, for example `~/playbook.yml`, with the following content:

```
---
- name: Configure the network
  hosts: managed-node-01.example.com
  tasks:
    - name: Configure an Ethernet connection with static IP and default gateway
      ansible.builtin.include_role:
        name: rhel-system-roles.network
      vars:
        network_connections:
          - name: enp1s0
            type: ethernet
            autoconnect: yes
            ip:
              address:
                - 198.51.100.20/24
                - 2001:db8:1::1/64
              gateway4: 198.51.100.254
              gateway6: 2001:db8:1::fffe
            dns:
              - 198.51.100.200
              - 2001:db8:1::ffbb
            dns_search:
              - example.com
            state: up
```

2. Validate the playbook syntax:

```
$ ansible-playbook --syntax-check ~/playbook.yml
```

Note that this command only validates the syntax and does not protect against a wrong but valid configuration.

3. Run the playbook:

```
$ ansible-playbook ~/playbook.yml
```

## Additional resources

- `/usr/share/ansible/roles/rhel-system-roles.network/README.md` file
- `/usr/share/doc/rhel-system-roles/network/` directory

## 23.7. SETTING THE DEFAULT GATEWAY ON AN EXISTING CONNECTION WHEN USING THE LEGACY NETWORK SCRIPTS

In most situations, administrators set the default gateway when they create a connection. However, you can also set or update the default gateway setting on a previously created connection when you use the legacy network scripts.

## Prerequisites

- The **NetworkManager** package is not installed, or the **NetworkManager** service is disabled.
- The **network-scripts** package is installed.

### Procedure

1. Set the **GATEWAY** parameter in the `/etc/sysconfig/network-scripts/ifcfg-enp1s0` file to **192.0.2.1**:

```
GATEWAY=192.0.2.1
```

2. Add the **default** entry in the `/etc/sysconfig/network-scripts/route-enp0s1` file:

```
default via 192.0.2.1
```

3. Restart the network:

```
# systemctl restart network
```

## 23.8. HOW NETWORKMANAGER MANAGES MULTIPLE DEFAULT GATEWAYS

In certain situations, for example for fallback reasons, you set multiple default gateways on a host. However, to avoid asynchronous routing issues, each default gateway of the same protocol requires a separate metric value. Note that RHEL only uses the connection to the default gateway that has the lowest metric set.

You can set the metric for both the IPv4 and IPv6 gateway of a connection using the following command:

```
# nmcli connection modify connection-name ipv4.route-metric value ipv6.route-metric value
```



### IMPORTANT

Do not set the same metric value for the same protocol in multiple connection profiles to avoid routing issues.

If you set a default gateway without a metric value, NetworkManager automatically sets the metric value based on the interface type. For that, NetworkManager assigns the default value of this network type to the first connection that is activated, and sets an incremented value to each other connection of the same type in the order they are activated. For example, if two Ethernet connections with a default gateway exist, NetworkManager sets a metric of **100** on the route to the default gateway of the connection that you activate first. For the second connection, NetworkManager sets **101**.

The following is an overview of frequently-used network types and their default metrics:

Connection type	Default metric value
VPN	50

Connection type	Default metric value
Ethernet	100
MACsec	125
InfiniBand	150
Bond	300
Team	350
VLAN	400
Bridge	425
TUN	450
Wi-Fi	600
IP tunnel	675

### Additional resources

- [Configuring policy-based routing to define alternative routes](#)
- [Getting started with Multipath TCP](#)

## 23.9. CONFIGURING NETWORKMANAGER TO AVOID USING A SPECIFIC PROFILE TO PROVIDE A DEFAULT GATEWAY

You can configure that NetworkManager never uses a specific profile to provide the default gateway. Follow this procedure for connection profiles that are not connected to the default gateway.

### Prerequisites

- The NetworkManager connection profile for the connection that is not connected to the default gateway exists.

### Procedure

1. If the connection uses a dynamic IP configuration, configure that NetworkManager does not use the connection as the default route for IPv4 and IPv6 connections:

```
# nmcli connection modify connection_name ipv4.never-default yes ipv6.never-default yes
```

Note that setting **ipv4.never-default** and **ipv6.never-default** to **yes**, automatically removes the default gateway's IP address for the corresponding protocol from the connection profile.

2. Activate the connection:

```
# nmcli connection up connection_name
```

### Verification

- Use the **ip -4 route** and **ip -6 route** commands to verify that RHEL does not use the network interface for the default route for the IPv4 and IPv6 protocol.

## 23.10. FIXING UNEXPECTED ROUTING BEHAVIOR DUE TO MULTIPLE DEFAULT GATEWAYS

There are only a few scenarios, such as when using multipath TCP, in which you require multiple default gateways on a host. In most cases, you configure only a single default gateway to avoid unexpected routing behavior or asynchronous routing issues.



### NOTE

To route traffic to different internet providers, use policy-based routing instead of multiple default gateways.

### Prerequisites

- The host uses NetworkManager to manage network connections, which is the default.
- The host has multiple network interfaces.
- The host has multiple default gateways configured.

### Procedure

1. Display the routing table:

- For IPv4, enter:

```
# ip -4 route
default via 192.0.2.1 dev enp1s0 proto static metric 101
default via 198.51.100.1 dev enp7s0 proto static metric 102
...
```

- For IPv6, enter:

```
# ip -6 route
default via 2001:db8:1::1 dev enp1s0 proto static metric 101 pref medium
default via 2001:db8:2::1 dev enp7s0 proto static metric 102 pref medium
...
```

Entries starting with **default** indicate a default route. Note the interface names of these entries displayed next to **dev**.

2. Use the following commands to display the NetworkManager connections that use the interfaces you identified in the previous step:

```
# nmcli -f GENERAL.CONNECTION,IP4.GATEWAY,IP6.GATEWAY device show enp1s0
GENERAL.CONNECTION: Corporate-LAN
IP4.GATEWAY: 192.0.2.1
IP6.GATEWAY: 2001:db8:1::1

# nmcli -f GENERAL.CONNECTION,IP4.GATEWAY,IP6.GATEWAY device show enp7s0
GENERAL.CONNECTION: Internet-Provider
IP4.GATEWAY: 198.51.100.1
IP6.GATEWAY: 2001:db8:2::1
```

In these examples, the profiles named **Corporate-LAN** and **Internet-Provider** have the default gateways set. Because, in a local network, the default gateway is typically the host that is one hop closer to the internet, the rest of this procedure assumes that the default gateways in the **Corporate-LAN** are incorrect.

3. Configure that NetworkManager does not use the **Corporate-LAN** connection as the default route for IPv4 and IPv6 connections:

```
# nmcli connection modify Corporate-LAN ipv4.never-default yes ipv6.never-default yes
```

Note that setting **ipv4.never-default** and **ipv6.never-default** to **yes**, automatically removes the default gateway's IP address for the corresponding protocol from the connection profile.

4. Activate the **Corporate-LAN** connection:

```
# nmcli connection up Corporate-LAN
```

## Verification

- Display the IPv4 and IPv6 routing tables and verify that only one default gateway is available for each protocol:
  - For IPv4, enter:

```
# ip -4 route
default via 192.0.2.1 dev enp1s0 proto static metric 101
...
```

- For IPv6, enter:

```
# ip -6 route
default via 2001:db8:1::1 dev enp1s0 proto static metric 101 pref medium
...
```

## Additional resources

- [Configuring policy-based routing to define alternative routes](#)
- [Getting started with Multipath TCP](#)



## CHAPTER 24. CONFIGURING STATIC ROUTES

Routing ensures that you can send and receive traffic between mutually-connected networks. In larger environments, administrators typically configure services so that routers can dynamically learn about other routers. In smaller environments, administrators often configure static routes to ensure that traffic can reach from one network to the next.

You need static routes to achieve a functioning communication among multiple networks if all of these conditions apply:

- The traffic has to pass multiple networks.
- The exclusive traffic flow through the default gateways is not sufficient.

Section 24.1, “Example of a network that requires static routes” describes scenarios and how the traffic flows between different networks when you do not configure static routes.

### 24.1. EXAMPLE OF A NETWORK THAT REQUIRES STATIC ROUTES

You require static routes in this example because not all IP networks are directly connected through one router. Without the static routes, some networks cannot communicate with each other. Additionally, traffic from some networks flows only in one direction.



#### NOTE

The network topology in this example is artificial and only used to explain the concept of static routing. It is not a recommended topology in production environments.

For a functioning communication among all networks in this example, configure a static route to Raleigh (**198.51.100.0/24**) with next the hop Router 2 ( **203.0.113.10**). The IP address of the next hop is the one of Router 2 in the data center network ( **203.0.113.0/24**).

You can configure the static route as follows:

- For a simplified configuration, set this static route only on Router 1. However, this increases the traffic on Router 1 because hosts from the data center ( **203.0.113.0/24**) send traffic to Raleigh ( **198.51.100.0/24**) always through Router 1 to Router 2.
- For a more complex configuration, configure this static route on all hosts in the data center ( **203.0.113.0/24**). All hosts in this subnet then send traffic directly to Router 2 ( **203.0.113.10**) that is closer to Raleigh ( **198.51.100.0/24**).

For more details between which networks traffic flows or not, see the explanations below the diagram.



270\_RHEL\_0822

In case that the required static routes are not configured the following are the situations in which the communication works and when it does not:

- Hosts in the Berlin network (**192.0.2.0/24**):
  - Can communicate with other hosts in the same subnet because they are directly connected.
  - Can communicate with the internet because Router 1 is in the Berlin network (**192.0.2.0/24**) and has a default gateway, which leads to the internet.
  - Can communicate with the data center network (**203.0.113.0/24**) because Router 1 has interfaces in both the Berlin (**192.0.2.0/24**) and the data center (**203.0.113.0/24**) networks.
  - Cannot communicate with the Raleigh network (**198.51.100.0/24**) because Router 1 has no interface in this network. Therefore, Router 1 sends the traffic to its own default gateway (internet).
- Hosts in the data center network (**203.0.113.0/24**):
  - Can communicate with other hosts in the same subnet because they are directly connected.
  - Can communicate with the internet because they have their default gateway set to Router 1, and Router 1 has interfaces in both networks, the data center (**203.0.113.0/24**) and to the internet.

- Can communicate with the Berlin network (**192.0.2.0/24**) because they have their default gateway set to Router 1, and Router 1 has interfaces in both the data center (**203.0.113.0/24**) and the Berlin (**192.0.2.0/24**) networks.
- Cannot communicate with the Raleigh network (**198.51.100.0/24**) because the data center network has no interface in this network. Therefore, hosts in the data center (**203.0.113.0/24**) send traffic to their default gateway (Router 1). Router 1 also has no interface in the Raleigh network (**198.51.100.0/24**) and, as a result, Router 1 sends this traffic to its own default gateway (internet).
- Hosts in the Raleigh network (**198.51.100.0/24**):
  - Can communicate with other hosts in the same subnet because they are directly connected.
  - Cannot communicate with hosts on the internet. Router 2 sends the traffic to Router 1 because of the default gateway settings. The actual behavior of Router 1 depends on the reverse path filter (**rp\_filter**) system control (**sysctl**) setting. By default on RHEL, Router 1 drops the outgoing traffic instead of routing it to the internet. However, regardless of the configured behavior, communication is not possible without the static route.
  - Cannot communicate with the data center network (**203.0.113.0/24**). The outgoing traffic reaches the destination through Router 2 because of the default gateway setting. However, replies to packets do not reach the sender because hosts in the data center network (**203.0.113.0/24**) send replies to their default gateway (Router 1). Router 1 then sends the traffic to the internet.
  - Cannot communicate with the Berlin network (**192.0.2.0/24**). Router 2 sends the traffic to Router 1 because of the default gateway settings. The actual behavior of Router 1 depends on the **rp\_filter sysctl** setting. By default on RHEL, Router 1 drops the outgoing traffic instead of sending it to the Berlin network (**192.0.2.0/24**). However, regardless of the configured behavior, communication is not possible without the static route.



## NOTE

In addition to configuring the static routes, you must enable IP forwarding on both routers.

### Additional resources

- [Why cannot a server be pinged if net.ipv4.conf.all.rp\\_filter is set on the server?](#)
- [Enabling IP forwarding](#)

## 24.2. HOW TO USE THE NMCLI COMMAND TO CONFIGURE A STATIC ROUTE

To configure a static route, use the **nmcli** utility with the following syntax:

```
$ nmcli connection modify connection_name ipv4.routes "ip[/prefix] [next_hop] [metric] [attribute=value] [attribute=value] ..."
```

The command supports the following route attributes:

- **cwnd=*n***: Sets the congestion window (CWND) size, defined in number of packets.

- **lock-cwnd=true|false**: Defines whether or not the kernel can update the CWND value.
- **lock-mtu=true|false**: Defines whether or not the kernel can update the MTU to path MTU discovery.
- **lock-window=true|false**: Defines whether or not the kernel can update the maximum window size for TCP packets.
- **mtu=*n***: Sets the maximum transfer unit (MTU) to use along the path to the destination.
- **onlink=true|false**: Defines whether the next hop is directly attached to this link even if it does not match any interface prefix.
- **scope=*n***: For an IPv4 route, this attribute sets the scope of the destinations covered by the route prefix. Set the value as an integer (0-255).
- **src=*address***: Sets the source address to prefer when sending traffic to the destinations covered by the route prefix.
- **table=*table\_id***: Sets the ID of the table the route should be added to. If you omit this parameter, NetworkManager uses the **main** table.
- **tos=*n***: Sets the type of service (TOS) key. Set the value as an integer (0-255).
- **type=*value***: Sets the route type. NetworkManager supports the **unicast**, **local**, **blackhole**, **unreachable**, **prohibit**, and **throw** route types. The default is **unicast**.
- **window=*n***: Sets the maximal window size for TCP to advertise to these destinations, measured in bytes.

If you use the **ipv4.routes** sub-command, **nmcli** overrides all current settings of this parameter.

To add a route:

```
$ nmcli connection modify connection_name +ipv4.routes "<route>"
```

Similarly, to remove a specific route:

```
$ nmcli connection modify connection_name -ipv4.routes "<route>"
```

## 24.3. CONFIGURING A STATIC ROUTE BY USING NMCLI

You can add a static route to an existing NetworkManager connection profile using the **nmcli connection modify** command.

The procedure below configures the following routes:

- An IPv4 route to the remote **198.51.100.0/24** network. The corresponding gateway with the IP address **192.0.2.10** is reachable through the **example** connection.
- An IPv6 route to the remote **2001:db8:2::/64** network. The corresponding gateway with the IP address **2001:db8:1::10** is reachable through the **example** connection.

### Prerequisites

- The **example** connection profile exists and it configures this host to be in the same IP subnet as the gateways.

## Procedure

1. Add the static IPv4 route to the **example** connection profile:

```
# nmcli connection modify example +ipv4.routes "198.51.100.0/24 192.0.2.10"
```

To set multiple routes in one step, pass the individual routes comma-separated to the command. For example, to add a route to the **198.51.100.0/24** and **203.0.113.0/24** networks, both routed through the **192.0.2.10** gateway, enter:

```
# nmcli connection modify example +ipv4.routes "198.51.100.0/24 192.0.2.10,203.0.113.0/24 192.0.2.10"
```

2. Add the static IPv6 route to the **example** connection profile:

```
# nmcli connection modify example +ipv6.routes "2001:db8:2::/64 2001:db8:1::10"
```

3. Re-activate the connection:

```
# nmcli connection up example
```

## Verification

1. Display the IPv4 routes:

```
# ip -4 route
...
198.51.100.0/24 via 192.0.2.10 dev enp1s0
```

2. Display the IPv6 routes:

```
# ip -6 route
...
2001:db8:2::/64 via 2001:db8:1::10 dev enp1s0 metric 1024 pref medium
```

## Additional resources

- **nmcli(1)** man page
- **nm-settings-nmcli(5)** man page

## 24.4. CONFIGURING A STATIC ROUTE BY USING NMTUI

The **nmtui** application provides a text-based user interface for NetworkManager. You can use **nmtui** to configure static routes on a host without a graphical interface.

For example, the procedure below adds a route to the **192.0.2.0/24** network that uses the gateway running on **198.51.100.1**, which is reachable through an existing connection profile.



## NOTE

In **nmtui**:

- Navigate by using the cursor keys.
- Press a button by selecting it and hitting **Enter**.
- Select and deselect checkboxes by using **Space**.

## Prerequisites

- The network is configured.
- The gateway for the static route must be directly reachable on the interface.
- If the user is logged in on a physical console, user permissions are sufficient. Otherwise, the command requires root permissions.

## Procedure

1. Start **nmtui**:

```
# nmtui
```

2. Select **Edit a connection**, and press **Enter**.
3. Select the connection profile through which you can reach the next hop to the destination network, and press **Enter**.
4. Depending on whether it is an IPv4 or IPv6 route, press the **Show** button next to the protocol's configuration area.
5. Press the **Edit** button next to **Routing**. This opens a new window where you configure static routes:
  - a. Press the **Add** button and fill in:
    - The destination network, including the prefix in Classless Inter-Domain Routing (CIDR) format
    - The IP address of the next hop
    - A metric value, if you add multiple routes to the same network and want to prioritize the routes by efficiency
  - b. Repeat the previous step for every route you want to add and that is reachable through this connection profile.
  - c. Press the **OK** button to return to the window with the connection settings.

Figure 24.1. Example of a static route without metric

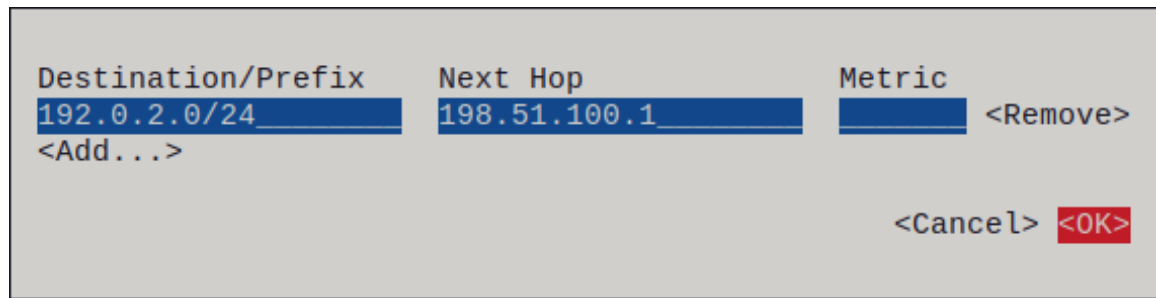

6. Press the **OK** button to return to the **nmtui** main menu.
7. Select **Activate a connection** and press **Enter**.
8. Select the connection profile that you edited, and press **Enter** twice to deactivate and activate it again.

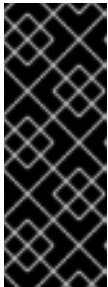

### IMPORTANT

Skip this step if you run **nmtui** over a remote connection, such as SSH, that uses the connection profile you want to reactivate. In this case, if you would deactivate it in **nmtui**, the connection is terminated and, consequently, you cannot activate it again. To avoid this problem, use the **nmcli connection connection\_profile\_name up** command to reactivate the connection in the mentioned scenario.

9. Press the **Back** button to return to the main menu.
10. Select **Quit**, and press **Enter** to close the **nmtui** application.

### Verification

- Verify that the route is active:

```
$ ip route
...
192.0.2.0/24 via 198.51.100.1 dev example proto static metric 100
```

## 24.5. CONFIGURING A STATIC ROUTE BY USING CONTROL-CENTER

You can use **control-center** in GNOME to add a static route to the configuration of a network connection.

The procedure below configures the following routes:

- An IPv4 route to the remote **198.51.100.0/24** network. The corresponding gateway has the IP address **192.0.2.10**.
- An IPv6 route to the remote **2001:db8:2::/64** network. The corresponding gateway has the IP address **2001:db8:1::10**.

### Prerequisites

- The network is configured.

- This host is in the same IP subnet as the gateways.
- The network configuration of the connection is opened in the **control-center** application. See [Configuring an Ethernet connection by using nm-connection-editor](#).

## Procedure

1. On the **IPv4** tab:
  - a. Optional: Disable automatic routes by clicking the **On** button in the **Routes** section of the **IPv4** tab to use only static routes. If automatic routes are enabled, Red Hat Enterprise Linux uses static routes and routes received from a DHCP server.
  - b. Enter the address, netmask, gateway, and optionally a metric value of the IPv4 route:

Routes				Automatic <input checked="" type="checkbox"/>
Address	Netmask	Gateway	Metric	
198.51.100.0	24	192.0.2.10		<input type="checkbox"/>

2. On the **IPv6** tab:
  - a. Optional: Disable automatic routes by clicking the **On** button in the **Routes** section of the **IPv4** tab to use only static routes.
  - b. Enter the address, netmask, gateway, and optionally a metric value of the IPv6 route:

Routes				Automatic <input checked="" type="checkbox"/>
Address	Prefix	Gateway	Metric	
2001:db8:2::	64	2001:db8:1::10		<input type="checkbox"/>

3. Click **Apply**.
4. Back in the **Network** window, disable and re-enable the connection by switching the button for the connection to **Off** and back to **On** for changes to take effect.



### WARNING

Restarting the connection briefly disrupts connectivity on that interface.

## Verification

1. Display the IPv4 routes:

```
# ip -4 route
...
198.51.100.0/24 via 192.0.2.10 dev enp1s0
```

2. Display the IPv6 routes:



```
# ip -6 route
```

```
...
2001:db8:2::/64 via 2001:db8:1::10 dev enp1s0 metric 1024 pref medium
```

## 24.6. CONFIGURING A STATIC ROUTE BY USING NM-CONNECTION-EDITOR

You can use the **nm-connection-editor** application to add a static route to the configuration of a network connection.

The procedure below configures the following routes:

- An IPv4 route to the remote **198.51.100.0/24** network. The corresponding gateway with the IP address **192.0.2.10** is reachable through the **example** connection.
- An IPv6 route to the remote **2001:db8:2::/64** network. The corresponding gateway with the IP address **2001:db8:1::10** is reachable through the **example** connection.

### Prerequisites

- The network is configured.
- This host is in the same IP subnet as the gateways.

### Procedure

1. Open a terminal, and enter **nm-connection-editor**:

```
$ nm-connection-editor
```

2. Select the **example** connection profile, and click the gear wheel icon to edit the existing connection.
3. On the **IPv4 Settings** tab:
  - a. Click the **Routes** button.
  - b. Click the **Add** button and enter the address, netmask, gateway, and optionally a metric value.

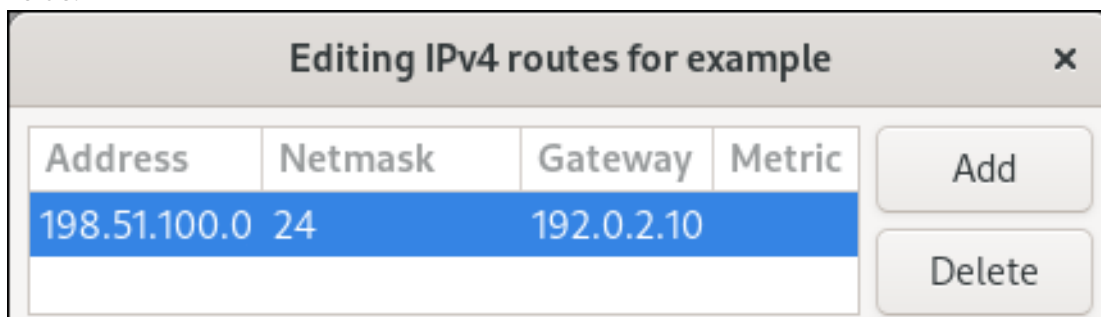

- c. Click **OK**.
4. On the **IPv6 Settings** tab:
    - a. Click the **Routes** button.

- b. Click the **Add** button and enter the address, netmask, gateway, and optionally a metric value.

Address	Prefix	Gateway	Metric
2001:db8:2::64	64	2001:db8:1::10	

- c. Click **OK**.
5. Click **Save**.
6. Restart the network connection for changes to take effect. For example, to restart the **example** connection using the command line:

```
# nmcli connection up example
```

### Verification

1. Display the IPv4 routes:

```
# ip -4 route
...
198.51.100.0/24 via 192.0.2.10 dev enp1s0
```

2. Display the IPv6 routes:

```
# ip -6 route
...
2001:db8:2::/64 via 2001:db8:1::10 dev enp1s0 metric 1024 pref medium
```

## 24.7. CONFIGURING A STATIC ROUTE BY USING THE NMCLI INTERACTIVE MODE

You can use the interactive mode of the **nmcli** utility to add a static route to the configuration of a network connection.

The procedure below configures the following routes:

- An IPv4 route to the remote **198.51.100.0/24** network. The corresponding gateway with the IP address **192.0.2.10** is reachable through the **example** connection.
- An IPv6 route to the remote **2001:db8:2::/64** network. The corresponding gateway with the IP address **2001:db8:1::10** is reachable through the **example** connection.

### Prerequisites

- The **example** connection profile exists and it configures this host to be in the same IP subnet as the gateways.

## Procedure

1. Open the **nmcli** interactive mode for the **example** connection:

```
# nmcli connection edit example
```

2. Add the static IPv4 route:

```
nmcli> set ipv4.routes 198.51.100.0/24 192.0.2.10
```

3. Add the static IPv6 route:

```
nmcli> set ipv6.routes 2001:db8:2::/64 2001:db8:1::10
```

4. Optionally, verify that the routes were added correctly to the configuration:

```
nmcli> print
...
ipv4.routes: { ip = 198.51.100.0/24, nh = 192.0.2.10 }
...
ipv6.routes: { ip = 2001:db8:2::/64, nh = 2001:db8:1::10 }
...
```

The **ip** attribute displays the network to route and the **nh** attribute the gateway (next hop).

5. Save the configuration:

```
nmcli> save persistent
```

6. Restart the network connection:

```
nmcli> activate example
```

7. Leave the **nmcli** interactive mode:

```
nmcli> quit
```

## Verification

1. Display the IPv4 routes:

```
# ip -4 route
...
198.51.100.0/24 via 192.0.2.10 dev enp1s0
```

2. Display the IPv6 routes:

```
# ip -6 route
...
2001:db8:2::/64 via 2001:db8:1::10 dev enp1s0 metric 1024 pref medium
```

## Additional resources

- **nmcli(1)** man page
- **nm-settings-nmcli(5)** man page

## 24.8. CONFIGURING A STATIC ROUTE BY USING NMSTATECTL

Use the **nmstatectl** utility to configure a static route through the Nmstate API. The Nmstate API ensures that, after setting the configuration, the result matches the configuration file. If anything fails, **nmstatectl** automatically rolls back the changes to avoid leaving the system in an incorrect state.

### Prerequisites

- The **enp1s0** network interface is configured and is in the same IP subnet as the gateways.
- The **nmstate** package is installed.

### Procedure

1. Create a YAML file, for example **~/add-static-route-to-enp1s0.yml**, with the following content:

```
---
routes:
  config:
    - destination: 198.51.100.0/24
      next-hop-address: 192.0.2.10
      next-hop-interface: enp1s0
    - destination: 2001:db8:2::/64
      next-hop-address: 2001:db8:1::10
      next-hop-interface: enp1s0
```

These settings define the following static routes:

- An IPv4 route to the remote **198.51.100.0/24** network. The corresponding gateway with the IP address **192.0.2.10** is reachable through the **enp1s0** interface.
  - An IPv6 route to the remote **2001:db8:2::/64** network. The corresponding gateway with the IP address **2001:db8:1::10** is reachable through the **enp1s0** interface.
2. Apply the settings to the system:

```
# nmstatectl apply ~/add-static-route-to-enp1s0.yml
```

### Verification

1. Display the IPv4 routes:

```
# ip -4 route
...
198.51.100.0/24 via 192.0.2.10 dev enp1s0
```

2. Display the IPv6 routes:

```
# ip -6 route
```

```
...
2001:db8:2::/64 via 2001:db8:1::10 dev enp1s0 metric 1024 pref medium
```

### Additional resources

- [nmstatectl\(8\)](#) man page
- [/usr/share/doc/nmstate/examples/](#) directory

## 24.9. CONFIGURING A STATIC ROUTE BY USING THE NETWORK RHEL SYSTEM ROLE

You can use the **network** RHEL system role to configure static routes.



### IMPORTANT

When you run a play that uses the **network** RHEL system role and if the setting values do not match the values specified in the play, the role overrides the existing connection profile with the same name. To prevent resetting these values to their defaults, always specify the whole configuration of the network connection profile in the play, even if the configuration, for example the IP configuration, already exists.

### Prerequisites

- [You have prepared the control node and the managed nodes](#)
- You are logged in to the control node as a user who can run playbooks on the managed nodes.
- The account you use to connect to the managed nodes has **sudo** permissions on them.

### Procedure

1. Create a playbook file, for example `~/playbook.yml`, with the following content:

```
---
- name: Configure the network
  hosts: managed-node-01.example.com
  tasks:
    - name: Configure an Ethernet connection with static IP and additional routes
      ansible.builtin.include_role:
        name: rhel-system-roles.network
      vars:
        network_connections:
          - name: enp7s0
            type: ethernet
            autoconnect: yes
            ip:
              address:
                - 192.0.2.1/24
                - 2001:db8:1::1/64
              gateway4: 192.0.2.254
              gateway6: 2001:db8:1::ffe
            dns:
```

```

- 192.0.2.200
- 2001:db8:1::ffbb
dns_search:
- example.com
route:
- network: 198.51.100.0
  prefix: 24
  gateway: 192.0.2.10
- network: 2001:db8:2::
  prefix: 64
  gateway: 2001:db8:1::10
state: up

```

Depending on whether it already exists, the procedure creates or updates the **enp7s0** connection profile with the following settings:

- A static IPv4 address - **192.0.2.1** with a **/24** subnet mask
- A static IPv6 address - **2001:db8:1::1** with a **/64** subnet mask
- An IPv4 default gateway - **192.0.2.254**
- An IPv6 default gateway - **2001:db8:1::ffe**
- An IPv4 DNS server - **192.0.2.200**
- An IPv6 DNS server - **2001:db8:1::ffbb**
- A DNS search domain - **example.com**
- Static routes:
  - **198.51.100.0/24** with gateway **192.0.2.10**
  - **2001:db8:2::/64** with gateway **2001:db8:1::10**

2. Validate the playbook syntax:

```
$ ansible-playbook --syntax-check ~/playbook.yml
```

Note that this command only validates the syntax and does not protect against a wrong but valid configuration.

3. Run the playbook:

```
$ ansible-playbook ~/playbook.yml
```

## Verification

1. On the managed nodes:

a. Display the IPv4 routes:

```

# ip -4 route
...
198.51.100.0/24 via 192.0.2.10 dev enp7s0

```

b. Display the IPv6 routes:

```
# ip -6 route
...
2001:db8:2::/64 via 2001:db8:1::10 dev enp7s0 metric 1024 pref medium
```

#### Additional resources

- `/usr/share/ansible/roles/rhel-system-roles.network/README.md` file
- `/usr/share/doc/rhel-system-roles/network/` directory

## 24.10. CREATING STATIC ROUTES CONFIGURATION FILES IN KEY-VALUE FORMAT WHEN USING THE LEGACY NETWORK SCRIPTS

The legacy network scripts support setting static routes in key-value format.

The procedure below configures an IPv4 route to the remote **198.51.100.0/24** network. The corresponding gateway with the IP address **192.0.2.10** is reachable through the **enp1s0** interface.



### NOTE

The legacy network scripts support the key-value format only for static IPv4 routes. For IPv6 routes, use the **ip**-command format. See [Creating static routes configuration files in ip-command format when using the legacy network scripts](#).

#### Prerequisites

- The gateways for the static route must be directly reachable on the interface.
- The **NetworkManager** package is not installed, or the **NetworkManager** service is disabled.
- The **network-scripts** package is installed.
- The **network** service is enabled.

#### Procedure

1. Add the static IPv4 route to the `/etc/sysconfig/network-scripts/route-enp0s1` file:

```
ADDRESS0=198.51.100.0
NETMASK0=255.255.255.0
GATEWAY0=192.0.2.10
```

- The **ADDRESS0** variable defines the network of the first routing entry.
- The **NETMASK0** variable defines the netmask of the first routing entry.
- The **GATEWAY0** variable defines the IP address of the gateway to the remote network or host for the first routing entry.  
If you add multiple static routes, increase the number in the variable names. Note that the variables for each route must be numbered sequentially. For example, **ADDRESS0**, **ADDRESS1**, **ADDRESS3**, and so on.

- Restart the network:

```
# systemctl restart network
```

### Verification

- Display the IPv4 routes:

```
# ip -4 route
...
198.51.100.0/24 via 192.0.2.10 dev enp1s0
```

### Troubleshooting

- Display the journal entries of the **network** unit:

```
# journalctl -u network
```

The following are possible error messages and their causes:

- **Error: Nexthop has invalid gateway:** You specified an IPv4 gateway address in the **route-*enp1s0*** file that is not in the same subnet as this router.
- **RTNETLINK answers: No route to host:** You specified an IPv6 gateway address in the **route6-*enp1s0*** file that is not in the same subnet as this router.
- **Error: Invalid prefix for given prefix length:** You specified the remote network in the **route-*enp1s0*** file by using an IP address within the remote network rather than the network address.

### Additional resources

- [/usr/share/doc/network-scripts/sysconfig.txt](#) file

## 24.11. CREATING STATIC ROUTES CONFIGURATION FILES IN IP-COMMAND FORMAT WHEN USING THE LEGACY NETWORK SCRIPTS

The legacy network scripts support setting static routes.

The procedure below configures the following routes:

- An IPv4 route to the remote **198.51.100.0/24** network. The corresponding gateway with the IP address **192.0.2.10** is reachable through the **enp1s0** interface.
- An IPv6 route to the remote **2001:db8:2::/64** network. The corresponding gateway with the IP address **2001:db8:1::10** is reachable through the **enp1s0** interface.

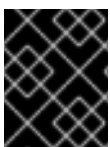

### IMPORTANT

IP addresses of the gateways (next hop) must be in the same IP subnet as the host on which you configure the static routes.

The examples in this procedure use configuration entries in **ip**-command format.



## Prerequisites

- The gateways for the static route must be directly reachable on the interface.
- The **NetworkManager** package is not installed, or the **NetworkManager** service is disabled.
- The **network-scripts** package is installed.
- The **network** service is enabled.

## Procedure

1. Add the static IPv4 route to the `/etc/sysconfig/network-scripts/route-enp1s0` file:

```
198.51.100.0/24 via 192.0.2.10 dev enp1s0
```

Always specify the network address of the remote network, such as **198.51.100.0**. Setting an IP address within the remote network, such as **198.51.100.1** causes that the network scripts fail to add this route.

2. Add the static IPv6 route to the `/etc/sysconfig/network-scripts/route6-enp1s0` file:

```
2001:db8:2::/64 via 2001:db8:1::10 dev enp1s0
```

3. Restart the **network** service:

```
# systemctl restart network
```

## Verification

1. Display the IPv4 routes:

```
# ip -4 route
...
198.51.100.0/24 via 192.0.2.10 dev enp1s0
```

2. Display the IPv6 routes:

```
# ip -6 route
...
2001:db8:2::/64 via 2001:db8:1::10 dev enp1s0 metric 1024 pref medium
```

## Troubleshooting

- Display the journal entries of the **network** unit:

```
# journalctl -u network
```

The following are possible error messages and their causes:

- **Error: Nexthop has invalid gateway:** You specified an IPv4 gateway address in the `route-enp1s0` file that is not in the same subnet as this router.

- **RTNETLINK answers: No route to host:** You specified an IPv6 gateway address in the **route6-*enp1s0*** file that is not in the same subnet as this router.
- **Error: Invalid prefix for given prefix length:** You specified the remote network in the **route-*enp1s0*** file by using an IP address within the remote network rather than the network address.

#### Additional Resources

- **`/usr/share/doc/network-scripts/sysconfig.txt`** file

## CHAPTER 25. CONFIGURING POLICY-BASED ROUTING TO DEFINE ALTERNATIVE ROUTES

By default, the kernel in RHEL decides where to forward network packets based on the destination address using a routing table. Policy-based routing enables you to configure complex routing scenarios. For example, you can route packets based on various criteria, such as the source address, packet metadata, or protocol.



### NOTE

On systems that use NetworkManager, only the **nmcli** utility supports setting routing rules and assigning routes to specific tables.

### 25.1. ROUTING TRAFFIC FROM A SPECIFIC SUBNET TO A DIFFERENT DEFAULT GATEWAY BY USING NMCLI

You can use policy-based routing to configure a different default gateway for traffic from certain subnets. For example, you can configure RHEL as a router that, by default, routes all traffic to internet provider A using the default route. However, traffic received from the internal workstations subnet is routed to provider B.

The procedure assumes the following network topology:

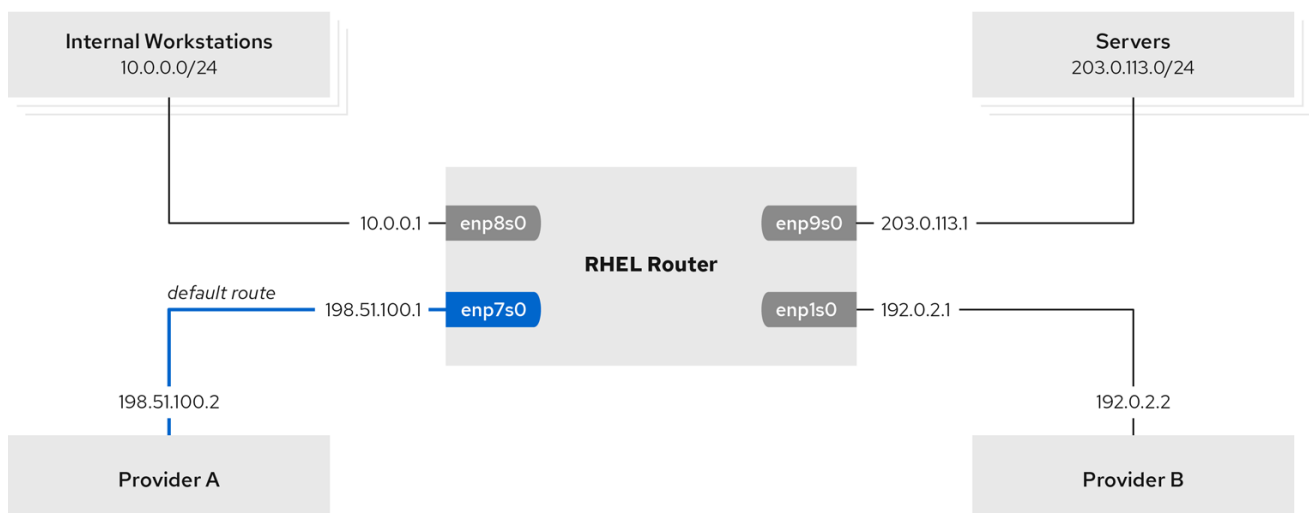

60\_RHEL\_0120

#### Prerequisites

- The system uses **NetworkManager** to configure the network, which is the default.
- The RHEL router you want to set up in the procedure has four network interfaces:
  - The **enp7s0** interface is connected to the network of provider A. The gateway IP in the provider's network is **198.51.100.2**, and the network uses a **/30** network mask.
  - The **enp1s0** interface is connected to the network of provider B. The gateway IP in the provider's network is **192.0.2.2**, and the network uses a **/30** network mask.
  - The **enp8s0** interface is connected to the **10.0.0.0/24** subnet with internal workstations.

- The **enp9s0** interface is connected to the **203.0.113.0/24** subnet with the company's servers.
- Hosts in the internal workstations subnet use **10.0.0.1** as the default gateway. In the procedure, you assign this IP address to the **enp8s0** network interface of the router.
- Hosts in the server subnet use **203.0.113.1** as the default gateway. In the procedure, you assign this IP address to the **enp9s0** network interface of the router.
- The **firewalld** service is enabled and active.

## Procedure

1. Configure the network interface to provider A:

```
# nmcli connection add type ethernet con-name Provider-A ifname enp7s0
ipv4.method manual ipv4.addresses 198.51.100.1/30 ipv4.gateway 198.51.100.2
ipv4.dns 198.51.100.200 connection.zone external
```

The **nmcli connection add** command creates a NetworkManager connection profile. The command uses the following options:

- **type ethernet**: Defines that the connection type is Ethernet.
  - **con-name *connection\_name***: Sets the name of the profile. Use a meaningful name to avoid confusion.
  - **ifname *network\_device***: Sets the network interface.
  - **ipv4.method manual**: Enables to configure a static IP address.
  - **ipv4.addresses *IP\_address/subnet\_mask***: Sets the IPv4 addresses and subnet mask.
  - **ipv4.gateway *IP\_address***: Sets the default gateway address.
  - **ipv4.dns *IP\_of\_DNS\_server***: Sets the IPv4 address of the DNS server.
  - **connection.zone *firewalld\_zone***: Assigns the network interface to the defined **firewalld** zone. Note that **firewalld** automatically enables masquerading for interfaces assigned to the **external** zone.
2. Configure the network interface to provider B:

```
# nmcli connection add type ethernet con-name Provider-B ifname enp1s0
ipv4.method manual ipv4.addresses 192.0.2.1/30 ipv4.routes "0.0.0.0/0 192.0.2.2
table=5000" connection.zone external
```

This command uses the **ipv4.routes** parameter instead of **ipv4.gateway** to set the default gateway. This is required to assign the default gateway for this connection to a different routing table (**5000**) than the default. NetworkManager automatically creates this new routing table when the connection is activated.

3. Configure the network interface to the internal workstations subnet:

```
# nmcli connection add type ethernet con-name Internal-Workstations ifname enp8s0
ipv4.method manual ipv4.addresses 10.0.0.1/24 ipv4.routes "10.0.0.0/24 table=5000"
ipv4.routing-rules "priority 5 from 10.0.0.0/24 table 5000" connection.zone trusted
```

This command uses the **ipv4.routes** parameter to add a static route to the routing table with ID **5000**. This static route for the **10.0.0.0/24** subnet uses the IP of the local network interface to provider B (**192.0.2.1**) as next hop.

Additionally, the command uses the **ipv4.routing-rules** parameter to add a routing rule with priority **5** that routes traffic from the **10.0.0.0/24** subnet to table **5000**. Low values have a high priority.

Note that the syntax in the **ipv4.routing-rules** parameter is the same as in an **ip rule add** command, except that **ipv4.routing-rules** always requires specifying a priority.

4. Configure the network interface to the server subnet:

```
# nmcli connection add type ethernet con-name Servers ifname enp9s0 ipv4.method
manual ipv4.addresses 203.0.113.1/24 connection.zone trusted
```

## Verification

1. On a RHEL host in the internal workstation subnet:
  - a. Install the **traceroute** package:

```
# yum install traceroute
```

- b. Use the **traceroute** utility to display the route to a host on the internet:

```
# traceroute redhat.com
traceroute to redhat.com (209.132.183.105), 30 hops max, 60 byte packets
 1 10.0.0.1 (10.0.0.1)  0.337 ms 0.260 ms 0.223 ms
 2 192.0.2.1 (192.0.2.1) 0.884 ms 1.066 ms 1.248 ms
 ...
```

The output of the command displays that the router sends packets over **192.0.2.1**, which is the network of provider B.

2. On a RHEL host in the server subnet:
  - a. Install the **traceroute** package:

```
# yum install traceroute
```

- b. Use the **traceroute** utility to display the route to a host on the internet:

```
# traceroute redhat.com
traceroute to redhat.com (209.132.183.105), 30 hops max, 60 byte packets
 1 203.0.113.1 (203.0.113.1) 2.179 ms 2.073 ms 1.944 ms
 2 198.51.100.2 (198.51.100.2) 1.868 ms 1.798 ms 1.549 ms
 ...
```

The output of the command displays that the router sends packets over **198.51.100.2**, which is the network of provider A.

## Troubleshooting steps

On the RHEL router:

1. Display the rule list:

```
# ip rule list
0: from all lookup local
5: from 10.0.0.0/24 lookup 5000
32766: from all lookup main
32767: from all lookup default
```

By default, RHEL contains rules for the tables **local**, **main**, and **default**.

2. Display the routes in table **5000**:

```
# ip route list table 5000
0.0.0.0/0 via 192.0.2.2 dev enp1s0 proto static metric 100
10.0.0.0/24 dev enp8s0 proto static scope link src 192.0.2.1 metric 102
```

3. Display the interfaces and firewall zones:

```
# firewall-cmd --get-active-zones
external
  interfaces: enp1s0 enp7s0
trusted
  interfaces: enp8s0 enp9s0
```

4. Verify that the **external** zone has masquerading enabled:

```
# firewall-cmd --info-zone=external
external (active)
target: default
icmp-block-inversion: no
interfaces: enp1s0 enp7s0
sources:
services: ssh
ports:
protocols:
masquerade: yes
...
```

## Additional resources

- **nm-settings(5)** man page
- **nmcli(1)** man page
- [Is it possible to set up Policy Based Routing with NetworkManager in RHEL?](#)

## 25.2. ROUTING TRAFFIC FROM A SPECIFIC SUBNET TO A DIFFERENT DEFAULT GATEWAY BY USING THE NETWORK RHEL SYSTEM ROLE

You can use policy-based routing to configure a different default gateway for traffic from certain subnets. For example, you can configure RHEL as a router that, by default, routes all traffic to internet provider A using the default route. However, traffic received from the internal workstations subnet is routed to provider B.

To configure policy-based routing remotely and on multiple nodes, you can use the **network** RHEL system role.

This procedure assumes the following network topology:

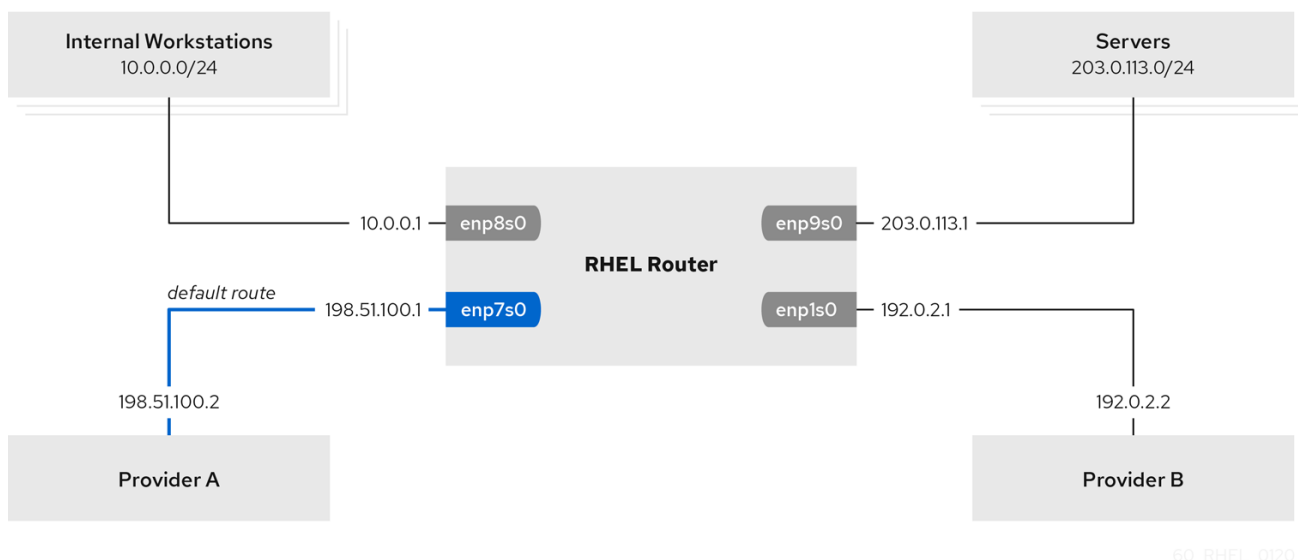

### Prerequisites

- [You have prepared the control node and the managed nodes](#)
- You are logged in to the control node as a user who can run playbooks on the managed nodes.
- The account you use to connect to the managed nodes has **sudo** permissions on them.
- The managed nodes uses the **NetworkManager** and **firewalld** services.
- The managed nodes you want to configure has four network interfaces:
  - The **enp7s0** interface is connected to the network of provider A. The gateway IP in the provider's network is **198.51.100.2**, and the network uses a **/30** network mask.
  - The **enp1s0** interface is connected to the network of provider B. The gateway IP in the provider's network is **192.0.2.2**, and the network uses a **/30** network mask.
  - The **enp8s0** interface is connected to the **10.0.0.0/24** subnet with internal workstations.
  - The **enp9s0** interface is connected to the **203.0.113.0/24** subnet with the company's servers.
- Hosts in the internal workstations subnet use **10.0.0.1** as the default gateway. In the procedure, you assign this IP address to the **enp8s0** network interface of the router.

- Hosts in the server subnet use **203.0.113.1** as the default gateway. In the procedure, you assign this IP address to the **enp9s0** network interface of the router.

## Procedure

1. Create a playbook file, for example `~/playbook.yml`, with the following content:

```
---
- name: Configuring policy-based routing
  hosts: managed-node-01.example.com
  tasks:
    - name: Routing traffic from a specific subnet to a different default gateway
      ansible.builtin.include_role:
        name: rhel-system-roles.network
      vars:
        network_connections:
          - name: Provider-A
            interface_name: enp7s0
            type: ethernet
            autoconnect: True
            ip:
              address:
                - 198.51.100.1/30
              gateway4: 198.51.100.2
              dns:
                - 198.51.100.200
            state: up
            zone: external

          - name: Provider-B
            interface_name: enp1s0
            type: ethernet
            autoconnect: True
            ip:
              address:
                - 192.0.2.1/30
              route:
                - network: 0.0.0.0
                  prefix: 0
                  gateway: 192.0.2.2
                  table: 5000
            state: up
            zone: external

          - name: Internal-Workstations
            interface_name: enp8s0
            type: ethernet
            autoconnect: True
            ip:
              address:
                - 10.0.0.1/24
              route:
                - network: 10.0.0.0
                  prefix: 24
                  table: 5000
            routing_rule:
```



```

- priority: 5
  from: 10.0.0.0/24
  table: 5000
state: up
zone: trusted

- name: Servers
  interface_name: enp9s0
  type: ethernet
  autoconnect: True
  ip:
    address:
      - 203.0.113.1/24
state: up
zone: trusted

```

2. Validate the playbook syntax:

```
$ ansible-playbook --syntax-check ~/playbook.yml
```

Note that this command only validates the syntax and does not protect against a wrong but valid configuration.

3. Run the playbook:

```
$ ansible-playbook ~/playbook.yml
```

## Verification

1. On a RHEL host in the internal workstation subnet:

- a. Install the **traceroute** package:

```
# yum install traceroute
```

- b. Use the **traceroute** utility to display the route to a host on the internet:

```
# traceroute redhat.com
traceroute to redhat.com (209.132.183.105), 30 hops max, 60 byte packets
 1 10.0.0.1 (10.0.0.1)  0.337 ms  0.260 ms  0.223 ms
 2 192.0.2.1 (192.0.2.1) 0.884 ms 1.066 ms 1.248 ms
 ...
```

The output of the command displays that the router sends packets over **192.0.2.1**, which is the network of provider B.

2. On a RHEL host in the server subnet:

- a. Install the **traceroute** package:

```
# yum install traceroute
```

- b. Use the **traceroute** utility to display the route to a host on the internet:

**# traceroute redhat.com**

```
traceroute to redhat.com (209.132.183.105), 30 hops max, 60 byte packets
 1 203.0.113.1 (203.0.113.1)  2.179 ms  2.073 ms  1.944 ms
 2 198.51.100.2 (198.51.100.2) 1.868 ms 1.798 ms 1.549 ms
 ...
```

The output of the command displays that the router sends packets over **198.51.100.2**, which is the network of provider A.

3. On the RHEL router that you configured using the RHEL system role:
  - a. Display the rule list:

**# ip rule list**

```
0:    from all lookup local
5:   from 10.0.0.0/24 lookup 5000
32766: from all lookup main
32767: from all lookup default
```

By default, RHEL contains rules for the tables **local**, **main**, and **default**.

- b. Display the routes in table **5000**:

**# ip route list table 5000**

```
0.0.0.0/0 via 192.0.2.2 dev enp1s0 proto static metric 100
10.0.0.0/24 dev enp8s0 proto static scope link src 192.0.2.1 metric 102
```

- c. Display the interfaces and firewall zones:

**# firewall-cmd --get-active-zones**

```
external
  interfaces: enp1s0 enp7s0
trusted
  interfaces: enp8s0 enp9s0
```

- d. Verify that the **external** zone has masquerading enabled:

**# firewall-cmd --info-zone=external**

```
external (active)
target: default
icmp-block-inversion: no
interfaces: enp1s0 enp7s0
sources:
services: ssh
ports:
protocols:
masquerade: yes
...
```

**Additional resources**

- `/usr/share/ansible/roles/rhel-system-roles.network/README.md` file
- `/usr/share/doc/rhel-system-roles/network/` directory

## 25.3. OVERVIEW OF CONFIGURATION FILES INVOLVED IN POLICY-BASED ROUTING WHEN USING THE LEGACY NETWORK SCRIPTS

If you use the legacy network scripts instead of NetworkManager to configure your network, you can also configure policy-based routing.



### NOTE

Configuring the network using the legacy network scripts provided by the **network-scripts** package is deprecated in RHEL 8. Red Hat recommends that you use NetworkManager to configure policy-based routing. For an example, see [Routing traffic from a specific subnet to a different default gateway by using nmcli](#).

The following configuration files are involved in policy-based routing when you use the legacy network scripts:

- **/etc/sysconfig/network-scripts/route-interface**: This file defines the IPv4 routes. Use the **table** option to specify the routing table. For example:

```
192.0.2.0/24 via 198.51.100.1 table 1
203.0.113.0/24 via 198.51.100.2 table 2
```

- **/etc/sysconfig/network-scripts/route6-interface**: This file defines the IPv6 routes.
- **/etc/sysconfig/network-scripts/rule-interface**: This file defines the rules for IPv4 source networks for which the kernel routes traffic to specific routing tables. For example:

```
from 192.0.2.0/24 lookup 1
from 203.0.113.0/24 lookup 2
```

- **/etc/sysconfig/network-scripts/rule6-interface**: This file defines the rules for IPv6 source networks for which the kernel routes traffic to specific routing tables.
- **/etc/iproute2/rt\_tables**: This file defines the mappings if you want to use names instead of numbers to refer to specific routing tables. For example:

```
1 Provider_A
2 Provider_B
```

### Additional resources

- **ip-route(8)** man page
- **ip-rule(8)** man page

## 25.4. ROUTING TRAFFIC FROM A SPECIFIC SUBNET TO A DIFFERENT DEFAULT GATEWAY BY USING THE LEGACY NETWORK SCRIPTS

You can use policy-based routing to configure a different default gateway for traffic from certain subnets. For example, you can configure RHEL as a router that, by default, routes all traffic to internet provider A using the default route. However, traffic received from the internal workstations subnet is routed to provider B.

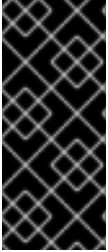

## IMPORTANT

Configuring the network using the legacy network scripts provided by the **network-scripts** package is deprecated in RHEL 8. Follow the procedure only if you use the legacy network scripts instead of NetworkManager on your host. If you use NetworkManager to manage your network settings, see [Routing traffic from a specific subnet to a different default gateway by using nmcli](#).

The procedure assumes the following network topology:

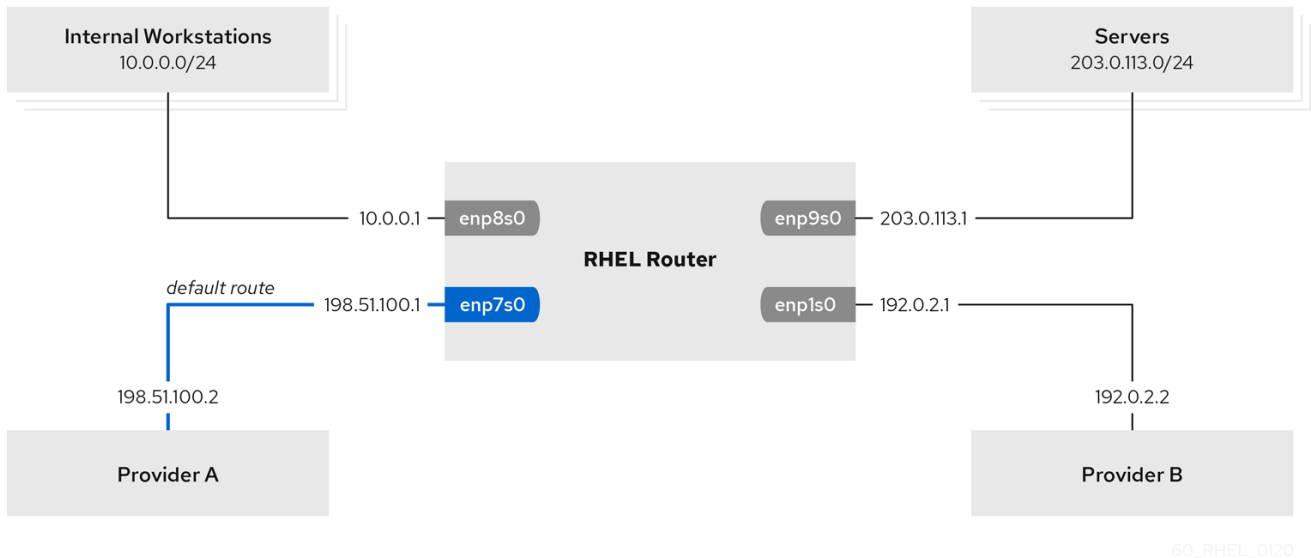

## NOTE

The legacy network scripts process configuration files in alphabetical order. Therefore, you must name the configuration files in a way that ensures that an interface, that is used in rules and routes of other interfaces, are up when a depending interface requires it. To accomplish the correct order, this procedure uses numbers in the **ifcfg-\***, **route-\***, and **rules-\*** files.

## Prerequisites

- The **NetworkManager** package is not installed, or the **NetworkManager** service is disabled.
- The **network-scripts** package is installed.
- The RHEL router you want to set up in the procedure has four network interfaces:
  - The **enp7s0** interface is connected to the network of provider A. The gateway IP in the provider's network is **198.51.100.2**, and the network uses a **/30** network mask.
  - The **enp1s0** interface is connected to the network of provider B. The gateway IP in the provider's network is **192.0.2.2**, and the network uses a **/30** network mask.
  - The **enp8s0** interface is connected to the **10.0.0.0/24** subnet with internal workstations.
  - The **enp9s0** interface is connected to the **203.0.113.0/24** subnet with the company's servers.

- Hosts in the internal workstations subnet use **10.0.0.1** as the default gateway. In the procedure, you assign this IP address to the **enp8s0** network interface of the router.
- Hosts in the server subnet use **203.0.113.1** as the default gateway. In the procedure, you assign this IP address to the **enp9s0** network interface of the router.
- The **firewalld** service is enabled and active.

## Procedure

1. Add the configuration for the network interface to provider A by creating the **/etc/sysconfig/network-scripts/ifcfg-1\_Provider-A** file with the following content:

```
TYPE=Ethernet
IPADDR=198.51.100.1
PREFIX=30
GATEWAY=198.51.100.2
DNS1=198.51.100.200
DEFROUTE=yes
NAME=1_Provider-A
DEVICE=enp7s0
ONBOOT=yes
ZONE=external
```

The configuration file uses the following parameters:

- **TYPE=Ethernet**: Defines that the connection type is Ethernet.
  - **IPADDR=IP\_address**: Sets the IPv4 address.
  - **PREFIX=subnet\_mask**: Sets the subnet mask.
  - **GATEWAY=IP\_address**: Sets the default gateway address.
  - **DNS1=IP\_of\_DNS\_server**: Sets the IPv4 address of the DNS server.
  - **DEFROUTE=yes/no**: Defines whether the connection is a default route or not.
  - **NAME=connection\_name**: Sets the name of the connection profile. Use a meaningful name to avoid confusion.
  - **DEVICE=network\_device**: Sets the network interface.
  - **ONBOOT=yes**: Defines that RHEL starts this connection when the system boots.
  - **ZONE=firewalld\_zone**: Assigns the network interface to the defined **firewalld** zone. Note that **firewalld** automatically enables masquerading for interfaces assigned to the **external** zone.
2. Add the configuration for the network interface to provider B:
    - a. Create the **/etc/sysconfig/network-scripts/ifcfg-2\_Provider-B** file with the following content:

```
TYPE=Ethernet
IPADDR=192.0.2.1
PREFIX=30
```

```
DEFROUTE=no
NAME=2_Provider-B
DEVICE=enp1s0
ONBOOT=yes
ZONE=external
```

Note that the configuration file for this interface does not contain a default gateway setting.

- b. Assign the gateway for the **2\_Provider-B** connection to a separate routing table. Therefore, create the `/etc/sysconfig/network-scripts/route-2_Provider-B` file with the following content:

```
0.0.0.0/0 via 192.0.2.2 table 5000
```

This entry assigns the gateway and traffic from all subnets routed through this gateway to table **5000**.

3. Create the configuration for the network interface to the internal workstations subnet:

- a. Create the `/etc/sysconfig/network-scripts/ifcfg-3_Internal-Workstations` file with the following content:

```
TYPE=Ethernet
IPADDR=10.0.0.1
PREFIX=24
DEFROUTE=no
NAME=3_Internal-Workstations
DEVICE=enp8s0
ONBOOT=yes
ZONE=internal
```

- b. Add the routing rule configuration for the internal workstation subnet. Therefore, create the `/etc/sysconfig/network-scripts/rule-3_Internal-Workstations` file with the following content:

```
pri 5 from 10.0.0.0/24 table 5000
```

This configuration defines a routing rule with priority **5** that routes all traffic from the **10.0.0.0/24** subnet to table **5000**. Low values have a high priority.

- c. Create the `/etc/sysconfig/network-scripts/route-3_Internal-Workstations` file with the following content to add a static route to the routing table with ID **5000**:

```
10.0.0.0/24 via 192.0.2.1 table 5000
```

This static route defines that RHEL sends traffic from the **10.0.0.0/24** subnet to the IP of the local network interface to provider B (**192.0.2.1**). This interface is to routing table **5000** and used as the next hop.

4. Add the configuration for the network interface to the server subnet by creating the `/etc/sysconfig/network-scripts/ifcfg-4_Servers` file with the following content:

```
TYPE=Ethernet
IPADDR=203.0.113.1
```

```
PREFIX=24
DEFROUTE=no
NAME=4_Servers
DEVICE=enp9s0
ONBOOT=yes
ZONE=internal
```

5. Restart the network:

```
# systemctl restart network
```

## Verification

1. On a RHEL host in the internal workstation subnet:

- a. Install the **traceroute** package:

```
# yum install traceroute
```

- b. Use the **traceroute** utility to display the route to a host on the internet:

```
# traceroute redhat.com
traceroute to redhat.com (209.132.183.105), 30 hops max, 60 byte packets
 1 10.0.0.1 (10.0.0.1)  0.337 ms 0.260 ms 0.223 ms
 2 192.0.2.1 (192.0.2.1) 0.884 ms 1.066 ms 1.248 ms
 ...
```

The output of the command displays that the router sends packets over **192.0.2.1**, which is the network of provider B.

2. On a RHEL host in the server subnet:

- a. Install the **traceroute** package:

```
# yum install traceroute
```

- b. Use the **traceroute** utility to display the route to a host on the internet:

```
# traceroute redhat.com
traceroute to redhat.com (209.132.183.105), 30 hops max, 60 byte packets
 1 203.0.113.1 (203.0.113.1) 2.179 ms 2.073 ms 1.944 ms
 2 198.51.100.2 (198.51.100.2) 1.868 ms 1.798 ms 1.549 ms
 ...
```

The output of the command displays that the router sends packets over **198.51.100.2**, which is the network of provider A.

## Troubleshooting steps

On the RHEL router:

1. Display the rule list:

```
# ip rule list
0:    from all lookup local
```

```
5: from 10.0.0.0/24 lookup 5000
```

```
32766: from all lookup main
```

```
32767: from all lookup default
```

By default, RHEL contains rules for the tables **local**, **main**, and **default**.

2. Display the routes in table **5000**:

```
# ip route list table 5000
```

```
default via 192.0.2.2 dev enp1s0
```

```
10.0.0.0/24 via 192.0.2.1 dev enp1s0
```

3. Display the interfaces and firewall zones:

```
# firewall-cmd --get-active-zones
```

```
external
```

```
  interfaces: enp1s0 enp7s0
```

```
internal
```

```
  interfaces: enp8s0 enp9s0
```

4. Verify that the **external** zone has masquerading enabled:

```
# firewall-cmd --info-zone=external
```

```
external (active)
```

```
  target: default
```

```
  icmp-block-inversion: no
```

```
  interfaces: enp1s0 enp7s0
```

```
  sources:
```

```
  services: ssh
```

```
  ports:
```

```
  protocols:
```

```
  masquerade: yes
```

```
  ...
```

### Additional resources

- [Overview of configuration files involved in policy-based routing when using the legacy network scripts](#)
- **ip-route(8)** man page
- **ip-rule(8)** man page
- `/usr/share/doc/network-scripts/sysconfig.txt` file



## CHAPTER 26. REUSING THE SAME IP ADDRESS ON DIFFERENT INTERFACES

With Virtual routing and forwarding (VRF), administrators can use multiple routing tables simultaneously on the same host. For that, VRF partitions a network at layer 3. This enables the administrator to isolate traffic using separate and independent route tables per VRF domain. This technique is similar to virtual LANs (VLAN), which partitions a network at layer 2, where the operating system uses different VLAN tags to isolate traffic sharing the same physical medium.

One benefit of VRF over partitioning on layer 2 is that routing scales better considering the number of peers involved.

Red Hat Enterprise Linux uses a virtual **vrt** device for each VRF domain and adds routes to a VRF domain by adding existing network devices to a VRF device. Addresses and routes previously attached to the original device will be moved inside the VRF domain.

Note that each VRF domain is isolated from each other.

### 26.1. PERMANENTLY REUSING THE SAME IP ADDRESS ON DIFFERENT INTERFACES

You can use the virtual routing and forwarding (VRF) feature to permanently use the same IP address on different interfaces in one server.



#### IMPORTANT

To enable remote peers to contact both VRF interfaces while reusing the same IP address, the network interfaces must belong to different broadcasting domains. A broadcast domain in a network is a set of nodes, which receive broadcast traffic sent by any of them. In most configurations, all nodes connected to the same switch belong to the same broadcasting domain.

#### Prerequisites

- You are logged in as the **root** user.
- The network interfaces are not configured.

#### Procedure

1. Create and configure the first VRF device:
  - a. Create a connection for the VRF device and assign it to a routing table. For example, to create a VRF device named **vrf0** that is assigned to the **1001** routing table:

```
# nmcli connection add type vrf ifname vrf0 con-name vrf0 table 1001 ipv4.method disabled ipv6.method disabled
```

- b. Enable the **vrf0** device:

```
# nmcli connection up vrf0
```

- c. Assign a network device to the VRF just created. For example, to add the **enp1s0** Ethernet device to the **vrf0** VRF device and assign an IP address and the subnet mask to **enp1s0**, enter:

```
# nmcli connection add type ethernet con-name vrf.enp1s0 ifname enp1s0 master
vrf0 ipv4.method manual ipv4.address 192.0.2.1/24
```

- d. Activate the **vrf.enp1s0** connection:

```
# nmcli connection up vrf.enp1s0
```

2. Create and configure the next VRF device:

- a. Create the VRF device and assign it to a routing table. For example, to create a VRF device named **vrf1** that is assigned to the **1002** routing table, enter:

```
# nmcli connection add type vrf ifname vrf1 con-name vrf1 table 1002 ipv4.method
disabled ipv6.method disabled
```

- b. Activate the **vrf1** device:

```
# nmcli connection up vrf1
```

- c. Assign a network device to the VRF just created. For example, to add the **enp7s0** Ethernet device to the **vrf1** VRF device and assign an IP address and the subnet mask to **enp7s0**, enter:

```
# nmcli connection add type ethernet con-name vrf.enp7s0 ifname enp7s0 master
vrf1 ipv4.method manual ipv4.address 192.0.2.1/24
```

- d. Activate the **vrf.enp7s0** device:

```
# nmcli connection up vrf.enp7s0
```

## 26.2. TEMPORARILY REUSING THE SAME IP ADDRESS ON DIFFERENT INTERFACES

You can use the virtual routing and forwarding (VRF) feature to temporarily use the same IP address on different interfaces in one server. Use this procedure only for testing purposes, because the configuration is temporary and lost after you reboot the system.

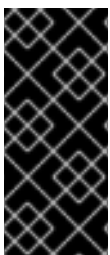

### IMPORTANT

To enable remote peers to contact both VRF interfaces while reusing the same IP address, the network interfaces must belong to different broadcasting domains. A broadcast domain in a network is a set of nodes which receive broadcast traffic sent by any of them. In most configurations, all nodes connected to the same switch belong to the same broadcasting domain.

### Prerequisites

- You are logged in as the **root** user.

- The network interfaces are not configured.

## Procedure

1. Create and configure the first VRF device:

- a. Create the VRF device and assign it to a routing table. For example, to create a VRF device named **blue** that is assigned to the **1001** routing table:

```
# ip link add dev blue type vrf table 1001
```

- b. Enable the **blue** device:

```
# ip link set dev blue up
```

- c. Assign a network device to the VRF device. For example, to add the **enp1s0** Ethernet device to the **blue** VRF device:

```
# ip link set dev enp1s0 master blue
```

- d. Enable the **enp1s0** device:

```
# ip link set dev enp1s0 up
```

- e. Assign an IP address and subnet mask to the **enp1s0** device. For example, to set it to **192.0.2.1/24**:

```
# ip addr add dev enp1s0 192.0.2.1/24
```

2. Create and configure the next VRF device:

- a. Create the VRF device and assign it to a routing table. For example, to create a VRF device named **red** that is assigned to the **1002** routing table:

```
# ip link add dev red type vrf table 1002
```

- b. Enable the **red** device:

```
# ip link set dev red up
```

- c. Assign a network device to the VRF device. For example, to add the **enp7s0** Ethernet device to the **red** VRF device:

```
# ip link set dev enp7s0 master red
```

- d. Enable the **enp7s0** device:

```
# ip link set dev enp7s0 up
```

- e. Assign the same IP address and subnet mask to the **enp7s0** device as you used for **enp1s0** in the **blue** VRF domain:

```
# ip addr add dev enp7s0 192.0.2.1/24
```

3. Optionally, create further VRF devices as described above.

## 26.3. ADDITIONAL RESOURCES

- `/usr/share/doc/kernel-doc-<kernel_version>/Documentation/networking/vrf.txt` from the `kernel-doc` package

## CHAPTER 27. STARTING A SERVICE WITHIN AN ISOLATED VRF NETWORK

With virtual routing and forwarding (VRF), you can create isolated networks with a routing table that is different to the main routing table of the operating system. You can then start services and applications so that they have only access to the network defined in that routing table.

### 27.1. CONFIGURING A VRF DEVICE

To use virtual routing and forwarding (VRF), you create a VRF device and attach a physical or virtual network interface and routing information to it.



#### WARNING

To prevent that you lock out yourself out remotely, perform this procedure on the local console or remotely over a network interface that you do not want to assign to the VRF device.

#### Prerequisites

- You are logged in locally or using a network interface that is different to the one you want to assign to the VRF device.

#### Procedure

- Create the **vrf0** connection with a same-named virtual device, and attach it to routing table **1000**:

```
# nmcli connection add type vrf ifname vrf0 con-name vrf0 table 1000 ipv4.method disabled ipv6.method disabled
```

- Add the **enp1s0** device to the **vrf0** connection, and configure the IP settings:

```
# nmcli connection add type ethernet con-name enp1s0 ifname enp1s0 master vrf0 ipv4.method manual ipv4.address 192.0.2.1/24 ipv4.gateway 192.0.2.254
```

This command creates the **enp1s0** connection as a port of the **vrf0** connection. Due to this configuration, the routing information are automatically assigned to the routing table **1000** that is associated with the **vrf0** device.

- If you require static routes in the isolated network:

- Add the static routes:

```
# nmcli connection modify enp1s0 +ipv4.routes "198.51.100.0/24 192.0.2.2"
```

This adds a route to the **198.51.100.0/24** network that uses **192.0.2.2** as the router.

- Activate the connection:

```
# nmcli connection up enp1s0
```

## Verification

1. Display the IP settings of the device that is associated with **vrf0**:

```
# ip -br addr show vrf vrf0
enp1s0 UP 192.0.2.1/24
```

2. Display the VRF devices and their associated routing table:

```
# ip vrf show
Name          Table
-----
vrf0         1000
```

3. Display the main routing table:

```
# ip route show
default via 203.0.113.0/24 dev enp7s0 proto static metric 100
```

The main routing table does not mention any routes associated with the device **enp1s0** device or the **192.0.2.1/24** subnet.

4. Display the routing table **1000**:

```
# ip route show table 1000
default via 192.0.2.254 dev enp1s0 proto static metric 101
broadcast 192.0.2.0 dev enp1s0 proto kernel scope link src 192.0.2.1
192.0.2.0/24 dev enp1s0 proto kernel scope link src 192.0.2.1 metric 101
local 192.0.2.1 dev enp1s0 proto kernel scope host src 192.0.2.1
broadcast 192.0.2.255 dev enp1s0 proto kernel scope link src 192.0.2.1
198.51.100.0/24 via 192.0.2.2 dev enp1s0 proto static metric 101
```

The **default** entry indicates that services that use this routing table, use **192.0.2.254** as their default gateway and not the default gateway in the main routing table.

5. Execute the **traceroute** utility in the network associated with **vrf0** to verify that the utility uses the route from table **1000**:

```
# ip vrf exec vrf0 traceroute 203.0.113.1
traceroute to 203.0.113.1 (203.0.113.1), 30 hops max, 60 byte packets
 1 192.0.2.254 (192.0.2.254) 0.516 ms 0.459 ms 0.430 ms
 ...
```

The first hop is the default gateway that is assigned to the routing table **1000** and not the default gateway from the system's main routing table.

## Additional resources

- **ip-vrf(8)** man page

## 27.2. STARTING A SERVICE WITHIN AN ISOLATED VRF NETWORK

You can configure a service, such as the Apache HTTP Server, to start within an isolated virtual routing and forwarding (VRF) network.



## IMPORTANT

Services can only bind to local IP addresses that are in the same VRF network.

### Prerequisites

- You configured the **vrf0** device.
- You configured Apache HTTP Server to listen only on the IP address that is assigned to the interface associated with the **vrf0** device.

### Procedure

1. Display the content of the **httpd** systemd service:

```
# systemctl cat httpd
...
[Service]
ExecStart=/usr/sbin/httpd $OPTIONS -DFOREGROUND
...
```

You require the content of the **ExecStart** parameter in a later step to run the same command within the isolated VRF network.

2. Create the **/etc/systemd/system/httpd.service.d/** directory:

```
# mkdir /etc/systemd/system/httpd.service.d/
```

3. Create the **/etc/systemd/system/httpd.service.d/override.conf** file with the following content:

```
[Service]
ExecStart=
ExecStart=/usr/sbin/ip vrf exec vrf0 /usr/sbin/httpd $OPTIONS -DFOREGROUND
```

To override the **ExecStart** parameter, you first need to unset it and then set it to the new value as shown.

4. Reload systemd.

```
# systemctl daemon-reload
```

5. Restart the **httpd** service.

```
# systemctl restart httpd
```

### Verification

1. Display the process IDs (PID) of **httpd** processes:

```
# pidof -c httpd
1904 ...
```

2. Display the VRF association for the PIDs, for example:

```
# ip vrf identify 1904
vrf0
```

3. Display all PIDs associated with the **vrf0** device:

```
# ip vrf pids vrf0
1904 httpd
...
```

### Additional resources

- [ip-vrf\(8\)](#) man page



## CHAPTER 28. CONFIGURING ETHTOOL SETTINGS IN NETWORKMANAGER CONNECTION PROFILES

NetworkManager can configure certain network driver and hardware settings persistently. Compared to using the **ethtool** utility to manage these settings, this has the benefit of not losing the settings after a reboot.

You can set the following **ethtool** settings in NetworkManager connection profiles:

### Offload features

Network interface controllers can use the TCP offload engine (TOE) to offload processing certain operations to the network controller. This improves the network throughput.

### Interrupt coalesce settings

By using interrupt coalescing, the system collects network packets and generates a single interrupt for multiple packets. This increases the amount of data sent to the kernel with one hardware interrupt, which reduces the interrupt load, and maximizes the throughput.

### Ring buffers

These buffers store incoming and outgoing network packets. You can increase the ring buffer sizes to reduce a high packet drop rate.

## 28.1. CONFIGURING AN ETHTOOL OFFLOAD FEATURE BY USING NMCLI

You can use NetworkManager to enable and disable **ethtool** offload features in a connection profile.

### Procedure

1. For example, to enable the RX offload feature and disable TX offload in the **enp1s0** connection profile, enter:

```
# nmcli con modify enp1s0 ethtool.feature-rx on ethtool.feature-tx off
```

This command explicitly enables RX offload and disables TX offload.

2. To remove the setting of an offload feature that you previously enabled or disabled, set the feature's parameter to a null value. For example, to remove the configuration for TX offload, enter:

```
# nmcli con modify enp1s0 ethtool.feature-tx ""
```

3. Reactivate the network profile:

```
# nmcli connection up enp1s0
```

### Verification

- Use the **ethtool -k** command to display the current offload features of a network device:

```
# ethtool -k network_device
```

## Additional resources

- [nm-settings-nmcli\(5\)](#) man page

## 28.2. CONFIGURING AN ETHTOOL OFFLOAD FEATURE BY USING THE NETWORK RHEL SYSTEM ROLE

You can use the **network** RHEL system role to configure **ethtool** features of a NetworkManager connection.

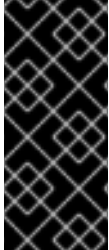

### IMPORTANT

When you run a play that uses the **network** RHEL system role and if the setting values do not match the values specified in the play, the role overrides the existing connection profile with the same name. To prevent resetting these values to their defaults, always specify the whole configuration of the network connection profile in the play, even if the configuration, for example the IP configuration, already exists.

### Prerequisites

- [You have prepared the control node and the managed nodes](#)
- You are logged in to the control node as a user who can run playbooks on the managed nodes.
- The account you use to connect to the managed nodes has **sudo** permissions on them.

### Procedure

1. Create a playbook file, for example `~/playbook.yml`, with the following content:

```
---
- name: Configure the network
  hosts: managed-node-01.example.com
  tasks:
    - name: Configure an Ethernet connection with ethtool features
      ansible.builtin.include_role:
        name: rhel-system-roles.network
      vars:
        network_connections:
          - name: enp1s0
            type: ethernet
            autoconnect: yes
            ip:
              address:
                - 198.51.100.20/24
                - 2001:db8:1::1/64
              gateway4: 198.51.100.254
              gateway6: 2001:db8:1::ffe
            dns:
              - 198.51.100.200
              - 2001:db8:1::ffbb
            dns_search:
              - example.com
        ethtool:
          features:
```

```

gro: "no"
gso: "yes"
tx_sctp_segmentation: "no"
state: up

```

This playbook creates the **enp1s0** connection profile with the following settings, or updates it if the profile already exists:

- A static **IPv4** address - **198.51.100.20** with a **/24** subnet mask
- A static **IPv6** address - **2001:db8:1::1** with a **/64** subnet mask
- An **IPv4** default gateway - **198.51.100.254**
- An **IPv6** default gateway - **2001:db8:1::fffe**
- An **IPv4** DNS server - **198.51.100.200**
- An **IPv6** DNS server - **2001:db8:1::ffbb**
- A DNS search domain - **example.com**
- **ethtool** features:
  - Generic receive offload (GRO): disabled
  - Generic segmentation offload (GSO): enabled
  - TX stream control transmission protocol (SCTP) segmentation: disabled

2. Validate the playbook syntax:

```
$ ansible-playbook --syntax-check ~/playbook.yml
```

Note that this command only validates the syntax and does not protect against a wrong but valid configuration.

3. Run the playbook:

```
$ ansible-playbook ~/playbook.yml
```

#### Additional resources

- [/usr/share/ansible/roles/rhel-system-roles.network/README.md](#) file
- [/usr/share/doc/rhel-system-roles/network/](#) directory

## 28.3. CONFIGURING AN ETHTOOL COALESCE SETTINGS BY USING NMCLI

You can use NetworkManager to set **ethtool** coalesce settings in connection profiles.

### Procedure

1. For example, to set the maximum number of received packets to delay to **128** in the **enp1s0** connection profile, enter:

```
# nmcli connection modify enp1s0 ethtool.coalesce-rx-frames 128
```

2. To remove a coalesce setting, set it to a null value. For example, to remove the **ethtool.coalesce-rx-frames** setting, enter:

```
# nmcli connection modify enp1s0 ethtool.coalesce-rx-frames ""
```

3. To reactivate the network profile:

```
# nmcli connection up enp1s0
```

## Verification

1. Use the **ethtool -c** command to display the current offload features of a network device:

```
# ethtool -c network_device
```

## Additional resources

- [nm-settings-nmcli\(5\)](#) man page

## 28.4. CONFIGURING AN ETHTOOL COALESCE SETTINGS BY USING THE NETWORK RHEL SYSTEM ROLE

You can use the **network** RHEL system role to configure **ethtool** coalesce settings of a NetworkManager connection.

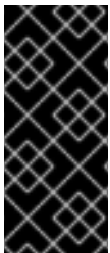

### IMPORTANT

When you run a play that uses the **network** RHEL system role and if the setting values do not match the values specified in the play, the role overrides the existing connection profile with the same name. To prevent resetting these values to their defaults, always specify the whole configuration of the network connection profile in the play, even if the configuration, for example the IP configuration, already exists.

## Prerequisites

- [You have prepared the control node and the managed nodes](#)
- You are logged in to the control node as a user who can run playbooks on the managed nodes.
- The account you use to connect to the managed nodes has **sudo** permissions on them.

## Procedure

1. Create a playbook file, for example `~/playbook.yml`, with the following content:

```
---
- name: Configure the network
```

```

hosts: managed-node-01.example.com
tasks:
  - name: Configure an Ethernet connection with ethtool coalesce settings
    ansible.builtin.include_role:
      name: rhel-system-roles.network
    vars:
      network_connections:
        - name: enp1s0
          type: ethernet
          autoconnect: yes
          ip:
            address:
              - 198.51.100.20/24
              - 2001:db8:1::1/64
            gateway4: 198.51.100.254
            gateway6: 2001:db8:1::ffe
            dns:
              - 198.51.100.200
              - 2001:db8:1::ffbb
            dns_search:
              - example.com
          ethtool:
            coalesce:
              rx_frames: 128
              tx_frames: 128
          state: up

```

This playbook creates the **enp1s0** connection profile with the following settings, or updates it if the profile already exists:

- A static IPv4 address - **198.51.100.20** with a **/24** subnet mask
- A static IPv6 address - **2001:db8:1::1** with a **/64** subnet mask
- An IPv4 default gateway - **198.51.100.254**
- An IPv6 default gateway - **2001:db8:1::ffe**
- An IPv4 DNS server - **198.51.100.200**
- An IPv6 DNS server - **2001:db8:1::ffbb**
- A DNS search domain - **example.com**
- **ethtool** coalesce settings:
  - RX frames: **128**
  - TX frames: **128**

2. Validate the playbook syntax:

```
$ ansible-playbook --syntax-check ~/playbook.yml
```

Note that this command only validates the syntax and does not protect against a wrong but valid configuration.

3. Run the playbook:

```
$ ansible-playbook ~/playbook.yml
```

### Additional resources

- `/usr/share/ansible/roles/rhel-system-roles.network/README.md` file
- `/usr/share/doc/rhel-system-roles/network/` directory

## 28.5. INCREASING THE RING BUFFER SIZE TO REDUCE A HIGH PACKET DROP RATE BY USING NMCLI

Increase the size of an Ethernet device's ring buffers if the packet drop rate causes applications to report a loss of data, timeouts, or other issues.

Receive ring buffers are shared between the device driver and network interface controller (NIC). The card assigns a transmit (TX) and receive (RX) ring buffer. As the name implies, the ring buffer is a circular buffer where an overflow overwrites existing data. There are two ways to move data from the NIC to the kernel, hardware interrupts and software interrupts, also called SoftIRQs.

The kernel uses the RX ring buffer to store incoming packets until the device driver can process them. The device driver drains the RX ring, typically by using SoftIRQs, which puts the incoming packets into a kernel data structure called an **sk\_buff** or **skb** to begin its journey through the kernel and up to the application that owns the relevant socket.

The kernel uses the TX ring buffer to hold outgoing packets which should be sent to the network. These ring buffers reside at the bottom of the stack and are a crucial point at which packet drop can occur, which in turn will adversely affect network performance.

### Procedure

1. Display the packet drop statistics of the interface:

```
# ethtool -S enp1s0
...
rx_queue_0_drops: 97326
rx_queue_1_drops: 63783
...
```

Note that the output of the command depends on the network card and the driver.

High values in **discard** or **drop** counters indicate that the available buffer fills up faster than the kernel can process the packets. Increasing the ring buffers can help to avoid such loss.

2. Display the maximum ring buffer sizes:

```
# ethtool -g enp1s0
Ring parameters for enp1s0:
Pre-set maximums:
RX:          4096
RX Mini:     0
RX Jumbo:    16320
TX:          4096
```

Current hardware settings:

```
RX:      255
RX Mini:  0
RX Jumbo: 0
TX:      255
```

If the values in the **Pre-set maximums** section are higher than in the **Current hardware settings** section, you can change the settings in the next steps.

- Identify the NetworkManager connection profile that uses the interface:

```
# nmcli connection show
NAME                UUID                                TYPE  DEVICE
Example-Connection a5eb6490-cc20-3668-81f8-0314a27f3f75 ethernet enp1s0
```

- Update the connection profile, and increase the ring buffers:

- To increase the RX ring buffer, enter:

```
# nmcli connection modify Example-Connection ethtool.ring-rx 4096
```

- To increase the TX ring buffer, enter:

```
# nmcli connection modify Example-Connection ethtool.ring-tx 4096
```

- Reload the NetworkManager connection:

```
# nmcli connection up Example-Connection
```



### IMPORTANT

Depending on the driver your NIC uses, changing in the ring buffer can shortly interrupt the network connection.

### Additional resources

- [ifconfig and ip commands report packet drops](#)
- [Should I be concerned about a 0.05% packet drop rate?](#)
- ethtool(8)** man page

## 28.6. INCREASING THE RING BUFFER SIZE TO REDUCE A HIGH PACKET DROP RATE BY USING THE NETWORK RHEL SYSTEM ROLE

Increase the size of an Ethernet device's ring buffers if the packet drop rate causes applications to report a loss of data, timeouts, or other issues.

Ring buffers are circular buffers where an overflow overwrites existing data. The network card assigns a transmit (TX) and receive (RX) ring buffer. Receive ring buffers are shared between the device driver and the network interface controller (NIC). Data can move from NIC to the kernel through either hardware interrupts or software interrupts, also called SoftIRQs.

The kernel uses the RX ring buffer to store incoming packets until the device driver can process them. The device driver drains the RX ring, typically by using SoftIRQs, which puts the incoming packets into a kernel data structure called an **sk\_buff** or **skb** to begin its journey through the kernel and up to the application that owns the relevant socket.

The kernel uses the TX ring buffer to hold outgoing packets which should be sent to the network. These ring buffers reside at the bottom of the stack and are a crucial point at which packet drop can occur, which in turn will adversely affect network performance.



## IMPORTANT

When you run a play that uses the **network** RHEL system role and if the setting values do not match the values specified in the play, the role overrides the existing connection profile with the same name. To prevent resetting these values to their defaults, always specify the whole configuration of the network connection profile in the play, even if the configuration, for example the IP configuration, already exists.

## Prerequisites

- You have prepared the control node and the managed nodes
- You are logged in to the control node as a user who can run playbooks on the managed nodes.
- The account you use to connect to the managed nodes has **sudo** permissions on them.
- You know the maximum ring buffer sizes that the device supports.

## Procedure

1. Create a playbook file, for example `~/playbook.yml`, with the following content:

```
---
- name: Configure the network
  hosts: managed-node-01.example.com
  tasks:
    - name: Configure an Ethernet connection with increased ring buffer sizes
      ansible.builtin.include_role:
        name: rhel-system-roles.network
      vars:
        network_connections:
          - name: enp1s0
            type: ethernet
            autoconnect: yes
            ip:
              address:
                - 198.51.100.20/24
                - 2001:db8:1::1/64
              gateway4: 198.51.100.254
              gateway6: 2001:db8:1::fffe
            dns:
              - 198.51.100.200
              - 2001:db8:1::ffbb
            dns_search:
              - example.com
            ethtool:
              ring:
```



```
rx: 4096
tx: 4096
state: up
```

This playbook creates the **enp1s0** connection profile with the following settings, or updates it if the profile already exists:

- A static **IPv4** address - **198.51.100.20** with a **/24** subnet mask
- A static **IPv6** address - **2001:db8:1::1** with a **/64** subnet mask
- An **IPv4** default gateway - **198.51.100.254**
- An **IPv6** default gateway - **2001:db8:1::fffe**
- An **IPv4** DNS server - **198.51.100.200**
- An **IPv6** DNS server - **2001:db8:1::ffbb**
- A DNS search domain - **example.com**
- Maximum number of ring buffer entries:
  - Receive (RX): 4096
  - Transmit (TX): 4096

2. Validate the playbook syntax:

```
$ ansible-playbook --syntax-check ~/playbook.yml
```

Note that this command only validates the syntax and does not protect against a wrong but valid configuration.

3. Run the playbook:

```
$ ansible-playbook ~/playbook.yml
```

#### Additional resources

- `/usr/share/ansible/roles/rhel-system-roles.network/README.md` file
- `/usr/share/doc/rhel-system-roles/network/` directory

## CHAPTER 29. INTRODUCTION TO NETWORKMANAGER DEBUGGING

Increasing the log levels for all or certain domains helps to log more details of the operations that NetworkManager performs. You can use this information to troubleshoot problems. NetworkManager provides different levels and domains to produce logging information. The `/etc/NetworkManager/NetworkManager.conf` file is the main configuration file for NetworkManager. The logs are stored in the journal.

### 29.1. INTRODUCTION TO NETWORKMANAGER REAPPLY METHOD

The **NetworkManager** service uses a profile to manage the connection settings of a device. Desktop Bus (D-Bus) API can create, modify, and delete these connection settings. For any changes in a profile, D-Bus API clones the existing settings to the modified settings of a connection. Despite cloning, changes do not apply to the modified settings. To make it effective, reactivate the existing settings of a connection or use the **reapply()** method.

The **reapply()** method has the following features:

1. Updating modified connection settings without deactivation or restart of a network interface.
2. Removing pending changes from the modified connection settings. As **NetworkManager** does not revert the manual changes, you can reconfigure the device and revert external or manual parameters.
3. Creating different modified connection settings than that of the existing connection settings.

Also, **reapply()** method supports the following attributes:

- **bridge.ageing-time**
- **bridge.forward-delay**
- **bridge.group-address**
- **bridge.group-forward-mask**
- **bridge.hello-time**
- **bridge.max-age**
- **bridge.multicast-hash-max**
- **bridge.multicast-last-member-count**
- **bridge.multicast-last-member-interval**
- **bridge.multicast-membership-interval**
- **bridge.multicast-querier**
- **bridge.multicast-querier-interval**
- **bridge.multicast-query-interval**
- **bridge.multicast-query-response-interval**

- **bridge.multicast-query-use-ifaddr**
- **bridge.multicast-router**
- **bridge.multicast-snooping**
- **bridge.multicast-startup-query-count**
- **bridge.multicast-startup-query-interval**
- **bridge.priority**
- **bridge.stp**
- **bridge.VLAN-filtering**
- **bridge.VLAN-protocol**
- **bridge.VLANs**
- **802-3-ethernet.accept-all-mac-addresses**
- **802-3-ethernet.cloned-mac-address**
- **IPv4.addresses**
- **IPv4.dhcp-client-id**
- **IPv4.dhcp-iaid**
- **IPv4.dhcp-timeout**
- **IPv4.DNS**
- **IPv4.DNS-priority**
- **IPv4.DNS-search**
- **IPv4.gateway**
- **IPv4.ignore-auto-DNS**
- **IPv4.ignore-auto-routes**
- **IPv4.may-fail**
- **IPv4.method**
- **IPv4.never-default**
- **IPv4.route-table**
- **IPv4.routes**
- **IPv4.routing-rules**
- **IPv6.addr-gen-mode**

- **IPv6.addresses**
- **IPv6.dhcp-duid**
- **IPv6.dhcp-iaid**
- **IPv6.dhcp-timeout**
- **IPv6.DNS**
- **IPv6.DNS-priority**
- **IPv6.DNS-search**
- **IPv6.gateway**
- **IPv6.ignore-auto-DNS**
- **IPv6.may-fail**
- **IPv6.method**
- **IPv6.never-default**
- **IPv6.ra-timeout**
- **IPv6.route-metric**
- **IPv6.route-table**
- **IPv6.routes**
- **IPv6.routing-rules**

#### Additional resources

- **nm-settings-nmcli(5)** man page

## 29.2. SETTING THE NETWORKMANAGER LOG LEVEL

By default, all the log domains are set to record the **INFO** log level. Disable rate-limiting before collecting debug logs. With rate-limiting, **systemd-journald** drops messages if there are too many of them in a short time. This can occur when the log level is **TRACE**.

This procedure disables rate-limiting and enables recording debug logs for the all (ALL) domains.

#### Procedure

1. To disable rate-limiting, edit the **/etc/systemd/journald.conf** file, uncomment the **RateLimitBurst** parameter in the **[Journal]** section, and set its value as **0**:

```
RateLimitBurst=0
```

2. Restart the **systemd-journald** service.

```
# systemctl restart systemd-journald
```

3. Create the `/etc/NetworkManager/conf.d/95-nm-debug.conf` file with the following content:

```
[logging]
domains=ALL:TRACE
```

The **domains** parameter can contain multiple comma-separated **domain:level** pairs.

4. Restart the NetworkManager service.

```
# systemctl restart NetworkManager
```

## Verification

- Query the **systemd** journal to display the journal entries of the **NetworkManager** unit:

```
# journalctl -u NetworkManager
...
Jun 30 15:24:32 server NetworkManager[164187]: <debug> [1656595472.4939] active-
connection[0x5565143c80a0]: update activation type from assume to managed
Jun 30 15:24:32 server NetworkManager[164187]: <trace> [1656595472.4939]
device[55b33c3bdb72840c] (enp1s0): sys-iface-state: assume -> managed
Jun 30 15:24:32 server NetworkManager[164187]: <trace> [1656595472.4939]
l3cfg[4281fdf43e356454,ifindex=3]: commit type register (type "update", source "device",
existing a369f23014b9ede3) -> a369f23014b9ede3
Jun 30 15:24:32 server NetworkManager[164187]: <info> [1656595472.4940] manager:
NetworkManager state is now CONNECTED_SITE
...
```

## 29.3. TEMPORARILY SETTING LOG LEVELS AT RUN TIME USING NMCLI

You can change the log level at run time using **nmcli**. However, Red Hat recommends to enable debugging using configuration files and restart NetworkManager. Updating debugging **levels** and **domains** using the **.conf** file helps to debug boot issues and captures all the logs from the initial state.

### Procedure

1. Optional: Display the current logging settings:

```
# nmcli general logging
LEVEL DOMAINS
INFO
PLATFORM,RFKILL,ETHER,WIFI,BT,MB,DHCP4,DHCP6,PPP,WIFI_SCAN,IP4,IP6,A
UTOIP4,DNS,VPN,SHARING,SUPPLICANT,AGENTS,SETTINGS,SUSPEND,CORE,DEVIC
E,OLPC,
WIMAX,INFINIBAND,FIREWALL,ADSL,BOND,VLAN,BRIDGE,DBUS_PROPS,TEAM,CONC
HECK,DC
B,DISPATCH
```

2. To modify the logging level and domains, use the following options:

- To set the log level for all domains to the same **LEVEL**, enter:

-

```
# nmcli general logging level LEVEL domains ALL
```

- To change the level for specific domains, enter:

```
# nmcli general logging level LEVEL domains DOMAINS
```

Note that updating the logging level using this command disables logging for all the other domains.

- To change the level of specific domains and preserve the level of all other domains, enter:

```
# nmcli general logging level KEEP domains DOMAIN:LEVEL,DOMAIN:LEVEL
```

## 29.4. VIEWING NETWORKMANAGER LOGS

You can view the NetworkManager logs for troubleshooting.

### Procedure

- To view the logs, enter:

```
# journalctl -u NetworkManager -b
```

### Additional resources

- [NetworkManager.conf\(5\)](#) man page
- [journalctl\(1\)](#) man page

## 29.5. DEBUGGING LEVELS AND DOMAINS

You can use the **levels** and **domains** parameters to manage the debugging for NetworkManager. The level defines the verbosity level, whereas the domains define the category of the messages to record the logs with given severity (**level**).

Log levels	Description
<b>OFF</b>	Does not log any messages about NetworkManager
<b>ERR</b>	Logs only critical errors
<b>WARN</b>	Logs warnings that can reflect the operation
<b>INFO</b>	Logs various informational messages that are useful for tracking state and operations
<b>DEBUG</b>	Enables verbose logging for debugging purposes
<b>TRACE</b>	Enables more verbose logging than the <b>DEBUG</b> level

Note that subsequent levels log all messages from earlier levels. For example, setting the log level to **INFO** also logs messages contained in the **ERR** and **WARN** log level.

#### Additional resources

- **NetworkManager.conf(5)** man page

## CHAPTER 30. USING LLDP TO DEBUG NETWORK CONFIGURATION PROBLEMS

You can use the Link Layer Discovery Protocol (LLDP) to debug network configuration problems in the topology. This means that, LLDP can report configuration inconsistencies with other hosts or routers and switches.

### 30.1. DEBUGGING AN INCORRECT VLAN CONFIGURATION USING LLDP INFORMATION

If you configured a switch port to use a certain VLAN and a host does not receive these VLAN packets, you can use the Link Layer Discovery Protocol (LLDP) to debug the problem. Perform this procedure on the host that does not receive the packets.

#### Prerequisites

- The **nmstate** package is installed.
- The switch supports LLDP.
- LLDP is enabled on neighbor devices.

#### Procedure

1. Create the `~/enable-LLDP-enp1s0.yml` file with the following content:

```
interfaces:
  - name: enp1s0
    type: ethernet
    lldp:
      enabled: true
```

2. Use the `~/enable-LLDP-enp1s0.yml` file to enable LLDP on interface **enp1s0**:

```
# nmstatectl apply ~/enable-LLDP-enp1s0.yml
```

3. Display the LLDP information:

```
# nmstatectl show enp1s0
- name: enp1s0
  type: ethernet
  state: up
  ipv4:
    enabled: false
    dhcp: false
  ipv6:
    enabled: false
    autoconf: false
    dhcp: false
  lldp:
    enabled: true
  neighbors:
    - - type: 5
```



```

system-name: Summit300-48
- type: 6
system-description: Summit300-48 - Version 7.4e.1 (Build 5)
  05/27/05 04:53:11
- type: 7
system-capabilities:
- MAC Bridge component
- Router
- type: 1
_description: MAC address
chassis-id: 00:01:30:F9:AD:A0
chassis-id-type: 4
- type: 2
_description: Interface name
port-id: 1/1
port-id-type: 5
- type: 127
ieee-802-1-vlans:
- name: v2-0488-03-0505
  vid: 488
oui: 00:80:c2
subtype: 3
- type: 127
ieee-802-3-mac-phy-conf:
  autoneg: true
  operational-mau-type: 16
  pmd-autoneg-cap: 27648
  oui: 00:12:0f
  subtype: 1
- type: 127
ieee-802-1-ppvids:
- 0
  oui: 00:80:c2
  subtype: 2
- type: 8
management-addresses:
- address: 00:01:30:F9:AD:A0
  address-subtype: MAC
  interface-number: 1001
  interface-number-subtype: 2
- type: 127
ieee-802-3-max-frame-size: 1522
  oui: 00:12:0f
  subtype: 4
mac-address: 82:75:BE:6F:8C:7A
mtu: 1500

```

4. Verify the output to ensure that the settings match your expected configuration. For example, the LLDP information of the interface connected to the switch shows that the switch port this host is connected to uses VLAN ID **448**:

```

- type: 127
ieee-802-1-vlans:
- name: v2-0488-03-0505
  vid: 488

```

If the network configuration of the **enp1s0** interface uses a different VLAN ID, change it accordingly.

### Additional resources

[Configuring VLAN tagging](#)

## CHAPTER 31. LINUX TRAFFIC CONTROL

Linux offers tools for managing and manipulating the transmission of packets. The Linux Traffic Control (TC) subsystem helps in policing, classifying, shaping, and scheduling network traffic. TC also mangles the packet content during classification by using filters and actions. The TC subsystem achieves this by using queuing disciplines (**qdisc**), a fundamental element of the TC architecture.

The scheduling mechanism arranges or rearranges the packets before they enter or exit different queues. The most common scheduler is the First-In-First-Out (FIFO) scheduler. You can do the **qdiscs** operations temporarily using the **tc** utility or permanently using NetworkManager.

In Red Hat Enterprise Linux, you can configure default queuing disciplines in various ways to manage the traffic on a network interface.

### 31.1. OVERVIEW OF QUEUING DISCIPLINES

Queuing disciplines (**qdiscs**) help with queuing up and, later, scheduling of traffic transmission by a network interface. A **qdisc** has two operations;

- enqueue requests so that a packet can be queued up for later transmission and
- dequeue requests so that one of the queued-up packets can be chosen for immediate transmission.

Every **qdisc** has a 16-bit hexadecimal identification number called a **handle**, with an attached colon, such as **1:** or **abcd:**. This number is called the **qdisc** major number. If a **qdisc** has classes, then the identifiers are formed as a pair of two numbers with the major number before the minor, **<major>:<minor>**, for example **abcd:1**. The numbering scheme for the minor numbers depends on the **qdisc** type. Sometimes the numbering is systematic, where the first-class has the ID **<major>:1**, the second one **<major>:2**, and so on. Some **qdiscs** allow the user to set class minor numbers arbitrarily when creating the class.

#### Classful **qdiscs**

Different types of **qdiscs** exist and help in the transfer of packets to and from a networking interface. You can configure **qdiscs** with root, parent, or child classes. The point where children can be attached are called classes. Classes in **qdisc** are flexible and can always contain either multiple children classes or a single child, **qdisc**. There is no prohibition against a class containing a classful **qdisc** itself, this facilitates complex traffic control scenarios.

Classful **qdiscs** do not store any packets themselves. Instead, they enqueue and dequeue requests down to one of their children according to criteria specific to the **qdisc**. Eventually, this recursive packet passing ends up where the packets are stored (or picked up from in the case of dequeuing).

#### Classless **qdiscs**

Some **qdiscs** contain no child classes and they are called classless **qdiscs**. Classless **qdiscs** require less customization compared to classful **qdiscs**. It is usually enough to attach them to an interface.

#### Additional resources

- **tc(8)** man page
- **tc-actions(8)** man page

### 31.2. INSPECTING QDISCS OF A NETWORK INTERFACE USING THE TC UTILITY

By default, Red Hat Enterprise Linux systems use **fq\_codel qdisc**. You can inspect the **qdisc** counters using the **tc** utility.

### Procedure

1. Optional: View your current **qdisc**:

```
# tc qdisc show dev enp0s1
```

2. Inspect the current **qdisc** counters:

```
# tc -s qdisc show dev enp0s1
qdisc fq_codel 0: root refcnt 2 limit 10240p flows 1024 quantum 1514 target 5.0ms interval
100.0ms memory_limit 32Mb ecn
Sent 1008193 bytes 5559 pkt (dropped 233, overlimits 55 requeues 77)
backlog 0b 0p requeues 0
```

- **dropped** - the number of times a packet is dropped because all queues are full
- **overlimits** - the number of times the configured link capacity is filled
- **sent** - the number of dequeues

## 31.3. UPDATING THE DEFAULT QDISC

If you observe networking packet losses with the current **qdisc**, you can change the **qdisc** based on your network-requirements.

### Procedure

1. View the current default **qdisc**:

```
# sysctl -a | grep qdisc
net.core.default_qdisc = fq_codel
```

2. View the **qdisc** of current Ethernet connection:

```
# tc -s qdisc show dev enp0s1
qdisc fq_codel 0: root refcnt 2 limit 10240p flows 1024 quantum 1514 target 5.0ms interval
100.0ms memory_limit 32Mb ecn
Sent 0 bytes 0 pkt (dropped 0, overlimits 0 requeues 0)
backlog 0b 0p requeues 0
maxpacket 0 drop_overlimit 0 new_flow_count 0 ecn_mark 0
new_flows_len 0 old_flows_len 0
```

3. Update the existing **qdisc**:

```
# sysctl -w net.core.default_qdisc=pfifo_fast
```

4. To apply the changes, reload the network driver:

```
# modprobe -r NETWORKDRIVERNAME
# modprobe NETWORKDRIVERNAME
```

5. Start the network interface:

```
# ip link set enp0s1 up
```

### Verification

- View the **qdisc** of the Ethernet connection:

```
# tc -s qdisc show dev enp0s1
qdisc pfifo_fast 0: root refcnt 2 bands 3 priomap  1 2 2 2 1 2 0 0 1 1 1 1 1 1 1 1
Sent 373186 bytes 5333 pkt (dropped 0, overlimits 0 requeues 0)
backlog 0b 0p requeues 0
....
```

### Additional resources

- [How to set \*\*sysctl\*\* variables on Red Hat Enterprise Linux](#)

## 31.4. TEMPORARILY SETTING THE CURRENT QDISC OF A NETWORK INTERFACE USING THE TC UTILITY

You can update the current **qdisc** without changing the default one.

### Procedure

1. Optional: View the current **qdisc**:

```
# tc -s qdisc show dev enp0s1
```

2. Update the current **qdisc**:

```
# tc qdisc replace dev enp0s1 root htb
```

### Verification

- View the updated current **qdisc**:

```
# tc -s qdisc show dev enp0s1
qdisc htb 8001: root refcnt 2 r2q 10 default 0 direct_packets_stat 0 direct_qlen 1000
Sent 0 bytes 0 pkt (dropped 0, overlimits 0 requeues 0)
backlog 0b 0p requeues 0
```

## 31.5. PERMANENTLY SETTING THE CURRENT QDISC OF A NETWORK INTERFACE USING NETWORKMANAGER

You can update the current **qdisc** value of a NetworkManager connection.

### Procedure

1. Optional: View the current **qdisc**:

```
# tc qdisc show dev enp0s1
qdisc fq_codel 0: root refcnt 2
```

2. Update the current **qdisc**:

```
# nmcli connection modify enp0s1 tc.qdiscs 'root pfifo_fast'
```

3. Optional: To add another **qdisc** over the existing **qdisc**, use the **+tc.qdisc** option:

```
# nmcli connection modify enp0s1 +tc.qdisc 'ingress handle ffff:'
```

4. Activate the changes:

```
# nmcli connection up enp0s1
```

## Verification

- View current **qdisc** the network interface:

```
# tc qdisc show dev enp0s1
qdisc pfifo_fast 8001: root refcnt 2 bands 3 priomap  1 2 2 2 1 2 0 0 1 1 1 1 1 1 1 1
qdisc ingress ffff: parent ffff:fff1 -----
```

## Additional resources

- **nm-settings(5)** man page

## 31.6. AVAILABLE QDISCS IN RHEL

Each **qdisc** addresses unique networking-related issues. The following is the list of **qdiscs** available in RHEL. You can use any of the following **qdisc** to shape network traffic based on your networking requirements.

**Table 31.1. Available schedulers in RHEL**

qdisc name	Included in	Offload support
Asynchronous Transfer Mode (ATM)	<b>kernel-modules-extra</b>	
Class-Based Queueing	<b>kernel-modules-extra</b>	
Credit-Based Shaper	<b>kernel-modules-extra</b>	Yes
CHOOSE and Keep for responsive flows, CHOOSE and Kill for unresponsive flows (CHOKe)	<b>kernel-modules-extra</b>	
Controlled Delay (CoDel)	<b>kernel-core</b>	

qdisc name	Included in	Offload support
Deficit Round Robin (DRR)	<b>kernel-modules-extra</b>	
Differentiated Services marker (DSMARK)	<b>kernel-modules-extra</b>	
Enhanced Transmission Selection (ETS)	<b>kernel-modules-extra</b>	Yes
Fair Queue (FQ)	<b>kernel-core</b>	
Fair Queuing Controlled Delay (FQ_CODEL)	<b>kernel-core</b>	
Generalized Random Early Detection (GRED)	<b>kernel-modules-extra</b>	
Hierarchical Fair Service Curve (HSFC)	<b>kernel-core</b>	
Heavy-Hitter Filter (HHF)	<b>kernel-core</b>	
Hierarchy Token Bucket (HTB)	<b>kernel-core</b>	
INGRESS	<b>kernel-core</b>	Yes
Multi Queue Priority (MQPRIO)	<b>kernel-modules-extra</b>	Yes
Multiqueue (MULTIQ)	<b>kernel-modules-extra</b>	Yes
Network Emulator (NETEM)	<b>kernel-modules-extra</b>	
Proportional Integral-controller Enhanced (PIE)	<b>kernel-core</b>	
PLUG	<b>kernel-core</b>	
Quick Fair Queueing (QFQ)	<b>kernel-modules-extra</b>	
Random Early Detection (RED)	<b>kernel-modules-extra</b>	Yes
Stochastic Fair Blue (SFB)	<b>kernel-modules-extra</b>	
Stochastic Fairness Queueing (SFQ)	<b>kernel-core</b>	
Token Bucket Filter (TBF)	<b>kernel-core</b>	Yes

qdisc name	Included in	Offload support
Trivial Link Equalizer (TEQL)	<b>kernel-modules-extra</b>	



### IMPORTANT

The **qdisc** offload requires hardware and driver support on NIC.

#### Additional resources

- **tc(8)** man page



## CHAPTER 32. AUTHENTICATING A RHEL CLIENT TO THE NETWORK BY USING THE 802.1X STANDARD WITH A CERTIFICATE STORED ON THE FILE SYSTEM

Administrators frequently use port-based Network Access Control (NAC) based on the IEEE 802.1X standard to protect a network from unauthorized LAN and Wi-Fi clients. To enable a client to connect to such networks, you must configure 802.1X authentication on this clients.

### 32.1. CONFIGURING 802.1X NETWORK AUTHENTICATION ON AN EXISTING ETHERNET CONNECTION BY USING NMCLI

You can use the **nmcli** utility to configure an Ethernet connection with 802.1X network authentication on the command line.

#### Prerequisites

- The network supports 802.1X network authentication.
- The Ethernet connection profile exists in NetworkManager and has a valid IP configuration.
- The following files required for TLS authentication exist on the client:
  - The client key stored is in the **/etc/pki/tls/private/client.key** file, and the file is owned and only readable by the **root** user.
  - The client certificate is stored in the **/etc/pki/tls/certs/client.crt** file.
  - The Certificate Authority (CA) certificate is stored in the **/etc/pki/tls/certs/ca.crt** file.
- The **wpa\_supplicant** package is installed.

#### Procedure

1. Set the Extensible Authentication Protocol (EAP) to **tls** and the paths to the client certificate and key file:

```
# nmcli connection modify enp1s0 802-1x.eap tls 802-1x.client-cert  
/etc/pki/tls/certs/client.crt 802-1x.private-key /etc/pki/tls/certs/certs/client.key
```

Note that you must set the **802-1x.eap**, **802-1x.client-cert**, and **802-1x.private-key** parameters in a single command.

2. Set the path to the CA certificate:

```
# nmcli connection modify enp1s0 802-1x.ca-cert /etc/pki/tls/certs/ca.crt
```

3. Set the identity of the user used in the certificate:

```
# nmcli connection modify enp1s0 802-1x.identity user@example.com
```

4. Optionally, store the password in the configuration:

```
# nmcli connection modify enp1s0 802-1x.private-key-password password
```



## IMPORTANT

By default, NetworkManager stores the password in clear text in the `/etc/sysconfig/network-scripts/keys-connection_name` file, that is readable only by the **root** user. However, clear text passwords in a configuration file can be a security risk.

To increase the security, set the **802-1x.password-flags** parameter to **0x1**. With this setting, on servers with the GNOME desktop environment or the **nm-applet** running, NetworkManager retrieves the password from these services. In other cases, NetworkManager prompts for the password.

5. Activate the connection profile:

```
# nmcli connection up enp1s0
```

### Verification

- Access resources on the network that require network authentication.

### Additional resources

- [Configuring an Ethernet connection](#)
- **nm-settings(5)** man page
- **nmcli(1)** man page

## 32.2. CONFIGURING A STATIC ETHERNET CONNECTION WITH 802.1X NETWORK AUTHENTICATION BY USING NMSTATECTL

Use the **nmstatectl** utility to configure an Ethernet connection with 802.1X network authentication through the Nmstate API. The Nmstate API ensures that, after setting the configuration, the result matches the configuration file. If anything fails, **nmstatectl** automatically rolls back the changes to avoid leaving the system in an incorrect state.



### NOTE

The **nmstate** library only supports the **TLS** Extensible Authentication Protocol (EAP) method.

### Prerequisites

- The network supports 802.1X network authentication.
- The managed node uses NetworkManager.
- The following files required for TLS authentication exist on the client:
  - The client key stored is in the `/etc/pki/tls/private/client.key` file, and the file is owned and only readable by the **root** user.

- The client certificate is stored in the `/etc/pki/tls/certs/client.crt` file.
- The Certificate Authority (CA) certificate is stored in the `/etc/pki/tls/certs/ca.crt` file.

## Procedure

1. Create a YAML file, for example `~/create-ethernet-profile.yml`, with the following content:

```
---
interfaces:
- name: enp1s0
  type: ethernet
  state: up
  ipv4:
    enabled: true
    address:
      - ip: 192.0.2.1
        prefix-length: 24
    dhcp: false
  ipv6:
    enabled: true
    address:
      - ip: 2001:db8:1::1
        prefix-length: 64
    autoconf: false
    dhcp: false
  802.1x:
    ca-cert: /etc/pki/tls/certs/ca.crt
    client-cert: /etc/pki/tls/certs/client.crt
    eap-methods:
      - tls
    identity: client.example.org
    private-key: /etc/pki/tls/private/client.key
    private-key-password: password
  routes:
    config:
      - destination: 0.0.0.0/0
        next-hop-address: 192.0.2.254
        next-hop-interface: enp1s0
      - destination: ::0
        next-hop-address: 2001:db8:1::fffe
        next-hop-interface: enp1s0
  dns-resolver:
    config:
      search:
        - example.com
      server:
        - 192.0.2.200
        - 2001:db8:1::ffbb
```

These settings define an Ethernet connection profile for the **enp1s0** device with the following settings:

- A static IPv4 address – **192.0.2.1** with a **/24** subnet mask
- A static IPv6 address – **2001:db8:1::1** with a **/64** subnet mask

- An IPv4 default gateway - **192.0.2.254**
  - An IPv6 default gateway - **2001:db8:1::fffe**
  - An IPv4 DNS server - **192.0.2.200**
  - An IPv6 DNS server - **2001:db8:1::ffbb**
  - A DNS search domain - **example.com**
  - 802.1X network authentication using the **TLS** EAP protocol
2. Apply the settings to the system:

```
# nmstatectl apply ~/create-ethernet-profile.yml
```

### Verification

- Access resources on the network that require network authentication.

## 32.3. CONFIGURING A STATIC ETHERNET CONNECTION WITH 802.1X NETWORK AUTHENTICATION BY USING THE NETWORK RHEL SYSTEM ROLE

You can remotely configure an Ethernet connection with 802.1X network authentication by using the **network** RHEL system role.

### Prerequisites

- [You have prepared the control node and the managed nodes](#)
- You are logged in to the control node as a user who can run playbooks on the managed nodes.
- The account you use to connect to the managed nodes has **sudo** permissions on them.
- The network supports 802.1X network authentication.
- The managed nodes uses NetworkManager.
- The following files required for TLS authentication exist on the control node:
  - The client key is stored in the **/srv/data/client.key** file.
  - The client certificate is stored in the **/srv/data/client.crt** file.
  - The Certificate Authority (CA) certificate is stored in the **/srv/data/ca.crt** file.

### Procedure

1. Create a playbook file, for example **~/playbook.yml**, with the following content:

```
---  
- name: Configure an Ethernet connection with 802.1X authentication  
  hosts: managed-node-01.example.com  
  tasks:
```

```

- name: Copy client key for 802.1X authentication
  ansible.builtin.copy:
    src: "/srv/data/client.key"
    dest: "/etc/pki/tls/private/client.key"
    mode: 0600

- name: Copy client certificate for 802.1X authentication
  ansible.builtin.copy:
    src: "/srv/data/client.crt"
    dest: "/etc/pki/tls/certs/client.crt"

- name: Copy CA certificate for 802.1X authentication
  ansible.builtin.copy:
    src: "/srv/data/ca.crt"
    dest: "/etc/pki/ca-trust/source/anchors/ca.crt"

- name: Configure connection
  ansible.builtin.include_role:
    name: rhel-system-roles.network
  vars:
    network_connections:
      - name: enp1s0
        type: ethernet
        autoconnect: yes
        ip:
          address:
            - 192.0.2.1/24
            - 2001:db8:1::1/64
          gateway4: 192.0.2.254
          gateway6: 2001:db8:1::fffe
        dns:
          - 192.0.2.200
          - 2001:db8:1::ffbb
        dns_search:
          - example.com
    ieee802_1x:
      identity: user_name
      eap: tls
      private_key: "/etc/pki/tls/private/client.key"
      private_key_password: "password"
      client_cert: "/etc/pki/tls/certs/client.crt"
      ca_cert: "/etc/pki/ca-trust/source/anchors/ca.crt"
      domain_suffix_match: example.com
    state: up

```

These settings define an Ethernet connection profile for the **enp1s0** device with the following settings:

- A static IPv4 address - **192.0.2.1** with a **/24** subnet mask
- A static IPv6 address - **2001:db8:1::1** with a **/64** subnet mask
- An IPv4 default gateway - **192.0.2.254**
- An IPv6 default gateway - **2001:db8:1::fffe**

- An IPv4 DNS server - **192.0.2.200**
- An IPv6 DNS server - **2001:db8:1::ffbb**
- A DNS search domain - **example.com**
- 802.1X network authentication using the **TLS** Extensible Authentication Protocol (EAP)

2. Validate the playbook syntax:

```
$ ansible-playbook --syntax-check ~/playbook.yml
```

Note that this command only validates the syntax and does not protect against a wrong but valid configuration.

3. Run the playbook:

```
$ ansible-playbook ~/playbook.yml
```

### Additional resources

- `/usr/share/ansible/roles/rhel-system-roles.network/README.md` file
- `/usr/share/doc/rhel-system-roles/network/` directory

## CHAPTER 33. SETTING UP AN 802.1X NETWORK AUTHENTICATION SERVICE FOR LAN CLIENTS BY USING HOSTAPD WITH FREERADIUS BACKEND

The IEEE 802.1X standard defines secure authentication and authorization methods to protect networks from unauthorized clients. By using the **hostapd** service and FreeRADIUS, you can provide network access control (NAC) in your network.

In this documentation, the RHEL host acts as a bridge to connect different clients with an existing network. However, the RHEL host grants only authenticated clients access to the network.

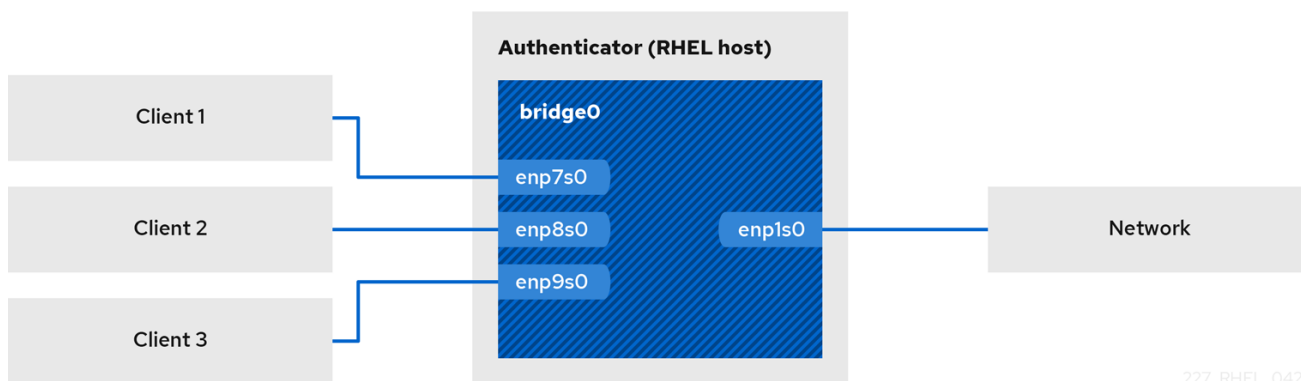

### 33.1. PREREQUISITES

- A clean installation of FreeRADIUS.  
If the **freeradius** package is already installed, remove the **/etc/raddb/** directory, uninstall and then install the package again. Do not reinstall the package by using the **yum reinstall** command, because the permissions and symbolic links in the **/etc/raddb/** directory are then different.

### 33.2. SETTING UP THE BRIDGE ON THE AUTHENTICATOR

A network bridge is a link-layer device which forwards traffic between hosts and networks based on a table of MAC addresses. If you set up RHEL as an 802.1X authenticator, add both the interfaces on which to perform authentication and the LAN interface to the bridge.

#### Prerequisites

- The server has multiple Ethernet interfaces.

#### Procedure

1. Create the bridge interface:

```
# nmcli connection add type bridge con-name br0 ifname br0
```

2. Assign the Ethernet interfaces to the bridge:

```
# nmcli connection add type ethernet slave-type bridge con-name br0-port1 ifname enp1s0 master br0
```

```
# nmcli connection add type ethernet slave-type bridge con-name br0-port2 ifname
enp7s0 master br0
# nmcli connection add type ethernet slave-type bridge con-name br0-port3 ifname
enp8s0 master br0
# nmcli connection add type ethernet slave-type bridge con-name br0-port4 ifname
enp9s0 master br0
```

3. Enable the bridge to forward extensible authentication protocol over LAN (EAPOL) packets:

```
# nmcli connection modify br0 group-forward-mask 8
```

4. Configure the connection to automatically activate the ports:

```
# nmcli connection modify br0 connection.autoconnect-slaves 1
```

5. Activate the connection:

```
# nmcli connection up br0
```

## Verification

1. Display the link status of Ethernet devices that are ports of a specific bridge:

```
# ip link show master br0
3: enp1s0: <BROADCAST,MULTICAST,UP,LOWER_UP> mtu 1500 qdisc fq_codel master
br0 state UP mode DEFAULT group default qlen 1000
    link/ether 52:54:00:62:61:0e brd ff:ff:ff:ff:ff:ff
...
```

2. Verify if forwarding of EAPOL packets is enabled on the **br0** device:

```
# cat /sys/class/net/br0/bridge/group_fwd_mask
0x8
```

If the command returns **0x8**, forwarding is enabled.

## Additional resources

- [nm-settings\(5\)](#) man page

## 33.3. CERTIFICATE REQUIREMENTS BY FREERADIUS

For a secure FreeRADIUS service, you require TLS certificates for different purposes:

- A TLS server certificate for encrypted connections to the server. Use a trusted certificate authority (CA) to issue the certificate. The server certificate requires the extended key usage (EKU) field set to **TLS Web Server Authentication**.
- Client certificates issued by the same CA for extended authentication protocol transport layer security (EAP-TLS). EAP-TLS provides certificate-based authentication and is enabled by default. The client certificates require their EKU field set to **TLS Web Client Authentication**.





### WARNING

To secure connection, use your company's CA or create your own CA to issue certificates for FreeRADIUS. If you use a public CA, you allow it to authenticate users and issue client certificates for EAP-TLS.

## 33.4. CREATING A SET OF CERTIFICATES ON A FREERADIUS SERVER FOR TESTING PURPOSES

For testing purposes, the **freeradius** package installs scripts and configuration files in the **/etc/raddb/certs/** directory to create your own certificate authority (CA) and issue certificates.



### IMPORTANT

If you use the default configuration, certificates generated by these scripts expire after 60 days and keys use an insecure password ("whatever"). However, you can customize the CA, server, and client configuration.

After you perform the procedure, the following files, which you require later in this documentation, are created:

- **/etc/raddb/certs/ca.pem**: CA certificate
- **/etc/raddb/certs/server.key**: Private key of the server certificate
- **/etc/raddb/certs/server.pem**: Server certificate
- **/etc/raddb/certs/client.key**: Private key of the client certificate
- **/etc/raddb/certs/client.pem**: Client certificate

### Prerequisites

- You installed the **freeradius** package.

### Procedure

1. Change into the **/etc/raddb/certs/** directory:

```
# cd /etc/raddb/certs/
```

2. Optional: Customize the CA configuration in the **/etc/raddb/certs/ca.cnf** file:

```
...
[ req ]
default_bits      = 2048
input_password    = ca_password
output_password   = ca_password
...
```

```
[certificate_authority]
countryName          = US
stateOrProvinceName = North Carolina
localityName         = Raleigh
organizationName     = Example Inc.
emailAddress         = admin@example.org
commonName           = "Example Certificate Authority"
...
```

- Optional: Customize the server configuration in the `/etc/raddb/certs/server.cnf` file::

```
...
[ CA_default ]
default_days        = 730
...
[ req ]
distinguished_name  = server
default_bits        = 2048
input_password      = key_password
output_password     = key_password
...
[server]
countryName         = US
stateOrProvinceName = North Carolina
localityName        = Raleigh
organizationName    = Example Inc.
emailAddress        = admin@example.org
commonName          = "Example Server Certificate"
...
```

- Optional: Customize the client configuration in the `/etc/raddb/certs/client.cnf` file::

```
...
[ CA_default ]
default_days        = 365
...
[ req ]
distinguished_name  = client
default_bits        = 2048
input_password      = password_on_private_key
output_password     = password_on_private_key
...
[client]
countryName         = US
stateOrProvinceName = North Carolina
localityName        = Raleigh
organizationName    = Example Inc.
emailAddress        = user@example.org
commonName          = user@example.org
...
```

- Create the certificates:

```
# make all
```

6. Change the group on the `/etc/raddb/certs/server.pem` file to **radiusd**:

```
# chgrp radiusd /etc/raddb/certs/server.pem
```

#### Additional resources

- `/etc/raddb/certs/README.md`

## 33.5. CONFIGURING FREERADIUS TO AUTHENTICATE NETWORK CLIENTS SECURELY BY USING EAP

FreeRADIUS supports different methods of the Extensible authentication protocol (EAP). However, for a secure network, configure FreeRADIUS to support only the following secure EAP authentication methods:

- EAP-TLS (transport layer security) uses a secure TLS connection to authenticate clients by using certificates. To use EAP-TLS, you need TLS client certificates for each network client and a server certificate for the server. Note that the same certificate authority (CA) must have issued the certificates. Always use your own CA to create certificates, because all client certificates issued by the CA you use can authenticate to your FreeRADIUS server.
- EAP-TTLS (tunneled transport layer security) uses a secure TLS connection and authenticates clients by using mechanisms, such as password authentication protocol (PAP) or challenge handshake authentication protocol (CHAP). To use EAP-TTLS, you need a TLS server certificate.
- EAP-PEAP (protected extensible authentication protocol) uses a secure TLS connection as the outer authentication protocol to set up the tunnel. The authenticator authenticates the certificate of the RADIUS server. Afterwards, the supplicant authenticates through the encrypted tunnel by using Microsoft challenge handshake authentication protocol version 2 (MS-CHAPv2) or other methods.



#### NOTE

The default FreeRADIUS configuration files serve as documentation and describe all parameters and directives. If you want to disable certain features, comment them out instead of removing the corresponding parts in the configuration files. This enables you to preserve the structure of the configuration files and the included documentation.

#### Prerequisites

- You installed the **freeradius** package.
- The configuration files in the `/etc/raddb/` directory are unchanged and as provided by the **freeradius** package.
- The following files exist on the server:
  - TLS private key of the FreeRADIUS host: `/etc/raddb/certs/server.key`
  - TLS server certificate of the FreeRADIUS host: `/etc/raddb/certs/server.pem`
  - TLS CA certificate: `/etc/raddb/certs/ca.pem`

If you store the files in a different location or if they have different names, set the **private\_key\_file**, **certificate\_file**, and **ca\_file** parameters in the **/etc/raddb/mods-available/eap** file accordingly.

## Procedure

1. If the **/etc/raddb/certs/dh** with Diffie-Hellman (DH) parameters does not exist, create one. For example, to create a DH file with a 2048 bits prime, enter:

```
# openssl dhparam -out /etc/raddb/certs/dh 2048
```

For security reasons, do not use a DH file with less than a 2048 bits prime. Depending on the number of bits, the creation of the file can take several minutes.

2. Set secure permissions on the TLS private key, server certificate, CA certificate, and the file with DH parameters:

```
# chmod 640 /etc/raddb/certs/server.key /etc/raddb/certs/server.pem
/etc/raddb/certs/ca.pem /etc/raddb/certs/dh
# chown root:radiusd /etc/raddb/certs/server.key /etc/raddb/certs/server.pem
/etc/raddb/certs/ca.pem /etc/raddb/certs/dh
```

3. Edit the **/etc/raddb/mods-available/eap** file:

- a. Set the password of the private key in the **private\_key\_password** parameter:

```
eap {
  ...
  tls-config tls-common {
    ...
    private_key_password = key_password
    ...
  }
}
```

- b. Depending on your environment, set the **default\_eap\_type** parameter in the **eap** directive to your primary EAP type you use:

```
eap {
  ...
  default_eap_type = ttls
  ...
}
```

For a secure environment, use only **ttls**, **tls**, or **peap**.

- c. Comment out the **md5** directives to disable the insecure EAP-MD5 authentication method:

```
eap {
  ...
  # md5 {
  # }
  ...
}
```

Note that, in the default configuration file, other insecure EAP authentication methods are commented out by default.

4. Edit the `/etc/raddb/sites-available/default` file, and comment out all authentication methods other than **eap**:

```
authenticate {
    ...
    # Auth-Type PAP {
    #   pap
    # }

    # Auth-Type CHAP {
    #   chap
    # }

    # Auth-Type MS-CHAP {
    #   mschap
    # }

    # mschap

    # digest
    ...
}
```

This leaves only EAP enabled and disables plain-text authentication methods.

5. Edit the `/etc/raddb/clients.conf` file:
  - a. Set a secure password in the **localhost** and **localhost\_ipv6** client directives:

```
client localhost {
    ipaddr = 127.0.0.1
    ...
    secret = client_password
    ...
}

client localhost_ipv6 {
    ipv6addr = ::1
    secret = client_password
}
```

- b. If RADIUS clients, such as network authenticators, on remote hosts should be able to access the FreeRADIUS service, add corresponding client directives for them:

```
client hostapd.example.org {
    ipaddr = 192.0.2.2/32
    secret = client_password
}
```

The **ipaddr** parameter accepts IPv4 and IPv6 addresses, and you can use the optional classless inter-domain routing (CIDR) notation to specify ranges. However, you can set only one value in this parameter. For example, to grant access to an IPv4 and IPv6 address, add two client directives.

Use a descriptive name for the client directive, such as a hostname or a word that describes where the IP range is used.

6. If you want to use EAP-TTLS or EAP-PEAP, add the users to the `/etc/raddb/users` file:

```
example_user    Cleartext-Password := "user_password"
```

For users who should use certificate-based authentication (EAP-TLS), do not add any entry.

7. Verify the configuration files:

```
# radiusd -XC
...
Configuration appears to be OK
```

8. Enable and start the **radiusd** service:

```
# systemctl enable --now radiusd
```

## Verification

- [Testing EAP-TTLS authentication against a FreeRADIUS server or authenticator](#)
- [Testing EAP-TLS authentication against a FreeRADIUS server or authenticator](#)

## Troubleshooting

1. Stop the **radiusd** service:

```
# systemctl stop radiusd
```

2. Start the service in debug mode:

```
# radiusd -X
...
Ready to process requests
```

3. Perform authentication tests on the FreeRADIUS host, as referenced in the **Verification** section.

## Next steps

- Disable no longer required authentication methods and other features you do not use.

## 33.6. CONFIGURING HOSTAPD AS AN AUTHENTICATOR IN A WIRED NETWORK

The host access point daemon (**hostapd**) service can act as an authenticator in a wired network to provide 802.1X authentication. For this, the **hostapd** service requires a RADIUS server that authenticates the clients.

The **hostapd** service provides an integrated RADIUS server. However, use the integrated RADIUS server only for testing purposes. For production environments, use FreeRADIUS server, which supports additional features, such as different authentication methods and access control.



## IMPORTANT

The **hostapd** service does not interact with the traffic plane. The service acts only as an authenticator. For example, use a script or service that uses the **hostapd** control interface to allow or deny traffic based on the result of authentication events.

## Prerequisites

- You installed the **hostapd** package.
- The FreeRADIUS server has been configured, and it is ready to authenticate clients.

## Procedure

1. Create the `/etc/hostapd/hostapd.conf` file with the following content:

```
# General settings of hostapd
# =====

# Control interface settings
ctrl_interface=/var/run/hostapd
ctrl_interface_group=wheel

# Enable logging for all modules
logger_syslog=-1
logger_stdout=-1

# Log level
logger_syslog_level=2
logger_stdout_level=2

# Wired 802.1X authentication
# =====

# Driver interface type
driver=wired

# Enable IEEE 802.1X authorization
ieee8021x=1

# Use port access entry (PAE) group address
# (01:80:c2:00:00:03) when sending EAPOL frames
use_pae_group_addr=1

# Network interface for authentication requests
interface=br0

# RADIUS client configuration
```

```
# =====  
  
# Local IP address used as NAS-IP-Address  
own_ip_addr=192.0.2.2  
  
# Unique NAS-Identifier within scope of RADIUS server  
nas_identifier=hostapd.example.org  
  
# RADIUS authentication server  
auth_server_addr=192.0.2.1  
auth_server_port=1812  
auth_server_shared_secret=client_password  
  
# RADIUS accounting server  
acct_server_addr=192.0.2.1  
acct_server_port=1813  
acct_server_shared_secret=client_password
```

For further details about the parameters used in this configuration, see their descriptions in the `/usr/share/doc/hostapd/hostapd.conf` example configuration file.

2. Enable and start the **hostapd** service:

```
# systemctl enable --now hostapd
```

## Verification

- See:
  - [Testing EAP-TTLS authentication against a FreeRADIUS server or authenticator](#)
  - [Testing EAP-TLS authentication against a FreeRADIUS server or authenticator](#)

## Troubleshooting

1. Stop the **hostapd** service:

```
# systemctl stop hostapd
```

2. Start the service in debug mode:

```
# hostapd -d /etc/hostapd/hostapd.conf
```

3. Perform authentication tests on the FreeRADIUS host, as referenced in the **Verification** section.

## Additional resources

- **hostapd.conf(5)** man page
- `/usr/share/doc/hostapd/hostapd.conf` file



## 33.7. TESTING EAP-TTLS AUTHENTICATION AGAINST A FREERADIUS SERVER OR AUTHENTICATOR

To test if authentication by using extensible authentication protocol (EAP) over tunneled transport layer security (EAP-TTLS) works as expected, run this procedure:

- After you set up the FreeRADIUS server
- After you set up the **hostapd** service as an authenticator for 802.1X network authentication.

The output of the test utilities used in this procedure provide additional information about the EAP communication and help you to debug problems.

### Prerequisites

- When you want to authenticate to:
  - A FreeRADIUS server:
    - The **eapol\_test** utility, provided by the **hostapd** package, is installed.
    - The client, on which you run this procedure, has been authorized in the FreeRADIUS server's client databases.
  - An authenticator, the **wpa\_supplicant** utility, provided by the same-named package, is installed.
- You stored the certificate authority (CA) certificate in the **/etc/pki/tls/certs/ca.pem** file.

### Procedure

1. Create the **/etc/wpa\_supplicant/wpa\_supplicant-TTLS.conf** file with the following content:

```
ap_scan=0

network={
    eap=TTLS
    eapol_flags=0
    key_mgmt=IEEE8021X

    # Anonymous identity (sent in unencrypted phase 1)
    # Can be any string
    anonymous_identity="anonymous"

    # Inner authentication (sent in TLS-encrypted phase 2)
    phase2="auth=PAP"
    identity="example_user"
    password="user_password"

    # CA certificate to validate the RADIUS server's identity
    ca_cert="/etc/pki/tls/certs/ca.pem"
}
```

2. To authenticate to:
  - A FreeRADIUS server, enter:

```
# eapol_test -c /etc/wpa_supplicant/wpa_supplicant-TTLS.conf -a 192.0.2.1 -s
client_password
...
EAP: Status notification: remote certificate verification (param=success)
...
CTRL-EVENT-EAP-SUCCESS EAP authentication completed successfully
...
SUCCESS
```

The **-a** option defines the IP address of the FreeRADIUS server, and the **-s** option specifies the password for the host on which you run the command in the FreeRADIUS server's client configuration.

- An authenticator, enter:

```
# wpa_supplicant -c /etc/wpa_supplicant/wpa_supplicant-TTLS.conf -D wired -i
enp0s31f6
...
enp0s31f6: CTRL-EVENT-EAP-SUCCESS EAP authentication completed successfully
...
```

The **-i** option specifies the network interface name on which **wpa\_supplicant** sends out extended authentication protocol over LAN (EAPOL) packets.

For more debugging information, pass the **-d** option to the command.

#### Additional resources

- `/usr/share/doc/wpa_supplicant/wpa_supplicant.conf` file

## 33.8. TESTING EAP-TLS AUTHENTICATION AGAINST A FREERADIUS SERVER OR AUTHENTICATOR

To test if authentication by using extensible authentication protocol (EAP) transport layer security (EAP-TLS) works as expected, run this procedure:

- After you set up the FreeRADIUS server
- After you set up the **hostapd** service as an authenticator for 802.1X network authentication.

The output of the test utilities used in this procedure provide additional information about the EAP communication and help you to debug problems.

#### Prerequisites

- When you want to authenticate to:
  - A FreeRADIUS server:
    - The **eapol\_test** utility, provided by the **hostapd** package, is installed.
    - The client, on which you run this procedure, has been authorized in the FreeRADIUS server's client databases.

- An authenticator, the **wpa\_supplicant** utility, provided by the same-named package, is installed.
- You stored the certificate authority (CA) certificate in the **/etc/pki/tls/certs/ca.pem** file.
- The CA that issued the client certificate is the same that issued the server certificate of the FreeRADIUS server.
- You stored the client certificate in the **/etc/pki/tls/certs/client.pem** file.
- You stored the private key of the client in the **/etc/pki/tls/private/client.key**

## Procedure

1. Create the **/etc/wpa\_supplicant/wpa\_supplicant-TLS.conf** file with the following content:

```
ap_scan=0

network={
    eap=TLS
    eapol_flags=0
    key_mgmt=IEEE8021X

    identity="user@example.org"
    client_cert="/etc/pki/tls/certs/client.pem"
    private_key="/etc/pki/tls/private/client.key"
    private_key_passwd="password_on_private_key"

    # CA certificate to validate the RADIUS server's identity
    ca_cert="/etc/pki/tls/certs/ca.pem"
}
```

2. To authenticate to:

- A FreeRADIUS server, enter:

```
# eapol_test -c /etc/wpa_supplicant/wpa_supplicant-TLS.conf -a 192.0.2.1 -s
client_password
...
EAP: Status notification: remote certificate verification (param=success)
...
CTRL-EVENT-EAP-SUCCESS EAP authentication completed successfully
...
SUCCESS
```

The **-a** option defines the IP address of the FreeRADIUS server, and the **-s** option specifies the password for the host on which you run the command in the FreeRADIUS server's client configuration.

- An authenticator, enter:

```
# wpa_supplicant -c /etc/wpa_supplicant/wpa_supplicant-TLS.conf -D wired -i
enp0s31f6
...
enp0s31f6: CTRL-EVENT-EAP-SUCCESS EAP authentication completed successfully
...
```

The **-i** option specifies the network interface name on which **wpa\_supplicant** sends out extended authentication protocol over LAN (EAPOL) packets.

For more debugging information, pass the **-d** option to the command.

#### Additional resources

- `/usr/share/doc/wpa_supplicant/wpa_supplicant.conf` file

## 33.9. BLOCKING AND ALLOWING TRAFFIC BASED ON HOSTAPD AUTHENTICATION EVENTS

The **hostapd** service does not interact with the traffic plane. The service acts only as an authenticator. However, you can write a script to allow and deny traffic based on the result of authentication events.



### IMPORTANT

This procedure is not supported and is no enterprise-ready solution. It only demonstrates how to block or allow traffic by evaluating events retrieved by **hostapd\_cli**.

When the **802-1x-tr-mgmt** systemd service starts, RHEL blocks all traffic on the listen port of **hostapd** except extensible authentication protocol over LAN (EAPOL) packets and uses the **hostapd\_cli** utility to connect to the **hostapd** control interface. The `/usr/local/bin/802-1x-tr-mgmt` script then evaluates events. Depending on the different events received by **hostapd\_cli**, the script allows or blocks traffic for MAC addresses. Note that, when the **802-1x-tr-mgmt** service stops, all traffic is automatically allowed again.

Perform this procedure on the **hostapd** server.

#### Prerequisites

- The **hostapd** service has been configured, and the service is ready to authenticate clients.

#### Procedure

1. Create the `/usr/local/bin/802-1x-tr-mgmt` file with the following content:

```
#!/bin/sh

if [ "$1" == "xblock_all" ]
then

    nft delete table bridge tr-mgmt-br0 2>/dev/null || true
    nft -f - << EOF
table bridge tr-mgmt-br0 {
    set allowed_macs {
        type ether_addr
    }

    chain accesscontrol {
        ether saddr @allowed_macs accept
        ether daddr @allowed_macs accept
        drop
    }
}
```

```

        chain forward {
            type filter hook forward priority 0; policy accept;
            meta ibrname "br0" jump accesscontrol
        }
    }
EOF
    echo "802-1x-tr-mgmt Blocking all traffic through br0. Traffic for given host will be allowed
after 802.1x authentication"

elif [ "x$1" == "xallow_all" ]
then

    nft delete table bridge tr-mgmt-br0
    echo "802-1x-tr-mgmt Allowed all forwarding again"

fi

case ${2:-NOTANEVENT} in

    AP-STA-CONNECTED | CTRL-EVENT-EAP-SUCCESS | CTRL-EVENT-EAP-
SUCCESS2)
        nft add element bridge tr-mgmt-br0 allowed_macs { $3 }
        echo "$1: Allowed traffic from $3"
        ;;

    AP-STA-DISCONNECTED | CTRL-EVENT-EAP-FAILURE)
        nft delete element bridge tr-mgmt-br0 allowed_macs { $3 }
        echo "802-1x-tr-mgmt $1: Denied traffic from $3"
        ;;

esac

```

2. Create the `/etc/systemd/system/802-1x-tr-mgmt@.service` systemd service file with the following content:

```

[Unit]
Description=Example 802.1x traffic management for hostapd
After=hostapd.service
After=sys-devices-virtual-net-%i.device

[Service]
Type=simple
ExecStartPre=-/bin/sh -c '/usr/sbin/tc qdisc del dev %i ingress > /dev/null 2>&1'
ExecStartPre=-/bin/sh -c '/usr/sbin/tc qdisc del dev %i clsact > /dev/null 2>&1'
ExecStartPre=/usr/sbin/tc qdisc add dev %i clsact
ExecStartPre=/usr/sbin/tc filter add dev %i ingress pref 10000 protocol 0x888e matchall
action ok index 100
ExecStartPre=/usr/sbin/tc filter add dev %i ingress pref 10001 protocol all matchall action
drop index 101
ExecStart=/usr/sbin/hostapd_cli -i %i -a /usr/local/bin/802-1x-tr-mgmt
ExecStopPost=-/usr/sbin/tc qdisc del dev %i clsact

[Install]
WantedBy=multi-user.target

```

3. Reload systemd:

```
# systemctl daemon-reload
```

4. Enable and start the **802-1x-tr-mgmt** service with the interface name **hostapd** is listening on:

```
# systemctl enable --now 802-1x-tr-mgmt@br0.service
```

### Verification

- Authenticate with a client to the network. See:
  - [Testing EAP-TTLS authentication against a FreeRADIUS server or authenticator](#)
  - [Testing EAP-TLS authentication against a FreeRADIUS server or authenticator](#)

### Additional resources

- **systemd.service(5)** man page

## CHAPTER 34. GETTING STARTED WITH MULTIPATH TCP

Transmission Control Protocol (TCP) ensures reliable delivery of the data through the internet and automatically adjusts its bandwidth in response to network load. Multipath TCP (MPTCP) is an extension to the original TCP protocol (single-path). MPTCP enables a transport connection to operate across multiple paths simultaneously, and brings network connection redundancy to user endpoint devices.

### 34.1. UNDERSTANDING MPTCP

The Multipath TCP (MPTCP) protocol allows for simultaneous usage of multiple paths between connection endpoints. The protocol design improves connection stability and also brings other benefits compared to the single-path TCP.



#### NOTE

In MPTCP terminology, links are considered as paths.

The following are some of the advantages of using MPTCP:

- It allows a connection to simultaneously use multiple network interfaces.
- In case a connection is bound to a link speed, the usage of multiple links can increase the connection throughput. Note, that in case of the connection is bound to a CPU, the usage of multiple links causes the connection slowdown.
- It increases the resilience to link failures.

For more details about MPTCP, we highly recommend you review the *Additional resources*.

#### Additional resources

- [Understanding Multipath TCP: High availability for endpoints and the networking highway of the future](#)
- [RFC8684: TCP Extensions for Multipath Operation with Multiple Addresses](#)
- [Multipath TCP on Red Hat Enterprise Linux 8.3: From 0 to 1 subflows](#)

### 34.2. PREPARING RHEL TO ENABLE MPTCP SUPPORT

By default the MPTCP support is disabled in RHEL. Enable MPTCP so that applications that support this feature can use it. Additionally, you have to configure user space applications to force use MPTCP sockets if those applications have TCP sockets by default.

You can use the **sysctl** utility to enable MPTCP support and prepare RHEL for enabling MPTCP for applications system-wide using a **SystemTap** script.

#### Prerequisites

The following packages are installed:

- **systemtap**
- **iperf3**

## Procedure

1. Enable MPTCP sockets in the kernel:

```
# echo "net.mptcp.enabled=1" > /etc/sysctl.d/90-enable-MPTCP.conf
# sysctl -p /etc/sysctl.d/90-enable-MPTCP.conf
```

2. Verify that MPTCP is enabled in the kernel:

```
# sysctl -a | grep mptcp.enabled
net.mptcp.enabled = 1
```

3. Create a **mptcp-app.stap** file with the following content:

```
#!/usr/bin/env stap

%{
#include <linux/in.h>
#include <linux/ip.h>
%}

/* RSI contains 'type' and RDX contains 'protocol'.
 */

function mptcpify () %{
    if (CONTEXT->kregs->si == SOCK_STREAM &&
        (CONTEXT->kregs->dx == IPPROTO_TCP ||
         CONTEXT->kregs->dx == 0)) {
        CONTEXT->kregs->dx = IPPROTO_MPTCP;
        STAP_RETVALUE = 1;
    } else {
        STAP_RETVALUE = 0;
    }
%}

probe kernel.function("__sys_socket") {
    if (mptcpify() == 1) {
        printf("command %16s mptcpified\n", execname());
    }
}
```

4. Force user space applications to create MPTCP sockets instead of TCP ones:

```
# stap -vg mptcp-app.stap
```

Note: This operation affects all TCP sockets which are started after the command. The applications will continue using TCP sockets after you interrupt the command above with **Ctrl+C**.

5. Alternatively, to allow MPTCP usage to only specific application, you can modify the **mptcp-app.stap** file with the following content:

```
#!/usr/bin/env stap

%{
```



```

#include <linux/in.h>
#include <linux/ip.h>
%}

/* according to [1], RSI contains 'type' and RDX
 * contains 'protocol'.
 * [1] https://github.com/torvalds/linux/blob/master/arch/x86/entry/entry\_64.S#L79
 */

function mptcpify () %{
if (CONTEXT->kregs->si == SOCK_STREAM &&
    (CONTEXT->kregs->dx == IPPROTO_TCP ||
    CONTEXT->kregs->dx == 0)) {
    CONTEXT->kregs->dx = IPPROTO_MPTCP;
    STAP_RETURNVALUE = 1;
} else {
    STAP_RETURNVALUE = 0;
}
%}

probe kernel.function("__sys_socket") {
    cur_proc = execname()
    if ((cur_proc == @1) && (mptcpify() == 1)) {
        printf("command %16s mptcpified\n", cur_proc);
    }
}

```

- In case of alternative choice, assuming, you want to force the **iperf3** tool to use MPTCP instead of TCP. To do so, enter the following command:

```
# stap -vg mptcp-app.stap iperf3
```

- After the **mptcp-app.stap** script installs the kernel probe, the following warnings appear in the kernel **dmesg** output

```

# dmesg
...
[ 1752.694072] Kprobes globally unoptimized
[ 1752.730147] stap_1ade3b3356f3e68765322e26dec00c3d_1476: module_layout: kernel
tainted.
[ 1752.732162] Disabling lock debugging due to kernel taint
[ 1752.733468] stap_1ade3b3356f3e68765322e26dec00c3d_1476: loading out-of-tree
module taints kernel.
[ 1752.737219] stap_1ade3b3356f3e68765322e26dec00c3d_1476: module verification
failed: signature and/or required key missing - tainting kernel
[ 1752.737219] stap_1ade3b3356f3e68765322e26dec00c3d_1476 (mptcp-app.stap):
systemtap: 4.5/0.185, base: ffffffff0550000, memory:
224data/32text/57ctx/65638net/367alloc kb, probes: 1

```

- Start the **iperf3** server:

```
# iperf3 -s
```

```
Server listening on 5201
```

9. Connect the client to the server:

```
# iperf3 -c 127.0.0.1 -t 3
```

10. After the connection is established, verify the **ss** output to see the subflow-specific status:

```
# ss -nti '( dport :5201 )'
```

```
State Recv-Q Send-Q Local Address:Port Peer Address:Port Process
ESTAB 0 0 127.0.0.1:41842 127.0.0.1:5201
cubic wscale:7,7 rto:205 rtt:4.455/8.878 ato:40 mss:21888 pmtu:65535 rcvms:536
advms:65483 cwnd:10 bytes_sent:141 bytes_acked:142 bytes_received:4 segs_out:8
segs_in:7 data_segs_out:3 data_segs_in:3 send 393050505bps lastsnd:2813 lastrcv:2772
lastack:2772 pacing_rate 785946640bps delivery_rate 10944000000bps delivered:4
busy:41ms rcv_space:43690 rcv_ssthresh:43690 minrtt:0.008 tcp-ulp-mptcp flags:Mmec
token:0000(id:0)/2ff053ec(id:0) seq:3e2cbea12d7673d4 sfseq:3 ssnoff:ad3d00f4 maplen:2
```

11. Verify MPTCP counters:

```
# nstat MPTcp*
```

```
#kernel
MPTcpExtMPCapableSYNRX      2      0.0
MPTcpExtMPCapableSYNTAX    2      0.0
MPTcpExtMPCapableSYNACKRX  2      0.0
MPTcpExtMPCapableACKRX     2      0.0
```

#### Additional resources

- [How can I download or install debuginfo packages for RHEL systems?](#)
- **tcp(7)** man page
- **mptcpize(8)** man page

### 34.3. USING IPROUTE2 TO TEMPORARILY CONFIGURE AND ENABLE MULTIPLE PATHS FOR MPTCP APPLICATIONS

Each MPTCP connection uses a single subflow similar to plain TCP. To get the MPTCP benefits, specify a higher limit for maximum number of subflows for each MPTCP connection. Then configure additional endpoints to create those subflows.

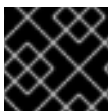

#### IMPORTANT

The configuration in this procedure will not persist after rebooting your machine.

Note that MPTCP does not yet support mixed IPv6 and IPv4 endpoints for the same socket. Use endpoints belonging to the same address family.

#### Prerequisites

- The **iperf3** package is installed

- Server network interface settings:
  - enp4s0: **192.0.2.1/24**
  - enp1s0: **198.51.100.1/24**
- Client network interface settings:
  - enp4s0f0: **192.0.2.2/24**
  - enp4s0f1: **198.51.100.2/24**

## Procedure

1. Configure the client to accept up to 1 additional remote address, as provided by the server:

```
# ip mptcp limits set add_addr_accepted 1
```

2. Add IP address **198.51.100.1** as a new MPTCP endpoint on the server:

```
# ip mptcp endpoint add 198.51.100.1 dev enp1s0 signal
```

The **signal** option ensures that the **ADD\_ADDR** packet is sent after the three-way-handshake.

3. Start the **iperf3** server:

```
# iperf3 -s
Server listening on 5201
```

4. Connect the client to the server:

```
# iperf3 -c 192.0.2.1 -t 3
```

## Verification

1. Verify the connection is established:

```
# ss -nti '( sport :5201 )'
```

2. Verify the connection and IP address limit:

```
# ip mptcp limit show
```

3. Verify the newly added endpoint:

```
# ip mptcp endpoint show
```

4. Verify MPTCP counters by using the **nstat MPTcp\*** command on a server:

```
# nstat MPTcp*
#kernel
```

MPTcpExtMPCapableSYNRX	2	0.0
MPTcpExtMPCapableACKRX	2	0.0
MPTcpExtMPJoinSynRx	2	0.0
MPTcpExtMPJoinAckRx	2	0.0
MPTcpExtEchoAdd	2	0.0

#### Additional resources

- **ip-mptcp(8)** man page
- **mptcpize(8)** man page

## 34.4. PERMANENTLY CONFIGURING MULTIPLE PATHS FOR MPTCP APPLICATIONS

You can configure MultiPath TCP (MPTCP) using the **nmcli** command to permanently establish multiple subflows between a source and destination system. The subflows can use different resources, different routes to the destination, and even different networks. Such as Ethernet, cellular, wifi, and so on. As a result, you achieve combined connections, which increase network resilience and throughput.

The server uses the following network interfaces in our example:

- enp4s0: **192.0.2.1/24**
- enp1s0: **198.51.100.1/24**
- enp7s0: **192.0.2.3/24**

The client uses the following network interfaces in our example:

- enp4s0f0: **192.0.2.2/24**
- enp4s0f1: **198.51.100.2/24**
- enp6s0: **192.0.2.5/24**

#### Prerequisites

- You configured the default gateway on the relevant interfaces.

#### Procedure

1. Enable MPTCP sockets in the kernel:

```
# echo "net.mptcp.enabled=1" > /etc/sysctl.d/90-enable-MPTCP.conf
# sysctl -p /etc/sysctl.d/90-enable-MPTCP.conf
```

2. Optional: The RHEL kernel default for subflow limit is 2. If you require more:

- a. Create the **/etc/systemd/system/set\_mptcp\_limit.service** file with the following content:

```
[Unit]
Description=Set MPTCP subflow limit to 3
After=network.target
```

```
[Service]
ExecStart=ip mptcp limits set subflows 3
Type=oneshot

[Install]
WantedBy=multi-user.target
```

The **oneshot** unit executes the **ip mptcp limits set subflows 3** command after your network (**network.target**) is operational during every boot process.

The **ip mptcp limits set subflows 3** command sets the maximum number of *additional* subflows for each connection, so 4 in total. It is possible to add maximally 3 additional subflows.

- b. Enable the **set\_mptcp\_limit** service:

```
# systemctl enable --now set_mptcp_limit
```

3. Enable MPTCP on all connection profiles that you want to use for connection aggregation:

```
# nmcli connection modify <profile_name> connection.mptcp-flags
signal,subflow,also-without-default-route
```

The **connection.mptcp-flags** parameter configures MPTCP endpoints and the IP address flags. If MPTCP is enabled in a NetworkManager connection profile, the setting will configure the IP addresses of the relevant network interface as MPTCP endpoints.

By default, NetworkManager does not add MPTCP flags to IP addresses if there is no default gateway. If you want to bypass that check, you need to use also the **also-without-default-route** flag.

## Verification

1. Verify that you enabled the MPTCP kernel parameter:

```
# sysctl net.mptcp.enabled
net.mptcp.enabled = 1
```

2. Verify that you set the subflow limit correctly, in case the default was not enough:

```
# ip mptcp limit show
add_addr_accepted 2 subflows 3
```

3. Verify that you configured the per-address MPTCP setting correctly:

```
# ip mptcp endpoint show
192.0.2.1 id 1 subflow dev enp4s0
198.51.100.1 id 2 subflow dev enp1s0
192.0.2.3 id 3 subflow dev enp7s0
192.0.2.4 id 4 subflow dev enp3s0
...
```

## Additional resources

- [nm-settings-nmcli\(5\)](#)
- [ip-mptcp\(8\)](#)
- [Section 34.1, “Understanding MPTCP”](#)
- [Understanding Multipath TCP: High availability for endpoints and the networking highway of the future](#)
- [RFC8684: TCP Extensions for Multipath Operation with Multiple Addresses](#)
- [Using Multipath TCP to better survive outages and increase bandwidth](#)

## 34.5. MONITORING MPTCP SUB-FLOWS

The life cycle of a multipath TCP (MPTCP) socket can be complex: The main MPTCP socket is created, the MPTCP path is validated, one or more sub-flows are created and eventually removed. Finally, the MPTCP socket is terminated.

The MPTCP protocol allows monitoring MPTCP-specific events related to socket and sub-flow creation and deletion, using the **ip** utility provided by the **iproute** package. This utility uses the **netlink** interface to monitor MPTCP events.

This procedure demonstrates how to monitor MPTCP events. For that, it simulates a MPTCP server application, and a client connects to this service. The involved clients in this example use the following interfaces and IP addresses:

- Server: **192.0.2.1**
- Client (Ethernet connection): **192.0.2.2**
- Client (WiFi connection): **192.0.2.3**

To simplify this example, all interfaces are within the same subnet. This is not a requirement. However, it is important that routing has been configured correctly, and the client can reach the server via both interfaces.

### Prerequisites

- A RHEL client with two network interfaces, such as a laptop with Ethernet and WiFi
- The client can connect to the server via both interfaces
- A RHEL server
- Both the client and the server run RHEL 8.6 or later

### Procedure

1. Set the per connection additional subflow limits to **1** on both client and server:

```
# ip mptcp limits set add_addr_accepted 0 subflows 1
```

2. On the server, to simulate a MPTCP server application, start **netcat (nc)** in listen mode with enforced MPTCP sockets instead of TCP sockets:

```
# nc -l -k -p 12345
```

The **-k** option causes that **nc** does not close the listener after the first accepted connection. This is required to demonstrate the monitoring of sub-flows.

3. On the client:

a. Identify the interface with the lowest metric:

```
# ip -4 route
192.0.2.0/24 dev enp1s0 proto kernel scope link src 192.0.2.2 metric 100
192.0.2.0/24 dev wlp1s0 proto kernel scope link src 192.0.2.3 metric 600
```

The **enp1s0** interface has a lower metric than **wlp1s0**. Therefore, RHEL uses **enp1s0** by default.

b. On the first terminal, start the monitoring:

```
# ip mptcp monitor
```

c. On the second terminal, start a MPTCP connection to the server:

```
# nc 192.0.2.1 12345
```

RHEL uses the **enp1s0** interface and its associated IP address as a source for this connection.

On the monitoring terminal, the **ip mptcp monitor** command now logs:

```
[ CREATED] token=63c070d2 remid=0 locid=0 saddr4=192.0.2.2 daddr4=192.0.2.1
sport=36444 dport=12345
```

The token identifies the MPTCP socket as a unique ID, and later it enables you to correlate MPTCP events on the same socket.

d. On the terminal with the running **nc** connection to the server, press **Enter**. This first data packet fully establishes the connection. Note that, as long as no data has been sent, the connection is not established.

On the monitoring terminal, **ip mptcp monitor** now logs:

```
[ ESTABLISHED] token=63c070d2 remid=0 locid=0 saddr4=192.0.2.2
daddr4=192.0.2.1 sport=36444 dport=12345
```

e. Optional: Display the connections to port **12345** on the server:

```
# ss -taunp | grep ":12345"
tcp ESTAB 0 0      192.0.2.2:36444 192.0.2.1:12345
```

At this point, only one connection to the server has been established.

f. On a third terminal, create another endpoint:

```
# ip mptcp endpoint add dev wlp1s0 192.0.2.3 subflow
```

This command sets the name and IP address of the WiFi interface of the client in this command.

On the monitoring terminal, **ip mptcp monitor** now logs:

```
[SF_ESTABLISHED] token=63c070d2 remid=0 locid=2 saddr4=192.0.2.3
daddr4=192.0.2.1 sport=53345 dport=12345 backup=0 ifindex=3
```

The **locid** field displays the local address ID of the new sub-flow and identifies this sub-flow even if the connection uses network address translation (NAT). The **saddr4** field matches the endpoint's IP address from the **ip mptcp endpoint add** command.

g. Optional: Display the connections to port **12345** on the server:

```
# ss -taunp | grep ":12345"
tcp ESTAB 0 0      192.0.2.2:36444 192.0.2.1:12345
tcp ESTAB 0 0 192.0.2.3%wlp1s0:53345 192.0.2.1:12345
```

The command now displays two connections:

- The connection with source address **192.0.2.2** corresponds to the first MPTCP sub-flow that you established previously.
- The connection from the sub-flow over the **wlp1s0** interface with source address **192.0.2.3**.

h. On the third terminal, delete the endpoint:

```
# ip mptcp endpoint delete id 2
```

Use the ID from the **locid** field from the **ip mptcp monitor** output, or retrieve the endpoint ID using the **ip mptcp endpoint show** command.

On the monitoring terminal, **ip mptcp monitor** now logs:

```
[ SF_CLOSED] token=63c070d2 remid=0 locid=2 saddr4=192.0.2.3 daddr4=192.0.2.1
sport=53345 dport=12345 backup=0 ifindex=3
```

i. On the first terminal with the **nc** client, press **Ctrl+C** to terminate the session.

On the monitoring terminal, **ip mptcp monitor** now logs:

```
[ CLOSED] token=63c070d2
```

#### Additional resources

- **ip-mptcp(1)** man page
- [How NetworkManager manages multiple default gateways](#)

## 34.6. DISABLING MULTIPATH TCP IN THE KERNEL

You can explicitly disable the MPTCP option in the kernel.



## Procedure

- Disable the **mptcp.enabled** option.

```
# echo "net.mptcp.enabled=0" > /etc/sysctl.d/90-enable-MPTCP.conf  
# sysctl -p /etc/sysctl.d/90-enable-MPTCP.conf
```

## Verification

- Verify whether the **mptcp.enabled** is disabled in the kernel.

```
# sysctl -a | grep mptcp.enabled  
net.mptcp.enabled = 0
```

## CHAPTER 35. LEGACY NETWORK SCRIPTS SUPPORT IN RHEL

By default, RHEL uses NetworkManager to configure and manage network connections, and the `/usr/sbin/ifup` and `/usr/sbin/ifdown` scripts use NetworkManager to process `ifcfg` files in the `/etc/sysconfig/network-scripts/` directory.



### IMPORTANT

The legacy scripts are deprecated in RHEL 8 and will be removed in a future major version of RHEL. If you still use the legacy network scripts, for example, because you upgraded from an earlier version to RHEL 8, Red Hat recommends that you migrate your configuration to NetworkManager.

### 35.1. INSTALLING THE LEGACY NETWORK SCRIPTS

If you require the deprecated network scripts that processes the network configuration without using NetworkManager, you can install them. In this case, the `/usr/sbin/ifup` and `/usr/sbin/ifdown` scripts link to the deprecated shell scripts that manage the network configuration.

#### Procedure

- Install the `network-scripts` package:

```
# yum install network-scripts
```

## CHAPTER 36. CONFIGURING IP NETWORKING WITH IFCFG FILES

Interface configuration (**ifcfg**) files control the software interfaces for individual network devices. As the system boots, it uses these files to determine what interfaces to bring up and how to configure them. These files are named **ifcfg-name\_pass**, where the suffix *name* refers to the name of the device that the configuration file controls. By convention, the **ifcfg** file's suffix is the same as the string given by the **DEVICE** directive in the configuration file itself.



### IMPORTANT

NetworkManager supports profiles stored in the keyfile format. However, by default, NetworkManager uses the **ifcfg** format when you use the NetworkManager API to create or update profiles.

In a future major RHEL release, the keyfile format will be default. Consider using the keyfile format if you want to manually create and manage configuration files. For details, see [NetworkManager connection profiles in keyfile format](#).

### 36.1. CONFIGURING AN INTERFACE WITH STATIC NETWORK SETTINGS USING IFCFG FILES

If you do not use the NetworkManager utilities and applications, you can manually configure a network interface by creating **ifcfg** files.

#### Procedure

- To configure an interface with static network settings using **ifcfg** files, for an interface with the name **enp1s0**, create a file with the name **ifcfg-enp1s0** in the **/etc/sysconfig/network-scripts/** directory that contains:

- For **IPv4** configuration:

```
DEVICE=enp1s0
BOOTPROTO=none
ONBOOT=yes
PREFIX=24
IPADDR=192.0.2.1
GATEWAY=192.0.2.254
```

- For **IPv6** configuration:

```
DEVICE=enp1s0
BOOTPROTO=none
ONBOOT=yes
IPV6INIT=yes
IPV6ADDR=2001:db8:1::2/64
```

#### Additional resources

- **nm-settings-ifcfg-rh(5)** man page

## 36.2. CONFIGURING AN INTERFACE WITH DYNAMIC NETWORK SETTINGS USING IFCFG FILES

If you do not use the NetworkManager utilities and applications, you can manually configure a network interface by creating **ifcfg** files.

### Procedure

1. To configure an interface named *em1* with dynamic network settings using **ifcfg** files, create a file with the name **ifcfg-em1** in the **/etc/sysconfig/network-scripts/** directory that contains:

```
DEVICE=em1
BOOTPROTO=dhcp
ONBOOT=yes
```

2. To configure an interface to send:

- A different host name to the **DHCP** server, add the following line to the **ifcfg** file:

```
DHCP_HOSTNAME=hostname
```

- A different fully qualified domain name (FQDN) to the **DHCP** server, add the following line to the **ifcfg** file:

```
DHCP_FQDN=fully.qualified.domain.name
```



### NOTE

You can use only one of these settings. If you specify both **DHCP\_HOSTNAME** and **DHCP\_FQDN**, only **DHCP\_FQDN** is used.

3. To configure an interface to use particular **DNS** servers, add the following lines to the **ifcfg** file:

```
PEERDNS=no
DNS1=ip-address
DNS2=ip-address
```

where *ip-address* is the address of a **DNS** server. This will cause the network service to update **/etc/resolv.conf** with the specified **DNS** servers specified. Only one **DNS** server address is necessary, the other is optional.

## 36.3. MANAGING SYSTEM-WIDE AND PRIVATE CONNECTION PROFILES WITH IFCFG FILES

By default, all users on a host can use the connections defined in **ifcfg** files. You can limit this behavior to specific users by adding the **USERS** parameter to the **ifcfg** file.

### Prerequisite

- The **ifcfg** file already exists.

### Procedure

1. Edit the **ifcfg** file in the **/etc/sysconfig/network-scripts/** directory that you want to limit to certain users, and add:

```
USERS="username1 username2 ..."
```

2. Reactive the connection:

```
# nmcli connection up connection_name
```

## CHAPTER 37. NETWORKMANAGER CONNECTION PROFILES IN KEYFILE FORMAT

By default, NetworkManager stores connection profiles in **ifcfg** format, but you can also use profiles in keyfile format. Unlike the deprecated **ifcfg** format, the keyfile format supports all connection settings that NetworkManager provides.

In the Red Hat Enterprise Linux 9, the keyfile format will be the default.

### 37.1. THE KEYFILE FORMAT OF NETWORKMANAGER PROFILES

The keyfile format is similar to the INI format. For example, the following is an Ethernet connection profile in keyfile format:

```
[connection]
id=example_connection
uuid=82c6272d-1ff7-4d56-9c7c-0eb27c300029
type=ethernet
autoconnect=true

[ipv4]
method=auto

[ipv6]
method=auto

[ethernet]
mac-address=00:53:00:8f:fa:66
```

Each section corresponds to a NetworkManager setting name as described in the **nm-settings(5)** and **nm-settings-keyfile(5)** man pages. Each key-value-pair in a section is one of the properties listed in the settings specification of the man page.

Most variables in NetworkManager keyfiles have a one-to-one mapping. This means that a NetworkManager property is stored in the keyfile as a variable of the same name and in the same format. However, there are exceptions, mainly to make the keyfile syntax easier to read. For a list of these exceptions, see the **nm-settings-keyfile(5)** man page.

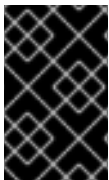

#### IMPORTANT

For security reasons, because connection profiles can contain sensitive information, such as private keys and passphrases, NetworkManager uses only configuration files owned by the **root** user and that are only readable and writable by **root**.

Depending on the purpose of the connection profile, save it in one of the following directories:

- **/etc/NetworkManager/system-connections/**: The location of persistent profiles. If you modify a persistent profile by using the NetworkManager API, NetworkManager writes and overwrites files in this directory.
- **/run/NetworkManager/system-connections/**: For temporary profiles that are automatically removed when you reboot the system.

- **/usr/lib/NetworkManager/system-connections/**: For pre-deployed immutable profiles. When you edit such a profile using the NetworkManager API, NetworkManager copies this profile to either the persistent or temporary storage.

NetworkManager does not automatically reload profiles from disk. When you create or update a connection profile in keyfile format, use the **nmcli connection reload** command to inform NetworkManager about the changes.

## 37.2. USING NMCLI TO CREATE KEYFILE CONNECTION PROFILES IN OFFLINE MODE

Red Hat recommends using NetworkManager utilities, such as **nmcli**, the **network** RHEL system role, or the **nmstate** API to manage NetworkManager connections, to create and update configuration files. However, you can also create various connection profiles in the keyfile format in offline mode using the **nmcli --offline connection add** command.

The offline mode ensures that **nmcli** operates without the **NetworkManager** service to produce keyfile connection profiles through standard output. This feature can be useful if:

- You want to create your connection profiles that need to be pre-deployed somewhere. For example in a container image, or as an RPM package.
- You want to create your connection profiles in an environment where the **NetworkManager** service is not available. For example when you want to use the **chroot** utility. Alternatively, when you want to create or modify the network configuration of the RHEL system to be installed through the Kickstart **%post** script.

You can create the following connection profile types:

- static Ethernet connection
- dynamic Ethernet connection
- network bond
- network bridge
- VLAN or any kind of supported connections

### Procedure

1. Create a new connection profile in the keyfile format. For example, for a connection profile of an Ethernet device that does not use DHCP, run a similar **nmcli** command:

```
# nmcli --offline connection add type ethernet con-name Example-Connection
  ipv4.addresses 192.0.2.1/24 ipv4.dns 192.0.2.200 ipv4.method manual >
  /etc/NetworkManager/system-connections/output.nmconnection
```

**NOTE**

The connection name you specified with the **con-name** key is saved into the **id** variable of the generated profile. When you use the **nmcli** command to manage this connection later, specify the connection as follows:

- When the **id** variable is not omitted, use the connection name, for example **Example-Connection**.
- When the **id** variable is omitted, use the file name without the **.nmconnection** suffix, for example **output**.

2. Set permissions to the configuration file so that only the **root** user can read and update it:

```
# chmod 600 /etc/NetworkManager/system-connections/output.nmconnection
# chown root:root /etc/NetworkManager/system-connections/output.nmconnection
```

3. Start the **NetworkManager** service:

```
# systemctl start NetworkManager.service
```

4. If you set the **autoconnect** variable in the profile to **false**, activate the connection:

```
# nmcli connection up Example-Connection
```

**Verification**

1. Verify that the **NetworkManager** service is running:

```
# systemctl status NetworkManager.service
• NetworkManager.service - Network Manager
  Loaded: loaded (/usr/lib/systemd/system/NetworkManager.service; enabled; vendor preset:
  enabled)
  Active: active (running) since Wed 2022-08-03 13:08:32 CEST; 1min 40s ago
  ...
```

2. Verify that NetworkManager can read the profile from the configuration file:

```
# nmcli -f TYPE,FILENAME,NAME connection
TYPE  FILENAME                                     NAME
ethernet /etc/NetworkManager/system-connections/output.nmconnection Example-
Connection
ethernet /etc/sysconfig/network-scripts/ifcfg-enp1s0      enp1s0
...
```

If the output does not show the newly created connection, verify that the keyfile permissions and the syntax you used are correct.

3. Display the connection profile:

```
# nmcli connection show Example-Connection
connection.id:          Example-Connection
connection.uuid:        232290ce-5225-422a-9228-cb83b22056b4
connection.stable-id:   --
```



```

connection.type:          802-3-ethernet
connection.interface-name: --
connection.autoconnect:  yes
...

```

### Additional resources

- [nmcli\(1\)](#)
- [nm-settings-keyfile\(5\)](#)
- [The keyfile format of NetworkManager profiles](#)
- [Configuring an Ethernet connection by using nmcli](#)
- [Configuring VLAN tagging by using nmcli](#)
- [Configuring a network bridge by using nmcli](#)
- [Configuring a network bond by using nmcli](#)

## 37.3. MANUALLY CREATING A NETWORKMANAGER PROFILE IN KEYFILE FORMAT

You can manually create a NetworkManager connection profile in keyfile format.



### NOTE

Manually creating or updating the configuration files can result in an unexpected or non-functional network configuration. As an alternative, you can use **nmcli** in offline mode. See [Using nmcli to create keyfile connection profiles in offline mode](#)

### Procedure

1. If you create a profile for a hardware interface, such as Ethernet, display the MAC address of this interface:

```

# ip address show enp1s0
2: enp1s0: <BROADCAST,MULTICAST,UP,LOWER_UP> mtu 1500 qdisc fq_codel state UP
group default qlen 1000
link/ether 00:53:00:8f:fa:66 brd ff:ff:ff:ff:ff:ff

```

2. Create a connection profile. For example, for a connection profile of an Ethernet device that uses DHCP, create the `/etc/NetworkManager/system-connections/example.nmconnection` file with the following content:

```

[connection]
id=example_connection
type=ethernet
autoconnect=true

[ipv4]
method=auto

```

```
[ipv6]
method=auto

[ethernet]
mac-address=00:53:00:8f:fa:66
```



## NOTE

You can use any file name with a **.nmconnection** suffix. However, when you later use **nmcli** commands to manage the connection, you must use the connection name set in the **id** variable when you refer to this connection. When you omit the **id** variable, use the file name without the **.nmconnection** to refer to this connection.

- Set permissions on the configuration file so that only the **root** user can read and update it:

```
# chown root:root /etc/NetworkManager/system-connections/example.nmconnection
# chmod 600 /etc/NetworkManager/system-connections/example.nmconnection
```

- Reload the connection profiles:

```
# nmcli connection reload
```

- Verify that NetworkManager read the profile from the configuration file:

```
# nmcli -f NAME,UUID,FILENAME connection
NAME          UUID          FILENAME
example-connection 86da2486-068d-4d05-9ac7-957ec118afba
/etc/NetworkManager/system-connections/example.nmconnection
...
```

If the command does not show the newly added connection, verify that the file permissions and the syntax you used in the file are correct.

- If you set the **autoconnect** variable in the profile to **false**, activate the connection:

```
# nmcli connection up example_connection
```

## Verification

- Display the connection profile:

```
# nmcli connection show example_connection
```

## Additional resources

- [nm-settings-keyfile \(5\)](#)

## 37.4. THE DIFFERENCES IN INTERFACE RENAMING WITH PROFILES IN IFCFG AND KEYFILE FORMAT

You can define custom network interface names, such as **provider** or **lan** to make interface names more descriptive. In this case, the **udev** service renames the interfaces. The renaming process works differently depending on whether you use connection profiles in **ifcfg** or keyfile format.

### The interface renaming process when using a profile in ifcfg format

1. The `/usr/lib/udev/rules.d/60-net.rules udev` rule calls the `/lib/udev/rename_device` helper utility.
2. The helper utility searches for the **HWADDR** parameter in `/etc/sysconfig/network-scripts/ifcfg-*` files.
3. If the value set in the variable matches the MAC address of an interface, the helper utility renames the interface to the name set in the **DEVICE** parameter of the file.

### The interface renaming process when using a profile in keyfile format

1. Create a [systemd link file](#) or a [udev rule](#) to rename an interface.
2. Use the custom interface name in the **interface-name** property of a NetworkManager connection profile.

### Additional resources

- [How the udev device manager renames network interfaces](#)
- [Configuring user-defined network interface names by using udev rules](#)
- [Configuring user-defined network interface names by using systemd link files](#)

## 37.5. MIGRATING NETWORKMANAGER PROFILES FROM IFCFG TO KEYFILE FORMAT

If you use connection profiles in **ifcfg** format, you can convert them to the keyfile format to have all profiles in the preferred format and in one location.



### NOTE

If an **ifcfg** file contains the **NM\_CONTROLLED=no** setting, NetworkManager does not control this profile and, consequently the migration process ignores it.

### Prerequisites

- You have connection profiles in **ifcfg** format in the `/etc/sysconfig/network-scripts/` directory.
- If the connection profiles contain a **DEVICE** variable that is set to a custom device name, such as **provider** or **lan**, you created a [systemd link file](#) or a [udev rule](#) for each of the custom device names.

### Procedure

- Migrate the connection profiles:

```
# nmcli connection migrate
```

```
Connection 'enp1s0' (43ed18ab-f0c4-4934-af3d-2b3333948e45) successfully migrated.  
Connection 'enp2s0' (883333e8-1b87-4947-8ceb-1f8812a80a9b) successfully migrated.  
...
```

## Verification

- Optionally, you can verify that you successfully migrated all your connection profiles:

```
# nmcli -f TYPE,FILENAME,NAME connection  
TYPE  FILENAME                                     NAME  
ethernet /etc/NetworkManager/system-connections/enp1s0.nmconnection  enp1s0  
ethernet /etc/NetworkManager/system-connections/enp2s0.nmconnection  enp2s0  
...
```

## Additional resources

- [nm-settings-keyfile\(5\)](#)
- [nm-settings-ifcfg-rh\(5\)](#)
- [How the udev device manager renames network interfaces](#)

## CHAPTER 38. SYSTEMD NETWORK TARGETS AND SERVICES

NetworkManager configures the network during the system boot process. However, when booting with a remote root (/), such as if the root directory is stored on an iSCSI device, the network settings are applied in the initial RAM disk (**initrd**) before RHEL is started. For example, if the network configuration is specified on the kernel command line using **rd.neednet=1** or a configuration is specified to mount remote file systems, then the network settings are applied on **initrd**.

RHEL uses the **network** and **network-online** targets and the **NetworkManager-wait-online** service while applying network settings. Also, you can configure **systemd** services to start after the network is fully available if these services cannot dynamically reload.

### 38.1. DIFFERENCES BETWEEN THE NETWORK AND NETWORK-ONLINE SYSTEMD TARGET

Systemd maintains the **network** and **network-online** target units. The special units such as **NetworkManager-wait-online.service**, have **WantedBy=network-online.target** and **Before=network-online.target** parameters. If enabled, these units get started with **network-online.target** and delay the target to be reached until some form of network connectivity is established. They delay the **network-online** target until the network is connected.

The **network-online** target starts a service, which adds substantial delays to further execution. Systemd automatically adds dependencies with **Wants** and **After** parameters for this target unit to all the System V (SysV) **init** script service units with a Linux Standard Base (LSB) header referring to the **\$network** facility. The LSB header is metadata for **init** scripts. You can use it to specify dependencies. This is similar to the **systemd** target.

The **network** target does not significantly delay the execution of the boot process. Reaching the **network** target means that the service that is responsible for setting up the network has started. However, it does not mean that a network device was configured. This target is important during the shutdown of the system. For example, if you have a service that was ordered after the **network** target during bootup, then this dependency is reversed during the shutdown. The network does not get disconnected until your service has been stopped. All mount units for remote network file systems automatically start the **network-online** target unit and order themselves after it.

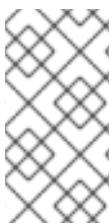

#### NOTE

The **network-online** target unit is only useful during the system starts. After the system has completed booting up, this target does not track the online state of the network. Therefore, you cannot use **network-online** to monitor the network connection. This target provides a one-time system startup concept.

### 38.2. OVERVIEW OF NETWORKMANAGER-WAIT-ONLINE

The synchronous legacy network scripts iterate through all configuration files to set up devices. They apply all network-related configurations and ensure that the network is online.

The **NetworkManager-wait-online** service waits with a timeout for the network to be configured. This network configuration involves plugging-in an Ethernet device, scanning for a Wi-Fi device, and so forth. NetworkManager automatically activates suitable profiles that are configured to start automatically. The failure of the automatic activation process due to a DHCP timeout or similar event might keep NetworkManager busy for an extended period of time. Depending on the configuration, NetworkManager retries activating the same profile or a different profile.

When the startup completes, either all profiles are in a disconnected state or are successfully activated. You can configure profiles to auto-connect. The following are a few examples of parameters that set timeouts or define when the connection is considered active:

- **connection.wait-device-timeout** - sets the timeout for the driver to detect the device
- **ipv4.may-fail** and **ipv6.may-fail** - sets activation with one IP address family ready, or whether a particular address family must have completed configuration.
- **ipv4.gateway-ping-timeout** - delays activation.

#### Additional resources

- **nm-settings(5)** man page

## 38.3. CONFIGURING A SYSTEMD SERVICE TO START AFTER THE NETWORK HAS BEEN STARTED

Red Hat Enterprise Linux installs **systemd** service files in the `/usr/lib/systemd/system/` directory. This procedure creates a drop-in snippet for a service file in `/etc/systemd/system/service_name.service.d/` that is used together with the service file in `/usr/lib/systemd/system/` to start a particular *service* after the network is online. It has a higher priority if settings in the drop-in snippet overlap with the ones in the service file in `/usr/lib/systemd/system/`.

#### Procedure

1. To open the service file in the editor, enter:

```
# systemctl edit service_name
```

2. Enter the following, and save the changes:

```
[Unit]
After=network-online.target
```

3. Reload the **systemd** service.

```
# systemctl daemon-reload
```

## CHAPTER 39. INTRODUCTION TO NMSTATE

Nmstate is a declarative network manager API. The **nmstate** package provides the **libnmstate** Python library and a command-line utility, **nmstatectl**, to manage NetworkManager on RHEL. When you use Nmstate, you describe the expected networking state using YAML or JSON-formatted instructions.

Nmstate has many benefits. For example, it:

- Provides a stable and extensible interface to manage RHEL network capabilities
- Supports atomic and transactional operations at the host and cluster level
- Supports partial editing of most properties and preserves existing settings that are not specified in the instructions
- Provides plug-in support to enable administrators to use their own plug-ins

### 39.1. USING THE LIBNMSTATE LIBRARY IN A PYTHON APPLICATION

The **libnmstate** Python library enables developers to use Nmstate in their own application

To use the library, import it in your source code:

```
import libnmstate
```

Note that you must install the **nmstate** package to use this library.

#### Example 39.1. Querying the network state using the libnmstate library

The following Python code imports the **libnmstate** library and displays the available network interfaces and their state:

```
import json
import libnmstate
from libnmstate.schema import Interface

net_state = libnmstate.show()
for iface_state in net_state[Interface.KEY]:
    print(iface_state[Interface.NAME] + ": "
          + iface_state[Interface.STATE])
```

### 39.2. UPDATING THE CURRENT NETWORK CONFIGURATION USING NMSTATECTL

You can use the **nmstatectl** utility to store the current network configuration of one or all interfaces in a file. You can then use this file to:

- Modify the configuration and apply it to the same system.
- Copy the file to a different host and configure the host with the same or modified settings.

For example, you can export the settings of the **enp1s0** interface to a file, modify the configuration, and apply the settings to the host.

### Prerequisites

- The **nmstate** package is installed.

### Procedure

1. Export the settings of the **enp1s0** interface to the `~/network-config.yml` file:

```
# nmstatectl show enp1s0 > ~/network-config.yml
```

This command stores the configuration of **enp1s0** in YAML format. To store the output in JSON format, pass the **--json** option to the command.

If you do not specify an interface name, **nmstatectl** exports the configuration of all interfaces.

2. Modify the `~/network-config.yml` file using a text editor to update the configuration.
3. Apply the settings from the `~/network-config.yml` file:

```
# nmstatectl apply ~/network-config.yml
```

If you exported the settings in JSON format, pass the **--json** option to the command.

## 39.3. NETWORK STATES FOR THE NETWORK RHEL SYSTEM ROLE

The **network** RHEL system role supports state configurations in playbooks to configure the devices. For this, use the **network\_state** variable followed by the state configurations.

Benefits of using the **network\_state** variable in a playbook:

- Using the declarative method with the state configurations, you can configure interfaces, and the NetworkManager creates a profile for these interfaces in the background.
- With the **network\_state** variable, you can specify the options that you require to change, and all the other options will remain the same as they are. However, with the **network\_connections** variable, you must specify all settings to change the network connection profile.

For example, to create an Ethernet connection with dynamic IP address settings, use the following **vars** block in your playbook:

Playbook with state configurations	Regular playbook
------------------------------------	------------------



```
vars:
  network_state:
  interfaces:
  - name: enp7s0
    type: ethernet
    state: up
  ipv4:
    enabled: true
    auto-dns: true
    auto-gateway: true
    auto-routes: true
    dhcp: true
  ipv6:
    enabled: true
    auto-dns: true
    auto-gateway: true
    auto-routes: true
    autoconf: true
    dhcp: true
```

```
vars:
  network_connections:
  - name: enp7s0
    interface_name: enp7s0
    type: ethernet
    autoconnect: yes
  ip:
    dhcp4: yes
    auto6: yes
  state: up
```

For example, to only change the connection status of dynamic IP address settings that you created as above, use the following **vars** block in your playbook:

Playbook with state configurations	Regular playbook
<pre>vars:   network_state:   interfaces:   - name: enp7s0     type: ethernet     state: down</pre>	<pre>vars:   network_connections:   - name: enp7s0     interface_name: enp7s0     type: ethernet     autoconnect: yes   ip:     dhcp4: yes     auto6: yes   state: down</pre>

#### Additional resources

- `/usr/share/ansible/roles/rhel-system-roles.network/README.md` file
- `/usr/share/doc/rhel-system-roles/network/` directory

## 39.4. ADDITIONAL RESOURCES

- `/usr/share/doc/nmstate/README.md`
- `/usr/share/doc/nmstate/examples/`

## CHAPTER 40. USING AND CONFIGURING FIREWALLD

A *firewall* is a way to protect machines from any unwanted traffic from outside. It enables users to control incoming network traffic on host machines by defining a set of *firewall rules*. These rules are used to sort the incoming traffic and either block it or allow through.

**firewalld** is a firewall service daemon that provides a dynamic customizable host-based firewall with a D-Bus interface. Being dynamic, it enables creating, changing, and deleting the rules without the necessity to restart the firewall daemon each time the rules are changed.

**firewalld** uses the concepts of zones and services, that simplify the traffic management. Zones are predefined sets of rules. Network interfaces and sources can be assigned to a zone. The traffic allowed depends on the network your computer is connected to and the security level this network is assigned. Firewall services are predefined rules that cover all necessary settings to allow incoming traffic for a specific service and they apply within a zone.

Services use one or more ports or addresses for network communication. Firewalls filter communication based on ports. To allow network traffic for a service, its ports must be open. **firewalld** blocks all traffic on ports that are not explicitly set as open. Some zones, such as trusted, allow all traffic by default.

Note that **firewalld** with **nftables** backend does not support passing custom **nftables** rules to **firewalld**, using the **--direct** option.

### 40.1. WHEN TO USE FIREWALLD, NFTABLES, OR IPTABLES

The following is a brief overview in which scenario you should use one of the following utilities:

- **firewalld**: Use the **firewalld** utility for simple firewall use cases. The utility is easy to use and covers the typical use cases for these scenarios.
- **nftables**: Use the **nftables** utility to set up complex and performance-critical firewalls, such as for a whole network.
- **iptables**: The **iptables** utility on Red Hat Enterprise Linux uses the **nf\_tables** kernel API instead of the **legacy** back end. The **nf\_tables** API provides backward compatibility so that scripts that use **iptables** commands still work on Red Hat Enterprise Linux. For new firewall scripts, Red Hat recommends to use **nftables**.

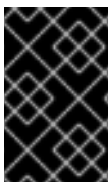

#### IMPORTANT

To prevent the different firewall-related services (**firewalld**, **nftables**, or **iptables**) from influencing each other, run only one of them on a RHEL host, and disable the other services.

### 40.2. FIREWALL ZONES

You can use the **firewalld** utility to separate networks into different zones according to the level of trust that you have with the interfaces and traffic within that network. A connection can only be part of one zone, but you can use that zone for many network connections.

**firewalld** follows strict principles in regards to zones:

1. Traffic ingresses only one zone.
2. Traffic egresses only one zone.

3. A zone defines a level of trust.
4. Intrazone traffic (within the same zone) is allowed by default.
5. Interzone traffic (from zone to zone) is denied by default.

Principles 4 and 5 are a consequence of principle 3.

Principle 4 is configurable through the zone option **--remove-forward**. Principle 5 is configurable by adding new policies.

**NetworkManager** notifies **firewalld** of the zone of an interface. You can assign zones to interfaces with the following utilities:

- **NetworkManager**
- **firewall-config** utility
- **firewall-cmd** utility
- The RHEL web console

The RHEL web console, **firewall-config**, and **firewall-cmd** can only edit the appropriate **NetworkManager** configuration files. If you change the zone of the interface using the web console, **firewall-cmd**, or **firewall-config**, the request is forwarded to **NetworkManager** and is not handled by **firewalld**.

The `/usr/lib/firewalld/zones/` directory stores the predefined zones, and you can instantly apply them to any available network interface. These files are copied to the `/etc/firewalld/zones/` directory only after they are modified. The default settings of the predefined zones are as follows:

#### **block**

- Suitable for: Any incoming network connections are rejected with an icmp-host-prohibited message for **IPv4** and icmp6-adm-prohibited for **IPv6**.
- Accepts: Only network connections initiated from within the system.

#### **dmz**

- Suitable for: Computers in your DMZ that are publicly-accessible with limited access to your internal network.
- Accepts: Only selected incoming connections.

#### **drop**

Suitable for: Any incoming network packets are dropped without any notification.

\*\*Accepts: Only outgoing network connections.

#### **external**

- Suitable for: External networks with masquerading enabled, especially for routers. Situations when you do not trust the other computers on the network.
- Accepts: Only selected incoming connections.

**home**

- Suitable for: Home environment where you mostly trust the other computers on the network.
- Accepts: Only selected incoming connections.

**internal**

- Suitable for: Internal networks where you mostly trust the other computers on the network.
- Accepts: Only selected incoming connections.

**public**

- Suitable for: Public areas where you do not trust other computers on the network.
- Accepts: Only selected incoming connections.

**trusted**

- Accepts: All network connections.

**work**

Suitable for: Work environment where you mostly trust the other computers on the network.

- Accepts: Only selected incoming connections.

One of these zones is set as the *default* zone. When interface connections are added to **NetworkManager**, they are assigned to the default zone. On installation, the default zone in **firewalld** is the **public** zone. You can change the default zone.

**NOTE**

Make network zone names self-explanatory to help users understand them quickly.

To avoid any security problems, review the default zone configuration and disable any unnecessary services according to your needs and risk assessments.

**Additional resources**

- The **firewalld.zone(5)** man page.

## 40.3. FIREWALL POLICIES

The firewall policies specify the desired security state of your network. They outline rules and actions to take for different types of traffic. Typically, the policies contain rules for the following types of traffic:

- Incoming traffic
- Outgoing traffic
- Forward traffic
- Specific services and applications

- Network address translations (NAT)

Firewall policies use the concept of firewall zones. Each zone is associated with a specific set of firewall rules that determine the traffic allowed. Policies apply firewall rules in a stateful, unidirectional manner. This means you only consider one direction of the traffic. The traffic return path is implicitly allowed due to stateful filtering of **firewalld**.

Policies are associated with an ingress zone and an egress zone. The ingress zone is where the traffic originated (received). The egress zone is where the traffic leaves (sent).

The firewall rules defined in a policy can reference the firewall zones to apply consistent configurations across multiple network interfaces.

## 40.4. FIREWALL RULES

You can use the firewall rules to implement specific configurations for allowing or blocking network traffic. As a result, you can control the flow of network traffic to protect your system from security threats.

Firewall rules typically define certain criteria based on various attributes. The attributes can be as:

- Source IP addresses
- Destination IP addresses
- Transfer Protocols (TCP, UDP, ...)
- Ports
- Network interfaces

The **firewalld** utility organizes the firewall rules into zones (such as **public**, **internal**, and others) and policies. Each zone has its own set of rules that determine the level of traffic freedom for network interfaces associated with a particular zone.

## 40.5. ZONE CONFIGURATION FILES

A **firewalld** zone configuration file contains the information for a zone. These are the zone description, services, ports, protocols, icmp-blocks, masquerade, forward-ports and rich language rules in an XML file format. The file name has to be **zone-name.xml** where the length of *zone-name* is currently limited to 17 chars. The zone configuration files are located in the **/usr/lib/firewalld/zones/** and **/etc/firewalld/zones/** directories.

The following example shows a configuration that allows one service (**SSH**) and one port range, for both the **TCP** and **UDP** protocols:

```
<?xml version="1.0" encoding="utf-8"?>
<zone>
  <short>My Zone</short>
  <description>Here you can describe the characteristic features of the zone.</description>
  <service name="ssh"/>
  <port protocol="udp" port="1025-65535"/>
  <port protocol="tcp" port="1025-65535"/>
</zone>
```

### Additional resources

- **firewalld.zone** manual page

## 40.6. PREDEFINED FIREWALLD SERVICES

The **firewalld** service is a predefined set of firewall rules that define access to a specific application or network service. Each service represents a combination of the following elements:

- Local port
- Network protocol
- Associated firewall rules
- Source ports and destinations
- Firewall helper modules that load automatically if a service is enabled

A service simplifies packet filtering and saves you time because it achieves several tasks at once. For example, **firewalld** can perform the following tasks at once:

- Open a port
- Define network protocol
- Enable packet forwarding

Service configuration options and generic file information are described in the **firewalld.service(5)** man page. The services are specified by means of individual XML configuration files, which are named in the following format: **service-name.xml**. Protocol names are preferred over service or application names in **firewalld**.

You can configure **firewalld** in the following ways:

- Use utilities:
  - **firewall-config** - graphical utility
  - **firewall-cmd** - command-line utility
  - **firewall-offline-cmd** - command-line utility
- Edit the XML files in the **/etc/firewalld/services/** directory.  
If you do not add or change the service, no corresponding XML file exists in **/etc/firewalld/services/**. You can use the files in **/usr/lib/firewalld/services/** as templates.

### Additional resources

- The **firewalld.service(5)** man page

## 40.7. WORKING WITH FIREWALLD ZONES

Zones represent a concept to manage incoming traffic more transparently. The zones are connected to networking interfaces or assigned a range of source addresses. You manage firewall rules for each zone independently, which enables you to define complex firewall settings and apply them to the traffic.

### 40.7.1. Customizing firewall settings for a specific zone to enhance security

You can strengthen your network security by modifying the firewall settings and associating a specific network interface or connection with a particular firewall zone. By defining granular rules and restrictions for a zone, you can control inbound and outbound traffic based on your intended security levels.

For example, you can achieve the following benefits:

- Protection of sensitive data
- Prevention of unauthorized access
- Mitigation of potential network threats

#### Prerequisites

- The **firewalld** service is running.

#### Procedure

1. List the available firewall zones:

```
# firewall-cmd --get-zones
```

The **firewall-cmd --get-zones** command displays all zones that are available on the system, but it does not show any details for particular zones. To see more detailed information for all zones, use the **firewall-cmd --list-all-zones** command.

2. Choose the zone you want to use for this configuration.
3. Modify firewall settings for the chosen zone. For example, to allow the **SSH** service and remove the **ftp** service:

```
# firewall-cmd --add-service=ssh --zone=<your_chosen_zone>
# firewall-cmd --remove-service=ftp --zone=<same_chosen_zone>
```

4. Assign a network interface to the firewall zone:

- a. List the available network interfaces:

```
# firewall-cmd --get-active-zones
```

Activity of a zone is determined by the presence of network interfaces or source address ranges that match its configuration. The default zone is active for unclassified traffic but is not always active if no traffic matches its rules.

- b. Assign a network interface to the chosen zone:

```
# firewall-cmd --zone=<your_chosen_zone> --change-interface=<interface_name> -
-permanent
```

Assigning a network interface to a zone is more suitable for applying consistent firewall settings to all traffic on a particular interface (physical or virtual).

The **firewall-cmd** command, when used with the **--permanent** option, often involves

updating NetworkManager connection profiles to make changes to the firewall configuration permanent. This integration between **firewalld** and NetworkManager ensures consistent network and firewall settings.

## Verification

1. Display the updated settings for your chosen zone:

```
# firewall-cmd --zone=<your_chosen_zone> --list-all
```

The command output displays all zone settings including the assigned services, network interface, and network connections (sources).

## 40.7.2. Changing the default zone

System administrators assign a zone to a networking interface in its configuration files. If an interface is not assigned to a specific zone, it is assigned to the default zone. After each restart of the **firewalld** service, **firewalld** loads the settings for the default zone and makes it active. Note that settings for all other zones are preserved and ready to be used.

Typically, zones are assigned to interfaces by NetworkManager according to the **connection.zone** setting in NetworkManager connection profiles. Also, after a reboot NetworkManager manages assignments for "activating" those zones.

## Prerequisites

- The **firewalld** service is running.

## Procedure

To set up the default zone:

1. Display the current default zone:

```
# firewall-cmd --get-default-zone
```

2. Set the new default zone:

```
# firewall-cmd --set-default-zone <zone_name>
```

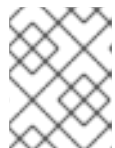

### NOTE

Following this procedure, the setting is a permanent setting, even without the **--permanent** option.

## 40.7.3. Assigning a network interface to a zone

It is possible to define different sets of rules for different zones and then change the settings quickly by changing the zone for the interface that is being used. With multiple interfaces, a specific zone can be set for each of them to distinguish traffic that is coming through them.

## Procedure

To assign the zone to a specific interface:



1. List the active zones and the interfaces assigned to them:

```
# firewall-cmd --get-active-zones
```

2. Assign the interface to a different zone:

```
# firewall-cmd --zone=zone_name --change-interface=interface_name --permanent
```

#### 40.7.4. Assigning a zone to a connection using nmcli

You can add a **firewalld** zone to a **NetworkManager** connection using the **nmcli** utility.

##### Procedure

1. Assign the zone to the **NetworkManager** connection profile:

```
# nmcli connection modify profile connection.zone zone_name
```

2. Activate the connection:

```
# nmcli connection up profile
```

#### 40.7.5. Manually assigning a zone to a network connection in a connection profile file

If you cannot use the **nmcli** utility to modify a connection profile, you can manually edit the corresponding file of the profile to assign a **firewalld** zone.



##### NOTE

Modifying the connection profile with the **nmcli** utility to assign a **firewalld** zone is more efficient. For details, see [Assigning a network interface to a zone](#) .

##### Procedure

1. Determine the path to the connection profile and its format:

```
# nmcli -f NAME,FILENAME connection
NAME  FILENAME
enp1s0 /etc/NetworkManager/system-connections/enp1s0.nmconnection
enp7s0 /etc/sysconfig/network-scripts/ifcfg-enp7s0
```

NetworkManager uses separate directories and file names for the different connection profile formats:

- Profiles in **/etc/NetworkManager/system-connections/<connection\_name>.nmconnection** files use the keyfile format.
- Profiles in **/etc/sysconfig/network-scripts/ifcfg-<interface\_name>** files use the ifcfg format.

2. Depending on the format, update the corresponding file:

- If the file uses the keyfile format, append **zone=<name>** to the **[connection]** section of the **/etc/NetworkManager/system-connections/<connection\_name>.nmconnection** file:

```
[connection]
...
zone=internal
```

- If the file uses the ifcfg format, append **ZONE=<name>** to the **/etc/sysconfig/network-scripts/ifcfg-<interface\_name>** file:

```
ZONE=internal
```

3. Reload the connection profiles:

```
# nmcli connection reload
```

4. Reactivate the connection profiles

```
# nmcli connection up <profile_name>
```

## Verification

- Display the zone of the interface, for example:

```
# firewall-cmd --get-zone-of-interface enp1s0
internal
```

### 40.7.6. Manually assigning a zone to a network connection in an ifcfg file

When the connection is managed by **NetworkManager**, it must be aware of a zone that it uses. For every network connection profile, a zone can be specified, which provides the flexibility of various firewall settings according to the location of the computer with portable devices. Thus, zones and settings can be specified for different locations, such as company or home.

#### Procedure

- To set a zone for a connection, edit the **/etc/sysconfig/network-scripts/ifcfg-connection\_name** file and add a line that assigns a zone to this connection:

```
ZONE=zone_name
```

### 40.7.7. Creating a new zone

To use custom zones, create a new zone and use it just like a predefined zone. New zones require the **--permanent** option, otherwise the command does not work.

#### Prerequisites

- The **firewalld** service is running.

#### Procedure

1. Create a new zone:

```
# firewall-cmd --permanent --new-zone=zone-name
```

2. Make the new zone usable:

```
# firewall-cmd --reload
```

The command applies recent changes to the firewall configuration without interrupting network services that are already running.

### Verification

- Check if the new zone is added to your permanent settings:

```
# firewall-cmd --get-zones --permanent
```

### 40.7.8. Using zone targets to set default behavior for incoming traffic

For every zone, you can set a default behavior that handles incoming traffic that is not further specified. Such behavior is defined by setting the target of the zone. There are four options:

- **ACCEPT**: Accepts all incoming packets except those disallowed by specific rules.
- **REJECT**: Rejects all incoming packets except those allowed by specific rules. When **firewalld** rejects packets, the source machine is informed about the rejection.
- **DROP**: Drops all incoming packets except those allowed by specific rules. When **firewalld** drops packets, the source machine is not informed about the packet drop.
- **default**: Similar behavior as for **REJECT**, but with special meanings in certain scenarios.

### Prerequisites

- The **firewalld** service is running.

### Procedure

To set a target for a zone:

1. List the information for the specific zone to see the default target:

```
# firewall-cmd --zone=zone-name --list-all
```

2. Set a new target in the zone:

```
# firewall-cmd --permanent --zone=zone-name --set-target=  
<default|ACCEPT|REJECT|DROP>
```

### Additional resources

- **firewall-cmd(1)** man page

## 40.8. CONTROLLING NETWORK TRAFFIC USING FIREWALLD

The **firewalld** package installs a large number of predefined service files and you can add more or customize them. You can then use these service definitions to open or close ports for services without knowing the protocol and port numbers they use.

### 40.8.1. Controlling traffic with predefined services using the CLI

The most straightforward method to control traffic is to add a predefined service to **firewalld**. This opens all necessary ports and modifies other settings according to the *service definition file*.

#### Prerequisites

- The **firewalld** service is running.

#### Procedure

1. Check that the service in **firewalld** is not already allowed:

```
# firewall-cmd --list-services
ssh dhcpv6-client
```

The command lists the services that are enabled in the default zone.

2. List all predefined services in **firewalld**:

```
# firewall-cmd --get-services
RH-Satellite-6 amanda-client amanda-k5-client bacula bacula-client bitcoin bitcoin-rpc
bitcoin-testnet bitcoin-testnet-rpc ceph ceph-mon cfengine condor-collector ctdb dhcp dhcpv6
dhcpv6-client dns docker-registry ...
```

The command displays a list of available services for the default zone.

3. Add the service to the list of services that **firewalld** allows:

```
# firewall-cmd --add-service=<service_name>
```

The command adds the specified service to the default zone.

4. Make the new settings persistent:

```
# firewall-cmd --runtime-to-permanent
```

The command applies these runtime changes to the permanent configuration of the firewall. By default, it applies these changes to the configuration of the default zone.

#### Verification

1. List all permanent firewall rules:

```
# firewall-cmd --list-all --permanent
public
target: default
icmp-block-inversion: no
```

```

interfaces:
sources:
services: cockpit dhcpv6-client ssh
ports:
protocols:
forward: no
masquerade: no
forward-ports:
source-ports:
icmp-blocks:
rich rules:

```

The command displays complete configuration with the permanent firewall rules of the default firewall zone (**public**).

2. Check the validity of the permanent configuration of the **firewalld** service.

```

# firewall-cmd --check-config
success

```

If the permanent configuration is invalid, the command returns an error with further details:

```

# firewall-cmd --check-config
Error: INVALID_PROTOCOL: 'public.xml': 'tcp' not from {'tcp'|'udp'|'sctp'|'dccp'}

```

You can also manually inspect the permanent configuration files to verify the settings. The main configuration file is **/etc/firewalld/firewalld.conf**. The zone-specific configuration files are in the **/etc/firewalld/zones/** directory and the policies are in the **/etc/firewalld/policies/** directory.

### 40.8.2. Controlling traffic with predefined services using the GUI

You can control the network traffic with predefined services using a graphical user interface. The Firewall Configuration application provides an accessible and user-friendly alternative to the command-line utilities.

#### Prerequisites

- You installed the **firewall-config** package.
- The **firewalld** service is running.

#### Procedure

1. To enable or disable a predefined or custom service:
  - a. Start the **firewall-config** utility and select the network zone whose services are to be configured.
  - b. Select the **Zones** tab and then the **Services** tab below.
  - c. Select the checkbox for each type of service you want to trust or clear the checkbox to block a service in the selected zone.
2. To edit a service:

- a. Start the **firewall-config** utility.
- b. Select **Permanent** from the menu labeled **Configuration**. Additional icons and menu buttons appear at the bottom of the **Services** window.
- c. Select the service you want to configure.

The **Ports**, **Protocols**, and **Source Port** tabs enable adding, changing, and removing of ports, protocols, and source port for the selected service. The modules tab is for configuring **Netfilter** helper modules. The **Destination** tab enables limiting traffic to a particular destination address and Internet Protocol (**IPv4** or **IPv6**).

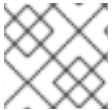

## NOTE

It is not possible to alter service settings in the **Runtime** mode.

## Verification

- Press the **Super** key to enter the Activities overview.
- Select the Firewall Configuration utility.
  - You can also start the graphical firewall configuration utility using the command-line, by entering the **firewall-config** command.
- View the list of configurations of your firewall:

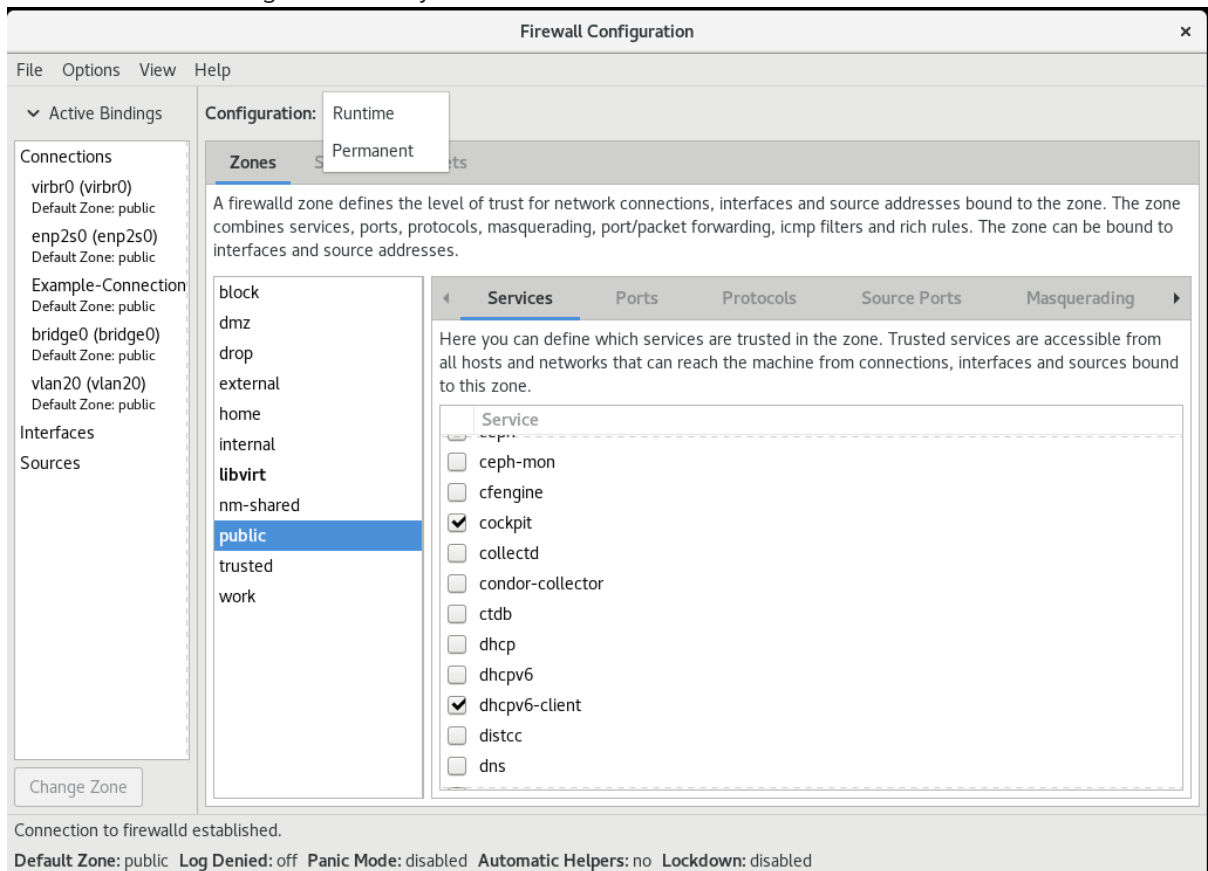

The **Firewall Configuration** window opens. Note that this command can be run as a normal user, but you are prompted for an administrator password occasionally.

### 40.8.3. Configuring firewalld to allow hosting a secure web server

Ports are logical services that enable an operating system to receive and distinguish network traffic and forward it to system services. The system services are represented by a daemon that listens on the port and waits for any traffic coming to this port.

Normally, system services listen on standard ports that are reserved for them. The **httpd** daemon, for example, listens on port 80. However, system administrators can directly specify the port number instead of the service name.

You can use the **firewalld** service to configure access to a secure web server for hosting your data.

### Prerequisites

- The **firewalld** service is running.

### Procedure

1. Check the currently active firewall zone:

```
# firewall-cmd --get-active-zones
```

2. Add the HTTPS service to the appropriate zone:

```
# firewall-cmd --zone=<zone_name> --add-service=https --permanent
```

3. Reload the firewall configuration:

```
# firewall-cmd --reload
```

### Verification

1. Check if the port is open in **firewalld**:
  - If you opened the port by specifying the port number, enter:

```
# firewall-cmd --zone=<zone_name> --list-all
```

- If you opened the port by specifying a service definition, enter:

```
# firewall-cmd --zone=<zone_name> --list-services
```

#### 40.8.4. Closing unused or unnecessary ports to enhance network security

When an open port is no longer needed, you can use the **firewalld** utility to close it.



#### IMPORTANT

Close all unnecessary ports to reduce the potential attack surface and minimize the risk of unauthorized access or exploitation of vulnerabilities.

### Procedure

1. List all allowed ports:

■

**# firewall-cmd --list-ports**

By default, this command lists the ports that are enabled in the default zone.

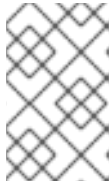
**NOTE**

This command will only give you a list of ports that are opened as ports. You will not be able to see any open ports that are opened as a service. For that case, consider using the **--list-all** option instead of **--list-ports**.

2. Remove the port from the list of allowed ports to close it for the incoming traffic:

**# firewall-cmd --remove-port=port-number/port-type**

This command removes a port from a zone. If you do not specify a zone, it will remove the port from the default zone.

3. Make the new settings persistent:

**# firewall-cmd --runtime-to-permanent**

Without specifying a zone, this command applies runtime changes to the permanent configuration of the default zone.

**Verification**

1. List the active zones and choose the zone you want to inspect:

**# firewall-cmd --get-active-zones**

2. List the currently open ports in the selected zone to check if the unused or unnecessary ports are closed:

**# firewall-cmd --zone=<zone\_to\_inspect> --list-ports****40.8.5. Controlling traffic through the CLI**

You can use the **firewall-cmd** command to:

- disable networking traffic
- enable networking traffic

As a result, you can for example enhance your system defenses, ensure data privacy or optimize network resources.

**IMPORTANT**

Enabling panic mode stops all networking traffic. For this reason, it should be used only when you have the physical access to the machine or if you are logged in using a serial console.

**Procedure**



1. To immediately disable networking traffic, switch panic mode on:

```
# firewall-cmd --panic-on
```

2. Switching off panic mode reverts the firewall to its permanent settings. To switch panic mode off, enter:

```
# firewall-cmd --panic-off
```

### Verification

- To see whether panic mode is switched on or off, use:

```
# firewall-cmd --query-panic
```

### 40.8.6. Controlling traffic with protocols using GUI

To permit traffic through the firewall using a certain protocol, you can use the GUI.

#### Prerequisites

- You installed the **firewall-config** package

#### Procedure

1. Start the **firewall-config** tool and select the network zone whose settings you want to change.
2. Select the **Protocols** tab and click the **Add** button on the right-hand side. The **Protocol** window opens.
3. Either select a protocol from the list or select the **Other Protocol** check box and enter the protocol in the field.

## 40.9. USING ZONES TO MANAGE INCOMING TRAFFIC DEPENDING ON A SOURCE

You can use zones to manage incoming traffic based on its source. Incoming traffic in this context is any data that is destined for your system, or passes through the host running **firewalld**. The source typically refers to the IP address or network range from which the traffic originates. As a result, you can sort incoming traffic and assign it to different zones to allow or disallow services that can be reached by that traffic.

Matching by source address takes precedence over matching by interface name. When you add a source to a zone, the firewall will prioritize the source-based rules for incoming traffic over interface-based rules. This means that if incoming traffic matches a source address specified for a particular zone, the zone associated with that source address will determine how the traffic is handled, regardless of the interface through which it arrives. On the other hand, interface-based rules are generally a fallback for traffic that does not match specific source-based rules. These rules apply to traffic, for which the source is not explicitly associated with a zone. This allows you to define a default behavior for traffic that does not have a specific source-defined zone.

### 40.9.1. Adding a source

To route incoming traffic into a specific zone, add the source to that zone. The source can be an IP address or an IP mask in the classless inter-domain routing (CIDR) notation.

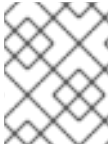

## NOTE

In case you add multiple zones with an overlapping network range, they are ordered alphanumerically by zone name and only the first one is considered.

- To set the source in the current zone:

```
# firewall-cmd --add-source=<source>
```

- To set the source IP address for a specific zone:

```
# firewall-cmd --zone=zone-name --add-source=<source>
```

The following procedure allows all incoming traffic from *192.168.2.15* in the **trusted** zone:

### Procedure

1. List all available zones:

```
# firewall-cmd --get-zones
```

2. Add the source IP to the trusted zone in the permanent mode:

```
# firewall-cmd --zone=trusted --add-source=192.168.2.15
```

3. Make the new settings persistent:

```
# firewall-cmd --runtime-to-permanent
```

### 40.9.2. Removing a source

When you remove a source from a zone, the traffic which originates from the source is no longer directed through the rules specified for that source. Instead, the traffic falls back to the rules and settings of the zone associated with the interface from which it originates, or goes to the default zone.

### Procedure

1. List allowed sources for the required zone:

```
# firewall-cmd --zone=zone-name --list-sources
```

2. Remove the source from the zone permanently:

```
# firewall-cmd --zone=zone-name --remove-source=<source>
```

3. Make the new settings persistent:

```
# firewall-cmd --runtime-to-permanent
```

### 40.9.3. Removing a source port

By removing a source port you disable sorting the traffic based on a port of origin.

#### Procedure

- To remove a source port:

```
# firewall-cmd --zone=zone-name --remove-source-port=<port-name>/<tcp|udp|sctp|dccp>
```

### 40.9.4. Using zones and sources to allow a service for only a specific domain

To allow traffic from a specific network to use a service on a machine, use zones and source. The following procedure allows only HTTP traffic from the **192.0.2.0/24** network while any other traffic is blocked.



#### WARNING

When you configure this scenario, use a zone that has the **default** target. Using a zone that has the target set to **ACCEPT** is a security risk, because for traffic from **192.0.2.0/24**, all network connections would be accepted.

#### Procedure

- List all available zones:

```
# firewall-cmd --get-zones
block dmz drop external home internal public trusted work
```

- Add the IP range to the **internal** zone to route the traffic originating from the source through the zone:

```
# firewall-cmd --zone=internal --add-source=192.0.2.0/24
```

- Add the **http** service to the **internal** zone:

```
# firewall-cmd --zone=internal --add-service=http
```

- Make the new settings persistent:

```
# firewall-cmd --runtime-to-permanent
```

#### Verification

- Check that the **internal** zone is active and that the service is allowed in it:

```
# firewall-cmd --zone=internal --list-all
```

```

internal (active)
target: default
icmp-block-inversion: no
interfaces:
sources: 192.0.2.0/24
services: cockpit dhcpv6-client mdns samba-client ssh http
...

```

### Additional resources

- `firewalld.zones(5)` man page

## 40.10. FILTERING FORWARDED TRAFFIC BETWEEN ZONES

**firewalld** enables you to control the flow of network data between different **firewalld** zones. By defining rules and policies, you can manage how traffic is allowed or blocked when it moves between these zones.

The policy objects feature provides forward and output filtering in **firewalld**. You can use **firewalld** to filter traffic between different zones to allow access to locally hosted VMs to connect the host.

### 40.10.1. The relationship between policy objects and zones

Policy objects allow the user to attach **firewalld**'s primitives such as services, ports, and rich rules to the policy. You can apply the policy objects to traffic that passes between zones in a stateful and unidirectional manner.

```

# firewall-cmd --permanent --new-policy myOutputPolicy

# firewall-cmd --permanent --policy myOutputPolicy --add-ingress-zone HOST

# firewall-cmd --permanent --policy myOutputPolicy --add-egress-zone ANY

```

**HOST** and **ANY** are the symbolic zones used in the ingress and egress zone lists.

- The **HOST** symbolic zone allows policies for the traffic originating from or has a destination to the host running **firewalld**.
- The **ANY** symbolic zone applies policy to all the current and future zones. **ANY** symbolic zone acts as a wildcard for all zones.

### 40.10.2. Using priorities to sort policies

Multiple policies can apply to the same set of traffic, therefore, priorities should be used to create an order of precedence for the policies that may be applied.

To set a priority to sort the policies:

```

# firewall-cmd --permanent --policy mypolicy --set-priority -500

```

In the above example **-500** is a lower priority value but has higher precedence. Thus, **-500** will execute before **-100**.

Lower numerical priority values have higher precedence and are applied first.

### 40.10.3. Using policy objects to filter traffic between locally hosted containers and a network physically connected to the host

The policy objects feature allows users to filter traffic between Podman and firewalld zones.



#### NOTE

Red Hat recommends blocking all traffic by default and opening the selective services needed for the Podman utility.

#### Procedure

1. Create a new firewall policy:

```
# firewall-cmd --permanent --new-policy podmanToAny
```

2. Block all traffic from Podman to other zones and allow only necessary services on Podman:

```
# firewall-cmd --permanent --policy podmanToAny --set-target REJECT
# firewall-cmd --permanent --policy podmanToAny --add-service dhcp
# firewall-cmd --permanent --policy podmanToAny --add-service dns
# firewall-cmd --permanent --policy podmanToAny --add-service https
```

3. Create a new Podman zone:

```
# firewall-cmd --permanent --new-zone=podman
```

4. Define the ingress zone for the policy:

```
# firewall-cmd --permanent --policy podmanToHost --add-ingress-zone podman
```

5. Define the egress zone for all other zones:

```
# firewall-cmd --permanent --policy podmanToHost --add-egress-zone ANY
```

Setting the egress zone to ANY means that you filter from Podman to other zones. If you want to filter to the host, then set the egress zone to HOST.

6. Restart the firewalld service:

```
# systemctl restart firewalld
```

#### Verification

- Verify the Podman firewall policy to other zones:

```
# firewall-cmd --info-policy podmanToAny
podmanToAny (active)
...
target: REJECT
ingress-zones: podman
```

```
egress-zones: ANY
services: dhcp dns https
...
```

#### 40.10.4. Setting the default target of policy objects

You can specify `--set-target` options for policies. The following targets are available:

- **ACCEPT** - accepts the packet
- **DROP** - drops the unwanted packets
- **REJECT** - rejects unwanted packets with an ICMP reply
- **CONTINUE** (default) - packets will be subject to rules in following policies and zones.

```
# firewall-cmd --permanent --policy mypolicy --set-target CONTINUE
```

#### Verification

- Verify information about the policy

```
# firewall-cmd --info-policy mypolicy
```

#### 40.10.5. Using DNAT to forward HTTPS traffic to a different host

If your web server runs in a DMZ with private IP addresses, you can configure destination network address translation (DNAT) to enable clients on the internet to connect to this web server. In this case, the host name of the web server resolves to the public IP address of the router. When a client establishes a connection to a defined port on the router, the router forwards the packets to the internal web server.

#### Prerequisites

- The DNS server resolves the host name of the web server to the router's IP address.
- You know the following settings:
  - The private IP address and port number that you want to forward
  - The IP protocol to be used
  - The destination IP address and port of the web server where you want to redirect the packets

#### Procedure

1. Create a firewall policy:

```
# firewall-cmd --permanent --new-policy <example_policy>
```

The policies, as opposed to zones, allow packet filtering for input, output, and forwarded traffic. This is important, because forwarding traffic to endpoints on locally run web servers, containers, or virtual machines requires such capability.

2. Configure symbolic zones for the ingress and egress traffic to also enable the router itself to connect to its local IP address and forward this traffic:

```
# firewall-cmd --permanent --policy=<example_policy> --add-ingress-zone=HOST
# firewall-cmd --permanent --policy=<example_policy> --add-egress-zone=ANY
```

The `--add-ingress-zone=HOST` option refers to packets generated locally and transmitted out of the local host. The `--add-egress-zone=ANY` option refers to traffic moving to any zone.

3. Add a rich rule that forwards traffic to the web server:

```
# firewall-cmd --permanent --policy=<example_policy> --add-rich-rule='rule
family="ipv4" destination address="192.0.2.1" forward-port port="443" protocol="tcp"
to-port="443" to-addr="192.51.100.20"
```

The rich rule forwards TCP traffic from port 443 on the IP address of the router (192.0.2.1) to port 443 of the IP address of the web server (192.51.100.20).

4. Reload the firewall configuration files:

```
# firewall-cmd --reload
success
```

5. Activate routing of 127.0.0.0/8 in the kernel:

- For persistent changes, run:

```
# echo "net.ipv4.conf.all.route_localnet=1" > /etc/sysctl.d/90-enable-route-
localnet.conf
```

The command persistently configures the `route_localnet` kernel parameter and ensures that the setting is preserved after the system reboots.

- For applying the settings immediately without a system reboot, run:

```
# sysctl -p /etc/sysctl.d/90-enable-route-localnet.conf
```

The `sysctl` command is useful for applying on-the-fly changes, however the configuration will not persist across system reboots.

## Verification

1. Connect to the IP address of the router and to the port that you have forwarded to the web server:

```
# curl https://192.0.2.1:443
```

2. Optional: Verify that the `net.ipv4.conf.all.route_localnet` kernel parameter is active:

```
# sysctl net.ipv4.conf.all.route_localnet
net.ipv4.conf.all.route_localnet = 1
```

3. Verify that `<example_policy>` is active and contains the settings you need, especially the source IP address and port, protocol to be used, and the destination IP address and port:

```
# firewall-cmd --info-policy=<example_policy>
example_policy (active)
  priority: -1
  target: CONTINUE
  ingress-zones: HOST
  egress-zones: ANY
  services:
  ports:
  protocols:
  masquerade: no
  forward-ports:
  source-ports:
  icmp-blocks:
  rich rules:
  rule family="ipv4" destination address="192.0.2.1" forward-port port="443" protocol="tcp" to-port="443" to-addr="192.51.100.20"
```

### Additional resources

- **firewall-cmd(1)**, **firewalld.policies(5)**, **firewalld.richlanguage(5)**, **sysctl(8)**, and **sysctl.conf(5)** man pages
- [Using configuration files in /etc/sysctl.d/ to adjust kernel parameters](#)

## 40.11. CONFIGURING NAT USING FIREWALLD

With **firewalld**, you can configure the following network address translation (NAT) types:

- Masquerading
- Destination NAT (DNAT)
- Redirect

### 40.11.1. Network address translation types

These are the different network address translation (NAT) types:

#### Masquerading

Use one of these NAT types to change the source IP address of packets. For example, Internet Service Providers (ISPs) do not route private IP ranges, such as **10.0.0.0/8**. If you use private IP ranges in your network and users should be able to reach servers on the internet, map the source IP address of packets from these ranges to a public IP address.

Masquerading automatically uses the IP address of the outgoing interface. Therefore, use masquerading if the outgoing interface uses a dynamic IP address.

#### Destination NAT (DNAT)

Use this NAT type to rewrite the destination address and port of incoming packets. For example, if your web server uses an IP address from a private IP range and is, therefore, not directly accessible from the internet, you can set a DNAT rule on the router to redirect incoming traffic to this server.

#### Redirect



This type is a special case of DNAT that redirects packets to a different port on the local machine. For example, if a service runs on a different port than its standard port, you can redirect incoming traffic from the standard port to this specific port.

### 40.11.2. Configuring IP address masquerading

You can enable IP masquerading on your system. IP masquerading hides individual machines behind a gateway when accessing the internet.

#### Procedure

1. To check if IP masquerading is enabled (for example, for the **external** zone), enter the following command as **root**:

```
# firewall-cmd --zone=external --query-masquerade
```

The command prints **yes** with exit status **0** if enabled. It prints **no** with exit status **1** otherwise. If **zone** is omitted, the default zone will be used.

2. To enable IP masquerading, enter the following command as **root**:

```
# firewall-cmd --zone=external --add-masquerade
```

3. To make this setting persistent, pass the **--permanent** option to the command.
4. To disable IP masquerading, enter the following command as **root**:

```
# firewall-cmd --zone=external --remove-masquerade
```

To make this setting permanent, pass the **--permanent** option to the command.

### 40.11.3. Using DNAT to forward incoming HTTP traffic

You can use destination network address translation (DNAT) to direct incoming traffic from one destination address and port to another. Typically, this is useful for redirecting incoming requests from an external network interface to specific internal servers or services.

#### Prerequisites

- The **firewalld** service is running.

#### Procedure

1. Create the **/etc/sysctl.d/90-enable-IP-forwarding.conf** file with the following content:

```
net.ipv4.ip_forward=1
```

This setting enables IP forwarding in the kernel. It makes the internal RHEL server act as a router and forward packets from network to network.

2. Load the setting from the **/etc/sysctl.d/90-enable-IP-forwarding.conf** file:

```
# sysctl -p /etc/sysctl.d/90-enable-IP-forwarding.conf
```

### 3. Forward incoming HTTP traffic:

```
# firewall-cmd --zone=public --add-forward-  
port=port=80:proto=tcp:toaddr=198.51.100.10:toport=8080 --permanent
```

The previous command defines a DNAT rule with the following settings:

- **--zone=public** - The firewall zone for which you configure the DNAT rule. You can adjust this to whatever zone you need.
- **--add-forward-port** - The option that indicates you are adding a port-forwarding rule.
- **port=80** - The external destination port.
- **proto=tcp** - The protocol indicating that you forward TCP traffic.
- **toaddr=198.51.100.10** - The destination IP address.
- **toport=8080** - The destination port of the internal server.
- **--permanent** - The option that makes the DNAT rule persistent across reboots.

### 4. Reload the firewall configuration to apply the changes:

```
# firewall-cmd --reload
```

## Verification

- Verify the DNAT rule for the firewall zone that you used:

```
# firewall-cmd --list-forward-ports --zone=public  
port=80:proto=tcp:toport=8080:toaddr=198.51.100.10
```

Alternatively, view the corresponding XML configuration file:

```
# cat /etc/firewalld/zones/public.xml  
<?xml version="1.0" encoding="utf-8"?>  
<zone>  
  <short>Public</short>  
  <description>For use in public areas. You do not trust the other computers on networks to  
not harm your computer. Only selected incoming connections are accepted.</description>  
  <service name="ssh"/>  
  <service name="dhcpv6-client"/>  
  <service name="cockpit"/>  
  <forward-port port="80" protocol="tcp" to-port="8080" to-addr="198.51.100.10"/>  
  <forward/>  
</zone>
```

## Additional resources

- [Configuring kernel parameters at runtime](#)
- **firewall-cmd(1)** manual page

## 40.11.4. Redirecting traffic from a non-standard port to make the web service accessible on a standard port

You can use the redirect mechanism to make the web service that internally runs on a non-standard port accessible without requiring users to specify the port in the URL. As a result, the URLs are simpler and provide better browsing experience, while a non-standard port is still used internally or for specific requirements.

### Prerequisites

- The **firewalld** service is running.

### Procedure

1. Create the **/etc/sysctl.d/90-enable-IP-forwarding.conf** file with the following content:

```
net.ipv4.ip_forward=1
```

This setting enables IP forwarding in the kernel.

2. Load the setting from the **/etc/sysctl.d/90-enable-IP-forwarding.conf** file:

```
# sysctl -p /etc/sysctl.d/90-enable-IP-forwarding.conf
```

3. Create the NAT redirect rule:

```
# firewall-cmd --zone=public --add-forward-  
port=port=<standard_port>;proto=tcp;toport=<non_standard_port> --permanent
```

The previous command defines the NAT redirect rule with the following settings:

- **--zone=public** - The firewall zone, for which you configure the rule. You can adjust this to whatever zone you need.
  - **--add-forward-port=port=<non\_standard\_port>** - The option that indicates you are adding a port-forwarding (redirecting) rule with source port on which you initially receive the incoming traffic.
  - **proto=tcp** - The protocol indicating that you redirect TCP traffic.
  - **toport=<standard\_port>** - The destination port, to which the incoming traffic should be redirected after being received on the source port.
  - **--permanent** - The option that makes the rule persist across reboots.
4. Reload the firewall configuration to apply the changes:

```
# firewall-cmd --reload
```

### Verification

- Verify the redirect rule for the firewall zone that you used:

```
# firewall-cmd --list-forward-ports
port=8080:proto=tcp:toport=80:toaddr=
```

Alternatively, view the corresponding XML configuration file:

```
# cat /etc/firewalld/zones/public.xml
<?xml version="1.0" encoding="utf-8"?>
<zone>
  <short>Public</short>
  <description>For use in public areas. You do not trust the other computers on networks to
not harm your computer. Only selected incoming connections are accepted.</description>
  <service name="ssh"/>
  <service name="dhcpv6-client"/>
  <service name="cockpit"/>
  <forward-port port="8080" protocol="tcp" to-port="80"/>
  <forward/>
</zone>
```

### Additional resources

- [Configuring kernel parameters at runtime](#)
- **firewall-cmd(1)** manual page

## 40.12. MANAGING ICMP REQUESTS

The **Internet Control Message Protocol (ICMP)** is a supporting protocol that is used by various network devices for testing, troubleshooting, and diagnostics. **ICMP** differs from transport protocols such as TCP and UDP because it is not used to exchange data between systems.

You can use the **ICMP** messages, especially **echo-request** and **echo-reply**, to reveal information about a network and misuse such information for various kinds of fraudulent activities. Therefore, **firewalld** enables controlling the **ICMP** requests to protect your network information.

### 40.12.1. Configuring ICMP filtering

You can use ICMP filtering to define which ICMP types and codes you want the firewall to permit or deny from reaching your system. ICMP types and codes are specific categories and subcategories of ICMP messages.

ICMP filtering helps, for example, in the following areas:

- Security enhancement - Block potentially harmful ICMP types and codes to reduce your attack surface.
- Network performance - Permit only necessary ICMP types to optimize network performance and prevent potential network congestion caused by excessive ICMP traffic.
- Troubleshooting control - Maintain essential ICMP functionality for network troubleshooting and block ICMP types that represent potential security risk.

### Prerequisites

- The **firewalld** service is running.

## Procedure

1. List available ICMP types and codes:

```
# firewall-cmd --get-icmpatypes
address-unreachable bad-header beyond-scope communication-prohibited destination-
unreachable echo-reply echo-request failed-policy fragmentation-needed host-precedence-
violation host-prohibited host-redirect host-unknown host-unreachable
...
```

From this predefined list, select which ICMP types and codes to allow or block.

2. Filter specific ICMP types by:

- Allowing ICMP types:

```
# firewall-cmd --zone=<target-zone> --remove-icmp-block=echo-request --
permanent
```

The command removes any existing blocking rules for the echo requests ICMP type.

- Blocking ICMP types:

```
# firewall-cmd --zone=<target-zone> --add-icmp-block=redirect --permanent
```

The command ensures that the redirect messages ICMP type is blocked by the firewall.

3. Reload the firewall configuration to apply the changes:

```
# firewall-cmd --reload
```

## Verification

- Verify your filtering rules are in effect:

```
# firewall-cmd --list-icmp-blocks
redirect
```

The command output displays the ICMP types and codes that you allowed or blocked.

## Additional resources

- [firewall-cmd\(1\)](#) manual page

## 40.13. SETTING AND CONTROLLING IP SETS USING FIREWALLD

IP sets are a RHEL feature for grouping of IP addresses and networks into sets to achieve more flexible and efficient firewall rule management.

The IP sets are valuable in scenarios when you need to for example:

- Handle large lists of IP addresses
- Implement dynamic updates to those large lists of IP addresses

- Create custom IP-based policies to enhance network security and control

**WARNING**

Red Hat recommends using the **firewall-cmd** command to create and manage IP sets.

### 40.13.1. Configuring dynamic updates for allowlisting with IP sets

You can make near real-time updates to flexibly allow specific IP addresses or ranges in the IP sets even in unpredictable conditions. These updates can be triggered by various events, such as detection of security threats or changes in the network behavior. Typically, such a solution leverages automation to reduce manual effort and improve security by responding quickly to the situation.

#### Prerequisites

- The **firewalld** service is running.

#### Procedure

1. Create an IP set with a meaningful name:

```
# firewall-cmd --permanent --new-ipset=allowlist --type=hash:ip
```

The new IP set called **allowlist** contains IP addresses that you want your firewall to allow.

2. Add a dynamic update to the IP set:

```
# firewall-cmd --permanent --ipset=allowlist --add-entry=198.51.100.10
```

This configuration updates the **allowlist** IP set with a newly added IP address that is allowed to pass network traffic by your firewall.

3. Create a firewall rule that references the previously created IP set:

```
# firewall-cmd --permanent --zone=public --add-source=ipset:allowlist
```

Without this rule, the IP set would not have any impact on network traffic. The default firewall policy would prevail.

4. Reload the firewall configuration to apply the changes:

```
# firewall-cmd --reload
```

#### Verification

1. List all IP sets:

```
# firewall-cmd --get-ipsets
allowlist
```

- List the active rules:

```
# firewall-cmd --list-all
public (active)
target: default
icmp-block-inversion: no
interfaces: enp0s1
sources: ipset:allowlist
services: cockpit dhcpv6-client ssh
ports:
protocols:
...
```

The **sources** section of the command-line output provides insights to what origins of traffic (hostnames, interfaces, IP sets, subnets, and others) are permitted or denied access to a particular firewall zone. In this case, the IP addresses contained in the **allowlist** IP set are allowed to pass traffic through the firewall for the **public** zone.

- Explore the contents of your IP set:

```
# cat /etc/firewalld/ipsets/allowlist.xml
<?xml version="1.0" encoding="utf-8"?>
<ipset type="hash:ip">
  <entry>198.51.100.10</entry>
</ipset>
```

### Next steps

- Use a script or a security utility to fetch your threat intelligence feeds and update **allowlist** accordingly in an automated fashion.

### Additional resources

- firewall-cmd(1)** manual page

## 40.14. PRIORITIZING RICH RULES

By default, rich rules are organized based on their rule action. For example, **deny** rules have precedence over **allow** rules. The **priority** parameter in rich rules provides administrators fine-grained control over rich rules and their execution order. When using the **priority** parameter, rules are sorted first by their priority values in ascending order. When more rules have the same **priority**, their order is determined by the rule action, and if the action is also the same, the order may be undefined.

### 40.14.1. How the priority parameter organizes rules into different chains

You can set the **priority** parameter in a rich rule to any number between **-32768** and **32767**, and lower numerical values have higher precedence.

The **firewalld** service organizes rules based on their priority value into different chains:

- Priority lower than 0: the rule is redirected into a chain with the **\_pre** suffix.

- Priority higher than 0: the rule is redirected into a chain with the **\_post** suffix.
- Priority equals 0: based on the action, the rule is redirected into a chain with the **\_log**, **\_deny**, or **\_allow** the action.

Inside these sub-chains, **firewalld** sorts the rules based on their priority value.

### 40.14.2. Setting the priority of a rich rule

The following is an example of how to create a rich rule that uses the **priority** parameter to log all traffic that is not allowed or denied by other rules. You can use this rule to flag unexpected traffic.

#### Procedure

- Add a rich rule with a very low precedence to log all traffic that has not been matched by other rules:

```
# firewall-cmd --add-rich-rule='rule priority=32767 log prefix="UNEXPECTED: " limit value="5/m"'
```

The command additionally limits the number of log entries to **5** per minute.

#### Verification

- Display the **nftables** rule that the command in the previous step created:

```
# nft list chain inet firewalld filter_IN_public_post
table inet firewalld {
  chain filter_IN_public_post {
    log prefix "UNEXPECTED: " limit rate 5/minute
  }
}
```

## 40.15. CONFIGURING FIREWALL LOCKDOWN

Local applications or services are able to change the firewall configuration if they are running as **root** (for example, **libvirt**). With this feature, the administrator can lock the firewall configuration so that either no applications or only applications that are added to the lockdown allow list are able to request firewall changes. The lockdown settings default to disabled. If enabled, the user can be sure that there are no unwanted configuration changes made to the firewall by local applications or services.

### 40.15.1. Configuring lockdown using CLI

You can enable or disable the lockdown feature using the command line.

#### Procedure

1. To query whether lockdown is enabled:

```
# firewall-cmd --query-lockdown
```

2. Manage lockdown configuration by either:



- Enabling lockdown:

```
# firewall-cmd --lockdown-on
```

- Disabling lockdown:

```
# firewall-cmd --lockdown-off
```

### 40.15.2. Overview of lockdown allowlist configuration files

The default allowlist configuration file contains the **NetworkManager** context and the default context of **libvirt**. The user ID 0 is also on the list.

The allowlist configuration files are stored in the **/etc/firewalld/** directory.

```
<?xml version="1.0" encoding="utf-8"?>
<whitelist>
  <command name="/usr/bin/python3 -s /usr/bin/firewall-config"/>
  <selinux context="system_u:system_r:NetworkManager_t:s0"/>
  <selinux context="system_u:system_r:virtld_t:s0-s0:c0.c1023"/>
  <user id="0"/>
</whitelist>
```

Following is an example allowlist configuration file enabling all commands for the **firewall-cmd** utility, for a user called *user* whose user ID is **815**:

```
<?xml version="1.0" encoding="utf-8"?>
<whitelist>
  <command name="/usr/libexec/platform-python -s /bin/firewall-cmd*"/>
  <selinux context="system_u:system_r:NetworkManager_t:s0"/>
  <user id="815"/>
  <user name="user"/>
</whitelist>
```

This example shows both **user id** and **user name**, but only one option is required. Python is the interpreter and is prepended to the command line.

In Red Hat Enterprise Linux, all utilities are placed in the **/usr/bin/** directory and the **/bin/** directory is sym-linked to the **/usr/bin/** directory. In other words, although the path for **firewall-cmd** when entered as **root** might resolve to **/bin/firewall-cmd**, **/usr/bin/firewall-cmd** can now be used. All new scripts should use the new location. But be aware that if scripts that run as **root** are written to use the **/bin/firewall-cmd** path, then that command path must be added in the allowlist in addition to the **/usr/bin/firewall-cmd** path traditionally used only for non- **root** users.

The **\*** at the end of the name attribute of a command means that all commands that start with this string match. If the **\*** is not there then the absolute command including arguments must match.

## 40.16. ENABLING TRAFFIC FORWARDING BETWEEN DIFFERENT INTERFACES OR SOURCES WITHIN A FIREWALLD ZONE

Intra-zone forwarding is a **firewalld** feature that enables traffic forwarding between interfaces or sources within a **firewalld** zone.

### 40.16.1. The difference between intra-zone forwarding and zones with the default target set to ACCEPT

With intra-zone forwarding enabled, the traffic within a single **firewalld** zone can flow from one interface or source to another interface or source. The zone specifies the trust level of interfaces and sources. If the trust level is the same, the traffic stays inside the same zone.

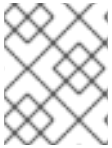

#### NOTE

Enabling intra-zone forwarding in the default zone of **firewalld**, applies only to the interfaces and sources added to the current default zone.

**firewalld** uses different zones to manage incoming and outgoing traffic. Each zone has its own set of rules and behaviors. For example, the **trusted** zone, allows all forwarded traffic by default.

Other zones can have different default behaviors. In standard zones, forwarded traffic is typically dropped by default when the target of the zone is set to **default**.

To control how the traffic is forwarded between different interfaces or sources within a zone, make sure you understand and configure the target of the zone accordingly.

### 40.16.2. Using intra-zone forwarding to forward traffic between an Ethernet and Wi-Fi network

You can use intra-zone forwarding to forward traffic between interfaces and sources within the same **firewalld** zone. This feature brings the following benefits:

- Seamless connectivity between wired and wireless devices (you can forward traffic between an Ethernet network connected to **enp1s0** and a Wi-Fi network connected to **wlp0s20**)
- Support for flexible work environments
- Shared resources that are accessible and used by multiple devices or users within a network (such as printers, databases, network-attached storage, and others)
- Efficient internal networking (such as smooth communication, reduced latency, resource accessibility, and others)

You can enable this functionality for individual **firewalld** zones.

#### Procedure

1. Enable packet forwarding in the kernel:

```
# echo "net.ipv4.ip_forward=1" > /etc/sysctl.d/95-IPv4-forwarding.conf
# sysctl -p /etc/sysctl.d/95-IPv4-forwarding.conf
```

2. Ensure that interfaces between which you want to enable intra-zone forwarding are assigned only to the **internal** zone:

```
# firewall-cmd --get-active-zones
```

3. If the interface is currently assigned to a zone other than **internal**, reassign it:

```
# firewall-cmd --zone=internal --change-interface=interface_name --permanent
```

4. Add the **enp1s0** and **wlp0s20** interfaces to the **internal** zone:

```
# firewall-cmd --zone=internal --add-interface=enp1s0 --add-interface=wlp0s20
```

5. Enable intra-zone forwarding:

```
# firewall-cmd --zone=internal --add-forward
```

## Verification

The following verification steps require that the **nmap-ncat** package is installed on both hosts.

1. Log in to a host that is on the same network as the **enp1s0** interface of the host on which you enabled zone forwarding.
2. Start an echo service with **ncat** to test connectivity:

```
# ncat -e /usr/bin/cat -l 12345
```

3. Log in to a host that is in the same network as the **wlp0s20** interface.
4. Connect to the echo server running on the host that is in the same network as the **enp1s0**:

```
# ncat <other_host> 12345
```

5. Type something and press **Enter**. Verify the text is sent back.

## Additional resources

- [firewalld.zones\(5\)](#) man page

## 40.17. CONFIGURING FIREWALLD BY USING RHEL SYSTEM ROLES

You can use the **firewall** RHEL system role to configure settings of the **firewalld** service on multiple clients at once. This solution:

- Provides an interface with efficient input settings.
- Keeps all intended **firewalld** parameters in one place.

After you run the **firewall** role on the control node, the RHEL system role applies the **firewalld** parameters to the managed node immediately and makes them persistent across reboots.

### 40.17.1. Introduction to the firewall RHEL system role

RHEL system roles is a set of contents for the Ansible automation utility. This content together with the Ansible automation utility provides a consistent configuration interface to remotely manage multiple systems.

The **rhel-system-roles.firewall** role from the RHEL system roles was introduced for automated configurations of the **firewalld** service. The **rhel-system-roles** package contains this RHEL system role, and also the reference documentation.

To apply the **firewalld** parameters on one or more systems in an automated fashion, use the **firewall** RHEL system role variable in a playbook. A playbook is a list of one or more plays that is written in the text-based YAML format.

You can use an inventory file to define a set of systems that you want Ansible to configure.

With the **firewall** role you can configure many different **firewalld** parameters, for example:

- Zones.
- The services for which packets should be allowed.
- Granting, rejection, or dropping of traffic access to ports.
- Forwarding of ports or port ranges for a zone.

#### Additional resources

- [/usr/share/ansible/roles/rhel-system-roles.firewall/README.md](#) file
- [/usr/share/doc/rhel-system-roles/firewall/](#) directory
- [Working with playbooks](#)
- [How to build your inventory](#)

### 40.17.2. Resetting the firewalld settings by using a RHEL system role

With the **firewall** RHEL system role, you can reset the **firewalld** settings to their default state. If you add the **previous:replaced** parameter to the variable list, the RHEL system role removes all existing user-defined settings and resets **firewalld** to the defaults. If you combine the **previous:replaced** parameter with other settings, the **firewall** role removes all existing settings before applying new ones.

Perform this procedure on the Ansible control node.

#### Prerequisites

- [You have prepared the control node and the managed nodes](#)
- You are logged in to the control node as a user who can run playbooks on the managed nodes.
- The account you use to connect to the managed nodes has **sudo** permissions on them.

#### Procedure

1. Create a playbook file, for example `~/playbook.yml`, with the following content:

```
---
- name: Reset firewalld example
  hosts: managed-node-01.example.com
  tasks:
    - name: Reset firewalld
```

```

ansible.builtin.include_role:
  name: rhel-system-roles.firewall
vars:
  firewall:
    - previous: replaced

```

2. Validate the playbook syntax:

```
$ ansible-playbook --syntax-check ~/playbook.yml
```

Note that this command only validates the syntax and does not protect against a wrong but valid configuration.

3. Run the playbook:

```
$ ansible-playbook ~/playbook.yml
```

### Verification

- Run this command as **root** on the managed node to check all the zones:

```
# firewall-cmd --list-all-zones
```

### Additional resources

- `/usr/share/ansible/roles/rhel-system-roles.firewall/README.md` file
- `/usr/share/doc/rhel-system-roles/firewall/` directory

## 40.17.3. Forwarding incoming traffic in firewalld from one local port to a different local port by using a RHEL system role

With the **firewall** role you can remotely configure **firewalld** parameters with persisting effect on multiple managed hosts.

Perform this procedure on the Ansible control node.

### Prerequisites

- [You have prepared the control node and the managed nodes](#)
- You are logged in to the control node as a user who can run playbooks on the managed nodes.
- The account you use to connect to the managed nodes has **sudo** permissions on them.

### Procedure

1. Create a playbook file, for example `~/playbook.yml`, with the following content:

```

---
- name: Configure firewalld
  hosts: managed-node-01.example.com
  tasks:

```

```
- name: Forward incoming traffic on port 8080 to 443
  ansible.builtin.include_role:
    name: rhel-system-roles.firewall
  vars:
    firewall:
      - { forward_port: 8080/tcp;443;, state: enabled, runtime: true, permanent: true }
```

2. Validate the playbook syntax:

```
$ ansible-playbook --syntax-check ~/playbook.yml
```

Note that this command only validates the syntax and does not protect against a wrong but valid configuration.

3. Run the playbook:

```
$ ansible-playbook ~/playbook.yml
```

## Verification

- On the managed host, display the **firewalld** settings:

```
# firewall-cmd --list-forward-ports
```

## Additional resources

- `/usr/share/ansible/roles/rhel-system-roles.firewall/README.md` file
- `/usr/share/doc/rhel-system-roles/firewall/` directory

### 40.17.4. Managing ports in firewalld by using a RHEL system role

You can use the **firewall** RHEL system role to open or close ports in the local firewall for incoming traffic and make the new configuration persist across reboots. For example you can configure the default zone to permit incoming traffic for the HTTPS service.

Perform this procedure on the Ansible control node.

## Prerequisites

- [You have prepared the control node and the managed nodes](#)
- You are logged in to the control node as a user who can run playbooks on the managed nodes.
- The account you use to connect to the managed nodes has **sudo** permissions on them.

## Procedure

1. Create a playbook file, for example `~/playbook.yml`, with the following content:

```
---
- name: Configure firewalld
  hosts: managed-node-01.example.com
```

```

tasks:
  - name: Allow incoming HTTPS traffic to the local host
    ansible.builtin.include_role:
      name: rhel-system-roles.firewall
  vars:
    firewall:
      - port: 443/tcp
        service: http
        state: enabled
        runtime: true
        permanent: true

```

The **permanent: true** option makes the new settings persistent across reboots.

2. Validate the playbook syntax:

```
$ ansible-playbook --syntax-check ~/playbook.yml
```

Note that this command only validates the syntax and does not protect against a wrong but valid configuration.

3. Run the playbook:

```
$ ansible-playbook ~/playbook.yml
```

## Verification

- On the managed node, verify that the **443/tcp** port associated with the **HTTPS** service is open:

```
# firewall-cmd --list-ports
443/tcp
```

## Additional resources

- `/usr/share/ansible/roles/rhel-system-roles.firewall/README.md` file
- `/usr/share/doc/rhel-system-roles/firewall/` directory

### 40.17.5. Configuring a firewalld DMZ zone by using a RHEL system role

As a system administrator, you can use the **firewall** RHEL system role to configure a **dmz** zone on the **enp1s0** interface to permit **HTTPS** traffic to the zone. In this way, you enable external users to access your web servers.

Perform this procedure on the Ansible control node.

## Prerequisites

- You have prepared the control node and the managed nodes
- You are logged in to the control node as a user who can run playbooks on the managed nodes.
- The account you use to connect to the managed nodes has **sudo** permissions on them.

## Procedure

1. Create a playbook file, for example `~/playbook.yml`, with the following content:

```
---
- name: Configure firewalld
  hosts: managed-node-01.example.com
  tasks:
    - name: Creating a DMZ with access to HTTPS port and masquerading for hosts in DMZ
      ansible.builtin.include_role:
        name: rhel-system-roles.firewall
      vars:
        firewall:
          - zone: dmz
            interface: enp1s0
            service: https
            state: enabled
            runtime: true
            permanent: true
```

2. Validate the playbook syntax:

```
$ ansible-playbook --syntax-check ~/playbook.yml
```

Note that this command only validates the syntax and does not protect against a wrong but valid configuration.

3. Run the playbook:

```
$ ansible-playbook ~/playbook.yml
```

## Verification

- On the managed node, view detailed information about the **dmz** zone:

```
# firewall-cmd --zone=dmz --list-all
dmz (active)
target: default
icmp-block-inversion: no
interfaces: enp1s0
sources:
services: https ssh
ports:
protocols:
forward: no
masquerade: no
forward-ports:
source-ports:
icmp-blocks:
```

## Additional resources

- `/usr/share/ansible/roles/rhel-system-roles.firewall/README.md` file



- `/usr/share/doc/rhel-system-roles/firewall/` directory

## CHAPTER 41. GETTING STARTED WITH NFTABLES

The **nftables** framework classifies packets and it is the successor to the **iptables**, **ip6tables**, **arptables**, **ebtables**, and **ipset** utilities. It offers numerous improvements in convenience, features, and performance over previous packet-filtering tools, most notably:

- Built-in lookup tables instead of linear processing
- A single framework for both the **IPv4** and **IPv6** protocols
- All rules applied atomically instead of fetching, updating, and storing a complete rule set
- Support for debugging and tracing in the rule set (**nftrace**) and monitoring trace events (in the **nft** tool)
- More consistent and compact syntax, no protocol-specific extensions
- A Netlink API for third-party applications

The **nftables** framework uses tables to store chains. The chains contain individual rules for performing actions. The **nft** utility replaces all tools from the previous packet-filtering frameworks. You can use the **libnftnl** library for low-level interaction with **nftables** Netlink API through the **libmnl** library.

To display the effect of rule set changes, use the **nft list ruleset** command. Because these utilities add tables, chains, rules, sets, and other objects to the **nftables** rule set, be aware that **nftables** rule-set operations, such as the **nft flush ruleset** command, might affect rule sets installed using the **iptables** command.

### 41.1. MIGRATING FROM IPTABLES TO NFTABLES

If your firewall configuration still uses **iptables** rules, you can migrate your **iptables** rules to **nftables**.

#### 41.1.1. When to use firewalld, nftables, or iptables

The following is a brief overview in which scenario you should use one of the following utilities:

- **firewalld**: Use the **firewalld** utility for simple firewall use cases. The utility is easy to use and covers the typical use cases for these scenarios.
- **nftables**: Use the **nftables** utility to set up complex and performance-critical firewalls, such as for a whole network.
- **iptables**: The **iptables** utility on Red Hat Enterprise Linux uses the **nf\_tables** kernel API instead of the **legacy** back end. The **nf\_tables** API provides backward compatibility so that scripts that use **iptables** commands still work on Red Hat Enterprise Linux. For new firewall scripts, Red Hat recommends to use **nftables**.



#### IMPORTANT

To prevent the different firewall-related services (**firewalld**, **nftables**, or **iptables**) from influencing each other, run only one of them on a RHEL host, and disable the other services.

#### 41.1.2. Converting iptables and ip6tables rule sets to nftables

Use the **iptables-restore-translate** and **ip6tables-restore-translate** utilities to translate **iptables** and **ip6tables** rule sets to **nftables**.

### Prerequisites

- The **nftables** and **iptables** packages are installed.
- The system has **iptables** and **ip6tables** rules configured.

### Procedure

1. Write the **iptables** and **ip6tables** rules to a file:

```
# iptables-save >/root/iptables.dump  
# ip6tables-save >/root/ip6tables.dump
```

2. Convert the dump files to **nftables** instructions:

```
# iptables-restore-translate -f /root/iptables.dump > /etc/nftables/ruleset-migrated-  
from-iptables.nft  
# ip6tables-restore-translate -f /root/ip6tables.dump > /etc/nftables/ruleset-migrated-  
from-ip6tables.nft
```

3. Review and, if needed, manually update the generated **nftables** rules.
4. To enable the **nftables** service to load the generated files, add the following to the **/etc/sysconfig/nftables.conf** file:

```
include "/etc/nftables/ruleset-migrated-from-iptables.nft"  
include "/etc/nftables/ruleset-migrated-from-ip6tables.nft"
```

5. Stop and disable the **iptables** service:

```
# systemctl disable --now iptables
```

If you used a custom script to load the **iptables** rules, ensure that the script no longer starts automatically and reboot to flush all tables.

6. Enable and start the **nftables** service:

```
# systemctl enable --now nftables
```

### Verification

- Display the **nftables** rule set:

```
# nft list ruleset
```

### Additional resources

- [Automatically loading nftables rules when the system boots](#)

### 41.1.3. Converting single iptables and ip6tables rules to nftables

Red Hat Enterprise Linux provides the **iptables-translate** and **ip6tables-translate** utilities to convert an **iptables** or **ip6tables** rule into the equivalent one for **nftables**.

#### Prerequisites

- The **nftables** package is installed.

#### Procedure

- Use the **iptables-translate** or **ip6tables-translate** utility instead of **iptables** or **ip6tables** to display the corresponding **nftables** rule, for example:

```
# iptables-translate -A INPUT -s 192.0.2.0/24 -j ACCEPT
nft add rule ip filter INPUT ip saddr 192.0.2.0/24 counter accept
```

Note that some extensions lack translation support. In these cases, the utility prints the untranslated rule prefixed with the **#** sign, for example:

```
# iptables-translate -A INPUT -j CHECKSUM --checksum-fill
nft # -A INPUT -j CHECKSUM --checksum-fill
```

#### Additional resources

- **iptables-translate --help**

### 41.1.4. Comparison of common iptables and nftables commands

The following is a comparison of common **iptables** and **nftables** commands:

- Listing all rules:

iptables	nftables
<b>iptables-save</b>	<b>nft list ruleset</b>

- Listing a certain table and chain:

iptables	nftables
<b>iptables -L</b>	<b>nft list table ip filter</b>
<b>iptables -L INPUT</b>	<b>nft list chain ip filter INPUT</b>
<b>iptables -t nat -L PREROUTING</b>	<b>nft list chain ip nat PREROUTING</b>

The **nft** command does not pre-create tables and chains. They exist only if a user created them manually.

Listing rules generated by firewalld:

-

```
# nft list table inet firewalld
# nft list table ip firewalld
# nft list table ip6 firewalld
```

## 41.2. WRITING AND EXECUTING NFTABLES SCRIPTS

The major benefit of using the **nftables** framework is that the execution of scripts is atomic. This means that the system either applies the whole script or prevents the execution if an error occurs. This guarantees that the firewall is always in a consistent state.

Additionally, with the **nftables** script environment, you can:

- Add comments
- Define variables
- Include other rule-set files

When you install the **nftables** package, Red Hat Enterprise Linux automatically creates **\*.nft** scripts in the **/etc/nftables/** directory. These scripts contain commands that create tables and empty chains for different purposes.

### 41.2.1. Supported nftables script formats

You can write scripts in the **nftables** scripting environment in the following formats:

- The same format as the **nft list ruleset** command displays the rule set:

```
#!/usr/sbin/nft -f

# Flush the rule set
flush ruleset

table inet example_table {
  chain example_chain {
    # Chain for incoming packets that drops all packets that
    # are not explicitly allowed by any rule in this chain
    type filter hook input priority 0; policy drop;

    # Accept connections to port 22 (ssh)
    tcp dport ssh accept
  }
}
```

- The same syntax as for **nft** commands:

```
#!/usr/sbin/nft -f

# Flush the rule set
flush ruleset

# Create a table
add table inet example_table

# Create a chain for incoming packets that drops all packets
```

```
# that are not explicitly allowed by any rule in this chain
add chain inet example_table example_chain { type filter hook input priority 0 ; policy drop ; }

# Add a rule that accepts connections to port 22 (ssh)
add rule inet example_table example_chain tcp dport ssh accept
```

### 41.2.2. Running nftables scripts

You can run an **nftables** script either by passing it to the **nft** utility or by executing the script directly.

#### Procedure

- To run an **nftables** script by passing it to the **nft** utility, enter:

```
# nft -f /etc/nftables/<example_firewall_script>.nft
```

- To run an **nftables** script directly:
  - For the single time that you perform this:
    - Ensure that the script starts with the following shebang sequence:

```
#!/usr/sbin/nft -f
```



#### IMPORTANT

If you omit the **-f** parameter, the **nft** utility does not read the script and displays: **Error: syntax error, unexpected newline, expecting string.**

- Optional: Set the owner of the script to **root**:

```
# chown root /etc/nftables/<example_firewall_script>.nft
```

- Make the script executable for the owner:

```
# chmod u+x /etc/nftables/<example_firewall_script>.nft
```

- Run the script:

```
# /etc/nftables/<example_firewall_script>.nft
```

If no output is displayed, the system executed the script successfully.



#### IMPORTANT

Even if **nft** executes the script successfully, incorrectly placed rules, missing parameters, or other problems in the script can cause that the firewall behaves not as expected.

#### Additional resources

- chown(1)** man page

- **chmod(1)** man page
- [Automatically loading nftables rules when the system boots](#)

### 41.2.3. Using comments in nftables scripts

The **nftables** scripting environment interprets everything to the right of a **#** character to the end of a line as a comment.

Comments can start at the beginning of a line, or next to a command:

```
...
# Flush the rule set
flush ruleset

add table inet example_table # Create a table
...
```

### 41.2.4. Using variables in nftables script

To define a variable in an **nftables** script, use the **define** keyword. You can store single values and anonymous sets in a variable. For more complex scenarios, use sets or verdict maps.

#### Variables with a single value

The following example defines a variable named **INET\_DEV** with the value **enp1s0**:

```
define INET_DEV = enp1s0
```

You can use the variable in the script by entering the **\$** sign followed by the variable name:

```
...
add rule inet example_table example_chain iifname $INET_DEV tcp dport ssh accept
...
```

#### Variables that contain an anonymous set

The following example defines a variable that contains an anonymous set:

```
define DNS_SERVERS = { 192.0.2.1, 192.0.2.2 }
```

You can use the variable in the script by writing the **\$** sign followed by the variable name:

```
add rule inet example_table example_chain ip daddr $DNS_SERVERS accept
```



#### NOTE

Curly braces have special semantics when you use them in a rule because they indicate that the variable represents a set.

#### Additional resources

- [Using sets in nftables commands](#)
- [Using verdict maps in nftables commands](#)

### 41.2.5. Including files in nftables scripts

In the **nftables** scripting environment, you can include other scripts by using the **include** statement.

If you specify only a file name without an absolute or relative path, **nftables** includes files from the default search path, which is set to **/etc** on Red Hat Enterprise Linux.

#### Example 41.1. Including files from the default search directory

To include a file from the default search directory:

```
include "example.nft"
```

#### Example 41.2. Including all \*.nft files from a directory

To include all files ending with **\*.nft** that are stored in the **/etc/nftables/rulesets/** directory:

```
include "/etc/nftables/rulesets/*.nft"
```

Note that the **include** statement does not match files beginning with a dot.

#### Additional resources

- The **Include files** section in the **nft(8)** man page

### 41.2.6. Automatically loading nftables rules when the system boots

The **nftables** systemd service loads firewall scripts that are included in the **/etc/sysconfig/nftables.conf** file.

#### Prerequisites

- The **nftables** scripts are stored in the **/etc/nftables/** directory.

#### Procedure

1. Edit the **/etc/sysconfig/nftables.conf** file.
  - If you modified the **\*.nft** scripts that were created in **/etc/nftables/** with the installation of the **nftables** package, uncomment the **include** statement for these scripts.
  - If you wrote new scripts, add **include** statements to include these scripts. For example, to load the **/etc/nftables/example.nft** script when the **nftables** service starts, add:

```
include "/etc/nftables/_example_.nft"
```

2. Optional: Start the **nftables** service to load the firewall rules without rebooting the system:



```
# systemctl start nftables
```

3. Enable the **nftables** service.

```
# systemctl enable nftables
```

#### Additional resources

- [Supported nftables script formats](#)

## 41.3. CREATING AND MANAGING NFTABLES TABLES, CHAINS, AND RULES

You can display **nftables** rule sets and manage them.

### 41.3.1. Basics of nftables tables

A table in **nftables** is a namespace that contains a collection of chains, rules, sets, and other objects.

Each table must have an address family assigned. The address family defines the packet types that this table processes. You can set one of the following address families when you create a table:

- **ip**: Matches only IPv4 packets. This is the default if you do not specify an address family.
- **ip6**: Matches only IPv6 packets.
- **inet**: Matches both IPv4 and IPv6 packets.
- **arp**: Matches IPv4 address resolution protocol (ARP) packets.
- **bridge**: Matches packets that pass through a bridge device.
- **netdev**: Matches packets from ingress.

If you want to add a table, the format to use depends on your firewall script:

- In scripts in native syntax, use:

```
table <table_address_family> <table_name> {
}
```

- In shell scripts, use:

```
nft add table <table_address_family> <table_name>
```

### 41.3.2. Basics of nftables chains

Tables consist of chains which in turn are containers for rules. The following two rule types exist:

- **Base chain**: You can use base chains as an entry point for packets from the networking stack.
- **Regular chain**: You can use regular chains as a **jump** target to better organize rules.

If you want to add a base chain to a table, the format to use depends on your firewall script:

- In scripts in native syntax, use:

```
table <table_address_family> <table_name> {
  chain <chain_name> {
    type <type> hook <hook> priority <priority>
    policy <policy> ;
  }
}
```

- In shell scripts, use:

```
nft add chain <table_address_family> <table_name> <chain_name> { type <type> hook
<hook> priority <priority> \; policy <policy> \; }
```

To avoid that the shell interprets the semicolons as the end of the command, place the `\` escape character in front of the semicolons.

Both examples create **base chains**. To create a **regular chain**, do not set any parameters in the curly brackets.

### Chain types

The following are the chain types and an overview with which address families and hooks you can use them:

Type	Address families	Hooks	Description
<b>filter</b>	all	all	Standard chain type
<b>nat</b>	<b>ip, ip6, inet</b>	<b>prerouting, input, output, postrouting</b>	Chains of this type perform native address translation based on connection tracking entries. Only the first packet traverses this chain type.
<b>route</b>	<b>ip, ip6</b>	<b>output</b>	Accepted packets that traverse this chain type cause a new route lookup if relevant parts of the IP header have changed.

### Chain priorities

The priority parameter specifies the order in which packets traverse chains with the same hook value. You can set this parameter to an integer value or use a standard priority name.

The following matrix is an overview of the standard priority names and their numeric values, and with which address families and hooks you can use them:

Textual value	Numeric value	Address families	Hooks
<b>raw</b>	<b>-300</b>	<b>ip, ip6, inet</b>	all
<b>mangle</b>	<b>-150</b>	<b>ip, ip6, inet</b>	all

Textual value	Numeric value	Address families	Hooks
<b>dstnat</b>	<b>-100</b>	<b>ip, ip6, inet</b>	<b>prerouting</b>
	<b>-300</b>	<b>bridge</b>	<b>prerouting</b>
<b>filter</b>	<b>0</b>	<b>ip, ip6, inet, arp, netdev</b>	all
	<b>-200</b>	<b>bridge</b>	all
<b>security</b>	<b>50</b>	<b>ip, ip6, inet</b>	all
<b>srcnat</b>	<b>100</b>	<b>ip, ip6, inet</b>	<b>postrouting</b>
	<b>300</b>	<b>bridge</b>	<b>postrouting</b>
<b>out</b>	<b>100</b>	<b>bridge</b>	<b>output</b>

### Chain policies

The chain policy defines whether **nftables** should accept or drop packets if rules in this chain do not specify any action. You can set one of the following policies in a chain:

- **accept** (default)
- **drop**

### 41.3.3. Basics of nftables rules

Rules define actions to perform on packets that pass a chain that contains this rule. If the rule also contains matching expressions, **nftables** performs the actions only if all previous expressions apply.

If you want to add a rule to a chain, the format to use depends on your firewall script:

- In scripts in native syntax, use:

```
table <table_address_family> <table_name> {
  chain <chain_name> {
    type <type> hook <hook> priority <priority> ; policy <policy> ;
    <rule>
  }
}
```

- In shell scripts, use:

```
nft add rule <table_address_family> <table_name> <chain_name> <rule>
```

This shell command appends the new rule at the end of the chain. If you prefer to add a rule at the beginning of the chain, use the **nft insert** command instead of **nft add**.

### 41.3.4. Managing tables, chains, and rules using nft commands

To manage an **nftables** firewall on the command line or in shell scripts, use the **nft** utility.



## IMPORTANT

The commands in this procedure do not represent a typical workflow and are not optimized. This procedure only demonstrates how to use **nft** commands to manage tables, chains, and rules in general.

### Procedure

1. Create a table named **nftables\_svc** with the **inet** address family so that the table can process both IPv4 and IPv6 packets:

```
# nft add table inet nftables_svc
```

2. Add a base chain named **INPUT**, that processes incoming network traffic, to the **inet nftables\_svc** table:

```
# nft add chain inet nftables_svc INPUT { type filter hook input priority filter; policy accept; }
```

To avoid that the shell interprets the semicolons as the end of the command, escape the semicolons using the `\` character.

3. Add rules to the **INPUT** chain. For example, allow incoming TCP traffic on port 22 and 443, and, as the last rule of the **INPUT** chain, reject other incoming traffic with an Internet Control Message Protocol (ICMP) port unreachable message:

```
# nft add rule inet nftables_svc INPUT tcp dport 22 accept
# nft add rule inet nftables_svc INPUT tcp dport 443 accept
# nft add rule inet nftables_svc INPUT reject with icmpx type port-unreachable
```

If you enter the **nft add rule** commands as shown, **nft** adds the rules in the same order to the chain as you run the commands.

4. Display the current rule set including handles:

```
# nft -a list table inet nftables_svc
table inet nftables_svc { # handle 13
  chain INPUT { # handle 1
    type filter hook input priority filter; policy accept;
    tcp dport 22 accept # handle 2
    tcp dport 443 accept # handle 3
    reject # handle 4
  }
}
```

5. Insert a rule before the existing rule with handle 3. For example, to insert a rule that allows TCP traffic on port 636, enter:

```
# nft insert rule inet nftables_svc INPUT position 3 tcp dport 636 accept
```

6. Append a rule after the existing rule with handle 3. For example, to insert a rule that allows TCP traffic on port 80, enter:

```
# nft add rule inet nftables_svc INPUT position 3 tcp dport 80 accept
```

7. Display the rule set again with handles. Verify that the later added rules have been added to the specified positions:

```
# nft -a list table inet nftables_svc
table inet nftables_svc { # handle 13
  chain INPUT { # handle 1
    type filter hook input priority filter; policy accept;
    tcp dport 22 accept # handle 2
    tcp dport 636 accept # handle 5
    tcp dport 443 accept # handle 3
    tcp dport 80 accept # handle 6
    reject # handle 4
  }
}
```

8. Remove the rule with handle 6:

```
# nft delete rule inet nftables_svc INPUT handle 6
```

To remove a rule, you must specify the handle.

9. Display the rule set, and verify that the removed rule is no longer present:

```
# nft -a list table inet nftables_svc
table inet nftables_svc { # handle 13
  chain INPUT { # handle 1
    type filter hook input priority filter; policy accept;
    tcp dport 22 accept # handle 2
    tcp dport 636 accept # handle 5
    tcp dport 443 accept # handle 3
    reject # handle 4
  }
}
```

10. Remove all remaining rules from the **INPUT** chain:

```
# nft flush chain inet nftables_svc INPUT
```

11. Display the rule set, and verify that the **INPUT** chain is empty:

```
# nft list table inet nftables_svc
table inet nftables_svc {
  chain INPUT {
    type filter hook input priority filter; policy accept
  }
}
```

12. Delete the **INPUT** chain:

```
# nft delete chain inet nftables_svc INPUT
```

You can also use this command to delete chains that still contain rules.

13. Display the rule set, and verify that the **INPUT** chain has been deleted:

```
# nft list table inet nftables_svc
table inet nftables_svc {
}
```

14. Delete the **nftables\_svc** table:

```
# nft delete table inet nftables_svc
```

You can also use this command to delete tables that still contain chains.

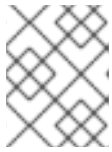

#### NOTE

To delete the entire rule set, use the **nft flush ruleset** command instead of manually deleting all rules, chains, and tables in separate commands.

#### Additional resources

**nft(8)** man page

## 41.4. CONFIGURING NAT USING NFTABLES

With **nftables**, you can configure the following network address translation (NAT) types:

- Masquerading
- Source NAT (SNAT)
- Destination NAT (DNAT)
- Redirect



#### IMPORTANT

You can only use real interface names in **iifname** and **oifname** parameters, and alternative names (**altname**) are not supported.

### 41.4.1. NAT types

These are the different network address translation (NAT) types:

#### Masquerading and source NAT (SNAT)

Use one of these NAT types to change the source IP address of packets. For example, Internet Service Providers (ISPs) do not route private IP ranges, such as **10.0.0.0/8**. If you use private IP ranges in your network and users should be able to reach servers on the internet, map the source IP address of packets from these ranges to a public IP address.

Masquerading and SNAT are very similar to one another. The differences are:

- Masquerading automatically uses the IP address of the outgoing interface. Therefore, use masquerading if the outgoing interface uses a dynamic IP address.

- SNAT sets the source IP address of packets to a specified IP and does not dynamically look up the IP of the outgoing interface. Therefore, SNAT is faster than masquerading. Use SNAT if the outgoing interface uses a fixed IP address.

### Destination NAT (DNAT)

Use this NAT type to rewrite the destination address and port of incoming packets. For example, if your web server uses an IP address from a private IP range and is, therefore, not directly accessible from the internet, you can set a DNAT rule on the router to redirect incoming traffic to this server.

### Redirect

This type is a special case of DNAT that redirects packets to the local machine depending on the chain hook. For example, if a service runs on a different port than its standard port, you can redirect incoming traffic from the standard port to this specific port.

## 41.4.2. Configuring masquerading using nftables

Masquerading enables a router to dynamically change the source IP of packets sent through an interface to the IP address of the interface. This means that if the interface gets a new IP assigned, **nftables** automatically uses the new IP when replacing the source IP.

Replace the source IP of packets leaving the host through the **ens3** interface to the IP set on **ens3**.

### Procedure

1. Create a table:

```
# nft add table nat
```

2. Add the **prerouting** and **postrouting** chains to the table:

```
# nft add chain nat postrouting { type nat hook postrouting priority 100 \; }
```



### IMPORTANT

Even if you do not add a rule to the **prerouting** chain, the **nftables** framework requires this chain to match incoming packet replies.

Note that you must pass the **--** option to the **nft** command to prevent the shell from interpreting the negative priority value as an option of the **nft** command.

3. Add a rule to the **postrouting** chain that matches outgoing packets on the **ens3** interface:

```
# nft add rule nat postrouting oifname "ens3" masquerade
```

## 41.4.3. Configuring source NAT using nftables

On a router, Source NAT (SNAT) enables you to change the IP of packets sent through an interface to a specific IP address. The router then replaces the source IP of outgoing packets.

### Procedure

1. Create a table:



```
# nft add table nat
```

2. Add the **prerouting** and **postrouting** chains to the table:

```
# nft add chain nat postrouting { type nat hook postrouting priority 100 \; }
```



### IMPORTANT

Even if you do not add a rule to the **postrouting** chain, the **nftables** framework requires this chain to match outgoing packet replies.

Note that you must pass the **--** option to the **nft** command to prevent the shell from interpreting the negative priority value as an option of the **nft** command.

3. Add a rule to the **postrouting** chain that replaces the source IP of outgoing packets through **ens3** with **192.0.2.1**:

```
# nft add rule nat postrouting oifname "ens3" snat to 192.0.2.1
```

### Additional resources

- [Forwarding incoming packets on a specific local port to a different host](#)

## 41.4.4. Configuring destination NAT using nftables

Destination NAT (DNAT) enables you to redirect traffic on a router to a host that is not directly accessible from the internet.

For example, with DNAT the router redirects incoming traffic sent to port **80** and **443** to a web server with the IP address **192.0.2.1**.

### Procedure

1. Create a table:

```
# nft add table nat
```

2. Add the **prerouting** and **postrouting** chains to the table:

```
# nft -- add chain nat prerouting { type nat hook prerouting priority -100 \; }
# nft add chain nat postrouting { type nat hook postrouting priority 100 \; }
```

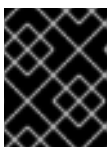

### IMPORTANT

Even if you do not add a rule to the **postrouting** chain, the **nftables** framework requires this chain to match outgoing packet replies.

Note that you must pass the **--** option to the **nft** command to prevent the shell from interpreting the negative priority value as an option of the **nft** command.

3. Add a rule to the **prerouting** chain that redirects incoming traffic to port **80** and **443** on the **ens3** interface of the router to the web server with the IP address **192.0.2.1**:



```
# nft add rule nat prerouting iifname ens3 tcp dport { 80, 443 } dnat to 192.0.2.1
```

4. Depending on your environment, add either a SNAT or masquerading rule to change the source address for packets returning from the web server to the sender:

- a. If the **ens3** interface uses a dynamic IP addresses, add a masquerading rule:

```
# nft add rule nat postrouting oifname "ens3" masquerade
```

- b. If the **ens3** interface uses a static IP address, add a SNAT rule. For example, if the **ens3** uses the **198.51.100.1** IP address:

```
# nft add rule nat postrouting oifname "ens3" snat to 198.51.100.1
```

5. Enable packet forwarding:

```
# echo "net.ipv4.ip_forward=1" > /etc/sysctl.d/95-IPv4-forwarding.conf
# sysctl -p /etc/sysctl.d/95-IPv4-forwarding.conf
```

#### Additional resources

- [NAT types](#)

#### 41.4.5. Configuring a redirect using nftables

The **redirect** feature is a special case of destination network address translation (DNAT) that redirects packets to the local machine depending on the chain hook.

For example, you can redirect incoming and forwarded traffic sent to port **22** of the local host to port **2222**.

#### Procedure

1. Create a table:

```
# nft add table nat
```

2. Add the **prerouting** chain to the table:

```
# nft -- add chain nat prerouting { type nat hook prerouting priority -100 \; }
```

Note that you must pass the **--** option to the **nft** command to prevent the shell from interpreting the negative priority value as an option of the **nft** command.

3. Add a rule to the **prerouting** chain that redirects incoming traffic on port **22** to port **2222**:

```
# nft add rule nat prerouting tcp dport 22 redirect to 2222
```

#### Additional resources

- [NAT types](#)

## 41.4.6. Configuring flowtable by using nftables

The **nftables** utility uses the **netfilter** framework to provide network address translation (NAT) for network traffic and provides the fastpath feature-based **flowtable** mechanism to accelerate packet forwarding.

The flowtable mechanism has the following features:

- Uses connection tracking to bypass the classic packet forwarding path.
- Avoids revisiting the routing table by bypassing the classic packet processing.
- Works only with TCP and UDP protocols.
- Hardware independent software fast path.

### Procedure

1. Add an **example-table** table of **inet** family:

```
# nft add table inet <example-table>
```

2. Add an **example-flowtable** flowtable with **ingress** hook and **filter** as a priority type:

```
# nft add flowtable inet <example-table> <example-flowtable> { hook ingress priority filter \; devices = { enp1s0, enp7s0 } \; }
```

3. Add an **example-forwardchain** flow to the flowtable from a packet processing table:

```
# nft add chain inet <example-table> <example-forwardchain> { type filter hook forward priority filter \; }
```

This command adds a flowtable of **filter** type with **forward** hook and **filter** priority.

4. Add a rule with **established** connection tracking state to offload **example-flowtable** flow:

```
# nft add rule inet <example-table> <example-forwardchain> ct state established flow add @<example-flowtable>
```

### Verification

- Verify the properties of **example-table**:

```
# nft list table inet <example-table>
table inet example-table {
    flowtable example-flowtable {
        hook ingress priority filter
        devices = { enp1s0, enp7s0 }
    }

    chain example-forwardchain {
        type filter hook forward priority filter; policy accept;
    }
}
```

```

ct state established flow add @example-flowtable
}
}

```

### Additional resources

- **nft(8)** man page

## 41.5. USING SETS IN NFTABLES COMMANDS

The **nftables** framework natively supports sets. You can use sets, for example, if a rule should match multiple IP addresses, port numbers, interfaces, or any other match criteria.

### 41.5.1. Using anonymous sets in nftables

An anonymous set contains comma-separated values enclosed in curly brackets, such as **{ 22, 80, 443 }**, that you use directly in a rule. You can use anonymous sets also for IP addresses and any other match criteria.

The drawback of anonymous sets is that if you want to change the set, you must replace the rule. For a dynamic solution, use named sets as described in [Using named sets in nftables](#).

### Prerequisites

- The **example\_chain** chain and the **example\_table** table in the **inet** family exists.

### Procedure

1. For example, to add a rule to **example\_chain** in **example\_table** that allows incoming traffic to port **22, 80, and 443**:

```
# nft add rule inet example_table example_chain tcp dport { 22, 80, 443 } accept
```

2. Optional: Display all chains and their rules in **example\_table**:

```
# nft list table inet example_table
table inet example_table {
  chain example_chain {
    type filter hook input priority filter; policy accept;
    tcp dport { ssh, http, https } accept
  }
}
```

### 41.5.2. Using named sets in nftables

The **nftables** framework supports mutable named sets. A named set is a list or range of elements that you can use in multiple rules within a table. Another benefit over anonymous sets is that you can update a named set without replacing the rules that use the set.

When you create a named set, you must specify the type of elements the set contains. You can set the following types:

- **ipv4\_addr** for a set that contains IPv4 addresses or ranges, such as **192.0.2.1** or **192.0.2.0/24**.

- **ipv6\_addr** for a set that contains IPv6 addresses or ranges, such as **2001:db8:1::1** or **2001:db8:1::1/64**.
- **ether\_addr** for a set that contains a list of media access control (MAC) addresses, such as **52:54:00:6b:66:42**.
- **inet\_proto** for a set that contains a list of internet protocol types, such as **tcp**.
- **inet\_service** for a set that contains a list of internet services, such as **ssh**.
- **mark** for a set that contains a list of packet marks. Packet marks can be any positive 32-bit integer value (**0** to **2147483647**).

### Prerequisites

- The **example\_chain** chain and the **example\_table** table exists.

### Procedure

1. Create an empty set. The following examples create a set for IPv4 addresses:

- To create a set that can store multiple individual IPv4 addresses:

```
# nft add set inet example_table example_set { type ipv4_addr \;
```

- To create a set that can store IPv4 address ranges:

```
# nft add set inet example_table example_set { type ipv4_addr \; flags interval \;
```

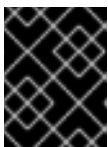

#### IMPORTANT

To prevent the shell from interpreting the semicolons as the end of the command, you must escape the semicolons with a backslash.

2. Optional: Create rules that use the set. For example, the following command adds a rule to the **example\_chain** in the **example\_table** that will drop all packets from IPv4 addresses in **example\_set**.

```
# nft add rule inet example_table example_chain ip saddr @example_set drop
```

Because **example\_set** is still empty, the rule has currently no effect.

3. Add IPv4 addresses to **example\_set**:

- If you create a set that stores individual IPv4 addresses, enter:

```
# nft add element inet example_table example_set { 192.0.2.1, 192.0.2.2 }
```

- If you create a set that stores IPv4 ranges, enter:

```
# nft add element inet example_table example_set { 192.0.2.0-192.0.2.255 }
```

When you specify an IP address range, you can alternatively use the Classless Inter-Domain Routing (CIDR) notation, such as **192.0.2.0/24** in the above example.

### 41.5.3. Additional resources

- The **Sets** section in the **nft(8)** man page

## 41.6. USING VERDICT MAPS IN NFTABLES COMMANDS

Verdict maps, which are also known as dictionaries, enable **nft** to perform an action based on packet information by mapping match criteria to an action.

### 41.6.1. Using anonymous maps in nftables

An anonymous map is a **{ match\_criteria : action }** statement that you use directly in a rule. The statement can contain multiple comma-separated mappings.

The drawback of an anonymous map is that if you want to change the map, you must replace the rule. For a dynamic solution, use named maps as described in [Using named maps in nftables](#).

For example, you can use an anonymous map to route both TCP and UDP packets of the IPv4 and IPv6 protocol to different chains to count incoming TCP and UDP packets separately.

#### Procedure

1. Create a new table:

```
# nft add table inet example_table
```

2. Create the **tcp\_packets** chain in **example\_table**:

```
# nft add chain inet example_table tcp_packets
```

3. Add a rule to **tcp\_packets** that counts the traffic in this chain:

```
# nft add rule inet example_table tcp_packets counter
```

4. Create the **udp\_packets** chain in **example\_table**

```
# nft add chain inet example_table udp_packets
```

5. Add a rule to **udp\_packets** that counts the traffic in this chain:

```
# nft add rule inet example_table udp_packets counter
```

6. Create a chain for incoming traffic. For example, to create a chain named **incoming\_traffic** in **example\_table** that filters incoming traffic:

```
# nft add chain inet example_table incoming_traffic { type filter hook input priority 0 \;  
}
```

7. Add a rule with an anonymous map to **incoming\_traffic**:

```
# nft add rule inet example_table incoming_traffic ip protocol vmap { tcp : jump  
tcp_packets, udp : jump udp_packets }
```

The anonymous map distinguishes the packets and sends them to the different counter chains based on their protocol.

- To list the traffic counters, display **example\_table**:

```
# nft list table inet example_table
table inet example_table {
  chain tcp_packets {
    counter packets 36379 bytes 2103816
  }

  chain udp_packets {
    counter packets 10 bytes 1559
  }

  chain incoming_traffic {
    type filter hook input priority filter; policy accept;
    ip protocol vmap { tcp : jump tcp_packets, udp : jump udp_packets }
  }
}
```

The counters in the **tcp\_packets** and **udp\_packets** chain display both the number of received packets and bytes.

### 41.6.2. Using named maps in nftables

The **nftables** framework supports named maps. You can use these maps in multiple rules within a table. Another benefit over anonymous maps is that you can update a named map without replacing the rules that use it.

When you create a named map, you must specify the type of elements:

- **ipv4\_addr** for a map whose match part contains an IPv4 address, such as **192.0.2.1**.
- **ipv6\_addr** for a map whose match part contains an IPv6 address, such as **2001:db8:1::1**.
- **ether\_addr** for a map whose match part contains a media access control (MAC) address, such as **52:54:00:6b:66:42**.
- **inet\_proto** for a map whose match part contains an internet protocol type, such as **tcp**.
- **inet\_service** for a map whose match part contains an internet services name port number, such as **ssh** or **22**.
- **mark** for a map whose match part contains a packet mark. A packet mark can be any positive 32-bit integer value (**0** to **2147483647**).
- **counter** for a map whose match part contains a counter value. The counter value can be any positive 64-bit integer value.
- **quota** for a map whose match part contains a quota value. The quota value can be any positive 64-bit integer value.

For example, you can allow or drop incoming packets based on their source IP address. Using a named map, you require only a single rule to configure this scenario while the IP addresses and actions are dynamically stored in the map.

## Procedure

1. Create a table. For example, to create a table named **example\_table** that processes IPv4 packets:

```
# nft add table ip example_table
```

2. Create a chain. For example, to create a chain named **example\_chain** in **example\_table**:

```
# nft add chain ip example_table example_chain { type filter hook input priority 0 \; }
```



### IMPORTANT

To prevent the shell from interpreting the semicolons as the end of the command, you must escape the semicolons with a backslash.

3. Create an empty map. For example, to create a map for IPv4 addresses:

```
# nft add map ip example_table example_map { type ipv4_addr : verdict \; }
```

4. Create rules that use the map. For example, the following command adds a rule to **example\_chain** in **example\_table** that applies actions to IPv4 addresses which are both defined in **example\_map**:

```
# nft add rule example_table example_chain ip saddr vmap @example_map
```

5. Add IPv4 addresses and corresponding actions to **example\_map**:

```
# nft add element ip example_table example_map { 192.0.2.1 : accept, 192.0.2.2 : drop }
```

This example defines the mappings of IPv4 addresses to actions. In combination with the rule created above, the firewall accepts packet from **192.0.2.1** and drops packets from **192.0.2.2**.

6. Optional: Enhance the map by adding another IP address and action statement:

```
# nft add element ip example_table example_map { 192.0.2.3 : accept }
```

7. Optional: Remove an entry from the map:

```
# nft delete element ip example_table example_map { 192.0.2.1 }
```

8. Optional: Display the rule set:

```
# nft list ruleset
table ip example_table {
  map example_map {
    type ipv4_addr : verdict
    elements = { 192.0.2.2 : drop, 192.0.2.3 : accept }
  }

  chain example_chain {
    type filter hook input priority filter; policy accept;
  }
}
```

```
ip saddr vmap @example_map
}
}
```

### 41.6.3. Additional resources

- The **Maps** section in the **nft(8)** man page

## 41.7. EXAMPLE: PROTECTING A LAN AND DMZ USING AN NFTABLES SCRIPT

Use the **nftables** framework on a RHEL router to write and install a firewall script that protects the network clients in an internal LAN and a web server in a DMZ from unauthorized access from the internet and from other networks.



### IMPORTANT

This example is only for demonstration purposes and describes a scenario with specific requirements.

Firewall scripts highly depend on the network infrastructure and security requirements. Use this example to learn the concepts of **nftables** firewalls when you write scripts for your own environment.

### 41.7.1. Network conditions

The network in this example has the following conditions:

- The router is connected to the following networks:
  - The internet through interface **enp1s0**
  - The internal LAN through interface **enp7s0**
  - The DMZ through **enp8s0**
- The internet interface of the router has both a static IPv4 address (**203.0.113.1**) and IPv6 address (**2001:db8:a::1**) assigned.
- The clients in the internal LAN use only private IPv4 addresses from the range **10.0.0.0/24**. Consequently, traffic from the LAN to the internet requires source network address translation (SNAT).
- The administrator PCs in the internal LAN use the IP addresses **10.0.0.100** and **10.0.0.200**.
- The DMZ uses public IP addresses from the ranges **198.51.100.0/24** and **2001:db8:b::/56**.
- The web server in the DMZ uses the IP addresses **198.51.100.5** and **2001:db8:b::5**.
- The router acts as a caching DNS server for hosts in the LAN and DMZ.

### 41.7.2. Security requirements to the firewall script

The following are the requirements to the **nftables** firewall in the example network:



- The router must be able to:
  - Recursively resolve DNS queries.
  - Perform all connections on the loopback interface.
- Clients in the internal LAN must be able to:
  - Query the caching DNS server running on the router.
  - Access the HTTPS server in the DMZ.
  - Access any HTTPS server on the internet.
- The PCs of the administrators must be able to access the router and every server in the DMZ using SSH.
- The web server in the DMZ must be able to:
  - Query the caching DNS server running on the router.
  - Access HTTPS servers on the internet to download updates.
- Hosts on the internet must be able to:
  - Access the HTTPS servers in the DMZ.
- Additionally, the following security requirements exist:
  - Connection attempts that are not explicitly allowed should be dropped.
  - Dropped packets should be logged.

### 41.7.3. Configuring logging of dropped packets to a file

By default, **systemd** logs kernel messages, such as for dropped packets, to the journal. Additionally, you can configure the **rsyslog** service to log such entries to a separate file. To ensure that the log file does not grow infinitely, configure a rotation policy.

#### Prerequisites

- The **rsyslog** package is installed.
- The **rsyslog** service is running.

#### Procedure

1. Create the **/etc/rsyslog.d/nftables.conf** file with the following content:

```

:msg, startswith, "nft drop" -/var/log/nftables.log
& stop

```

Using this configuration, the **rsyslog** service logs dropped packets to the **/var/log/nftables.log** file instead of **/var/log/messages**.

2. Restart the **rsyslog** service:

**# systemctl restart rsyslog**

3. Create the `/etc/logrotate.d/nftables` file with the following content to rotate `/var/log/nftables.log` if the size exceeds 10 MB:

```
/var/log/nftables.log {
    size +10M
    maxage 30
    sharedscripts
    postrotate
        /usr/bin/systemctl kill -s HUP rsyslog.service >/dev/null 2>&1 || true
    endscript
}
```

The **maxage 30** setting defines that **logrotate** removes rotated logs older than 30 days during the next rotation operation.

**Additional resources**

- **rsyslog.conf(5)** man page
- **logrotate(8)** man page

**41.7.4. Writing and activating the nftables script**

This example is an **nftables** firewall script that runs on a RHEL router and protects the clients in an internal LAN and a web server in a DMZ. For details about the network and the requirements for the firewall used in the example, see [Network conditions](#) and [Security requirements to the firewall script](#).

**WARNING**

This **nftables** firewall script is only for demonstration purposes. Do not use it without adapting it to your environments and security requirements.

**Prerequisites**

- The network is configured as described in [Network conditions](#).

**Procedure**

1. Create the `/etc/nftables/firewall.nft` script with the following content:

```
# Remove all rules
flush ruleset

# Table for both IPv4 and IPv6 rules
table inet nftables_svc {
```

```

# Define variables for the interface name
define INET_DEV = enp1s0
define LAN_DEV = enp7s0
define DMZ_DEV = enp8s0

# Set with the IPv4 addresses of admin PCs
set admin_pc_ipv4 {
    type ipv4_addr
    elements = { 10.0.0.100, 10.0.0.200 }
}

# Chain for incoming traffic. Default policy: drop
chain INPUT {
    type filter hook input priority filter
    policy drop

    # Accept packets in established and related state, drop invalid packets
    ct state vmap { established:accept, related:accept, invalid:drop }

    # Accept incoming traffic on loopback interface
    iifname lo accept

    # Allow request from LAN and DMZ to local DNS server
    iifname { $LAN_DEV, $DMZ_DEV } meta l4proto { tcp, udp } th dport 53 accept

    # Allow admins PCs to access the router using SSH
    iifname $LAN_DEV ip saddr @admin_pc_ipv4 tcp dport 22 accept

    # Last action: Log blocked packets
    # (packets that were not accepted in previous rules in this chain)
    log prefix "nft drop IN : "
}

# Chain for outgoing traffic. Default policy: drop
chain OUTPUT {
    type filter hook output priority filter
    policy drop

    # Accept packets in established and related state, drop invalid packets
    ct state vmap { established:accept, related:accept, invalid:drop }

    # Accept outgoing traffic on loopback interface
    oifname lo accept

    # Allow local DNS server to recursively resolve queries
    oifname $INET_DEV meta l4proto { tcp, udp } th dport 53 accept

    # Last action: Log blocked packets
    log prefix "nft drop OUT: "
}

# Chain for forwarding traffic. Default policy: drop

```

```

chain FORWARD {
    type filter hook forward priority filter
    policy drop

    # Accept packets in established and related state, drop invalid packets
    ct state vmap { established:accept, related:accept, invalid:drop }

    # IPv4 access from LAN and internet to the HTTPS server in the DMZ
    iifname { $LAN_DEV, $INET_DEV } oifname $DMZ_DEV ip daddr 198.51.100.5 tcp dport
443 accept

    # IPv6 access from internet to the HTTPS server in the DMZ
    iifname $INET_DEV oifname $DMZ_DEV ip6 daddr 2001:db8:b::5 tcp dport 443 accept

    # Access from LAN and DMZ to HTTPS servers on the internet
    iifname { $LAN_DEV, $DMZ_DEV } oifname $INET_DEV tcp dport 443 accept

    # Last action: Log blocked packets
    log prefix "nft drop FWD: "
}

# Postrouting chain to handle SNAT
chain postrouting {
    type nat hook postrouting priority srcnat; policy accept;

    # SNAT for IPv4 traffic from LAN to internet
    iifname $LAN_DEV oifname $INET_DEV snat ip to 203.0.113.1
}
}

```

2. Include the `/etc/nftables/firewall.nft` script in the `/etc/sysconfig/nftables.conf` file:

```
include "/etc/nftables/firewall.nft"
```

3. Enable IPv4 forwarding:

```
# echo "net.ipv4.ip_forward=1" > /etc/sysctl.d/95-IPv4-forwarding.conf
# sysctl -p /etc/sysctl.d/95-IPv4-forwarding.conf
```

4. Enable and start the `nftables` service:

```
# systemctl enable --now nftables
```

## Verification

1. Optional: Verify the `nftables` rule set:

```
# nft list ruleset
...
```

2. Try to perform an access that the firewall prevents. For example, try to access the router using SSH from the DMZ:

```
# ssh router.example.com
ssh: connect to host router.example.com port 22: Network is unreachable
```

3. Depending on your logging settings, search:

- The **systemd** journal for the blocked packets:

```
# journalctl -k -g "nft drop"
Oct 14 17:27:18 router kernel: nft drop IN : IN=enp8s0 OUT= MAC=...
SRC=198.51.100.5 DST=198.51.100.1 ... PROTO=TCP SPT=40464 DPT=22 ... SYN ...
```

- The **/var/log/nftables.log** file for the blocked packets:

```
Oct 14 17:27:18 router kernel: nft drop IN : IN=enp8s0 OUT= MAC=...
SRC=198.51.100.5 DST=198.51.100.1 ... PROTO=TCP SPT=40464 DPT=22 ... SYN ...
```

## 41.8. CONFIGURING PORT FORWARDING USING NFTABLES

Port forwarding enables administrators to forward packets sent to a specific destination port to a different local or remote port.

For example, if your web server does not have a public IP address, you can set a port forwarding rule on your firewall that forwards incoming packets on port **80** and **443** on the firewall to the web server. With this firewall rule, users on the internet can access the web server using the IP or host name of the firewall.

### 41.8.1. Forwarding incoming packets to a different local port

You can use **nftables** to forward packets. For example, you can forward incoming IPv4 packets on port **8022** to port **22** on the local system.

#### Procedure

1. Create a table named **nat** with the **ip** address family:

```
# nft add table ip nat
```

2. Add the **prerouting** and **postrouting** chains to the table:

```
# nft -- add chain ip nat prerouting { type nat hook prerouting priority -100 \; }
```



#### NOTE

Pass the **--** option to the **nft** command to prevent the shell from interpreting the negative priority value as an option of the **nft** command.

3. Add a rule to the **prerouting** chain that redirects incoming packets on port **8022** to the local port **22**:

```
# nft add rule ip nat prerouting tcp dport 8022 redirect to :22
```

## 41.8.2. Forwarding incoming packets on a specific local port to a different host

You can use a destination network address translation (DNAT) rule to forward incoming packets on a local port to a remote host. This enables users on the internet to access a service that runs on a host with a private IP address.

For example, you can forward incoming IPv4 packets on the local port **443** to the same port number on the remote system with the **192.0.2.1** IP address.

### Prerequisites

- You are logged in as the **root** user on the system that should forward the packets.

### Procedure

1. Create a table named **nat** with the **ip** address family:

```
# nft add table ip nat
```

2. Add the **prerouting** and **postrouting** chains to the table:

```
# nft -- add chain ip nat prerouting { type nat hook prerouting priority -100 \; }
# nft add chain ip nat postrouting { type nat hook postrouting priority 100 \; }
```



#### NOTE

Pass the **--** option to the **nft** command to prevent the shell from interpreting the negative priority value as an option of the **nft** command.

3. Add a rule to the **prerouting** chain that redirects incoming packets on port **443** to the same port on **192.0.2.1**:

```
# nft add rule ip nat prerouting tcp dport 443 dnat to 192.0.2.1
```

4. Add a rule to the **postrouting** chain to masquerade outgoing traffic:

```
# nft add rule ip nat postrouting daddr 192.0.2.1 masquerade
```

5. Enable packet forwarding:

```
# echo "net.ipv4.ip_forward=1" > /etc/sysctl.d/95-IPv4-forwarding.conf
# sysctl -p /etc/sysctl.d/95-IPv4-forwarding.conf
```

## 41.9. USING NFTABLES TO LIMIT THE AMOUNT OF CONNECTIONS

You can use **nftables** to limit the number of connections or to block IP addresses that attempt to establish a given amount of connections to prevent them from using too many system resources.

### 41.9.1. Limiting the number of connections using nftables

The **ct count** parameter of the **nft** utility enables administrators to limit the number of connections.

## Prerequisites

- The base **example\_chain** in **example\_table** exists.

## Procedure

1. Create a dynamic set for IPv4 addresses:

```
# nft add set inet example_table example_meter { type ipv4_addr\; flags dynamic \;}
```

2. Add a rule that allows only two simultaneous connections to the SSH port (22) from an IPv4 address and rejects all further connections from the same IP:

```
# nft add rule ip example_table example_chain tcp dport ssh meter example_meter { ip saddr ct count over 2 } counter reject
```

3. Optional: Display the set created in the previous step:

```
# nft list set inet example_table example_meter
table inet example_table {
  meter example_meter {
    type ipv4_addr
    size 65535
    elements = { 192.0.2.1 ct count over 2 , 192.0.2.2 ct count over 2 }
  }
}
```

The **elements** entry displays addresses that currently match the rule. In this example, **elements** lists IP addresses that have active connections to the SSH port. Note that the output does not display the number of active connections or if connections were rejected.

### 41.9.2. Blocking IP addresses that attempt more than ten new incoming TCP connections within one minute

You can temporarily block hosts that are establishing more than ten IPv4 TCP connections within one minute.

## Procedure

1. Create the **filter** table with the **ip** address family:

```
# nft add table ip filter
```

2. Add the **input** chain to the **filter** table:

```
# nft add chain ip filter input { type filter hook input priority 0 \; }
```

3. Add a rule that drops all packets from source addresses that attempt to establish more than ten TCP connections within one minute:

```
# nft add rule ip filter input ip protocol tcp ct state new, untracked meter ratemeter { ip saddr timeout 5m limit rate over 10/minute } drop
```

The **timeout 5m** parameter defines that **nftables** automatically removes entries after five minutes to prevent that the meter fills up with stale entries.

## Verification

- To display the meter's content, enter:

```
# nft list meter ip filter ratemeter
table ip filter {
  meter ratemeter {
    type ipv4_addr
    size 65535
    flags dynamic,timeout
    elements = { 192.0.2.1 limit rate over 10/minute timeout 5m expires 4m58s224ms }
  }
}
```

## 41.10. DEBUGGING NFTABLES RULES

The **nftables** framework provides different options for administrators to debug rules and if packets match them.

### 41.10.1. Creating a rule with a counter

To identify if a rule is matched, you can use a counter.

- For more information about a procedure that adds a counter to an existing rule, see [Adding a counter to an existing rule](#).

#### Prerequisites

- The chain to which you want to add the rule exists.

#### Procedure

1. Add a new rule with the **counter** parameter to the chain. The following example adds a rule with a counter that allows TCP traffic on port 22 and counts the packets and traffic that match this rule:

```
# nft add rule inet example_table example_chain tcp dport 22 counter accept
```

2. To display the counter values:

```
# nft list ruleset
table inet example_table {
  chain example_chain {
    type filter hook input priority filter; policy accept;
    tcp dport ssh counter packets 6872 bytes 105448565 accept
  }
}
```

### 41.10.2. Adding a counter to an existing rule



To identify if a rule is matched, you can use a counter.

- For more information about a procedure that adds a new rule with a counter, see [Creating a rule with the counter](#).

### Prerequisites

- The rule to which you want to add the counter exists.

### Procedure

1. Display the rules in the chain including their handles:

```
# nft --handle list chain inet example_table example_chain
table inet example_table {
  chain example_chain { # handle 1
    type filter hook input priority filter; policy accept;
    tcp dport ssh accept # handle 4
  }
}
```

2. Add the counter by replacing the rule but with the **counter** parameter. The following example replaces the rule displayed in the previous step and adds a counter:

```
# nft replace rule inet example_table example_chain handle 4 tcp dport 22 counter
accept
```

3. To display the counter values:

```
# nft list ruleset
table inet example_table {
  chain example_chain {
    type filter hook input priority filter; policy accept;
    tcp dport ssh counter packets 6872 bytes 105448565 accept
  }
}
```

### 41.10.3. Monitoring packets that match an existing rule

The tracing feature in **nftables** in combination with the **nft monitor** command enables administrators to display packets that match a rule. You can enable tracing for a rule and use it to monitor packets that match this rule.

### Prerequisites

- The rule to which you want to add the counter exists.

### Procedure

1. Display the rules in the chain including their handles:

```
# nft --handle list chain inet example_table example_chain
table inet example_table {
```

```
chain example_chain { # handle 1
    type filter hook input priority filter; policy accept;
    tcp dport ssh accept # handle 4
}
}
```

2. Add the tracing feature by replacing the rule but with the **meta nfttrace set 1** parameters. The following example replaces the rule displayed in the previous step and enables tracing:

```
# nft replace rule inet example_table example_chain handle 4 tcp dport 22 meta nfttrace set 1 accept
```

3. Use the **nft monitor** command to display the tracing. The following example filters the output of the command to display only entries that contain **inet example\_table example\_chain**:

```
# nft monitor | grep "inet example_table example_chain"
trace id 3c5eb15e inet example_table example_chain packet: iif "enp1s0" ether saddr
52:54:00:17:ff:e4 ether daddr 52:54:00:72:2f:6e ip saddr 192.0.2.1 ip daddr 192.0.2.2 ip dscp
cs0 ip ecn not-ect ip ttl 64 ip id 49710 ip protocol tcp ip length 60 tcp sport 56728 tcp dport
ssh tcp flags == syn tcp window 64240
trace id 3c5eb15e inet example_table example_chain rule tcp dport ssh nfttrace set 1 accept
(verdict accept)
...
```



### WARNING

Depending on the number of rules with tracing enabled and the amount of matching traffic, the **nft monitor** command can display a lot of output. Use **grep** or other utilities to filter the output.

## 41.11. BACKING UP AND RESTORING THE NFTABLES RULE SET

You can backup **nftables** rules to a file and later restoring them. Also, administrators can use a file with the rules to, for example, transfer the rules to a different server.

### 41.11.1. Backing up the nftables rule set to a file

You can use the **nft** utility to back up the **nftables** rule set to a file.

#### Procedure

- To backup **nftables** rules:
  - In a format produced by **nft list ruleset** format:

```
# nft list ruleset > file.nft
```

- In JSON format:

```
# nft -j list ruleset > file.json
```

### 41.11.2. Restoring the nftables rule set from a file

You can restore the **nftables** rule set from a file.

#### Procedure

- To restore **nftables** rules:
  - If the file to restore is in the format produced by **nft list ruleset** or contains **nft** commands directly:

```
# nft -f file.nft
```

- If the file to restore is in JSON format:

```
# nft -j -f file.json
```

## 41.12. ADDITIONAL RESOURCES

- [Using nftables in Red Hat Enterprise Linux 8](#)
- [What comes after iptables? Its successor, of course: nftables](#)
- [Firewalld: The Future is nftables](#)

## CHAPTER 42. USING XDP-FILTER FOR HIGH-PERFORMANCE TRAFFIC FILTERING TO PREVENT DDOS ATTACKS

Compared to packet filters, such as **nftables**, Express Data Path (XDP) processes and drops network packets right at the network interface. Therefore, XDP determines the next step for the package before it reaches a firewall or other applications. As a result, XDP filters require less resources and can process network packets at a much higher rate than conventional packet filters to defend against distributed denial of service (DDoS) attacks. For example, during testing, Red Hat dropped 26 million network packets per second on a single core, which is significantly higher than the drop rate of **nftables** on the same hardware.

The **xdp-filter** utility allows or drops incoming network packets using XDP. You can create rules to filter traffic to or from specific:

- IP addresses
- MAC addresses
- Ports

Note that, even if **xdp-filter** has a significantly higher packet-processing rate, it does not have the same capabilities as, for example, **nftables**. Consider **xdp-filter** a conceptual utility to demonstrate packet filtering using XDP. Additionally, you can use the code of the utility for a better understanding of how to write your own XDP applications.



### IMPORTANT

On other architectures than AMD and Intel 64-bit, the **xdp-filter** utility is provided as a Technology Preview only. Technology Preview features are not supported with Red Hat production Service Level Agreements (SLAs), might not be functionally complete, and Red Hat does not recommend using them for production. These previews provide early access to upcoming product features, enabling customers to test functionality and provide feedback during the development process.

See [Technology Preview Features Support Scope](#) on the Red Hat Customer Portal for information about the support scope for Technology Preview features.

### 42.1. DROPPING NETWORK PACKETS THAT MATCH AN XDP-FILTER RULE

You can use **xdp-filter** to drop network packets:

- To a specific destination port
- From a specific IP address
- From a specific MAC address

The **allow** policy of **xdp-filter** defines that all traffic is allowed and the filter drops only network packets that match a particular rule. For example, use this method if you know the source IP addresses of packets you want to drop.

#### Prerequisites

- The **xdp-tools** package is installed.
- A network driver that supports XDP programs.

### Procedure

1. Load **xdp-filter** to process incoming packets on a certain interface, such as **enp1s0**:

```
# xdp-filter load enp1s0
```

By default, **xdp-filter** uses the **allow** policy, and the utility drops only traffic that matches any rule.

Optionally, use the **-f feature** option to enable only particular features, such as **tcp**, **ipv4**, or **ethernet**. Loading only the required features instead of all of them increases the speed of packet processing. To enable multiple features, separate them with a comma.

If the command fails with an error, the network driver does not support XDP programs.

2. Add rules to drop packets that match them. For example:

- To drop incoming packets to port **22**, enter:

```
# xdp-filter port 22
```

This command adds a rule that matches TCP and UDP traffic. To match only a particular protocol, use the **-p protocol** option.

- To drop incoming packets from **192.0.2.1**, enter:

```
# xdp-filter ip 192.0.2.1 -m src
```

Note that **xdp-filter** does not support IP ranges.

- To drop incoming packets from MAC address **00:53:00:AA:07:BE**, enter:

```
# xdp-filter ether 00:53:00:AA:07:BE -m src
```

### Verification

- Use the following command to display statistics about dropped and allowed packets:

```
# xdp-filter status
```

### Additional resources

- **xdp-filter(8)** man page
- If you are a developer and interested in the code of **xdp-filter**, download and install the corresponding source RPM (SRPM) from the Red Hat Customer Portal.

## 42.2. DROPPING ALL NETWORK PACKETS EXCEPT THE ONES THAT MATCH AN XDP-FILTER RULE

You can use **xdp-filter** to allow only network packets:

- From and to a specific destination port
- From and to a specific IP address
- From and to specific MAC address

To do so, use the **deny** policy of **xdp-filter** which defines that the filter drops all network packets except the ones that match a particular rule. For example, use this method if you do not know the source IP addresses of packets you want to drop.



### WARNING

If you set the default policy to **deny** when you load **xdp-filter** on an interface, the kernel immediately drops all packets from this interface until you create rules that allow certain traffic. To avoid being locked out from the system, enter the commands locally or connect through a different network interface to the host.

### Prerequisites

- The **xdp-tools** package is installed.
- You are logged in to the host either locally or using a network interface for which you do not plan to filter the traffic.
- A network driver that supports XDP programs.

### Procedure

1. Load **xdp-filter** to process packets on a certain interface, such as **enp1s0**:

```
# xdp-filter load enp1s0 -p deny
```

Optionally, use the **-f feature** option to enable only particular features, such as **tcp**, **ipv4**, or **ethernet**. Loading only the required features instead of all of them increases the speed of packet processing. To enable multiple features, separate them with a comma.

If the command fails with an error, the network driver does not support XDP programs.

2. Add rules to allow packets that match them. For example:

- To allow packets to port **22**, enter:

```
# xdp-filter port 22
```

This command adds a rule that matches TCP and UDP traffic. To match only a particular protocol, pass the **-p protocol** option to the command.

- To allow packets to **192.0.2.1**, enter:

```
# xdp-filter ip 192.0.2.1
```

Note that **xdp-filter** does not support IP ranges.

- To allow packets to MAC address **00:53:00:AA:07:BE**, enter:

```
# xdp-filter ether 00:53:00:AA:07:BE
```

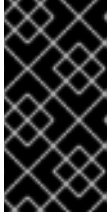

### IMPORTANT

The **xdp-filter** utility does not support stateful packet inspection. This requires that you either do not set a mode using the **-m mode** option or you add explicit rules to allow incoming traffic that the machine receives in reply to outgoing traffic.

### Verification

- Use the following command to display statistics about dropped and allowed packets:

```
# xdp-filter status
```

### Additional resources

- **xdp-filter(8)** man page.
- If you are a developer and you are interested in the code of **xdp-filter**, download and install the corresponding source RPM (SRPM) from the Red Hat Customer Portal.

## CHAPTER 43. CAPTURING NETWORK PACKETS

To debug network issues and communications, you can capture network packets. The following sections provide instructions and additional information about capturing network packets.

### 43.1. USING XDPDUMP TO CAPTURE NETWORK PACKETS INCLUDING PACKETS DROPPED BY XDP PROGRAMS

The **xdpdump** utility captures network packets. Unlike the **tcpdump** utility, **xdpdump** uses an extended Berkeley Packet Filter (eBPF) program for this task. This enables **xdpdump** to also capture packets dropped by Express Data Path (XDP) programs. User-space utilities, such as **tcpdump**, are not able to capture these dropped packages, as well as original packets modified by an XDP program.

You can use **xdpdump** to debug XDP programs that are already attached to an interface. Therefore, the utility can capture packets before an XDP program is started and after it has finished. In the latter case, **xdpdump** also captures the XDP action. By default, **xdpdump** captures incoming packets at the entry of the XDP program.



#### IMPORTANT

On other architectures than AMD and Intel 64-bit, the **xdpdump** utility is provided as a Technology Preview only. Technology Preview features are not supported with Red Hat production Service Level Agreements (SLAs), might not be functionally complete, and Red Hat does not recommend using them for production. These previews provide early access to upcoming product features, enabling customers to test functionality and provide feedback during the development process.

See [Technology Preview Features Support Scope](#) on the Red Hat Customer Portal for information about the support scope for Technology Preview features.

Note that **xdpdump** has no packet filter or decode capabilities. However, you can use it in combination with **tcpdump** for packet decoding.

#### Prerequisites

- A network driver that supports XDP programs.
- An XDP program is loaded to the **enp1s0** interface. If no program is loaded, **xdpdump** captures packets in a similar way **tcpdump** does, for backward compatibility.

#### Procedure

1. To capture packets on the **enp1s0** interface and write them to the **/root/capture.pcap** file, enter:

```
# xdpdump -i enp1s0 -w /root/capture.pcap
```

2. To stop capturing packets, press **Ctrl+C**.

#### Additional resources

- **xdpdump(8)** man page



- If you are a developer and you are interested in the source code of **xdpdump**, download and install the corresponding source RPM (SRPM) from the Red Hat Customer Portal.

## 43.2. ADDITIONAL RESOURCES

- [How to capture network packets with tcpdump?](#)

## CHAPTER 44. UNDERSTANDING THE EBPF NETWORKING FEATURES IN RHEL 8

The extended Berkeley Packet Filter (eBPF) is an in-kernel virtual machine that allows code execution in the kernel space. This code runs in a restricted sandbox environment with access only to a limited set of functions.

In networking, you can use eBPF to complement or replace kernel packet processing. Depending on the hook you use, eBPF programs have, for example:

- Read and write access to packet data and metadata
- Can look up sockets and routes
- Can set socket options
- Can redirect packets

### 44.1. OVERVIEW OF NETWORKING EBPF FEATURES IN RHEL 8

You can attach extended Berkeley Packet Filter (eBPF) networking programs to the following hooks in RHEL:

- **eXpress Data Path (XDP)**: Provides early access to received packets before the kernel networking stack processes them.
- **tc** eBPF classifier with direct-action flag: Provides powerful packet processing on ingress and egress.
- **Control Groups version 2 (cgroup v2)**: Enables filtering and overriding socket-based operations performed by programs in a control group.
- **Socket filtering**: Enables filtering of packets received from sockets. This feature was also available in the classic Berkeley Packet Filter (cBPF), but has been extended to support eBPF programs.
- **Stream parser**: Enables splitting up streams to individual messages, filtering, and redirecting them to sockets.
- **SO\_REUSEPORT** socket selection: Provides a programmable selection of a receiving socket from a **reuseport** socket group.
- **Flow dissector**: Enables overriding the way the kernel parses packet headers in certain situations.
- **TCP congestion control callbacks**: Enables implementing a custom TCP congestion control algorithm.
- **Routes with encapsulation**: Enables creating custom tunnel encapsulation.

Note that Red Hat does not support all of the eBPF functionality that is available in RHEL and described here. For further details and the support status of the individual hooks, see the [RHEL 8 Release Notes](#) and the following overview.

#### XDP

You can attach programs of the **BPF\_PROG\_TYPE\_XDP** type to a network interface. The kernel then

executes the program on received packets before the kernel network stack starts processing them. This allows fast packet forwarding in certain situations, such as fast packet dropping to prevent distributed denial of service (DDoS) attacks and fast packet redirects for load balancing scenarios.

You can also use XDP for different forms of packet monitoring and sampling. The kernel allows XDP programs to modify packets and to pass them for further processing to the kernel network stack.

The following XDP modes are available:

- **Native (driver) XDP:** The kernel executes the program from the earliest possible point during packet reception. At this moment, the kernel did not parse the packet and, therefore, no metadata provided by the kernel is available. This mode requires that the network interface driver supports XDP but not all drivers support this native mode.
- **Generic XDP:** The kernel network stack executes the XDP program early in the processing. At that time, kernel data structures have been allocated, and the packet has been pre-processed. If a packet should be dropped or redirected, it requires a significant overhead compared to the native mode. However, the generic mode does not require network interface driver support and works with all network interfaces.
- **Offloaded XDP:** The kernel executes the XDP program on the network interface instead of on the host CPU. Note that this requires specific hardware, and only certain eBPF features are available in this mode.

On RHEL, load all XDP programs using the **libxdp** library. This library enables system-controlled usage of XDP.



#### NOTE

Currently, there are some system configuration limitations for XDP programs. For example, you must disable certain hardware offload features on the receiving interface. Additionally, not all features are available with all drivers that support the native mode.

In RHEL 8.7, Red Hat supports the XDP feature only if all of the following conditions apply:

- You load the XDP program on an AMD or Intel 64-bit architecture.
- You use the **libxdp** library to load the program into the kernel.
- The XDP program does not use the XDP hardware offloading.

Additionally, Red Hat provides the following usage of XDP features as unsupported Technology Preview:

- Loading XDP programs on architectures other than AMD and Intel 64-bit. Note that the **libxdp** library is not available for architectures other than AMD and Intel 64-bit.
- The XDP hardware offloading.

#### AF\_XDP

Using an XDP program that filters and redirects packets to a given **AF\_XDP** socket, you can use one or more sockets from the **AF\_XDP** protocol family to quickly copy packets from the kernel to the user space.

In RHEL 8.7, Red Hat provides this feature as an unsupported Technology Preview.

## Traffic Control

The Traffic Control (**tc**) subsystem offers the following types of eBPF programs:

- **BPF\_PROG\_TYPE\_SCHED\_CLS**
- **BPF\_PROG\_TYPE\_SCHED\_ACT**

These types enable you to write custom **tc** classifiers and **tc** actions in eBPF. Together with the parts of the **tc** ecosystem, this provides the ability for powerful packet processing and is the core part of several container networking orchestration solutions.

In most cases, only the classifier is used, as with the direct-action flag, the eBPF classifier can execute actions directly from the same eBPF program. The **clsact** Queueing Discipline (**qdisc**) has been designed to enable this on the ingress side.

Note that using a flow dissector eBPF program can influence operation of some other **qdiscs** and **tc** classifiers, such as **flower**.

The eBPF for **tc** feature is fully supported in RHEL 8.2 and later.

## Socket filter

Several utilities use or have used the classic Berkeley Packet Filter (cBPF) for filtering packets received on a socket. For example, the **tcpdump** utility enables the user to specify expressions, which **tcpdump** then translates into cBPF code.

As an alternative to cBPF, the kernel allows eBPF programs of the **BPF\_PROG\_TYPE\_SOCKET\_FILTER** type for the same purpose.

In RHEL 8.7, Red Hat provides this feature as an unsupported Technology Preview.

## Control Groups

In RHEL, you can use multiple types of eBPF programs that you can attach to a cgroup. The kernel executes these programs when a program in the given cgroup performs an operation. Note that you can use only cgroups version 2.

The following networking-related cgroup eBPF programs are available in RHEL:

- **BPF\_PROG\_TYPE SOCK\_OPS**: The kernel calls this program on various TCP events. The program can adjust the behavior of the kernel TCP stack, including custom TCP header options, and so on.
- **BPF\_PROG\_TYPE CGROUP SOCK\_ADDR**: The kernel calls this program during **connect**, **bind**, **sendto**, **recvmsg**, **getpeername**, and **getsockname** operations. This program allows changing IP addresses and ports. This is useful when you implement socket-based network address translation (NAT) in eBPF.
- **BPF\_PROG\_TYPE CGROUP SOCKOPT**: The kernel calls this program during **setsockopt** and **getsockopt** operations and allows changing the options.
- **BPF\_PROG\_TYPE CGROUP SOCK**: The kernel calls this program during socket creation, socket releasing, and binding to addresses. You can use these programs to allow or deny the operation, or only to inspect socket creation for statistics.
- **BPF\_PROG\_TYPE CGROUP SKB**: This program filters individual packets on ingress and egress, and can accept or reject packets.

- **BPF\_PROG\_TYPE\_CGROUP\_SYSCTL**: This program allows filtering of access to system controls (**sysctl**).
- **BPF\_CGROUP\_INET4\_GETPEERNAME**, **BPF\_CGROUP\_INET6\_GETPEERNAME**, **BPF\_CGROUP\_INET4\_GETSOCKNAME**, and **BPF\_CGROUP\_INET6\_GETSOCKNAME**: Using these programs, you can override the result of **getsockname** and **getpeername** system calls. This is useful when you implement socket-based network address translation (NAT) in eBPF.

In RHEL 8.7, Red Hat provides this feature as an unsupported Technology Preview.

### Stream Parser

A stream parser operates on a group of sockets that are added to a special eBPF map. The eBPF program then processes packets that the kernel receives or sends on those sockets.

The following stream parser eBPF programs are available in RHEL:

- **BPF\_PROG\_TYPE\_SK\_SKB**: An eBPF program parses packets received from the socket into individual messages, and instructs the kernel to drop those messages or send them to another socket in the group.
- **BPF\_PROG\_TYPE\_SK\_MSG**: This program filters egress messages. An eBPF program parses the packets into individual messages and either approves or rejects them.

In RHEL 8.7, Red Hat provides this feature as an unsupported Technology Preview.

### SO\_REUSEPORT socket selection

Using this socket option, you can bind multiple sockets to the same IP address and port. Without eBPF, the kernel selects the receiving socket based on a connection hash. With the **BPF\_PROG\_TYPE\_SK\_REUSEPORT** program, the selection of the receiving socket is fully programmable.

In RHEL 8.7, Red Hat provides this feature as an unsupported Technology Preview.

### Flow dissector

When the kernel needs to process packet headers without going through the full protocol decode, they are **dissected**. For example, this happens in the **tc** subsystem, in multipath routing, in bonding, or when calculating a packet hash. In this situation the kernel parses the packet headers and fills internal structures with the information from the packet headers. You can replace this internal parsing using the **BPF\_PROG\_TYPE\_FLOW\_DISSECTOR** program. Note that you can only dissect TCP and UDP over IPv4 and IPv6 in eBPF in RHEL.

In RHEL 8.7, Red Hat provides this feature as an unsupported Technology Preview.

### TCP Congestion Control

You can write a custom TCP congestion control algorithm using a group of **BPF\_PROG\_TYPE\_STRUCT\_OPS** programs that implement **struct tcp\_congestion\_oops** callbacks. An algorithm that is implemented this way is available to the system alongside the built-in kernel algorithms.

In RHEL 8.7, Red Hat provides this feature as an unsupported Technology Preview.

### Routes with encapsulation

You can attach one of the following eBPF program types to routes in the routing table as a tunnel encapsulation attribute:

- **BPF\_PROG\_TYPE\_LWT\_IN**

- **BPF\_PROG\_TYPE\_LWT\_OUT**
- **BPF\_PROG\_TYPE\_LWT\_XMIT**

The functionality of such an eBPF program is limited to specific tunnel configurations and does not allow creating a generic encapsulation or decapsulation solution.

In RHEL 8.7, Red Hat provides this feature as an unsupported Technology Preview.

### Socket lookup

To bypass limitations of the **bind** system call, use an eBPF program of the **BPF\_PROG\_TYPE\_SK\_LOOKUP** type. Such programs can select a listening socket for new incoming TCP connections or an unconnected socket for UDP packets.

In RHEL 8.7, Red Hat provides this feature as an unsupported Technology Preview.

## 44.2. OVERVIEW OF XDP FEATURES IN RHEL 8 BY NETWORK CARDS

The following is an overview of XDP-enabled network cards and the XDP features you can use with them:

Network card	Driver	Basic	Redirect	Target	HW offload	Zero-copy
Amazon Elastic Network Adapter	<b>ena</b>	yes	yes	yes <sup>[a]</sup>	no	no
Broadcom NetXtreme-C/E 10/25/40/50 gigabit Ethernet	<b>bnxt_en</b>	yes	yes	yes <sup>[a]</sup>	no	no
Cavium Thunder Virtual function	<b>nicvf</b>	yes	no	no	no	no
Google Virtual NIC (gVNIC) support	<b>gve</b>	yes	yes	yes	no	yes
Intel® 10GbE PCI Express Virtual Function Ethernet	<b>ixgbev</b>	yes	no	no	no	no
Intel® 10GbE PCI Express adapters	<b>ixgbe</b>	yes	yes	yes <sup>[a]</sup>	no	yes
Intel® Ethernet Connection E800 Series	<b>ice</b>	yes	yes	yes <sup>[a]</sup>	no	yes
Intel® Ethernet Controller I225-LM/I225-V family	<b>igc</b>	yes	yes	yes	no	yes
Intel® Ethernet Controller XL710 Family	<b>i40e</b>	yes	yes	yes <sup>[a]</sup> [b]	no	yes
Intel® PCI Express Gigabit adapters	<b>igb</b>	yes	yes	yes <sup>[a]</sup>	no	no

Network card	Driver	Basic	Redirect	Target	HW offload	Zero-copy
Mellanox 5th generation network adapters (ConnectX series)	<b>mlx5_core</b>	yes	yes	yes <sup>[b]</sup>	no	yes
Mellanox Technologies 1/10/40Gbit Ethernet	<b>mlx4_en</b>	yes	yes	no	no	no
Microsoft Azure Network Adapter	<b>mana</b>	yes	yes	yes	no	no
Microsoft Hyper-V virtual network	<b>hv_netvsc</b>	yes	yes	yes	no	no
Netronome® NFP4000/NFP6000 NIC	<b>nfp</b>	yes	no	no	yes	no
QEMU Virtio network	<b>virtio_net</b>	yes	yes	yes <sup>[a]</sup>	no	no
QLogic QED 25/40/100Gb Ethernet NIC	<b>qede</b>	yes	yes	yes	no	no
Solarflare SFC9000/SFC9100/EF100-family	<b>sfc</b>	yes	yes	yes <sup>[b]</sup>	no	no
Universal TUN/TAP device	<b>tun</b>	yes	yes	yes	no	no
Virtual Ethernet pair device	<b>veth</b>	yes	yes	yes	no	no
<p>[a] Only if an XDP program is loaded on the interface.</p> <p>[b] Requires several XDP TX queues allocated that is larger or equal to the largest CPU index.</p>						

## Legend:

- Basic: Supports basic return codes: **DROP**, **PASS**, **ABORTED**, and **TX**.
- Redirect: Supports the **REDIRECT** return code.
- Target: Can be a target of a **REDIRECT** return code.
- HW offload: Supports XDP hardware offload.
- Zero-copy: Supports the zero-copy mode for the **AF\_XDP** protocol family.

## CHAPTER 45. NETWORK TRACING USING THE BPF COMPILER COLLECTION

BPF Compiler Collection (BCC) is a library, which facilitates the creation of the extended Berkeley Packet Filter (eBPF) programs. The main utility of eBPF programs is analyzing the operating system performance and network performance without experiencing overhead or security issues.

BCC removes the need for users to know deep technical details of eBPF, and provides many out-of-the-box starting points, such as the **bcc-tools** package with pre-created eBPF programs.



### NOTE

The eBPF programs are triggered on events, such as disk I/O, TCP connections, and process creations. It is unlikely that the programs should cause the kernel to crash, loop or become unresponsive because they run in a safe virtual machine in the kernel.

### 45.1. INSTALLING THE BCC-TOOLS PACKAGE

Install the **bcc-tools** package, which also installs the BPF Compiler Collection (BCC) library as a dependency.

#### Procedure

1. Install **bcc-tools**.

```
# yum install bcc-tools
```

The BCC tools are installed in the **/usr/share/bcc/tools/** directory.

2. Optionally, inspect the tools:

```
# ll /usr/share/bcc/tools/
...
-rwxr-xr-x. 1 root root 4198 Dec 14 17:53 dcsnoop
-rwxr-xr-x. 1 root root 3931 Dec 14 17:53 dcstat
-rwxr-xr-x. 1 root root 20040 Dec 14 17:53 deadlock_detector
-rw-r--r--. 1 root root 7105 Dec 14 17:53 deadlock_detector.c
drwxr-xr-x. 3 root root 8192 Mar 11 10:28 doc
-rwxr-xr-x. 1 root root 7588 Dec 14 17:53 execsnoop
-rwxr-xr-x. 1 root root 6373 Dec 14 17:53 ext4dist
-rwxr-xr-x. 1 root root 10401 Dec 14 17:53 ext4slower
...
```

The **doc** directory in the listing above contains documentation for each tool.

### 45.2. DISPLAYING TCP CONNECTIONS ADDED TO THE KERNEL'S ACCEPT QUEUE

After the kernel receives the **ACK** packet in a TCP 3-way handshake, the kernel moves the connection from the **SYN** queue to the **accept** queue after the connection's state changes to **ESTABLISHED**. Therefore, only successful TCP connections are visible in this queue.

The **tcpaccept** utility uses eBPF features to display all connections the kernel adds to the **accept**



queue. The utility is lightweight because it traces the **accept()** function of the kernel instead of capturing packets and filtering them. For example, use **tcpaccept** for general troubleshooting to display new connections the server has accepted.

### Procedure

1. Enter the following command to start the tracing the kernel **accept** queue:

```
# /usr/share/bcc/tools/tcpaccept
PID COMM  IP RADDR  RPORT LADDR  LPORT
843  sshd   4 192.0.2.17 50598 192.0.2.1 22
1107 ns-slapd 4 198.51.100.6 38772 192.0.2.1 389
1107 ns-slapd 4 203.0.113.85 38774 192.0.2.1 389
...
```

Each time the kernel accepts a connection, **tcpaccept** displays the details of the connections.

2. Press **Ctrl+C** to stop the tracing process.

### Additional resources

- **tcpaccept(8)** man page
- `/usr/share/bcc/tools/doc/tcpaccept_example.txt` file

## 45.3. TRACING OUTGOING TCP CONNECTION ATTEMPTS

The **tcpconnect** utility uses eBPF features to trace outgoing TCP connection attempts. The output of the utility also includes connections that failed.

The **tcpconnect** utility is lightweight because it traces, for example, the **connect()** function of the kernel instead of capturing packets and filtering them.

### Procedure

1. Enter the following command to start the tracing process that displays all outgoing connections:

```
# /usr/share/bcc/tools/tcpconnect
PID COMM  IP SADDR  DADDR  DPORT
31346 curl   4 192.0.2.1 198.51.100.16 80
31348 telnet 4 192.0.2.1 203.0.113.231 23
31361 isc-worker00 4 192.0.2.1 192.0.2.254 53
...
```

Each time the kernel processes an outgoing connection, **tcpconnect** displays the details of the connections.

2. Press **Ctrl+C** to stop the tracing process.

### Additional resources

- **tcpconnect(8)** man page
- `/usr/share/bcc/tools/doc/tcpconnect_example.txt` file

## 45.4. MEASURING THE LATENCY OF OUTGOING TCP CONNECTIONS

The TCP connection latency is the time taken to establish a connection. This typically involves the kernel TCP/IP processing and network round trip time, and not the application runtime.

The **tcpconnl** utility uses eBPF features to measure the time between a sent **SYN** packet and the received response packet.

### Procedure

1. Start measuring the latency of outgoing connections:

```
# /usr/share/bcc/tools/tcpconnl
PID COMM      IP SADDR  DADDR      DPORT LAT(ms)
32151 isc-worker00 4 192.0.2.1 192.0.2.254 53 0.60
32155 ssh        4 192.0.2.1 203.0.113.190 22 26.34
32319 curl       4 192.0.2.1 198.51.100.59 443 188.96
...
```

Each time the kernel processes an outgoing connection, **tcpconnl** displays the details of the connection after the kernel receives the response packet.

2. Press **Ctrl+C** to stop the tracing process.

### Additional resources

- **tcpconnl(8)** man page
- `/usr/share/bcc/tools/doc/tcpconnl_example.txt` file

## 45.5. DISPLAYING DETAILS ABOUT TCP PACKETS AND SEGMENTS THAT WERE DROPPED BY THE KERNEL

The **tcpdrop** utility enables administrators to display details about TCP packets and segments that were dropped by the kernel. Use this utility to debug high rates of dropped packets that can cause the remote system to send timer-based retransmits. High rates of dropped packets and segments can impact the performance of a server.

Instead of capturing and filtering packets, which is resource-intensive, the **tcpdrop** utility uses eBPF features to retrieve the information directly from the kernel.

### Procedure

1. Enter the following command to start displaying details about dropped TCP packets and segments:

```
# /usr/share/bcc/tools/tcpdrop
TIME  PID  IP SADDR:SPORT  > DADDR:DPORT  STATE (FLAGS)
13:28:39 32253 4 192.0.2.85:51616 > 192.0.2.1:22 CLOSE_WAIT (FIN|ACK)
b'tcp_drop+0x1'
b'tcp_data_queue+0x2b9'
...

13:28:39 1 4 192.0.2.85:51616 > 192.0.2.1:22 CLOSE (ACK)
```

```
b'tcp_drop+0x1'
b'tcp_rcv_state_process+0xe2'
...
```

Each time the kernel drops TCP packets and segments, **tcpdrop** displays the details of the connection, including the kernel stack trace that led to the dropped package.

2. Press **Ctrl+C** to stop the tracing process.

### Additional resources

- **tcpdrop(8)** man page
- `/usr/share/bcc/tools/doc/tcpdrop_example.txt` file

## 45.6. TRACING TCP SESSIONS

The **tcplife** utility uses eBPF to trace TCP sessions that open and close, and prints a line of output to summarize each one. Administrators can use **tcplife** to identify connections and the amount of transferred traffic.

For example, you can display connections to port **22** (SSH) to retrieve the following information:

- The local process ID (PID)
- The local process name
- The local IP address and port number
- The remote IP address and port number
- The amount of received and transmitted traffic in KB.
- The time in milliseconds the connection was active

### Procedure

1. Enter the following command to start the tracing of connections to the local port **22**:

```
/usr/share/bcc/tools/tcplife -L 22
PID COMM  LADDR  LPORT RADDR  RPORT TX_KB RX_KB  MS
19392 sshd  192.0.2.1 22 192.0.2.17 43892 53 52 6681.95
19431 sshd  192.0.2.1 22 192.0.2.245 43902 81 249381 7585.09
19487 sshd  192.0.2.1 22 192.0.2.121 43970 6998 7 16740.35
...
```

Each time a connection is closed, **tcplife** displays the details of the connections.

2. Press **Ctrl+C** to stop the tracing process.

### Additional resources

- **tcplife(8)** man page
- `/usr/share/bcc/tools/doc/tcplife_example.txt` file

## 45.7. TRACING TCP RETRANSMISSIONS

The **tcpretrans** utility displays details about TCP retransmissions, such as the local and remote IP address and port number, as well as the TCP state at the time of the retransmissions.

The utility uses eBPF features and, therefore, has a very low overhead.

### Procedure

1. Use the following command to start displaying TCP retransmission details:

```
# /usr/share/bcc/tools/tcpretrans
TIME   PID IP LADDR:LPORT  T> RADDR:RPORT   STATE
00:23:02 0  4 192.0.2.1:22 R> 198.51.100.0:26788 ESTABLISHED
00:23:02 0  4 192.0.2.1:22 R> 198.51.100.0:26788 ESTABLISHED
00:45:43 0  4 192.0.2.1:22 R> 198.51.100.0:17634 ESTABLISHED
...
```

Each time the kernel calls the TCP retransmit function, **tcpretrans** displays the details of the connection.

2. Press **Ctrl+C** to stop the tracing process.

### Additional resources

- **tcpretrans(8)** man page
- **/usr/share/bcc/tools/doc/tcpretrans\_example.txt** file

## 45.8. DISPLAYING TCP STATE CHANGE INFORMATION

During a TCP session, the TCP state changes. The **tcpstates** utility uses eBPF functions to trace these state changes, and prints details including the duration in each state. For example, use **tcpstates** to identify if connections spend too much time in the initialization state.

### Procedure

1. Use the following command to start tracing TCP state changes:

```
# /usr/share/bcc/tools/tcpstates
SKADDR      C-PID C-COMM  LADDR  LPORT RADDR  RPORT OLDSTATE  ->
NEWSTATE  MS
ffff9cd377b3af80 0  swapper/1 0.0.0.0 22 0.0.0.0 0 LISTEN  -> SYN_RECV
0.000
ffff9cd377b3af80 0  swapper/1 192.0.2.1 22 192.0.2.45 53152 SYN_RECV  ->
ESTABLISHED 0.067
ffff9cd377b3af80 818  sssd_nss 192.0.2.1 22 192.0.2.45 53152 ESTABLISHED ->
CLOSE_WAIT 65636.773
ffff9cd377b3af80 1432  sshd 192.0.2.1 22 192.0.2.45 53152 CLOSE_WAIT ->
LAST_ACK 24.409
ffff9cd377b3af80 1267  pulseaudio 192.0.2.1 22 192.0.2.45 53152 LAST_ACK ->
CLOSE 0.376
...
```

Each time a connection changes its state, **tcpstates** displays a new line with updated connection details.

If multiple connections change their state at the same time, use the socket address in the first column (**SKADDR**) to determine which entries belong to the same connection.

2. Press **Ctrl+C** to stop the tracing process.

### Additional resources

- **tcpstates(8)** man page
- `/usr/share/bcc/tools/doc/tcpstates_example.txt` file

## 45.9. SUMMARIZING AND AGGREGATING TCP TRAFFIC SENT TO SPECIFIC SUBNETS

The **tcpsubnet** utility summarizes and aggregates IPv4 TCP traffic that the local host sends to subnets and displays the output on a fixed interval. The utility uses eBPF features to collect and summarize the data to reduce the overhead.

By default, **tcpsubnet** summarizes traffic for the following subnets:

- **127.0.0.1/32**
- **10.0.0.0/8**
- **172.16.0.0/12**
- **192.0.2.0/24/16**
- **0.0.0.0/0**

Note that the last subnet (**0.0.0.0/0**) is a catch-all option. The **tcpsubnet** utility counts all traffic for subnets different than the first four in this catch-all entry.

Follow the procedure to count the traffic for the **192.0.2.0/24** and **198.51.100.0/24** subnets. Traffic to other subnets will be tracked in the **0.0.0.0/0** catch-all subnet entry.

### Procedure

1. Start monitoring the amount of traffic sent to the **192.0.2.0/24**, **198.51.100.0/24**, and other subnets:

```
# /usr/share/bcc/tools/tcpsubnet 192.0.2.0/24,198.51.100.0/24,0.0.0.0/0
Tracing... Output every 1 secs. Hit Ctrl-C to end
[02/21/20 10:04:50]
192.0.2.0/24      856
198.51.100.0/24  7467
[02/21/20 10:04:51]
192.0.2.0/24      1200
198.51.100.0/24  8763
0.0.0.0/0         673
...
```

This command displays the traffic in bytes for the specified subnets once per second.

2. Press **Ctrl+C** to stop the tracing process.

#### Additional resources

- **tcpsubnet(8)** man page
- `/usr/share/bcc/tools/doc/tcpsubnet.txt` file

## 45.10. DISPLAYING THE NETWORK THROUGHPUT BY IP ADDRESS AND PORT

The **tcptop** utility displays TCP traffic the host sends and receives in kilobytes. The report automatically refreshes and contains only active TCP connections. The utility uses eBPF features and, therefore, has only a very low overhead.

#### Procedure

1. To monitor the sent and received traffic, enter:

```
# /usr/share/bcc/tools/tcptop
13:46:29 loadavg: 0.10 0.03 0.01 1/215 3875

PID  COMM      LADDR      RADDR      RX_KB  TX_KB
3853 3853      192.0.2.1:22 192.0.2.165:41838 32    102626
1285 sshd      192.0.2.1:22 192.0.2.45:39240 0      0
...
```

The output of the command includes only active TCP connections. If the local or remote system closes a connection, the connection is no longer visible in the output.

2. Press **Ctrl+C** to stop the tracing process.

#### Additional resources

- **tcptop(8)** man page
- `/usr/share/bcc/tools/doc/tcptop.txt` file

## 45.11. TRACING ESTABLISHED TCP CONNECTIONS

The **tcptracer** utility traces the kernel functions that connect, accept, and close TCP connections. The utility uses eBPF features and, therefore, has a very low overhead.

#### Procedure

1. Use the following command to start the tracing process:

```
# /usr/share/bcc/tools/tcptracer
Tracing TCP established connections. Ctrl-C to end.
T PID  COMM      IP SADDR      DADDR      SPORT  DPORT
A 1088 ns-slapd  4 192.0.2.153 192.0.2.1  0     65535
```

```
A 845  sshd    4 192.0.2.1 192.0.2.67 22 42302
X 4502  sshd    4 192.0.2.1 192.0.2.67 22 42302
...
```

Each time the kernel connects, accepts, or closes a connection, **tcptracer** displays the details of the connections.

2. Press **Ctrl+C** to stop the tracing process.

### Additional resources

- **tcptracer(8)** man page
- `/usr/share/bcc/tools/doc/tcptracer_example.txt` file

## 45.12. TRACING IPV4 AND IPV6 LISTEN ATTEMPTS

The **solisten** utility traces all IPv4 and IPv6 listen attempts. It traces the listen attempts including that ultimately fail or the listening program that does not accept the connection. The utility traces function that the kernel calls when a program wants to listen for TCP connections.

### Procedure

1. Enter the following command to start the tracing process that displays all listen TCP attempts:

```
# /usr/share/bcc/tools/solisten
PID COMM      PROTO  BACKLOG  PORT  ADDR
3643 nc         TCPv4   1      4242  0.0.0.0
3659 nc         TCPv6   1      4242  2001:db8:1::1
4221 redis-server TCPv6   128    6379  ::
4221 redis-server TCPv4   128    6379  0.0.0.0
....
```

2. Press **Ctrl+C** to stop the tracing process.

### Additional resources

- **solisten(9)** man page
- `/usr/share/bcc/tools/doc/solisten_example.txt` file

## 45.13. SUMMARIZING THE SERVICE TIME OF SOFT INTERRUPTS

The **softirqs** utility summarizes the time spent servicing soft interrupts (soft IRQs) and shows this time as either totals or histogram distributions. This utility uses the **irq:softirq\_enter** and **irq:softirq\_exit** kernel tracepoints, which is a stable tracing mechanism.

### Procedure

1. Enter the following command to start the tracing **soft irq** event time:

```
# /usr/share/bcc/tools/softirqs
Tracing soft irq event time... Hit Ctrl-C to end.
^C
```

```

SOFTIRQ      TOTAL_usecs
tasklet      166
block        9152
net_rx       12829
rcu          53140
sched        182360
timer        306256

```

2. Press **Ctrl+C** to stop the tracing process.

#### Additional resources

- **softirqs(8)** man page
- **/usr/share/bcc/tools/doc/softirqs\_example.txt** file
- **mpstat(1)** man page

## 45.14. SUMMARIZING PACKETS SIZE AND COUNT ON A NETWORK INTERFACE

The **netqtop** utility displays statistics about the attributes of received (RX) and transmitted (TX) packets on each network queue of a particular network interface. The statistics include:

- Bytes per second (BPS)
- Packets per second (PPS)
- The average packet size
- Total number of packets

To generate these statistics, **netqtop** traces the kernel functions that perform events of transmitted packets **net\_dev\_start\_xmit** and received packets **netif\_receive\_skb**.

#### Procedure

1. Display the number of packets within the range of bytes size of the time interval of **2** seconds:

```

# /usr/share/bcc/tools/netqtop -n enp1s0 -i 2

Fri Jan 31 18:08:55 2023
TX
QueueID avg_size [0, 64) [64, 512) [512, 2K) [2K, 16K) [16K, 64K)
0 0 0 0 0 0 0
Total 0 0 0 0 0 0

RX
QueueID avg_size [0, 64) [64, 512) [512, 2K) [2K, 16K) [16K, 64K)
0 38.0 1 0 0 0 0
Total 38.0 1 0 0 0 0

-----
Fri Jan 31 18:08:57 2023
TX
QueueID avg_size [0, 64) [64, 512) [512, 2K) [2K, 16K) [16K, 64K)

```



```
0 0 0 0 0 0 0
Total 0 0 0 0 0 0

RX
QueueID avg_size [0, 64) [64, 512) [512, 2K) [2K, 16K) [16K, 64K)
0 38.0 1 0 0 0 0
Total 38.0 1 0 0 0 0
-----
```

2. Press **Ctrl+C** to stop **netqtop**.

#### Additional resources

- **netqtop(8)** man page
- `/usr/share/bcc/tools/doc/netqtop_example.txt`

## 45.15. ADDITIONAL RESOURCES

- `/usr/share/doc/bcc/README.md`

## CHAPTER 46. CONFIGURING NETWORK DEVICES TO ACCEPT TRAFFIC FROM ALL MAC ADDRESSES

Network devices usually intercept and read packets that their controller is programmed to receive. You can configure the network devices to accept traffic from all MAC addresses in a virtual switch or at the port group level.

You can use this network mode to:

- Diagnose network connectivity issues
- Monitor network activity for security reasons
- Intercept private data-in-transit or intrusion in the network

You can enable this mode for any kind of network device, except **InfiniBand**.

### 46.1. TEMPORARILY CONFIGURING A DEVICE TO ACCEPT ALL TRAFFIC

You can use the **ip** utility to temporary configure a network device to accept all traffic regardless of the MAC addresses.

#### Procedure

1. Optional: Display the network interfaces to identify the one for which you want to receive all traffic:

```
# ip address show
1: enp1s0: <NO-CARRIER,BROADCAST,MULTICAST,UP> mtu 1500 qdisc fq_codel state
DOWN group default qlen 1000
    link/ether 98:fa:9b:a4:34:09 brd ff:ff:ff:ff:ff:ff
    ...
```

2. Modify the device to enable or disable this property:

- To enable the **accept-all-mac-addresses** mode for **enp1s0**:

```
# ip link set enp1s0 promisc on
```

- To disable the **accept-all-mac-addresses** mode for **enp1s0**:

```
# ip link set enp1s0 promisc off
```

#### Verification

- Verify that the **accept-all-mac-addresses** mode is enabled:

```
# ip link show enp1s0
1: enp1s0: <NO-CARRIER,BROADCAST,MULTICAST,PROMISC,UP> mtu 1500 qdisc
fq_codel state DOWN mode DEFAULT group default qlen 1000
    link/ether 98:fa:9b:a4:34:09 brd ff:ff:ff:ff:ff:ff
```

The **PROMISC** flag in the device description indicates that the mode is enabled.

## 46.2. PERMANENTLY CONFIGURING A NETWORK DEVICE TO ACCEPT ALL TRAFFIC USING NMCLI

You can use the **nmcli** utility to permanently configure a network device to accept all traffic regardless of the MAC addresses.

### Procedure

1. Optional: Display the network interfaces to identify the one for which you want to receive all traffic:

```
# ip address show
1: enp1s0: <NO-CARRIER,BROADCAST,MULTICAST,UP> mtu 1500 qdisc fq_codel state
DOWN group default qlen 1000
    link/ether 98:fa:9b:a4:34:09 brd ff:ff:ff:ff:ff:ff
    ...
```

You can create a new connection, if you do not have any.

2. Modify the network device to enable or disable this property.

- To enable the **ethernet.accept-all-mac-addresses** mode for **enp1s0**:

```
# nmcli connection modify enp1s0 ethernet.accept-all-mac-addresses yes
```

- To disable the **accept-all-mac-addresses** mode for **enp1s0**:

```
# nmcli connection modify enp1s0 ethernet.accept-all-mac-addresses no
```

3. Apply the changes, reactivate the connection:

```
# nmcli connection up enp1s0
```

### Verification

- Verify that the **ethernet.accept-all-mac-addresses** mode is enabled:

```
# nmcli connection show enp1s0
...
802-3-ethernet.accept-all-mac-addresses:1 (true)
```

The **802-3-ethernet.accept-all-mac-addresses: true** indicates that the mode is enabled.

## 46.3. PERMANENTLY CONFIGURING A NETWORK DEVICE TO ACCEPT ALL TRAFFIC USING NMSTATECTL

Use the **nmstatectl** utility to configure a device to accept all traffic regardless of the MAC addresses through the Nmstate API. The Nmstate API ensures that, after setting the configuration, the result matches the configuration file. If anything fails, **nmstatectl** automatically rolls back the changes to avoid leaving the system in an incorrect state.

## Prerequisites

- The **nmstate** package is installed.
- The **enp1s0.yml** file that you used to configure the device is available.

## Procedure

1. Edit the existing **enp1s0.yml** file for the **enp1s0** connection and add the following content to it:

```
---  
interfaces:  
  - name: enp1s0  
    type: ethernet  
    state: up  
    accept-all-mac-address: true
```

These settings configure the **enp1s0** device to accept all traffic.

2. Apply the network settings:

```
# nmstatectl apply ~/enp1s0.yml
```

## Verification

- Verify that the **802-3-ethernet.accept-all-mac-addresses** mode is enabled:

```
# nmstatectl show enp1s0  
interfaces:  
  - name: enp1s0  
    type: ethernet  
    state: up  
    accept-all-mac-addresses: true  
...
```

The **802-3-ethernet.accept-all-mac-addresses: true** indicates that the mode is enabled.

## Additional resources

- **nmstatectl(8)** man page
- **/usr/share/doc/nmstate/examples/** directory

## CHAPTER 47. MIRRORING A NETWORK INTERFACE BY USING NMCLI

Network administrators can use port mirroring to replicate inbound and outbound network traffic being communicated from one network device to another. Mirroring traffic of an interface can be helpful in the following situations:

- To debug networking issues and tune the network flow
- To inspect and analyze the network traffic
- To detect an intrusion

### Prerequisites

- A network interface to mirror the network traffic to.

### Procedure

1. Add a network connection profile that you want to mirror the network traffic from:

```
# nmcli connection add type ethernet ifname enp1s0 con-name enp1s0 autoconnect
no
```

2. Attach a **prio qdisc** to **enp1s0** for the egress (outgoing) traffic with the **10:** handle:

```
# nmcli connection modify enp1s0 +tc.qdisc "root prio handle 10:"
```

The **prio qdisc** attached without children allows attaching filters.

3. Add a **qdisc** for the ingress traffic, with the **ffff:** handle:

```
# nmcli connection modify enp1s0 +tc.qdisc "ingress handle ffff:"
```

4. Add the following filters to match packets on the ingress and egress **qdiscs**, and to mirror them to **enp7s0**:

```
# nmcli connection modify enp1s0 +tc.tfilter "parent ffff: matchall action mirrored egress
mirror dev enp7s0"
```

```
# nmcli connection modify enp1s0 +tc.tfilter "parent 10: matchall action mirrored egress
mirror dev enp7s0"
```

The **matchall** filter matches all packets, and the **mirrored** action redirects packets to destination.

5. Activate the connection:

```
# nmcli connection up enp1s0
```

### Verification

1. Install the **tcpdump** utility:

```
# yum install tcpdump
```

2. Display the traffic mirrored on the target device (**enp7s0**):

```
# tcpdump -i enp7s0
```

#### Additional resources

- [How to capture network packets using tcpdump](#)

# CHAPTER 48. USING NMSTATE-AUTOCONF TO AUTOMATICALLY CONFIGURE THE NETWORK STATE USING LLDP

Network devices can use the Link Layer Discovery Protocol (LLDP) to advertise their identity, capabilities, and neighbors in a LAN. The **nmstate-autoconf** utility can use this information to automatically configure local network interfaces.



## IMPORTANT

The **nmstate-autoconf** utility is provided as a Technology Preview only. Technology Preview features are not supported with Red Hat production Service Level Agreements (SLAs), might not be functionally complete, and Red Hat does not recommend using them for production. These previews provide early access to upcoming product features, enabling customers to test functionality and provide feedback during the development process.

See [Technology Preview Features Support Scope](#) on the Red Hat Customer Portal for information about the support scope for Technology Preview features.

## 48.1. USING NMSTATE-AUTOCONF TO AUTOMATICALLY CONFIGURE NETWORK INTERFACES

The **nmstate-autoconf** utility uses LLDP to identify the VLAN settings of interfaces connected to a switch to configure local devices.

This procedure assumes the following scenario and that the switch broadcasts the VLAN settings using LLDP:

- The **enp1s0** and **enp2s0** interfaces of the RHEL server are connected to switch ports that are configured with VLAN ID **100** and VLAN name **prod-net**.
- The **enp3s0** interface of the RHEL server is connected to a switch port that is configured with VLAN ID **200** and VLAN name **mgmt-net**.

The **nmstate-autoconf** utility then uses this information to create the following interfaces on the server:

- **bond100** - A bond interface with **enp1s0** and **enp2s0** as ports.
- **prod-net** - A VLAN interface on top of **bond100** with VLAN ID **100**.
- **mgmt-net** - A VLAN interface on top of **enp3s0** with VLAN ID **200**

If you connect multiple network interfaces to different switch ports for which LLDP broadcasts the same VLAN ID, **nmstate-autoconf** creates a bond with these interfaces and, additionally, configures the common VLAN ID on top of it.

### Prerequisites

- The **nmstate** package is installed.
- LLDP is enabled on the network switch.
- The Ethernet interfaces are up.

## Procedure

1. Enable LLDP on the Ethernet interfaces:
  - a. Create a YAML file, for example `~/enable-lldp.yml`, with the following content:

```
interfaces:
- name: enp1s0
  type: ethernet
  lldp:
    enabled: true
- name: enp2s0
  type: ethernet
  lldp:
    enabled: true
- name: enp3s0
  type: ethernet
  lldp:
    enabled: true
```

- b. Apply the settings to the system:

```
# nmstatectl apply ~/enable-lldp.yml
```

2. Configure the network interfaces using LLDP:
  - a. Optional, start a dry-run to display and verify the YAML configuration that **nmstate-autoconf** generates:

```
# nmstate-autoconf -d enp1s0,enp2s0,enp3s0
---
interfaces:
- name: prod-net
  type: vlan
  state: up
  vlan:
    base-iface: bond100
    id: 100
- name: mgmt-net
  type: vlan
  state: up
  vlan:
    base-iface: enp3s0
    id: 200
- name: bond100
  type: bond
  state: up
  link-aggregation:
    mode: balance-rr
  port:
    - enp1s0
    - enp2s0
```

- b. Use **nmstate-autoconf** to generate the configuration based on information received from LLDP, and apply the settings to the system:

■



```
# nmstate-autoconf enp1s0,enp2s0,enp3s0
```

### Next steps

- If there is no DHCP server in your network that provides the IP settings to the interfaces, configure them manual. For details, see:
  - [Configuring an Ethernet connection](#)
  - [Configuring network bonding](#)

### Verification

1. Display the settings of the individual interfaces:

```
# nmstatectl show <interface_name>
```

### Additional resources

- [nmstate-autoconf\(8\)](#) man page

## CHAPTER 49. CONFIGURING 802.3 LINK SETTINGS

Auto-negotiation is a feature of the IEEE 802.3u Fast Ethernet protocol. It targets the device ports to provide an optimal performance of speed, duplex mode, and flow control for information exchange over a link. Using the auto-negotiation protocol, you have optimal performance of data transfer over the Ethernet.



### NOTE

To utilize maximum performance of auto-negotiation, use the same configuration on both sides of a link.

### 49.1. CONFIGURING 802.3 LINK SETTINGS USING THE NMCLI UTILITY

To configure the 802.3 link settings of an Ethernet connection, modify the following configuration parameters:

- **802-3-ethernet.auto-negotiate**
- **802-3-ethernet.speed**
- **802-3-ethernet.duplex**

#### Procedure

1. Display the current settings of the connection:

```
# nmcli connection show Example-connection
...
802-3-ethernet.speed: 0
802-3-ethernet.duplex: --
802-3-ethernet.auto-negotiate: no
...
```

You can use these values if you need to reset the parameters in case of any problems.

2. Set the speed and duplex link settings:

```
# nmcli connection modify Example-connection 802-3-ethernet.auto-negotiate yes 802-3-ethernet.speed 10000 802-3-ethernet.duplex full
```

This command enables auto-negotiation and sets the speed of the connection to **10000** Mbit full duplex.

3. Reactivate the connection:

```
# nmcli connection up Example-connection
```

#### Verification

- Use the **ethtool** utility to verify the values of Ethernet interface **enp1s0**:

```
# ethtool enp1s0
```

Settings for enp1s0:

...

Speed: 10000 Mb/s

Duplex: Full

Auto-negotiation: on

...

Link detected: yes

#### Additional resources

- **nm-settings(5)** man page

## CHAPTER 50. GETTING STARTED WITH DPDK

The data plane development kit (DPDK) provides libraries and network drivers to accelerate packet processing in user space.

Administrators use DPDK, for example, in virtual machines to use Single Root I/O Virtualization (SR-IOV) to reduce latencies and increase I/O throughput.



### NOTE

Red Hat does not support experimental DPDK APIs.

### 50.1. INSTALLING THE DPDK PACKAGE

To use DPDK, install the **dpdk** package.

#### Procedure

- Use the **yum** utility to install the **dpdk** package:

```
# yum install dpdk
```

### 50.2. ADDITIONAL RESOURCES

- [Network Adapter Fast Datapath Feature Support Matrix](#)

## CHAPTER 51. GETTING STARTED WITH TIPC

Transparent Inter-process Communication (TIPC), which is also known as **Cluster Domain Sockets**, is an Inter-process Communication (IPC) service for cluster-wide operation.

Applications that are running in a high-available and dynamic cluster environment have special needs. The number of nodes in a cluster can vary, routers can fail, and, due to load balancing considerations, functionality can be moved to different nodes in the cluster. TIPC minimizes the effort by application developers to deal with such situations, and maximizes the chance that they are handled in a correct and optimal way. Additionally, TIPC provides a more efficient and fault-tolerant communication than general protocols, such as TCP.

### 51.1. THE ARCHITECTURE OF TIPC

TIPC is a layer between applications using TIPC and a packet transport service (**bearer**), and spans the level of transport, network, and signaling link layers. However, TIPC can use a different transport protocol as bearer, so that, for example, a TCP connection can serve as a bearer for a TIPC signaling link.

TIPC supports the following bearers:

- Ethernet
- InfiniBand
- UDP protocol

TIPC provides a reliable transfer of messages between TIPC ports, that are the endpoints of all TIPC communication.

The following is a diagram of the TIPC architecture:

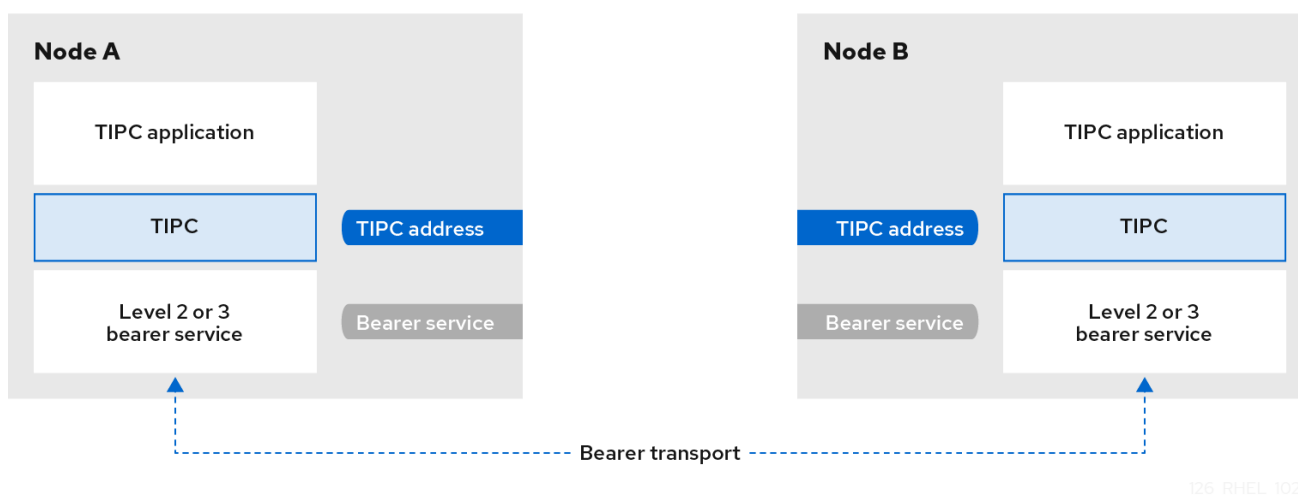

### 51.2. LOADING THE TIPC MODULE WHEN THE SYSTEM BOOTS

Before you can use the TIPC protocol, you must load the **tipc** kernel module. You can configure Red Hat Enterprise Linux to automatically load this kernel module automatically when the system boots.

#### Procedure

1. Create the `/etc/modules-load.d/tipc.conf` file with the following content:

```
tipc
```

- Restart the **systemd-modules-load** service to load the module without rebooting the system:

```
# systemctl start systemd-modules-load
```

### Verification

- Use the following command to verify that RHEL loaded the **tipc** module:

```
# lsmod | grep tipc
tipc 311296 0
```

If the command shows no entry for the **tipc** module, RHEL failed to load it.

### Additional resources

- **modules-load.d(5)** man page

## 51.3. CREATING A TIPC NETWORK

To create a TIPC network, perform this procedure on each host that should join the TIPC network.



### IMPORTANT

The commands configure the TIPC network only temporarily. To permanently configure TIPC on a node, use the commands of this procedure in a script, and configure RHEL to execute that script when the system boots.

### Prerequisites

- The **tipc** module has been loaded. For details, see [Loading the tipc module when the system boots](#)

### Procedure

- Optional: Set a unique node identity, such as a UUID or the node's host name:

```
# tipc node set identity host_name
```

The identity can be any unique string consisting of a maximum 16 letters and numbers.

You cannot set or change an identity after this step.

- Add a bearer. For example, to use Ethernet as media and **enp0s1** device as physical bearer device, enter:

```
# tipc bearer enable media eth device enp1s0
```

- Optional: For redundancy and better performance, attach further bearers using the command from the previous step. You can configure up to three bearers, but not more than two on the same media.

- Repeat all previous steps on each node that should join the TIPC network.

### Verification

- Display the link status for cluster members:

```
# tipc link list
broadcast-link: up
5254006b74be:enp1s0-525400df55d1:enp1s0: up
```

This output indicates that the link between bearer **enp1s0** on node **5254006b74be** and bearer **enp1s0** on node **525400df55d1** is **up**.

- Display the TIPC publishing table:

```
# tipc nametable show
Type   Lower   Upper   Scope  Port   Node
0      1795222054 1795222054 cluster 0      5254006b74be
0      3741353223 3741353223 cluster 0      525400df55d1
1      1         1       node   2399405586 5254006b74be
2      3741353223 3741353223 node   0       5254006b74be
```

- The two entries with service type **0** indicate that two nodes are members of this cluster.
- The entry with service type **1** represents the built-in topology service tracking service.
- The entry with service type **2** displays the link as seen from the issuing node. The range limit **3741353223** represents the peer endpoint's address (a unique 32-bit hash value based on the node identity) in decimal format.

### Additional resources

- tipc-bearer(8)** man page
- tipc-namespace(8)** man page

## 51.4. ADDITIONAL RESOURCES

- Red Hat recommends to use other bearer level protocols to encrypt the communication between nodes based on the transport media. For example:
  - MACSec: See [Using MACsec to encrypt layer 2 traffic](#)
  - IPsec: See [Configuring a VPN with IPsec](#)
- For examples of how to use TIPC, clone the upstream GIT repository using the **git clone git://git.code.sf.net/p/tipc/tipcutils** command. This repository contains the source code of demos and test programs that use TIPC features. Note that this repository is not provided by Red Hat.
- /usr/share/doc/kernel-doc-<kernel\_version>/Documentation/output/networking/tipc.html** provided by the **kernel-doc** package.

## CHAPTER 52. AUTOMATICALLY CONFIGURING NETWORK INTERFACES IN PUBLIC CLOUDS USING NM-CLOUD-SETUP

Usually, a virtual machine (VM) has only one interface that is configurable by DHCP. However, DHCP cannot configure VMs with multiple network entities, such as interfaces, IP subnets, and IP addresses. Additionally, you cannot apply settings when the VM instance is running. To solve this runtime configuration issue, the **nm-cloud-setup** utility automatically retrieves configuration information from the metadata server of the cloud service provider and updates the network configuration of the host. The utility automatically picks up multiple network interfaces, multiple IP addresses, or IP subnets on one interface and helps to reconfigure the network of the running VM instance.

### 52.1. CONFIGURING AND PRE-DEPLOYING NM-CLOUD-SETUP

To enable and configure network interfaces in public clouds, run **nm-cloud-setup** as a timer and service.



#### NOTE

On Red Hat Enterprise Linux On Demand and AWS golden images, **nm-cloud-setup** is already enabled and no action is required.

#### Prerequisite

- A network connection exists.
- The connection uses DHCP.  
By default, NetworkManager creates a connection profile which uses DHCP. If no profile was created because you set the **no-auto-default** parameter in **/etc/NetworkManager/NetworkManager.conf**, create this initial connection manually.

#### Procedure

1. Install the **nm-cloud-setup** package:

```
# yum install NetworkManager-cloud-setup
```

2. Create and run the snap-in file for the **nm-cloud-setup** service:

- a. Use the following command to start editing the snap-in file:

```
# systemctl edit nm-cloud-setup.service
```

It is important to either start the service explicitly or reboot the system to make configuration settings effective.

- b. Use the **systemd** snap-in file to configure the cloud provider in **nm-cloud-setup**. For example, to use Amazon EC2, enter:

```
[Service]
Environment=NM_CLOUD_SETUP_EC2=yes
```

You can set the following environment variables to enable the cloud provide you use:

- **NM\_CLOUD\_SETUP\_AZURE** for Microsoft Azure



- **NM\_CLOUD\_SETUP\_EC2** for Amazon EC2 (AWS)
- **NM\_CLOUD\_SETUP\_GCP** for Google Cloud Platform(GCP)
- **NM\_CLOUD\_SETUP\_ALIYUN** for Alibaba Cloud (Aliyun)

c. Save the file and quit the editor.

3. Reload the **systemd** configuration:

```
# systemctl daemon-reload
```

4. Enable and start the **nm-cloud-setup** service:

```
# systemctl enable --now nm-cloud-setup.service
```

5. Enable and start the **nm-cloud-setup** timer:

```
# systemctl enable --now nm-cloud-setup.timer
```

#### Additional resources

- **nm-cloud-setup(8)** man page
- [Configuring an Ethernet connection](#)

## 52.2. UNDERSTANDING THE ROLE OF IMDSV2 AND NM-CLOUD-SETUP IN THE RHEL EC2 INSTANCE

The instance metadata service (IMDS) in Amazon EC2 allows you to manage permissions to access instance metadata of a running Red Hat Enterprise Linux (RHEL) EC2 instance. The RHEL EC2 instance uses IMDS version 2 (IMDSv2), a session-oriented method. By using the **nm-cloud-setup** utility, administrators can reconfigure the network and automatically update the configuration of running RHEL EC2 instances. The **nm-cloud-setup** utility handles IMDSv2 API calls by using IMDSv2 tokens without any user intervention.

- IMDS runs on a link-local address **169.254.169.254** for providing access to native applications on a RHEL EC2 instance.
- After you have specified and configured IMDSv2 for each RHEL EC2 instance for applications and users, you can no longer access IMDSv1.
- By using IMDSv2, the RHEL EC2 instance maintains metadata without using the IAM role while remaining accessible through the IAM role.
- When the RHEL EC2 instance boots, the **nm-cloud-setup** utility automatically runs to fetch the EC2 instance API access token for using the RHEL EC2 instance API.



#### NOTE

Use the IMDSv2 token as an HTTP header to check the details of the EC2 environment.

#### Additional resources

- **nm-cloud-setup(8)** man page